

JMR-5404-X

JMR-5406-X

JMR-5410-4X/4XH

/6X/6XH

JMR-5425-6XH/7X/9X

JMR-5430-S

JMR-5472-S

JMR-5482-S/SH

**MARINE RADAR
EQUIPMENT**

**INSTRUCTION
MANUAL**

PREFACE

Thank you for purchasing the JRC Multi Function Display JMR-5400 Series.

This equipment meets the performance standards of the IMO (International Maritime Organisation), and serves to improve safety.

- For the best operation, read this manual thoroughly before use.
- Keep this manual in a convenient place for future reference.
Make use of this manual when experiencing operation difficulties.
- The LCD of this equipment uses thin film transistors (TFT). If some pixels on the screen are not clear, the colour is different, or the screen is brighter than usual, it is not because of defect, instead it is because of inherent characteristic of the TFT display technology.
- The information in this manual is subject to change without notice at any time.

● Safety Cautions ●

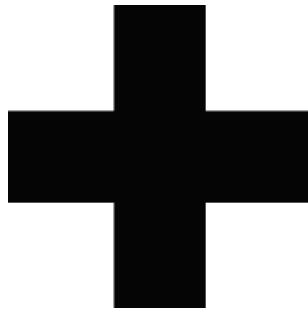

Cautions for High Voltage

High voltages, ranging from several hundreds to tens of thousands of volts, are used in electronic apparatus, such as radio and radar instruments. These voltages are totally harmless in most operations. However, touching a component inside the unit is very dangerous. (Any person other than authorized service engineers should not maintain, inspect, or adjust the unit.) High voltages on the order of tens of thousand volts are most likely to cause instant deaths from electrical shocks. At times, even voltages on the order of several hundred volts could lead to electrocution. To defend against electrical shock hazards, don't put your hand into the inside of apparatus.

When you put in a hand unavoidably in case of urgent, it is strongly suggested to turn off the power switch and allow the capacitors, etc. to discharge with a wire having its one end positively grounded to remove residual charges. Before you put your hand into the inside of apparatus, make sure that internal parts are no longer charged. Extra protection is ensured by wearing dry cotton gloves at this time. Another important precaution to observe is to keep one hand in your pocket at a time, instead of using both hands at the same time. It is also important to select a secure footing to work on, as the secondary effects of electrical shock hazards can be more serious. In the event of electrical shocks, disinfect the burnt site completely and obtain medical care immediately.

Precautions for Rescue of Victim of Electric Shock

When a victim of electric shock is found, turn off the power source and ground the circuit immediately. If this is impossible, move the victim away from the unit as quick as possible without touching him or her with bare hands. He or she can safely be moved if an insulating material such as dry wood plate or cloth is used.

It is necessary to perform first aid immediately.

Breathing may stop if current flows through the respiration centre of brain due to electric shock. If the electric shock is not large, breathing can be restored by artificial respiration. A victim of electric shock looks pale and his or her pulse may become very weak or stop, resulting in unconsciousness and rigidity at worst.

● Emergency Measures ●

Method of First-Aid Treatment

☆ Precautions for First-Aid Treatments

Apply artificial respiration to the person who collapsed, minimising moving as much as possible avoiding risks. Once started, artificial respiration should be continued rhythmically.

- (1) Refrain from touching the patient carelessly as a result of the accident; the first-aider could suffer from electrical shocks by himself or herself.
- (2) Turn off the power calmly and certainly, and move the patient apart from the cable gently.
- (3) Call or send for a physician or ambulance immediately, or ask someone to call doctor.
- (4) Lay the patient on the back, loosening the necktie, clothes, belts and so on.
- (5)
 - (a) Feel the patient's pulse.
 - (b) Check the heartbeat by bringing your ear close to the patient's heart.
 - (c) Check for respiration by bringing your face or the back of your hand to the patient's face.
 - (d) Check the size of patient's pupils.
- (6) Opening the patient's mouth, remove artificial teeth, cigarettes, chewing gum, etc. if any. With the patient's mouth open, stretch the tongue and insert a towel or the like into the mouth to prevent the tongue from being withdrawn into the throat. (If the patient clenches the teeth so tight that the mouth won't open, use a screwdriver or the like to force the mouth open and then insert a towel or the like into the mouth.)
- (7) Wipe off the mouth to prevent foaming mucus and saliva from accumulating.

★ Treatment to Give When the Patient Has a Pulse Beating but Has Ceased to Breathe

* Performing mouth-to-mouth artificial respiration

- (1) Bend the patient's face backward until it is directed to look back. (A pillow may be placed under the neck.)
- (2) Pull up the lower jaw to open up the airway. (To spread the airway)
- (3) Pinching the patient's nose, breathe deeply and blow your breath into the patient's mouth strongly, with care to close it completely. Then, move your mouth away and take a deep breath, and blow into his or her mouth. Repeat blowing at 10 to 15 times a minute (always with the patient's nostrils closed).
- (4) Continue artificial respiration until natural respiration is restored.
- (5) If the patient's mouth won't open easily, insert a pipe, such as one made of rubber or vinyl, into either nostril. Then, take a deep breath and blow into the nostril through the pipe, with the other nostril and the mouth completely closed.
- (6) The patient may stand up abruptly upon recovering consciousness. Keep the patient lying calmly, giving him or her coffee, tea or any other hot drink (but not alcoholic drink) to keep him or her warm.

Mouth-to-mouth artificial respiration with the patient's head lifted



- [1]  (1) Lift the back part of the patient's head. Support the forehead with one of your hand and the neck with the other hand. → [1].
Many patients will have their airways opened by lifting their head in this way to ease mouth-to-mouth artificial respiration.
- [2]  (2) Closing the patient's mouth with your mouth, press your cheek against the patient's nose → [2].
Alternatively, hold the patient's nose with your finger to prevent air leak → [3].
- [3]  (3) Blowing air into the patient's lungs. Blow air into the patient's lungs until chest is seen to rise. The first 10 breaths must be blown as fast as possible.

Fig. 1 Mouth-to-mouth artificial respiration

Flow of Cardiopulmonary Resuscitation (CPR)

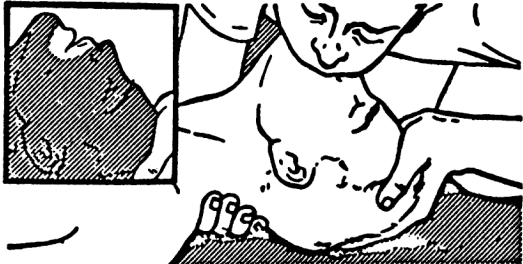

Note(1) Combination of chest compressions and rescue breaths

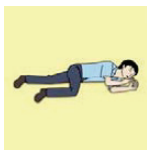
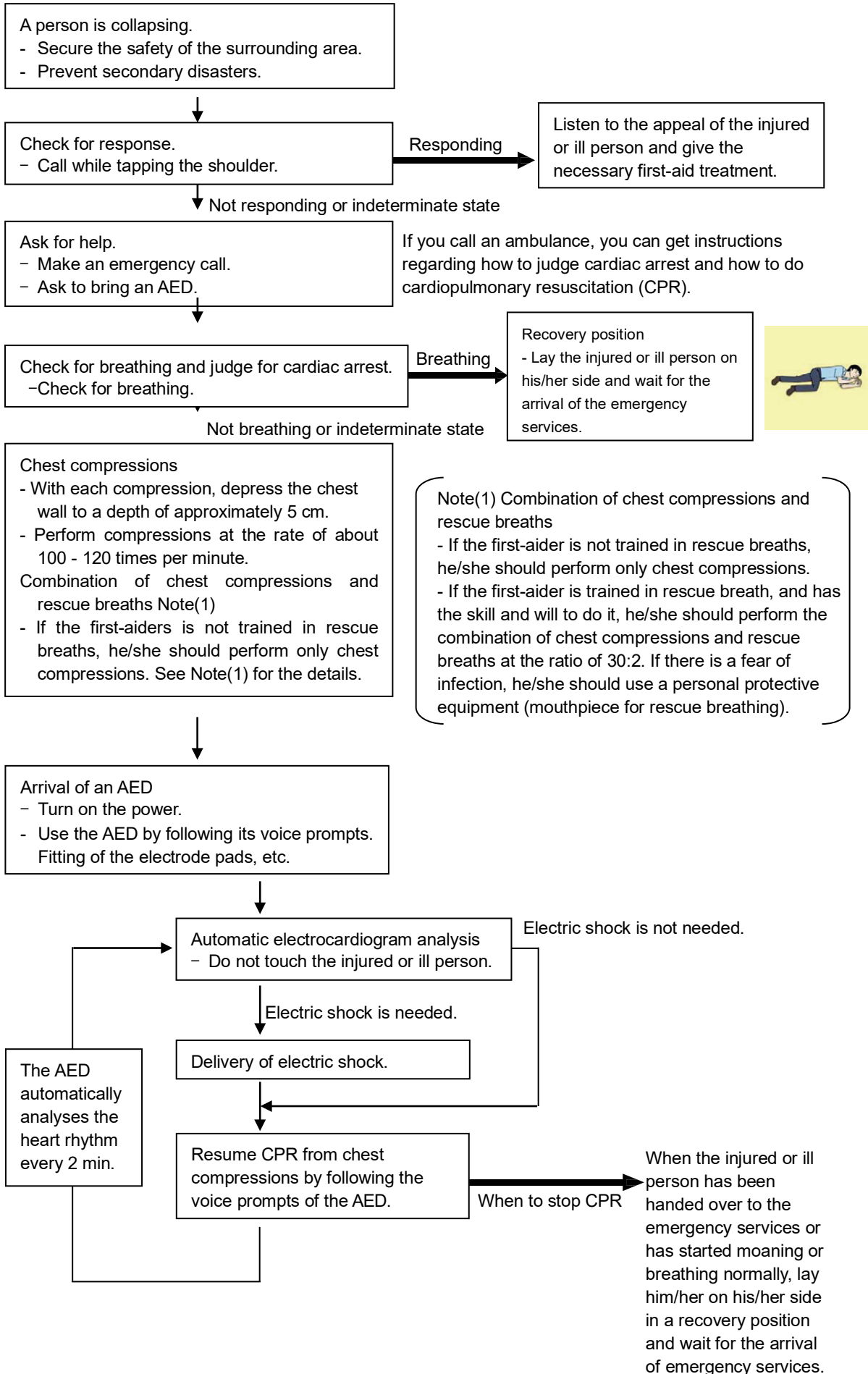
- If the first-aiders is not trained in rescue breaths, he/she should perform only chest compressions.
- If the first-aiders is trained in rescue breath, and has the skill and will to do it, he/she should perform the combination of chest compressions and rescue breaths at the ratio of 30:2. If there is a fear of infection, he/she should use a personal protective equipment (mouthpiece for rescue breathing).

Specific Procedures for Cardiopulmonary Resuscitation (CPR)

1. Check the scene for safety to prevent secondary disasters

- a) Do not touch the injured or ill person in panic when an accident has occurred. (Doing so may cause electric shock to the first-aiders.)
- b) Do not panic and be sure to turn off the power. Then, gently move the injured or ill person to a safe place away from the electrical circuit.



2. Check for responsiveness

- a) Tap the shoulder of the injured or ill and shout in the ear saying, "Are you OK?"
- b) If the person opens his/her eyes or there is some response or gesture, determine it as "responding." But, if there is no response or gesture, determine it as "not responding."

3. If responding

- a) Give first-aid treatment.

4. If not responding

- a) Ask for help loudly. Ask somebody to make an emergency call and bring an AED.
 - Somebody has collapsed. Please help.
 - Please call an ambulance.
 - Please bring an AED.
 - If there is nobody to help, call an ambulance yourself.

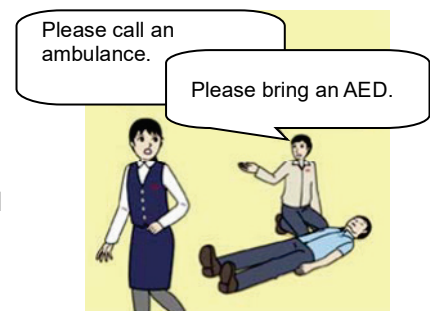

5. Check for breathing

- a) Look to see if the chest and abdomen of the injured or ill person are rising and falling.

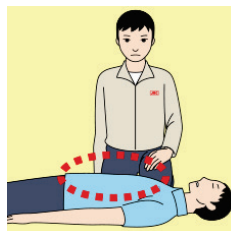

- b) If the injured or ill person is breathing, place him/her in the recovery position and wait for the arrival of the emergency services.
 - Position the injured or ill person on his/her side.

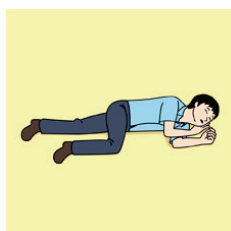

6. Cardiopulmonary resuscitation (CPR) (combination of chest compressions and rescue breaths)

a) Chest compressions

1) Position of chest compressions

- Position the heel of one hand in the center of the chest, approximately between the nipples, and place your other hand on top of the one that is in position.

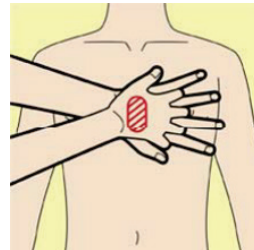
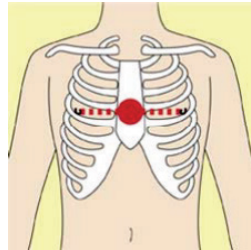

2) Perform chest compressions

- Perform 30 times uninterrupted chest compressions at the rate of about 100 - 120 times per minute, while locking your elbows positioning yourself vertically above your hands.
- With each compression, depress the chest wall to a depth of approximately 5 cm.

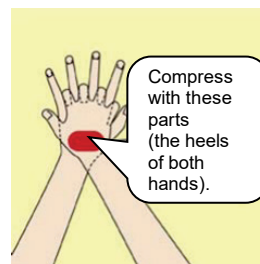

b) Combination of 30 times chest compressions and 2 times rescue breaths

- 1) If the first-aiders is not trained in rescue breaths, he/she should perform only chest compressions.
- 2) If the first-aiders is trained in rescue breath, and has the skill and will to do it, he/she should perform 30 chest compressions, then give 2 rescue breaths.
- 3) If there is a fear of infection, he/she should use a personal protective equipment (mouthpiece for rescue breathing).
- 4) Continuously perform the combination of 30 chest compressions and 2 rescue breaths without interruption.
- 5) If there are two or more first-aiders, alternate with each other approximately every two minutes (five cycles) without interruption.

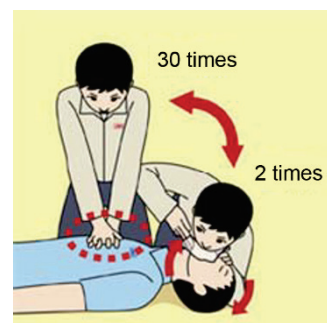
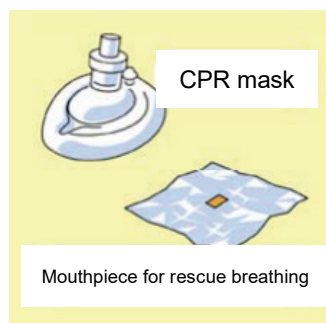

7. When to stop cardiopulmonary resuscitation (CPR)

- a) When the injured or ill person has been handed over to the emergency services.
- b) When the injured or ill person has started moaning or breathing normally, lay him/her on his/her side in a recovery position and wait for the arrival of emergency services.

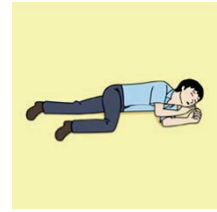

8. Arrival and preparation of an AED

- a) Place the AED at an easy-to-use position.
If there are multiple first-aiders, continue CPR until the AED becomes ready.
- b) Turn on the power to the AED unit. Depending on the model of the AED, you may have to push the power on button, or the AED automatically turns on when you open the cover.
- c) Follow the voice prompts of the AED.



9. Attach the electrode pads to the injured or ill person's bare chest

- a) Remove all clothing from the chest, abdomen, and arms.
- b) Open the package of electrode pads, peel the pads off and securely place them on the chest of the injured or ill person, with the adhesive side facing the chest. If the pads are not securely attached to the chest, the AED may not function. Paste the pads exactly at the positions indicated on the pads. If the chest is wet with water, wipe dry with a dry towel and the like, and then paste the pads. If there is a pacemaker or implantable cardioverter defibrillator (ICD), paste the pads at least 3cm away from them. If a medical patch or plaster is present, peel it off and then paste the pads. If the injured or ill person's chest hair is thick, paste the pads on the chest hair once, peel them off to remove the chest hair, and then paste new pads.
- c) Some AED models require to connect a connector by following voice prompts.
- d) The electrode pads for small children should not be used for children over the age of 8 and for adults.

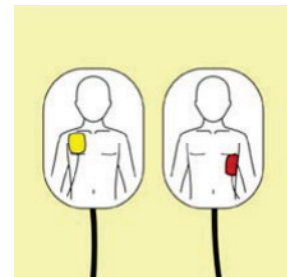

10. Electric shock (defibrillation)

- a) If the AED determines that electric shock is needed, the voice prompt saying, "Shock is needed" is issued and charging starts automatically.
- b) When charging is completed, the voice prompt saying, "Press the shock button" is issued and the shock button flashes.
- c) The first-aider must get away from the injured or ill person, make sure that no one is touching him/her, and then press the shock button.
- d) When electric shock is delivered, the body of the injured or ill person may jerk.

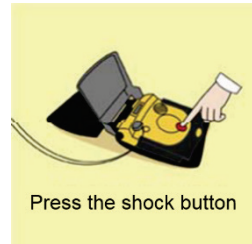

11. Resume chest compressions

- a) Resume chest compressions by following the voice prompts of the AED.
 - With each compression, depress the chest wall to a depth of approximately 5 cm.
 - Perform compressions at the rate of about 100 - 120 times per minute.



12. Automatic electrocardiogram analysis

- a) When 2 minutes have elapsed since you resumed cardiopulmonary resuscitation (CPR), the AED automatically analyzes the electrocardiogram.
- b) If you suspended CPR by following voice prompts and AED voice prompt informs you that shock is needed, give electric shock again by following the voice prompts.
If AED voice prompt informs you that no shock is needed, immediately resume CPR.

13. When to stop CPR (Keep the electrode pads on.)

- a) When the injured or ill person has been handed over to the emergency services
- b) When the injured or ill person has started moaning or breathing normally, lay him/her on his/her side in a recovery position and wait for the arrival of emergency services.

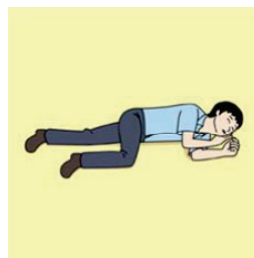



● Pictorial Indication ●

Meanings of Pictorial Indication

Various pictorial indications are included in this manual and are shown on this equipment so that you can operate them safely and correctly and prevent any danger to you and / or to other persons and any damage to your property during operation. Such indications and their meanings are as follows.

Please understand them before you read this manual:

| | |
|---|---|
|  DANGER | This indication is shown where incorrect equipment operation due to negligence may cause death or serious injuries. |
|  WARNING | This indication is shown where any person is supposed to be in danger of being killed or seriously injured if this indication is neglected and this equipment is not operated correctly. |
|  CAUTION | This indication is shown where any person is supposed to be injured or any property damage is supposed to occur if this indication is neglected and this equipment is not operated correctly. |

Examples of Pictorial Indication



Electric Shock

The △ mark represents CAUTION (including DANGER and WARNING).

Detailed contents of CAUTION ("Electric Shock" in the example on the left) is shown in the mark.



Disassembling
Prohibited



The ⊘ mark represents prohibition.

Detailed contents of the prohibited action ("Disassembling Prohibited" in the example on the left) is shown in the mark.



Disconnect
the power plug



The ● mark represents instruction.

Detailed contents of the instruction ("Disconnect the power plug" in the example on the left) is shown in the mark.

Warning Label

There is a warning label on the top cover of the equipment. Do not try to remove, break or modify the label.

● Precautions upon Equipment Operation ●

DANGER



Never attempt to check or repair the inside of the equipment.
Checking or repair by an unqualified person may cause a fire or an electric shock.
Contact our head office, or a nearby branch or local office to request servicing.



Never remove the cover of this equipment.
Touching the high-voltage section inside will cause an electric shock.



Do not attempt to disassemble or tamper with this equipment.
Otherwise, a fire, an electric shock, or a malfunction may occur.



When conducting maintenance, make sure to turn the main power off.
Failure may result in electric shock.



Turn off all the main powers before cleaning the equipment. Make sure to turn it off since voltage is still outputted from the rectifier even after the indicator and the radar are turned off. Failure may result in equipment failure, or death or serious injury due to electric shock.



When conducting maintenance work on the radar antenna, make sure to turn all the main powers off.
Failure may result in electric shock or injuries.



Make sure to turn off the radar antenna safety switch. Failure may result in injuries caused by physical contact with the rotating radar antenna.

WARNING



When turning off the power supply, do not hold down the power button of the operation unit.
Otherwise, a trouble may occur due to termination failure.



Never directly touch the internal components of the radar antenna or indicator. Direct contact with these high-voltage components may cause electric shock. For maintenance, inspection, or adjustment of equipment components, consult with our branch office, branch shop, sales office, or our distributor in your district.



Do not get close to the radiant section of the radar antenna. It is a rotating part, and it may cause injuries if it suddenly starts rotating and consequently hits the body. The radiant section be installed at a high place such as on the roof of the wheelhouse, on the flying bridge, on the trestle, or on the radar mast so that no one can get close to it.



Microwave radiation level of the radar antenna
Keep away from the radar antenna during transmission.

Microwaves are generated from the front centre of the radiant section of the radar antenna at the levels indicated in the table below. Exposure to microwaves at close range can result in injury (especially damage to eyes).

| System | 50 W/m ² | 10 W/m ² | 2.5 W/m ² |
|------------|---------------------|---------------------|----------------------|
| NKE-2043 | n/a | 40cm | n/a |
| NKE-2063A | n/a | 22cm | n/a |
| NKE-2103 | n/a | 26cm | 123cm |
| NKE-2255 | 5cm | 81cm | 162cm |
| NKE-1130/A | 11cm | 76cm | 181cm |
| NKE-2632/A | 1.4cm | 3.1cm | 209.8cm |
| NKE-1632/A | 1.5cm | 3.3cm | 128.4cm |



Make sure to install the radar antenna at a place higher than human height. Direct exposure to electromagnetic wave at close range will have adverse effects on the human body.



When it is necessary to get close to the radar antenna for maintenance or inspection purposes, make sure to turn the power switch of the display unit to "OFF" or "STBY".
Direct exposure to electromagnetic waves at close range will have adverse effects on the human body.



When conducting maintenance work, make sure to turn off the power so that the power supply to the equipment is completely cut off.
Some equipment components can carry electrical current even after the power switch is turned off, and conducting maintenance work may result in electric shock, equipment failure, or accidents.

WARNING



When cleaning the display screen, do not wipe it too strongly with a dry cloth. Also, do not use gasoline or thinner to clean the screen. Failure will result in damage to the screen surface.



Do not change Initial Level/Area Offset unless absolutely necessary. Incorrect adjustment will result in deletion of nearby target images and thus collisions may occur resulting in death or serious injuries.



Confirm computer virus does not exist in USB flash memory beforehand when reading and writing of the file by using USB flash memory. Influences other equipment when the display unit is infected with the virus, and it may cause a breakdown.



Do not remove USB flash memory while the access lamp (in USB flash drive) is flashing. Data may be damaged when the USB flash memory is inserted or removed while accessing it, and it may cause a breakdown.



Confirm computer virus does not exist in external storage media beforehand when reading and writing of the file by using external storage media. Influences other equipment when the display unit is infected with the virus, and it may cause a breakdown.



In case water or a metal object gets inside the equipment, turn off the power immediately, unplug the power supply cable from an electric outlet, and contact our head office, or a nearby branch or local office to request servicing. Keeping the equipment in operation under such condition may cause a fire, an electric shock or a malfunction.



In case you find smoke, unusual odor or extreme high heat coming from the equipment, turn off the power immediately, unplug the power supply cable from an electric outlet, and contact our head office, or a nearby branch or local office to request servicing. Keeping the equipment in operation under such condition may cause a fire or an electric shock.



Do not use the offset function during navigation. If the equipment is used with the offset value entered as the own ship position (deviated from the actual position), accidents may result.

WARNING



Change of the colour of the Day/Night button, particularly the use of the [Night] colour, may interfere with the recognition of display information. Confirm display information can be recognised.



When moving the dialogue box, move to the position that does not cover the operation area. If the dialogue box covers the operation area, it may interfere the recognition of the display information.



In the short distance range, do not set the sea clutter suppression function so that all reflections from the sea are suppressed. This suppresses not only the echo from waves, etc., but also the echo from floating objects such as ships or dangerous objects, etc., and obstructs their detection. When using the sea clutter suppression function, always make the best suppression setting.



Do not set the rain/snow clutter suppression setting to an excessive level, because not only the echo from rain or snow but also the echo from floating objects such as ships or dangerous objects, etc., and obstructs their detection. When using the rain/snow clutter suppression function, always make the best suppression setting.



When setting a guard zone, make sure to properly adjust gain, sea-surface reflection suppression level, and rain/snow reflection suppression level so that the optimal target images are always on the radar screen. The guard zone alarm will not be activated for targets undetected by the radar, and it may result in accidents such as collisions.



Since these alarms may include some errors depending on the target tracking conditions, the navigation officer himself should make the final decision for ship operations such as collision avoidance. Making the final navigation decision based only on the alarm may cause accidents such as collisions.



Do not turn off the power during Backup/Restore. Otherwise, a function may fail, and an accident may occur.



Do not turn off the power supply during recovery of C drive image. Otherwise, a function fault occurs, causing an accident.



Specify the power source type, taking into account the ship's mains. In the case of using the ship's mains of 440VAC, it may be necessary as a step-down transformer. Improper order or using may result in a fire or accidents.

WARNING



The reference target function is to be used if the own ship's speed cannot be displayed normally due to trouble such as a speed sensor malfunction. Do not use the reference target function except in emergencies.



Do not set as a reference target a large radar echo such as a land target. The vectors of the speed and other tracking targets will not be displayed correctly and may cause an accident.



Do not set as a reference target a sailing ship. The vectors of the speed and other tracking targets will not be displayed correctly and may cause an accident.



Do not use own speed based on reference target tracking for relative speed and CPA/TCPA calculation of AIS targets because the response of own speed is slower than actual own ship's speed change and it may cause a big error on the collision judgement of AIS targets.

CAUTION



Use the radar only as a navigation aid.
The final navigation decision must always be made by the operator him/herself.
Making the final navigation decision based only on the radar display information may cause accidents such as collisions or running aground.



A malfunction as the screen is disordered or unshown may occur if the power in the ship is instantaneously interrupted during operation of the radar. In this case, the power should be turned on again.



The simulation function is used exclusively for deciding whether or not target tracking is properly operating. Therefore, never use this function unless you wish to check target tracking operations.
Note especially that, if this function is used during actual navigation, simulated targets are displayed and may become confused with other actual targets. Therefore, never use this function during actual navigation.



Optimal values have been set for VD Level and Constant; therefore, never change their values unless absolutely necessary. Failure may result in accidents that would lower target tracking performance.



When replacing magnetrons, make sure to shut off the main power and let the equipment stand for more than 5 minutes to discharge the high-voltage circuit.
Failure may result in electric shock.



Make sure to take off your watch when your hand must get close to the magnetron.
Failure may result in damage to the watch since the magnetron is a strong magnet.



Do not make any adjustments during navigation.
Failure may result in adverse effects on the radar function which may lead to accidents or equipment failure.



Do not change the quantization level settings unless absolutely necessary.
If set at an inappropriate value, the acquisition of target tracking function and the tracking function deteriorate, and this may lead to accidents.



Do not use or leave the equipment under direct sunlight for a long time or in the temperatures above 55°C.
Otherwise, a fire or a malfunction may occur.



Do not place a glass or cup containing water, etc., or a small metal object on this equipment.
If water or such object gets inside, a fire, an electric shock, or a malfunction may occur.

CAUTION



Do not touch the equipment with hands or gloves wet with water. Otherwise, an electric shock or a malfunction may occur.



- Do not place any object on the operation panel. In particular, if a hot object is placed on the operation panel, it can cause deformation of the surface of the operation panel.
- Do not apply any undue shock on the operation panel, trackball and dials. Otherwise, a malfunction may result.



Make sure that the main power is turned off before inspection or replacement of parts. Otherwise, an electric shock, a fire, or a malfunction may occur.



Since the image within the previous observation range is displayed by expanding/contracting for the period from immediately after switching of the observation range from the next image updating, do not use this image for navigation. If this image is used for navigation, an accident may occur.



In the case of turning on the power under the condition of low temperature, do pre-heat more than 30 minutes. Otherwise, an operation failure may occur and an accident may occur.



Normally, use the automatic tuning mode. If you use the manual tuning mode, an accident may be caused by a transmission/reception problem. Use the manual tuning mode only when you cannot get the best tuning conditions in the automatic tuning mode.



Always keep the sensitivity adjusted to the best condition. If you raise the sensitivity excessively, the visibility of the target will be reduced by unwanted signals including receiver noise and pseudo image. This may cause an accident. If the sensitivity is reduced excessively, detection of a target such as a ship or hazardous material will be interrupted.



Adjust the preset of the observation scene according to the oceanographic condition, with the thorough understanding of the features of the radar signal processing setting. The optimum radar performance may not be able to be demonstrated due to the contents of the changed setting or the oceanographic condition at that time.



Information is displayed in addition to a warning or a caution in the alert status area. Information is used to report operation errors and so on to the users. Unlike other alerts, no detail display is provided for Information.

CAUTION



Never changes or modifications the equipment by user with not expressly approved method. Otherwise, the party responsible for compliance could void the user's authority to operate the equipment.



This equipment has been tested and found to comply with the limits for a Class A digital device, pursuant to part 15 of the FCC Rules. These limits are designed to provide reasonable protection against harmful interference when the equipment is operated in a commercial environment. This equipment generates, uses, and can radiate radio frequency energy and, if not installed and used in accordance with the instruction manual, may cause harmful interference to radio communications. Operation of this equipment in a residential area is likely to cause harmful interference in which case the user will be required to correct the interference at his own expense.

The Mounting Point of the Warning Label

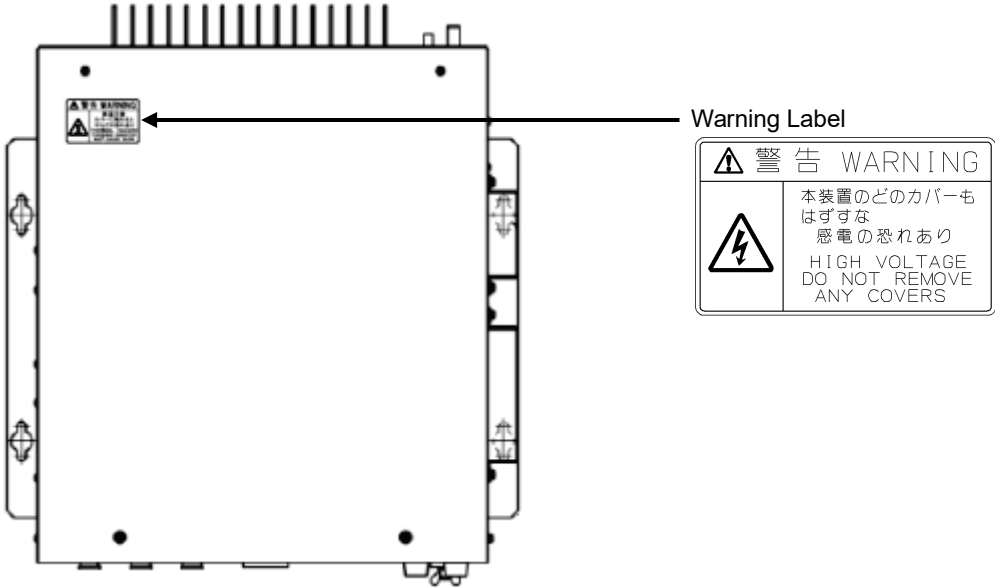

NDC-1678/A Processing Unit (top panel)

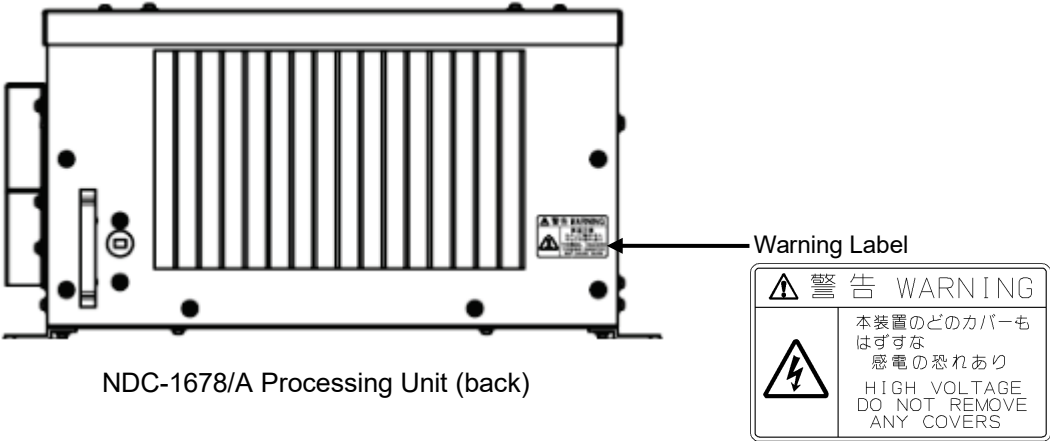

NDC-1678/A Processing Unit (back)

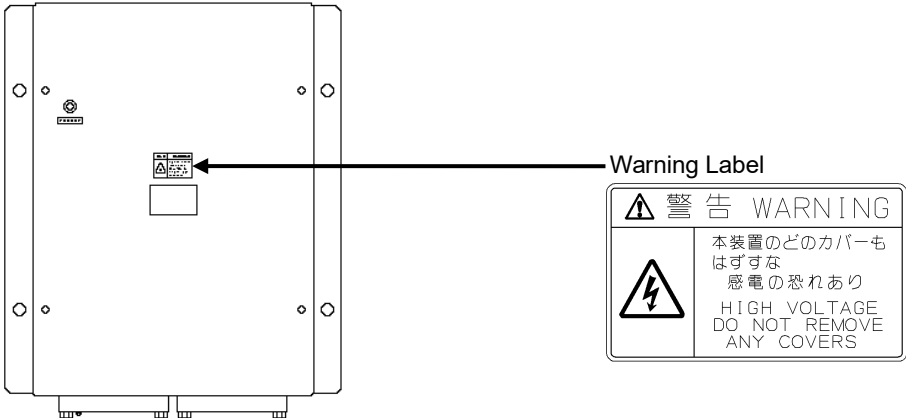

NQE-3141-4A/8A Interswitch Unit

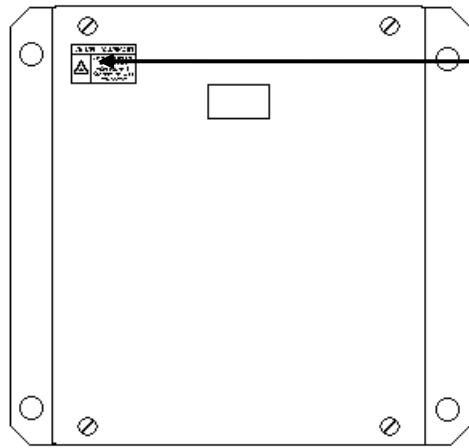

Warning Label



NQE-3167 Power Control Unit

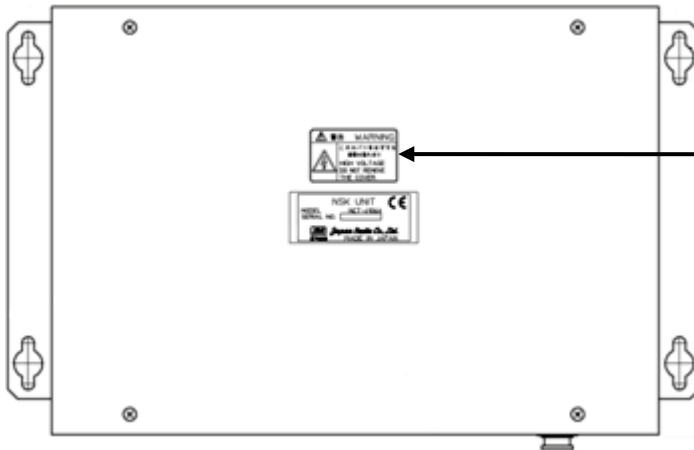

Warning Label



NCT-4106A NSK Unit

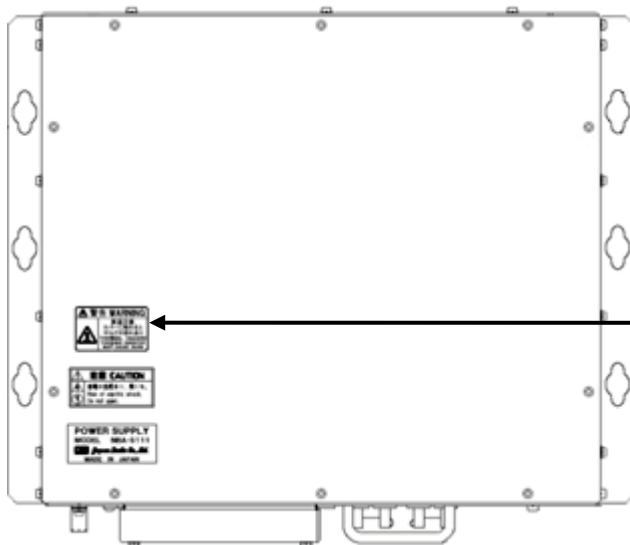

Warning Label



NBA-5111 Rectifier

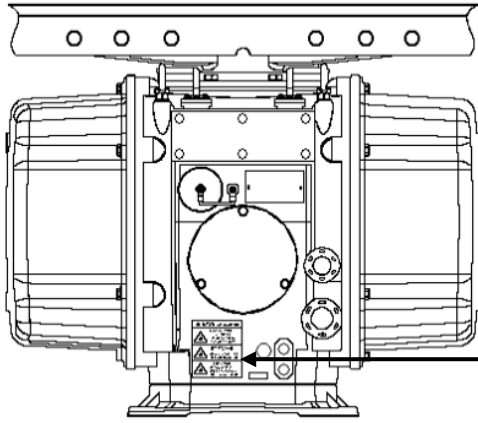

NKE-1130/A Scanner Unit

Warning Label

| | |
|--|---|
| | 警告 WARNING |
| | このカバーをはずすな 感電の恐れあり HIGH VOLTAGE DO NOT REMOVE THE COVER |
| | 空中線の回転に注意 負傷の恐れあり SCANNER ROTATION DO NOT APPROACH |
| | 送信中は近づくな 電磁波被害の恐れあり RADIATION HAZARD DO NOT APPROACH |

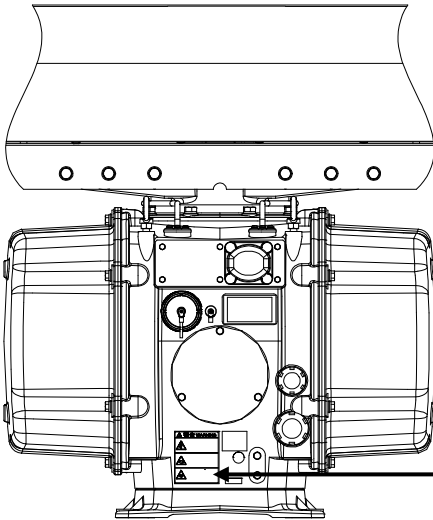

NKE-1632/A Scanner Unit

Warning Label

| | |
|--|---|
| | 警告 WARNING |
| | このカバーをはずすな 感電の恐れあり HIGH VOLTAGE DO NOT REMOVE THE COVER |
| | 空中線の回転に注意 負傷の恐れあり SCANNER ROTATION DO NOT APPROACH |
| | 送信中は近づくな 電磁波被害の恐れあり RADIATION HAZARD DO NOT APPROACH |

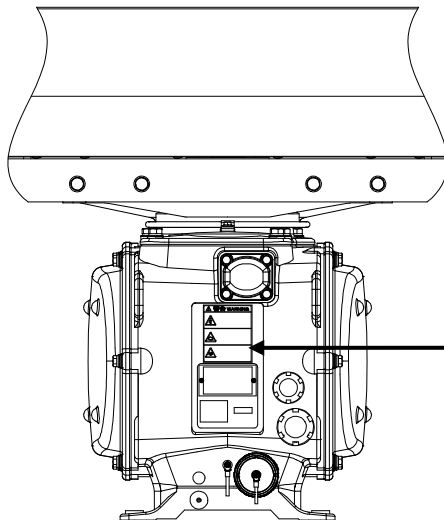

NKE-2632/A、NKE-2632-H Scanner Unit

Warning Label

| | |
|--|---|
| | 警告 WARNING |
| | このカバーをはずすな 感電の恐れあり HIGH VOLTAGE DO NOT REMOVE THE COVER |
| | 空中線の回転に注意 負傷の恐れあり SCANNER ROTATION DO NOT APPROACH |
| | 送信中は近づくな 電磁波被害の恐れあり RADIATION HAZARD DO NOT APPROACH |

Warning Label

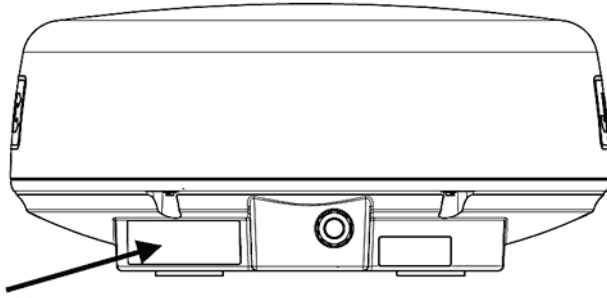

NKE-2043 Scanner Unit

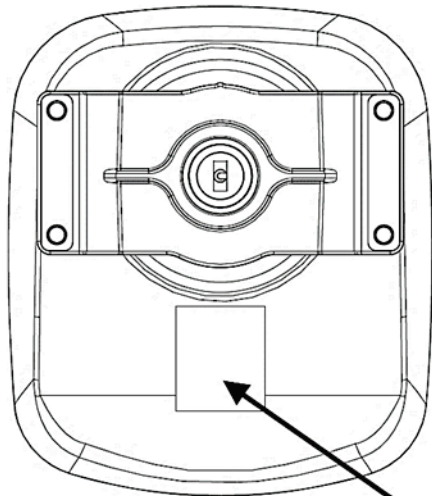

Warning Label



NKE-2063A SCANNER UNIT

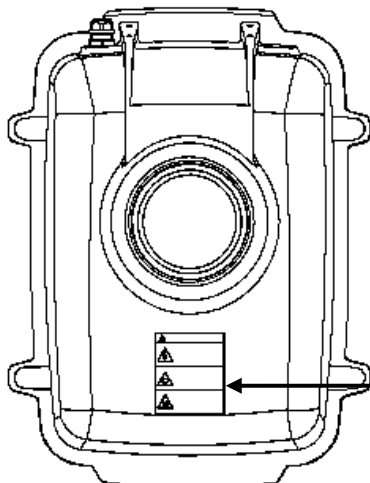

Warning Label



NKE-2103-4/4HS/6/6HS Scanner Unit

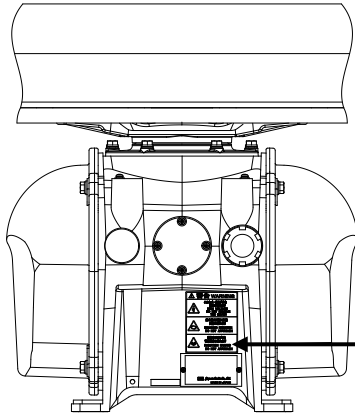

Warning Label

| | |
|---|---|
|  | 警告 WARNING |
|  | このカバーをはずすな 感電の恐れあり HIGH VOLTAGE DO NOT REMOVE THE COVER |
|  | 空中線の回転に注意 負傷の恐れあり SCANNER ROTATION DO NOT APPROACH |
|  | 送信中は近づくな 電磁波傷害の恐れあり RADIATION HAZARD DO NOT APPROACH |

NKE-2255-7/9/6HS Scanner Unit

EQUIPMENT APPEARANCE

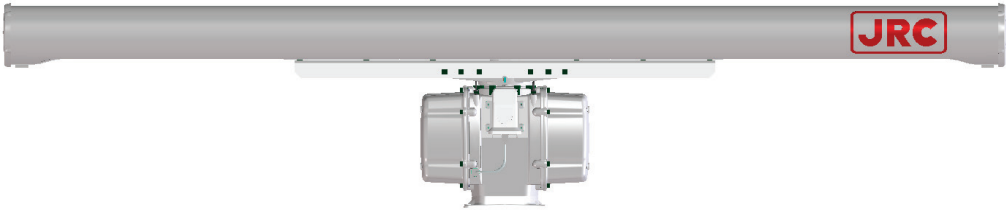

NKE-1130/A Scanner Unit

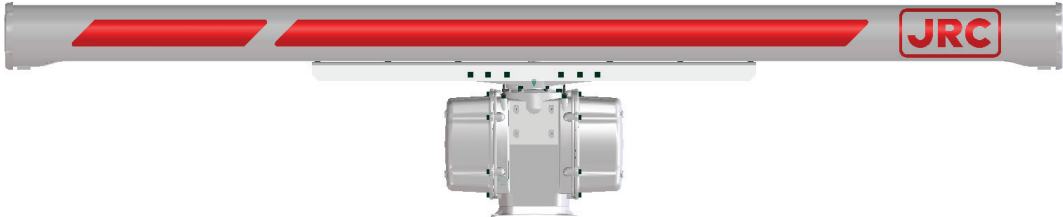

NKE-1632/A Scanner Unit

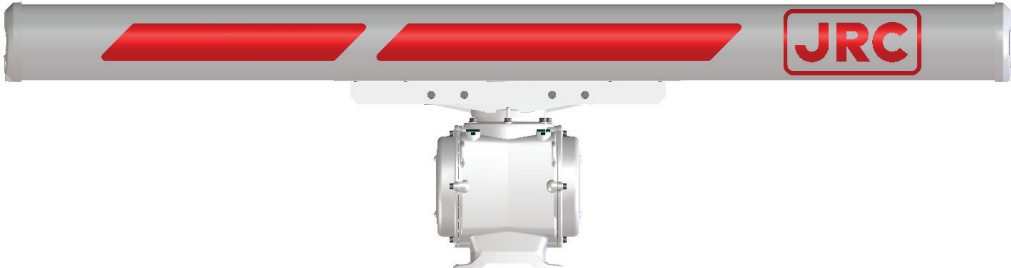

NKE-2632/A, NKE-2632-H Scanner Unit



NKE-2043 Scanner Unit



NKE-2063A Scanner Unit



NKE-2103-4/4HS Scanner Unit



NKE-2103-6/6HS Scanner Unit

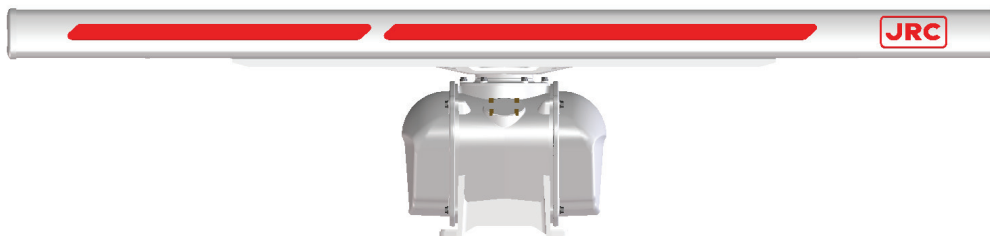

NKE-2255-7/9/6HS Scanner Unit



NCE-5794 Standard Operation Unit



NCE-5605 Trackball Operation Unit (Option) NCE-5625 Keyboard Operation Unit (Option)



NDC-1678/A Processing Unit



NWZ-214 19inch Display



NWZ-208 26inch Display

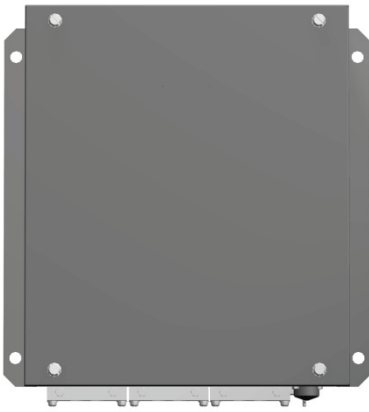

NQE-3167
Power Control Unit (Option)

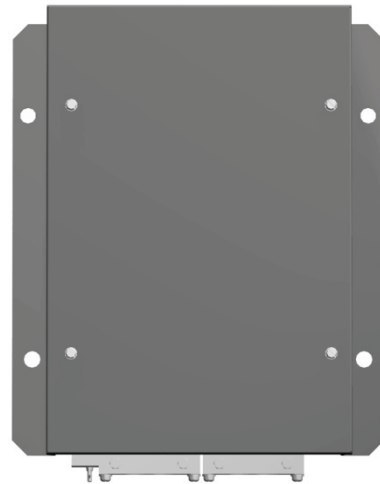

NQE-3141-4A
Interswitch Unit (Option)



NQE-3141-8A
Interswitch Unit (Option)

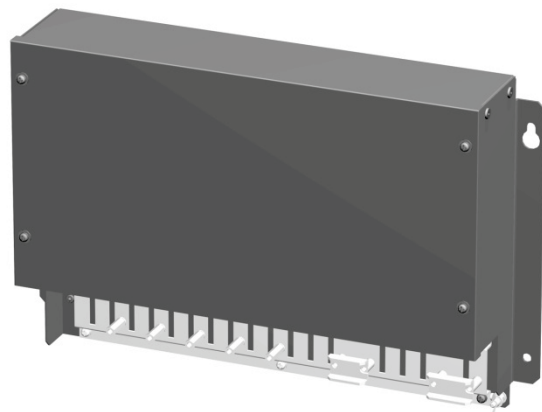

NQE-1143 Junction Box

Glossary

| | |
|-------------------|--|
| AIO | : Admiralty Information Overlay published by United Kingdom Hydrographic Office (UKHO). |
| AIS | : Automatic Identification System |
| AZ | : Acquisition/Activation zone |
| Anti-clutter rain | : Rain/snow clutter suppression |
| Anti-clutter sea | : Sea clutter suppression |
| AZI | : AZImuth stabilisation mode |
| BCR/BCT | : Bow Crossing Range/Bow Crossing Time |
| Chart Maintenance | : Software to manage the charts. Imports and updates the charts. |
| C-MAP MAX*1 | : Digital chart data by C-MAP |
| CTS | : Course To Steer. Heading command. |
| COG | : Course Over the Ground |
| C UP | : Course up. Own ship's course is pointed to the top centre of the radar display. |
| CCRP | : Consistent Common Reference Point. The own ship position, to which all horizontal measurements such as target range, bearing, relative course, relative speed, CPA or TCPA are referenced, typically the conning position of the bridge. |
| CORREL | : CORRELation |
| CPA/TCPA | : Distance to the Closest Point of Approach/Time to the Closest Point of Approach. |
| CTW | : Course Through Water. The direction of the ship's movement through the water |
| DIST | : Distance |
| DNV | : Det Norske Veritas |
| DRIFT | : The current velocity for manual correction or the current speed on the horizontal axis of the 2-axis log is displayed. |
| EBL | : Electronic Bearing Line |
| ETA | : Estimated Time of Arrival |
| ENH | : Enhance |
| GPS | : Global Positioning System |
| HDG | : Heading. Ship's heading |
| HL | : Heading Line |
| HSC | : High Speed Craft. Vessels which comply with the definition in SOLAS for high speed craft |
| H UP | : Head up. Own ship's heading line is always pointed to the top centre of the radar display. |
| IHO | : International Hydrographic Office |
| IMO | : International Maritime Organisation |
| IR | : Radar Interference Rejecter |
| ISW | : Interswitch Unit |
| LMT | : Local Mean Time |
| LON | : Longitude |
| LAT | : Latitude |

| | |
|-----------------|---|
| LP | : Long Pulse |
| MED | : Marine Equipment Directive. Request standard for standardisation of marine equipment within the EU region |
| MFD | : The formal name is Multi Function Display. The navigation support functions such as RADAR, ECDIS, CID, and AMS can be executed by switching. |
| MMSI | : Maritime Mobile Service Identity |
| MOB | : Man Over Board |
| MON | : Performance MONitor |
| MP | : Medium Pulse |
| newpec | : Electronic navigational chart by Japan Hydrographic Association |
| NM | : Nautical Mile 1 nm=1852 m |
| N UP | : The north is always pointed to the top centre of the radar display. (North up) |
| P0N | : Unmodulated pulse, which is a type of transmission radio wave. While it is a type of radio wave usually used by radars equipped with magnetrons, radio waves with a short pulse length are used also by solid-state radars for short-range detection. |
| PI | : Parallel Index line |
| Past Positions | : Equally time-spaced past position marks of a tracked or AIS target and the own ship. |
| POSN | : POSitioN |
| PRF | : Pulse Repetition Frequency. The number of radar pulses transmitted each second. |
| PROC | : PROCess. Radar signal processing function |
| Q0N | : A type of radio wave with intra-pulse frequency modulation. It is used for solid-state pulse compression radars. |
| RL | : Rhumb Line |
| RR | : Range Rings |
| Relative Vector | : A predicted movement of a target relative to own ship's motion |
| RM | : Relative Motion. A display on which the position of own ship remains fixed, and all targets move relative to own ship. |
| RM(R) | : Relative Motion. Relative Trails |
| RM(T) | : Relative Motion. True Trails |
| ROT | : Rate Of Turn. Change of heading per time unit |
| Route | : A set of waypoints |
| RPU | : RADAR Processing Unit |
| SOG | : Speed Over the Ground |
| SART | : Search And Rescue Transponder |
| SET | : The current direction for manual correction or the current speed on the horizontal axis of the 2-axis log is displayed. |
| SLC | : Serial LAN Interface Circuit |
| SP | : Short Pulse |
| STAB | : STABilisation |
| STW | : Speed Through Water |
| TCPA | : Time to Closest Point of Approach to own ship |

| | | |
|---------------------------|---|---|
| TM | : | True Motion. A display across which the own ship and targets move with their own true motions. |
| To WPT | : | To Waypoint (To WPT) |
| Trails | : | Tracks displayed by the radar echoes of targets in the form of an afterglow |
| Trial Manoeuvre | : | A graphical simulation facility used to assist the operator to perform a proposed manoeuvre for navigation and collision avoidance purposes |
| True Vector | : | A vector representing the predicted true motion of a target, as a result of input of the course and speed of the own ship |
| TT | : | Target Tracking |
| TTG | : | Time To Go. Time to next waypoint. |
| TXRX | : | Transceiver |
| UTC | : | Universal Time, Coordinated |
| VRM | : | Variable Range Marker |
| VDR | : | Voyage Data Recorder |
| WOL | : | Wheel Over Line |
| WPT | : | Waypoint |
| XTD | : | Cross Track Distance |
| XTL | : | Cross Track Limit |
| Activated Target | : | A target representing the automatic or manual activation of a sleeping AIS target for the display of additional information |
| Associated Target | : | A target simultaneously representing a tracked target and a AIS target which are decided as the same |
| Chirp | : | A type of transmission waveform with intra-pulse frequency modulation used by solid-state radars. Its radio wave type is classified as Q0N. |
| Clutter | : | Unwanted reflections on a radar screen, from sea surface, rain or snow. |
| Display | : | Screen displayed on the LCD |
| Frequency Deviation Range | : | The range of variation of the Q0N frequency used for transmission waves of a solid-state radar. Generally, the greater the frequency deviation range, the higher the resolution in the range direction. |
| Interswitch Unit | : | A device to switch over two or more radar display units and two or more radar antennas |
| Leg | : | Line between two consecutive waypoints |
| Lost AIS Target | : | A target symbol representing the last valid position of an AIS target before the reception of its data was lost, or its last dead-reckoned position. |
| Lost Tracked Target | : | One for which target information is no longer available due to poor, lost or obscured signals. |
| Power Amplifier | : | A radio frequency amplifier circuit consisting of semiconductor elements used for solid-state radars. It employs a high frequency, high power FET. |
| Primary | : | Main positioning sensor |

| | | |
|------------------------|---|---|
| Pulse Compression | : | Correlation processing performed when a transmitted chirp signal is received by a solid-state radar after reflecting off the target. This processing gain enables the radar to have necessary detection capability even when a transmission power is low. |
| Radar Beacon | : | A navigation aid which responds to the radar transmission and generates radio wave |
| Range | : | An area of the chart displayed on the screen. Represented by one half of the length of the chart display screen. |
| Range Side Lobe | : | False image that is generated as a result of pulse compression processing in the solid-state radar when there is a large target such as a large ship in the vicinity. |
| Reference Target | : | A fixed target specified to calculate the speed over the ground |
| Rubber Band | : | Border that indicates the selected range. |
| Scale | : | The display scale |
| Sea State | : | The average height of the wave expressed by dividing into several classes. |
| Sleeping AIS Target | : | A target indicating the presence and orientation of a vessel equipped with AIS |
| Spot Depth | : | Numeric representation of depth |
| SSR: Solid State Radar | : | Radar that uses semiconductor elements instead of magnetron, which requires periodic replacement. It is built with a system that ensures necessary detection capability even when a transmission output is low, by using chirp signals with a long pulse length upon transmission and performing pulse compression upon reception |

*1 © C-MAP 2017, All rights reserved.

Notations



Operation notations

Trackball operations on the operation panel are expressed as follows.

| Operation | Notation |
|-------------------------------|---|
| Click the left button. | Click Example: Click on the object. |
| Double-click the left button. | Double-click Example: Determine the drawing by double-click. |
| Click the right button | Click the right mouse button Example: Display the context menu by clicking the right mouse button. |

Button notations

The buttons and dialogue boxes on the screen are expressed as follows.

| Button type | Notation |
|--|---|
| Button with button name indicated | Example:  → [AUTO] (automatic) button |
| Button with an indication other than the button name such as an icon | Shown as follows. Example:  → Day/Night button |

Menu notations

A series menus are expressed as follows.

| Type | Notation |
|-------------------|---|
| Operation of menu | [Menu] button → User Map → File Operation |
| Position of menu | [User Map] – [File Operation] |

Contents

| | |
|---|------------|
| PREFACE | i |
| Pictorial Indication | x |
| Precautions upont Equipment Operation | xi |
| Section 1 Overview | 1-1 |
| 1.1 Functions | 1-2 |
| 1.2 Features..... | 1-3 |
| 1.3 Components..... | 1-6 |
| 1.4 Structure..... | 1-12 |
| 1.5 General System Diagrams | 1-36 |
| Section 2 Name and Function of Each Unit | 2-1 |
| 2.1 Name and Main Function of the Operation Unit | 2-1 |
| 2.1.1 Standard operation unit | 2-1 |
| 2.1.2 Display unit | 2-3 |
| 2.2 Names and Main Functions of the Mode Screen Common Sections | 2-4 |
| 2.2.1 [Menu] button | 2-4 |
| 2.2.2 Key assignment indication area | 2-5 |
| 2.2.3 Own ship information..... | 2-5 |
| 2.2.4 Other ship information | 2-8 |
| 2.2.5 Right toolbar..... | 2-9 |
| 2.2.6 Toolbar | 2-10 |
| 2.2.6.1 Buttons that are normally displayed | 2-11 |
| 2.2.6.2 Buttons that are normally hidden | 2-11 |
| 2.2.7 Alert notification area..... | 2-12 |
| 2.2.8 Other Common Area | 2-12 |
| 2.2.9 Navigation tools..... | 2-13 |
| 2.2.10 Range and mode information..... | 2-13 |
| 2.2.11 Radar signal information..... | 2-14 |
| 2.2.12 Radar system information..... | 2-15 |
| 2.2.13 Display inside the PPI..... | 2-16 |
| 2.3 Common Information Window | 2-17 |
| 2.3.1 Information monitor windows | 2-18 |
| 2.3.1.1 Target INFO | 2-18 |
| 2.3.1.2 TT List..... | 2-20 |
| 2.3.1.3 AIS List | 2-20 |
| 2.3.1.4 AIS Detail INFO..... | 2-20 |
| 2.3.1.5 2nd PPI..... | 2-23 |

| | | |
|------------------|--|------------|
| 2.3.1.6 | Wind/Current Block | 2-23 |
| 2.3.1.7 | Conning | 2-24 |
| 2.3.2 | Information reference windows | 2-25 |
| 2.3.2.1 | Switching between a standard window and an extended window | 2-25 |
| 2.3.2.2 | AIS MSG Tray | 2-25 |
| 2.3.2.3 | NAVTEX..... | 2-26 |
| 2.3.2.4 | Active Alert..... | 2-28 |
| 2.3.2.5 | Alert History | 2-28 |
| 2.3.2.6 | Maintenance INFO..... | 2-28 |
| 2.3.2.7 | AIS..... | 2-29 |
| Section 3 | Common Basic Operations | 3-1 |
| 3.1 | Powering On and Starting | 3-1 |
| 3.2 | Starting Each Mode..... | 3-1 |
| 3.3 | Basic Operations When Using a Trackball | 3-2 |
| 3.3.1 | Basic trackball operations..... | 3-2 |
| 3.3.2 | Basic operations of clicking, right-clicking and double-clicking | 3-2 |
| 3.3.3 | Displaying simplified information and operational guide of objects..... | 3-3 |
| 3.3.4 | Cursor types..... | 3-3 |
| 3.4 | Basic Menu Operations | 3-5 |
| 3.4.1 | Opening the menu..... | 3-5 |
| 3.4.2 | Menu list | 3-6 |
| 3.4.3 | Closing the menu | 3-6 |
| 3.5 | Basic Dialogue Box Operations | 3-7 |
| 3.5.1 | Changing dialogue box settings..... | 3-7 |
| 3.5.2 | Closing a dialogue box | 3-9 |
| 3.5.3 | Title Bar | 3-10 |
| 3.6 | Operation of the Information Monitor Window | 3-11 |
| 3.6.1 | Opening the information monitor window | 3-11 |
| 3.6.2 | Displaying an information monitor window from other than the [Page Selection] dialogue box..... | 3-11 |
| 3.7 | Confirming and Acknowledging an Alert..... | 3-12 |
| 3.7.1 | Stopping a buzzer | 3-13 |
| 3.7.2 | Confirming alert contents..... | 3-13 |
| 3.7.3 | Acknowledging the alert | 3-14 |
| 3.7.4 | Displaying active alert and alert history..... | 3-14 |
| 3.8 | Switching the Day/Night Mode..... | 3-16 |
| 3.9 | Adjusting the Brightness of the Screen and Operation Unit | 3-17 |
| 3.9.1 | [Display Brightness] dialogue..... | 3-17 |
| 3.10 | Switching the Mode | 3-18 |
| 3.10.1 | Function restriction by mode..... | 3-18 |
| 3.11 | Mouseover Display..... | 3-19 |

| | | |
|-----------|---|------|
| 3.11.1 | Condition and timing of mouseover display | 3-19 |
| 3.11.1.1 | Starting mouseover display | 3-19 |
| 3.11.1.2 | Terminating mouseover display | 3-19 |
| 3.11.2 | How to read mouseover display..... | 3-20 |
| 3.12 | MOB (Man Over Board)..... | 3-21 |
| 3.13 | Electronic Bearing Line (EBL) and Variable Range Marker (VRM) | 3-22 |
| 3.13.1 | Electronic Bearing Line (EBL) and Variable range marker (VRM)..... | 3-22 |
| 3.13.2 | Displaying the EBL and VRM buttons | 3-23 |
| 3.13.3 | Basic manipulation of EBL/VRM | 3-23 |
| 3.13.3.1 | Switching the control right of EBL/VRM | 3-23 |
| 3.13.3.2 | Setting up the measurement starting points..... | 3-24 |
| 3.13.3.3 | Setting the EBL bearing to True/Relative display..... | 3-24 |
| 3.13.3.4 | Setting up the range unit of VRM..... | 3-25 |
| 3.13.3.5 | Operating the intersecting point between EBL and VRM..... | 3-25 |
| 3.14 | Rectangle Cursor | 3-26 |
| 3.15 | Cursor AUTO Mode..... | 3-28 |
| 3.15.1 | No object..... | 3-28 |
| 3.15.2 | AIS..... | 3-29 |
| 3.15.3 | TT..... | 3-30 |
| 3.15.4 | (AZ) Acquisition/Activation Zone | 3-30 |
| 3.15.5 | AIS filter | 3-32 |
| 3.15.6 | User map | 3-32 |
| 3.15.6.1 | Non-selected object..... | 3-32 |
| 3.15.6.2 | Selected object | 3-33 |
| 3.15.7 | EBL..... | 3-34 |
| 3.15.8 | VRM..... | 3-34 |
| 3.15.9 | EBL/VRM intersecting point..... | 3-34 |
| 3.15.10 | PI..... | 3-34 |
| 3.15.11 | Monitoring dragging anchor | 3-35 |
| 3.15.11.1 | Object in the unselected state..... | 3-35 |
| 3.15.11.2 | Selected state | 3-35 |
| 3.16 | Saving the Screen That Is Currently Displayed | 3-36 |
| 3.17 | “Favourite” Registering Function..... | 3-37 |
| 3.17.1 | Registering/cancelling favourites | 3-37 |
| 3.17.2 | Calling a favourite..... | 3-37 |
| 3.18 | [MULTI] Dial | 3-38 |
| 3.18.1 | Functions of [MULTI] dial..... | 3-38 |
| 3.18.2 | Functions assigned to [MULTI] dial | 3-38 |
| 3.18.2.1 | Displaying a screen for setting the function that is assigned..... | 3-38 |
| 3.18.2.2 | Changing the function that is assigned | 3-38 |
| 3.19 | Basic Operations of the Software Keyboard..... | 3-39 |
| 3.19.1 | Starting a software keyboard | 3-39 |

| | | |
|------------------|--|------------|
| 3.19.2 | Name and function of each section of the keyboard | 3-39 |
| 3.20 | Setting a Date and a Time (Calendar Operation) | 3-42 |
| 3.20.1 | Details and usage of a calendar picker and a time picker | 3-42 |
| 3.20.1.1 | Details of a calendar | 3-42 |
| 3.21 | Help | 3-43 |
| 3.22 | Password Input | 3-44 |
| 3.23 | Managing Files with File Manager | 3-45 |
| 3.23.1 | File management | 3-45 |
| 3.23.1.1 | Copying a file | 3-46 |
| 3.23.1.2 | Deleting a file | 3-46 |
| 3.23.2 | Loading and saving files | 3-47 |
| 3.23.2.1 | Loading files | 3-48 |
| 3.23.2.2 | Unloading data (clearing data from the data screen) | 3-48 |
| 3.23.2.3 | Saving files | 3-48 |
| 3.24 | Using a Key Macro | 3-49 |
| 3.24.1 | Recording a key macro | 3-49 |
| 3.25 | Operate remotely the Marine VHF Radiotelephone (JHS-800S) | 3-50 |
| 3.25.1 | Select VHF Radiotelephone (JHS-800S) for use | 3-50 |
| 3.25.2 | Display VHF Radiotelephone status from menu-bar | 3-52 |
| 3.25.3 | DSC call for AIS target on RADAR PPI | 3-55 |
| 3.26 | Returning to the Mode Selection Screen by Terminating Operation | 3-57 |
| 3.27 | Terminating This Equipment | 3-57 |
| Section 4 | Range and Bearing Measurement Methods | 4-1 |
| 4.1 | List of Measuring Tools | 4-1 |
| 4.2 | Target Position | 4-2 |
| 4.3 | Using the Cross-hair Cursor | 4-3 |
| 4.3.1 | Displaying information in the cursor information readout area | 4-3 |
| 4.3.2 | Measuring the bearing and the range from the own ship's position to the target by using the cross-hair cursor | 4-4 |
| 4.3.2.1 | Measuring by using the cursor information that is displayed by placing the cursor inside of PPI | 4-5 |
| 4.3.2.2 | Setting a reference point | 4-6 |
| 4.4 | Using the Range Rings | 4-7 |
| 4.5 | Using the Electronic Bearing Line (EBL) and Variable Range Marker (VRM) | 4-8 |
| 4.5.1 | Measuring a range and a bearing with EBL and VRM | 4-8 |
| 4.5.1.1 | Measuring a range and a bearing with the trackball section of the operation unit | 4-8 |
| 4.5.1.2 | Measuring with the [EBL] or [VRM] dial on the keyboard operation unit | 4-9 |
| 4.5.2 | Measuring between arbitrary two points | 4-11 |
| 4.6 | Using Parallel Index Lines (PI) | 4-13 |
| 4.6.1 | Description of a parallel index line | 4-13 |

| | | |
|------------------|--|------------|
| 4.6.2 | Displaying parallel index lines..... | 4-13 |
| 4.6.2.1 | Displaying parallel index lines by using the [PI] button on the screen | 4-13 |
| 4.6.2.2 | Displaying parallel index lines by using the [PI] key on the operation unit..... | 4-14 |
| 4.6.2.3 | Description of the [PI Menu] dialogue | 4-14 |
| 4.6.3 | Setting all the parallel index lines concurrently (All mode)..... | 4-16 |
| 4.6.3.1 | Changing the bearing/interval of parallel index lines in the operation unit (All mode) | 4-17 |
| 4.6.4 | Setting parallel index lines individually (Individual mode) | 4-18 |
| 4.6.4.1 | Changing the bearing/interval/end point of parallel index lines in the trackball operation unit (Individual mode)..... | 4-20 |
| 4.6.5 | Displaying lines at equal interval on the left and right sides of the own ship's position (Track mode)..... | 4-21 |
| 4.6.5.1 | Changing the bearing/interval of parallel index lines with the trackball (Track mode) | 4-22 |
| 4.6.6 | Displaying two intersecting lines (Equiangular mode)..... | 4-23 |
| 4.6.6.1 | Changing the bearing of two intersecting lines in the trackball (Equiangular mode) | 4-24 |
| 4.6.7 | Setting parallel index lines in the operation unit | 4-25 |
| 4.6.7.1 | Operation in [All] mode..... | 4-25 |
| 4.6.7.2 | Operation in [Individual] mode | 4-26 |
| 4.6.7.3 | Operation in [Track] mode | 4-26 |
| 4.6.7.4 | Operation in [Equiangular] mode | 4-27 |
| 4.7 | Using the EBL Manoeuvre..... | 4-28 |
| 4.7.1 | Setting the creation conditions of the EBL Manoeuvre | 4-28 |
| 4.7.2 | Creating an EBL manoeuvre curve | 4-29 |
| 4.8 | Offsetting the Own Ship's Position Manually (Position Offset Function of Manual position fix)..... | 4-30 |
| 4.8.1 | [Position Offset] tab of the [Manual position fix] dialogue box | 4-30 |
| 4.8.2 | Setting the offset amount that is input in the [Enter Offset] dialogue as the offset position | 4-31 |
| 4.8.3 | Setting the position on the chart on which the mouse button was clicked as the offset position | 4-31 |
| Section 5 | Basic Operation of the Radar..... | 5-1 |
| 5.1 | Overview Flowchart..... | 5-1 |
| 5.2 | Starting and Shutting Down the Radar..... | 5-2 |
| 5.2.1 | Powering on and starting..... | 5-2 |
| 5.2.2 | Exiting radar operation | 5-3 |
| 5.3 | Observation Environment and Image Adjustment..... | 5-4 |
| 5.3.1 | Adjusting screen brightness..... | 5-4 |
| 5.3.2 | Changing the observation range..... | 5-4 |
| 5.3.3 | Adjusting tune | 5-5 |
| 5.3.4 | Adjusting gain | 5-6 |

| | | |
|------------------|---|------------|
| 5.3.5 | Rejecting sea clutter (Sea) | 5-7 |
| 5.3.6 | Rejecting rain/snow clutter | 5-9 |
| 5.3.7 | Adjusting to optimal images (Selection of observation scenes) | 5-11 |
| 5.4 | General Radar Operation | 5-13 |
| 5.4.1 | Interference Rejection (IR function) | 5-13 |
| 5.4.2 | Changing the transmitter pulse length | 5-14 |
| 5.4.3 | Enhancing targets | 5-15 |
| 5.4.4 | Using video processing (Echo Process) | 5-16 |
| 5.4.5 | Setting the azimuth mode | 5-17 |
| 5.4.6 | Setting a motion mode | 5-19 |
| 5.4.6.1 | Resetting own ship to its initial position in [TM] (True Motion display) mode | 5-20 |
| 5.4.7 | Setting the stabilisation mode | 5-21 |
| 5.4.8 | Moving own ship's display position (Off Centre) | 5-21 |
| 5.4.9 | Displaying other ship's trails (Trails) | 5-23 |
| 5.4.9.1 | Trails motion mode | 5-23 |
| 5.4.9.2 | Changing motion mode of trails | 5-24 |
| 5.4.9.3 | Setting the length of the trail | 5-24 |
| 5.4.9.4 | Clearing trails data | 5-25 |
| 5.4.10 | Doubling the size of radar image | 5-26 |
| 5.4.11 | Hiding the heading line (HL OFF) | 5-27 |
| 5.4.12 | Hiding graphics information on radar display | 5-28 |
| 5.4.13 | Setting true bearing | 5-28 |
| 5.4.14 | Setting own ship speed | 5-29 |
| 5.4.14.1 | Switching own ship speed device | 5-29 |
| 5.4.14.2 | Entering the ship's heading/own ship's speed manually | 5-29 |
| Section 6 | Target Tracking and AIS | 6-1 |
| 6.1 | Restrictions | 6-2 |
| 6.2 | Collision Avoidance Issue (Explanation) | 6-3 |
| 6.2.1 | Collision avoidance in navigation | 6-3 |
| 6.2.2 | Marine accidents and collisions | 6-3 |
| 6.2.3 | Basic concept of collision avoidance | 6-4 |
| 6.2.4 | Relative vector and true vector | 6-5 |
| 6.2.5 | Radar and collision avoidance | 6-5 |
| 6.3 | Displaying Symbols | 6-6 |
| 6.3.1 | Displaying/hiding target tracking symbols/AIS target symbols | 6-6 |
| 6.3.2 | Types and definitions of target tracking symbols | 6-6 |
| 6.3.3 | Types and definitions of AIS target symbols | 6-7 |
| 6.3.4 | About AIS AtoN (Aids to Navigation) | 6-13 |
| 6.3.5 | About AIS-SART Information | 6-13 |
| 6.3.6 | About display priority of AIS targets | 6-14 |
| 6.3.7 | Switching between ground vector and water vector | 6-15 |
| 6.3.8 | Association target symbols | 6-15 |

| | | |
|---------|---|------|
| 6.4 | Preparation | 6-16 |
| 6.4.1 | Setting the cursor mode to AUTO mode..... | 6-16 |
| 6.4.2 | Setting vector | 6-16 |
| 6.4.2.1 | Vector modes | 6-16 |
| 6.4.2.2 | Setting vector mode | 6-17 |
| 6.4.2.3 | Vector length (Vector time) | 6-18 |
| 6.4.2.4 | Setting the vector length..... | 6-18 |
| 6.4.3 | Setting collision decision criteria | 6-18 |
| 6.4.3.1 | Setting CPA limit..... | 6-19 |
| 6.4.3.2 | Setting TCPA limit..... | 6-19 |
| 6.4.4 | Showing the CPA ring..... | 6-19 |
| 6.5 | Setting and operating target tracking | 6-20 |
| 6.5.1 | Acquiring target | 6-20 |
| 6.5.1.1 | Automatic acquisition (automatic acquisition) mode | 6-20 |
| 6.5.1.2 | ACQ manual (manual acquisition) mode..... | 6-21 |
| 6.5.1.3 | Using manual acquisition and AUTO acquisition together | 6-21 |
| 6.5.2 | Setting up the automatic acquisition/ activation zone (AZ)..... | 6-22 |
| 6.5.2.1 | Using [New Target Warning] dialogue box in the [Alert] menu | 6-22 |
| 6.5.2.2 | Using the cursor | 6-23 |
| 6.5.2.3 | Using the EBL/VRM dial for the setting..... | 6-23 |
| 6.5.3 | Tracked target information display | 6-24 |
| 6.5.4 | Erasing unwanted tracked targets..... | 6-25 |
| 6.5.5 | Displaying target ID No..... | 6-26 |
| 6.5.6 | Editing tracked target properties | 6-26 |
| 6.5.6.1 | Adding tracked target ID name | 6-27 |
| 6.5.6.2 | Setting track colour of tracked target | 6-27 |
| 6.5.7 | Setting target for which ground is fixed to a reference target..... | 6-28 |
| 6.5.8 | Operation test for target tracking..... | 6-29 |
| 6.5.8.1 | [Test Video] | 6-30 |
| 6.5.8.2 | [TT Simulator] (Target tracking simulator) | 6-31 |
| 6.5.8.3 | [Gate Display] | 6-32 |
| 6.5.8.4 | [Status] display..... | 6-32 |
| 6.6 | Setting and operating AIS..... | 6-33 |
| 6.6.1 | Enabling AIS function | 6-33 |
| 6.6.2 | Activating AIS targets (Activate AIS) | 6-33 |
| 6.6.2.1 | Manual activation | 6-33 |
| 6.6.2.2 | Automatic activation | 6-34 |
| 6.6.3 | Deactivating AIS targets | 6-34 |
| 6.6.4 | Displaying AIS information..... | 6-35 |
| 6.6.5 | Displaying Target ID No..... | 6-39 |
| 6.6.6 | Checking and setting AIS target property..... | 6-39 |
| 6.6.6.1 | Setting track colour of AIS target | 6-39 |
| 6.6.7 | Conditions for deciding AIS target to be lost..... | 6-40 |

| | | |
|------------------|---|------------|
| 6.7 | Alert Display..... | 6-41 |
| 6.7.1 | Danger target alarm (CPA/TCPA)..... | 6-42 |
| 6.7.2 | Warning for new target acquired in automatic acquisition guard zone (New target) | 6-43 |
| 6.7.3 | Lost target warning (Lost)..... | 6-44 |
| 6.7.4 | Target Tracking function alarm (TT Data)..... | 6-45 |
| 6.7.5 | Gyro set notification (Set Gyro)..... | 6-45 |
| 6.8 | Track Function | 6-46 |
| 6.8.1 | Setting the past position | 6-46 |
| 6.8.2 | Setting the other ship's tracks..... | 6-47 |
| 6.8.2.1 | Setting track colour | 6-47 |
| 6.8.2.2 | Turning on/off other ship's track function..... | 6-47 |
| 6.8.2.3 | Setting other ship's track colours | 6-47 |
| 6.8.2.4 | Turning on/off other ship's track display | 6-47 |
| 6.8.2.5 | Setting up the display interval of other ship's track..... | 6-47 |
| 6.8.2.6 | Clearing other ship's track | 6-47 |
| 6.8.2.7 | Saving and loading other ship's track data..... | 6-47 |
| 6.9 | Entering Own Ship's AIS Voyage Data..... | 6-48 |
| 6.10 | Editing and Sending AIS Messages | 6-49 |
| 6.11 | AIS Message Tray..... | 6-51 |
| 6.11.1 | Displaying the AIS message tray | 6-51 |
| 6.11.2 | Switching message display..... | 6-52 |
| 6.11.3 | Sending a message in the message tray after editing | 6-53 |
| 6.12 | Highlighting TT/AIS Symbols | 6-54 |
| 6.12.1 | Highlighting TT/AIS Symbols by specifying search criteria | 6-54 |
| 6.12.2 | Highlighting AIS Symbols by list..... | 6-55 |
| 6.13 | Trial Manoeuvring..... | 6-56 |
| 6.13.1 | Outline of trial manoeuvring..... | 6-56 |
| 6.13.2 | Performing a trial manoeuvre..... | 6-58 |
| 6.14 | Displaying the TT/AIS Target List..... | 6-59 |
| 6.14.1 | TT list..... | 6-59 |
| 6.14.2 | AIS list | 6-60 |
| 6.15 | Confirming Own Ship's AIS Information | 6-62 |
| 6.16 | Displaying the Last Lost AIS Target | 6-63 |
| Section 7 | True and False Echoes on Display | 7-1 |
| 7.1 | Radar Wave with the Horizon..... | 7-1 |
| 7.2 | Intensity Reflected from the Target | 7-3 |
| 7.3 | Sea Clutter and Rain/Snow Clutter | 7-4 |
| 7.3.1 | Sea clutter..... | 7-4 |
| 7.3.2 | Rain and snow clutter | 7-5 |
| 7.3.3 | Coping with sea clutter and rain/snow clutter | 7-6 |

| | | |
|------------------|---|------------|
| 7.4 | False Echoes | 7-7 |
| 7.4.1 | Shadow..... | 7-7 |
| 7.4.2 | Side lobe effect | 7-7 |
| 7.4.3 | False echo by secondary reflection..... | 7-8 |
| 7.4.4 | False echo by multiple reflection..... | 7-8 |
| 7.4.5 | Second time echoes..... | 7-9 |
| 7.4.6 | Radar interference..... | 7-9 |
| 7.5 | Radar Transponder (SART) Screen Display..... | 7-10 |
| 7.6 | Display of AIS-SART | 7-12 |
| 7.6.1 | Radar screen display example..... | 7-12 |
| 7.6.2 | Numeric data display example..... | 7-12 |
| Section 8 | Monitoring a Dragging Anchor | 8-1 |
| 8.1 | Setting a Dragging Anchor Monitoring Area | 8-2 |
| 8.1.1 | Setting a dragging anchor monitoring circle | 8-2 |
| 8.1.2 | Setting a dragging anchor monitoring polygon | 8-2 |
| 8.2 | Starting and Ending Dragging Anchor Monitoring..... | 8-3 |
| 8.2.1 | Starting dragging anchor monitoring | 8-3 |
| 8.2.2 | Ending dragging anchor monitoring | 8-3 |
| 8.3 | Moving/Editing/Deleting a Dragging Anchor Monitoring Area on the Chart..... | 8-4 |
| 8.3.1 | Moving a dragging anchor monitoring circle on the chart..... | 8-4 |
| 8.3.2 | Moving a dragging anchor monitoring circle on the context menu..... | 8-4 |
| 8.3.3 | Moving a dragging anchor monitoring polygon on the chart..... | 8-4 |
| 8.3.4 | Moving a dragging anchor monitoring ploygon on the context menu | 8-5 |
| 8.3.5 | Changing a size of a dragging anchor monitoring circle on the chart..... | 8-5 |
| 8.3.6 | Changing a size of a dragging anchor monitoring circle on the context menu..... | 8-5 |
| 8.3.7 | Changing a shape of a dragging anchor monitoring polygon on the chart..... | 8-6 |
| 8.3.8 | Changing a shape of a dragging anchor monitoring polygon on the context menu..... | 8-6 |
| Section 9 | Chart | 9-1 |
| 9.1 | Common | 9-1 |
| 9.1.1 | Special Line..... | 9-1 |
| 9.1.1.1 | Managing special line data..... | 9-1 |
| 9.2 | C-MAP MAX..... | 9-2 |
| 9.2.1 | Warning screen | 9-2 |
| 9.2.2 | C-MAP cartridge information..... | 9-3 |
| 9.2.2.1 | Contents of C-MAP cartridge information | 9-3 |
| 9.2.2.2 | Cartridge code..... | 9-3 |
| 9.2.2.3 | Area code | 9-4 |
| 9.2.3 | Searching for a port or service | 9-5 |
| 9.2.4 | Pick report (C-MAP MAX)..... | 9-6 |
| 9.3 | newpec | 9-7 |
| 9.3.1 | Warning screen | 9-7 |

| | | |
|-------------------|---|-------------|
| 9.3.2 | Managing the newpec chart..... | 9-8 |
| 9.3.3 | Pick report (newpec)..... | 9-8 |
| Section 10 | Creating a User Map | 10-1 |
| 10.1 | Display the "User Map" menu..... | 10-2 |
| 10.2 | Creating/Editing a User Map..... | 10-3 |
| 10.2.1 | Displaying the File Operation dialogue..... | 10-4 |
| 10.2.1.1 | [File Operation] dialogue | 10-4 |
| 10.2.2 | Creating a new user map..... | 10-5 |
| 10.2.3 | Editing the existing user map..... | 10-5 |
| 10.2.3.1 | Editing the user map that is currently displayed | 10-5 |
| 10.2.4 | Displaying a user map | 10-5 |
| 10.2.5 | Operating a user map file | 10-6 |
| 10.2.5.1 | Deleting a user map file..... | 10-6 |
| 10.2.5.2 | Copying a user map file..... | 10-6 |
| 10.2.5.3 | Merging multiple user map files | 10-6 |
| 10.3 | Managing/Editing an Object [Mark/Line List]..... | 10-7 |
| 10.3.1 | Displaying a user map list..... | 10-7 |
| 10.3.1.1 | Copying an object | 10-7 |
| 10.3.1.2 | Deleting an object | 10-7 |
| 10.4 | Bulk Deletion of Objects [Delete by Type/Colour]..... | 10-8 |
| 10.5 | Using Map Creation Tools..... | 10-9 |
| 10.5.1 | User map information bar | 10-9 |
| 10.5.2 | Drawing toolbar | 10-9 |
| 10.5.3 | Selecting an object type | 10-10 |
| 10.5.4 | Selecting a colour of an object..... | 10-10 |
| 10.5.5 | Creating an object in the EBL/VRM mode..... | 10-11 |
| 10.5.6 | Creating an object by specifying latitude and longitude | 10-11 |
| 10.5.6.1 | Creating an object of Mark/Text..... | 10-11 |
| 10.5.6.2 | Creating an object of Line..... | 10-11 |
| 10.5.7 | Deleting an object | 10-12 |
| 10.5.8 | Object property dialogue | 10-12 |
| 10.5.8.1 | Selecting an object..... | 10-12 |
| 10.5.8.2 | Setting a comment | 10-12 |
| 10.5.9 | Changing an object display scale range..... | 10-13 |
| 10.5.10 | Moving an object..... | 10-13 |
| 10.6 | Creating an Object | 10-14 |
| 10.6.1 | Creating a mark (Mark object) | 10-15 |
| 10.6.1.1 | Creating an object by specifying the latitude and longitude | 10-15 |
| 10.6.1.2 | Creating an object with EBL/VRM operation | 10-16 |
| 10.6.2 | Creating a line (Line object)..... | 10-17 |
| 10.6.2.1 | Creating a vertex by entering the position..... | 10-18 |
| 10.6.2.2 | Creating an object with EBL/VRM operation | 10-19 |

| | | |
|-------------------|--|-------------|
| 10.6.3 | Creating a text (Text object)..... | 10-20 |
| 10.6.3.1 | Creating a text by specifying the latitude and longitude..... | 10-20 |
| 10.6.3.2 | Creating a text with EBL/VRM operation..... | 10-21 |
| 10.6.3.3 | Editing a text..... | 10-21 |
| 10.6.3.4 | Editing a template..... | 10-22 |
| 10.6.3.5 | Changing a text angle..... | 10-22 |
| Section 11 | Setting up Screen View | 11-1 |
| 11.1 | Setting Screen Display Options..... | 11-1 |
| 11.1.1 | Setting up the display of own ship symbol..... | 11-2 |
| 11.1.2 | Setting up the display of own ship's tracks..... | 11-4 |
| 11.1.3 | Setting up the display of the past position..... | 11-5 |
| 11.1.4 | Setting up the display of user map..... | 11-5 |
| 11.1.5 | Setting up transparency of echo/radar trails..... | 11-6 |
| 11.1.6 | Setting up the display of TT/AIS target..... | 11-6 |
| 11.1.7 | Setting up the display of other ship's track..... | 11-8 |
| 11.1.8 | Setting a chart..... | 11-9 |
| 11.1.9 | Setting up the display of C-MAP MAX..... | 11-10 |
| 11.1.10 | Setting up the display of newpec..... | 11-13 |
| 11.1.11 | Setting up the display of range/bearing measurement function..... | 11-16 |
| 11.1.12 | Setting up the display of unit of setting value..... | 11-17 |
| 11.1.13 | Setting control of the top screen and menus..... | 11-17 |
| 11.1.14 | Setting up the display of depth graph..... | 11-19 |
| 11.1.15 | Setting up the display of water temperature graph..... | 11-19 |
| Section 12 | Setting up Alerts | 12-1 |
| 12.1 | Selecting Setting Items..... | 12-1 |
| 12.2 | Collision Avoidance Alert Generation Conditions..... | 12-2 |
| 12.2.1 | Setting the CPA/TCPA limit values..... | 12-2 |
| 12.2.2 | Setting the status of the AIS/TT target that is targeted for lost warning..... | 12-2 |
| 12.3 | New Target Warning Generation Conditions..... | 12-3 |
| 12.3.1 | Switching AZ1/AZ2 to enable/disable..... | 12-3 |
| 12.3.1.1 | Enabling AZ1 or AZ2..... | 12-3 |
| 12.3.1.2 | Disabling AZ1 or AZ2..... | 12-3 |
| 12.4 | Depth Alert Issuing Conditions..... | 12-4 |
| 12.5 | RADAR Alarm Issuing Conditions..... | 12-5 |
| 12.6 | Position Integrity Alert Generation Conditions..... | 12-7 |
| 12.6.1 | Setting up the generation condition of the Position monitor..... | 12-7 |
| 12.6.2 | Setting up the HDOP exceeded generation condition..... | 12-7 |
| 12.7 | Setting up Alert Processing..... | 12-8 |
| Section 13 | Setting up the Operation Mode..... | 13-1 |
| 13.1 | Basic Operation of the [Settings] Dialogue..... | 13-1 |

| | | |
|---|---|-------------|
| 13.2 | Setting Radar Signal Processing | 13-2 |
| 13.3 | Presetting Each Observation Scene | 13-3 |
| 13.4 | Observation Scene Common Settings | 13-8 |
| 13.5 | Setting Other Ship's Radar Trails..... | 13-9 |
| 13.6 | Setting Radar Trail Mask | 13-10 |
| 13.7 | Setting Radar Antennas..... | 13-12 |
| 13.8 | Setting Associations | 13-13 |
| 13.9 | Setting Own Ship's Dynamic Trait..... | 13-14 |
| 13.10 | Setting Consort Ship Preset | 13-15 |
| 13.11 | Setting Operation Tests | 13-16 |
| 13.12 | Setting AIS Filters..... | 13-17 |
| 13.13 | Setting the Target Track Function to ON/OFF | 13-19 |
| 13.14 | Setting NAVTEX..... | 13-20 |
| 13.15 | Setting an Event Mark..... | 13-22 |
| 13.16 | Setting Datum Conversion..... | 13-23 |
| 13.17 | Setting Navigation Equipment | 13-24 |
| 13.18 | Setting GPS | 13-25 |
| 13.19 | Setting DGPS..... | 13-27 |
| 13.20 | Setting SBAS | 13-28 |
| 13.21 | Setting Cursor, EBL/VRM | 13-29 |
| 13.22 | Setting Colours and Brightness | 13-30 |
| 13.23 | Setting Sounds..... | 13-33 |
| 13.24 | Setting Key Assignment..... | 13-35 |
| 13.25 | Setting Preferences Information | 13-38 |
| 13.26 | Setting Screen Capture | 13-44 |
| Section 14 Adjusting and Setting up Equipment (for Services) | | 14-1 |
| 14.1 | Service Menu | 14-1 |
| 14.2 | Radar Adjustment..... | 14-2 |
| 14.2.1 | Performing basic adjustments on the radar..... | 14-2 |
| 14.2.1.1 | Tune adjustment | 14-2 |
| 14.2.1.2 | Automating coarse tuning adjustment..... | 14-2 |
| 14.2.1.3 | Adjusting the bearing..... | 14-3 |
| 14.2.1.4 | Adjusting a distance | 14-3 |
| 14.2.1.5 | Radar operation modes | 14-3 |
| 14.2.2 | Adjusting radar antenna | 14-4 |
| 14.2.2.1 | Adjusting an radar antenna height | 14-4 |
| 14.2.2.2 | Setting a tuning bar peak value | 14-4 |
| 14.2.2.3 | Adjusting a tuning peak value | 14-5 |
| 14.2.2.4 | Setting bearing pulse output | 14-5 |
| 14.2.3 | Adjusting a radar performance monitor | 14-6 |

| | | |
|-------------------|--|-------------|
| 14.2.3.1 | Displaying the [Performance Monitor]/[Performance Monitor (SSR)] dialogue | 14-6 |
| 14.2.3.2 | Adjusting a performance monitor of magnetron radars (NKE-2103 , NKE-1130/A) | 14-7 |
| 14.2.3.3 | Adjusting a performance monitor of a magnetron radar (NKE-2255) | 14-8 |
| 14.2.3.4 | Adjusting a performance monitor of a Solid State Radar (NKE-1632/A, NKE-2632/A, NKE-2632-H) | 14-9 |
| 14.2.4 | Setting sector blank | 14-10 |
| 14.2.4.1 | Setting sector blank | 14-10 |
| 14.2.5 | Adjusting the TT function | 14-11 |
| 14.2.5.1 | Setting vector constants | 14-11 |
| 14.2.5.2 | Setting a quantization level at manual acquisition | 14-12 |
| 14.2.5.3 | Setting a quantization level at automatic acquisition | 14-12 |
| 14.2.5.4 | Setting a gate size used for tracking | 14-12 |
| 14.2.5.5 | Displaying a TT limit ring | 14-12 |
| 14.2.6 | Adjusting MBS | 14-13 |
| 14.2.6.1 | Performing MBS adjustment | 14-13 |
| 14.2.6.2 | Adjusting an MBS application range | 14-13 |
| 14.3 | Verifying Installation and Initial Setting | 14-14 |
| 14.3.1 | Verifying/setting CCRP (Consistent Common Reference Point) | 14-14 |
| 14.3.1.1 | Setting CCRP | 14-14 |
| 14.3.2 | Setting a serial port | 14-16 |
| 14.3.2.1 | [Diagnosis] lamp light colours | 14-16 |
| 14.3.2.2 | Setting a serial port | 14-16 |
| 14.3.2.3 | To change the communication settings of the serial port | 14-19 |
| 14.3.3 | Setting own ship's parameters | 14-19 |
| 14.3.3.1 | Setting own ship's parameters | 14-20 |
| 14.3.4 | Setting the AIS password | 14-20 |
| 14.3.4.1 | Setting the AIS password | 14-20 |
| 14.4 | Maintenance | 14-21 |
| 14.4.1 | Managing storage | 14-21 |
| 14.4.2 | Maintaining the radar | 14-21 |
| 14.4.2.1 | Changing the operation mode of the safety switch | 14-21 |
| 14.4.2.2 | Clearing a radar antenna operation time | 14-22 |
| 14.4.2.3 | Replacing a TXRX circuit of a radar antenna | 14-22 |
| 14.4.3 | Initialising menu setting values | 14-24 |
| 14.4.3.1 | Initialising the settings other than equipment configuration | 14-24 |
| 14.4.3.2 | Initialising equipment configuration | 14-24 |
| 14.4.4 | Backing up the setup file | 14-24 |
| 14.4.4.1 | Backing up the setup file | 14-24 |
| Section 15 | Maintenance & Inspection | 15-1 |
| 15.1 | Maintenance Functions Executed from Menu | 15-1 |
| 15.1.1 | Setting Date/Time/Time zone | 15-1 |

| | | |
|----------|--|-------|
| 15.1.2 | Confirming system information | 15-2 |
| 15.1.3 | Checking the GPS status..... | 15-3 |
| 15.1.4 | Confirming operating time..... | 15-4 |
| 15.1.5 | Displaying/resetting the current voyage distance | 15-5 |
| 15.1.6 | Setting and confirming the sensor source | 15-5 |
| 15.1.6.1 | Setting the sensor source..... | 15-5 |
| 15.1.6.2 | Checking the sensor source status | 15-6 |
| 15.2 | General Maintenance | 15-7 |
| 15.3 | Maintenance on Each Unit | 15-8 |
| 15.3.1 | Radar antenna NKE-1130/A, NKE-1632/A, NKE-2632/A, NKE-2043, NKE-2063A, NKE-2103, NKE-2255 | 15-8 |
| 15.3.1.1 | Precautions in mounting the cover..... | 15-9 |
| 15.3.1.2 | Radiator | 15-11 |
| 15.3.1.3 | Rotating section | 15-11 |
| 15.3.2 | Display unit | 15-11 |
| 15.4 | Performance Check..... | 15-12 |
| 15.4.1 | Confirming the screen status [Monitor Test] | 15-13 |
| 15.4.2 | Confirming the operation of the operation unit [Key Test] | 15-14 |
| 15.4.3 | Confirming the alert sound [Sound Test] | 15-14 |
| 15.4.4 | Testing the brightness of LED [Light Test] | 15-15 |
| 15.4.5 | Checking the magnetron current level of the radar antenna [Magnetron Curr.] | 15-15 |
| 15.4.6 | Checking the memory [Memory Check] | 15-15 |
| 15.4.7 | Checking the performance monitor status..... | 15-16 |
| 15.4.7.1 | MON Check (NKE-2103, NKE-1130/A)..... | 15-16 |
| 15.4.7.2 | MON Check (NKE-2255)..... | 15-18 |
| 15.4.7.3 | MON Check (NKE-1632/A, NKE-2632/A, NKE-2632-H) | 15-19 |
| 15.4.8 | Checking radar information..... | 15-19 |
| 15.5 | Replacement of Major Parts | 15-20 |
| 15.5.1 | Parts expected for periodic replacement..... | 15-20 |
| 15.5.2 | Replacement of magnetron | 15-21 |
| 15.5.2.1 | Handling of magnetron under long-time storage | 15-21 |
| 15.5.2.2 | Magnetron replacement procedure for radar antenna NKE-1130/A | 15-22 |
| 15.5.2.3 | Magnetron replacement procedure for radar antenna NKE-2043 | 15-24 |
| 15.5.2.4 | Magnetron replacement procedure for radar antenna NKE-2063A | 15-31 |
| 15.5.2.5 | Magnetron replacement procedure for radar antenna NKE-2103 | 15-39 |
| 15.5.2.6 | Magnetron replacement procedure for radar antenna NKE-2255 | 15-42 |
| 15.5.3 | Replacing the motor | 15-44 |
| 15.5.3.1 | Motor replacement procedure for radar antenna NKE-1130/A | 15-44 |
| 15.5.3.2 | Motor replacement procedure for NKE-1632/A | 15-47 |
| 15.5.3.3 | Motor replacement procedure for NKE-2632/A, NKE-2632-H | 15-49 |
| 15.5.3.4 | Motor replacement procedure for NKE-2043..... | 15-53 |
| 15.5.3.5 | Motor replacement procedure for NKE-2063A | 15-56 |
| 15.5.3.6 | Motor replacement procedure for NKE-2103-4/4HS/6/6HS | 15-59 |

| | | |
|-------------------|--|-------------|
| 15.5.3.7 | Motor replacement procedure for NKE-2255-7/9/6HS | 15-62 |
| 15.6 | Software Update | 15-66 |
| 15.7 | Updating Help Data | 15-67 |
| 15.8 | Data Backup/Restore | 15-68 |
| 15.8.1 | Backing up data | 15-68 |
| 15.8.2 | Restoring backed up data..... | 15-69 |
| Section 16 | Failures and After-Sale Services | 16-1 |
| 16.1 | Failure Detection | 16-1 |
| 16.1.1 | About alerts..... | 16-1 |
| 16.1.2 | Alert description | 16-1 |
| 16.1.3 | Fuse inspection..... | 16-1 |
| 16.2 | Countermeasures for Failures | 16-2 |
| 16.2.1 | Special parts | 16-4 |
| 16.2.2 | Repair circuit block..... | 16-5 |
| 16.3 | Troubleshooting | 16-13 |
| 16.4 | After-Sale Services | 16-23 |
| 16.4.1 | About the retaining period of service parts..... | 16-23 |
| 16.4.2 | When requesting a repair | 16-23 |
| 16.4.3 | Recommendation of inspection and maintenance | 16-23 |
| 16.4.4 | Extending the functions | 16-25 |
| 16.4.4.1 | Importing the licence information | 16-25 |
| Section 17 | About Disposal..... | 17-1 |
| 17.1 | About Disposal of This Equipment..... | 17-1 |
| 17.2 | About Disposal of Used Magnetrons..... | 17-1 |
| 17.3 | Chinese Version RoHS..... | 17-2 |
| Section 18 | Specifications..... | 18-1 |
| 18.1 | JMR-5404-X..... | 18-1 |
| 18.2 | JMR-5406-X..... | 18-2 |
| 18.3 | JMR-5410-4X..... | 18-3 |
| 18.4 | JMR-5410-4XH | 18-4 |
| 18.5 | JMR-5410-6X..... | 18-5 |
| 18.6 | JMR-5410-6XH | 18-6 |
| 18.7 | JMR-5425-7X..... | 18-7 |
| 18.8 | JMR-5425-9X..... | 18-8 |
| 18.9 | JMR-5425-6XH | 18-9 |
| 18.10 | JMR-5430-S..... | 18-10 |
| 18.11 | JMR-5472-S..... | 18-11 |
| 18.12 | JMR-5482-S..... | 18-12 |
| 18.13 | JMR-5482-SH | 18-13 |

| | | |
|-------|-------------------------------|-------|
| 18.14 | NKE-2043 | 18-14 |
| 18.15 | NKE-2063A..... | 18-15 |
| 18.16 | NKE-2103 | 18-16 |
| 18.17 | NKE-2255 | 18-18 |
| 18.18 | NKE-1130/A | 18-20 |
| 18.19 | NKE-1632/A..... | 18-21 |
| 18.20 | NKE-2632/A..... | 18-22 |
| 18.21 | NJU-84 | 18-23 |
| 18.22 | NJU-85 | 18-23 |
| 18.23 | NJU-97 | 18-23 |
| 18.24 | Display Unit..... | 18-24 |
| 18.25 | Target Tracking | 18-26 |
| 18.26 | AIS..... | 18-27 |
| 18.27 | Process Unit..... | 18-28 |
| 18.28 | Standard Operation Unit..... | 18-29 |
| 18.29 | Trackball Operation Unit..... | 18-30 |
| 18.30 | Keyboard Operation Unit..... | 18-30 |
| 18.31 | 19inch Display..... | 18-31 |
| 18.32 | 26inch Display..... | 18-32 |
| 18.33 | Sensor LAN Switch Unit | 18-33 |
| 18.34 | Junction Box | 18-34 |

Appendix A Radar Antenna / Display Unit Block DiagramsA-1

| | | |
|--------|-----------------------------------|------|
| A.1 | Radar Antenna Block Diagrams..... | A-1 |
| A.1.1 | NKE-1130 (110 VAC)..... | A-1 |
| A.1.2 | NKE-1130 (220 VAC)..... | A-2 |
| A.1.3 | NKE-1130A | A-3 |
| A.1.4 | NKE-1632 | A-4 |
| A.1.5 | NKE-1632A..... | A-5 |
| A.1.6 | NKE-2632/2632-H..... | A-6 |
| A.1.7 | NKE-2632A | A-7 |
| A.1.8 | NKE-2255-7/9/6HS..... | A-8 |
| A.1.9 | NKE-2103-4/4HS/6/6HS..... | A-9 |
| A.1.10 | NKE-2063A..... | A-10 |
| A.1.11 | NKE-2043 | A-11 |
| A.2 | Display Unit Block Diagrams | A-12 |
| A.2.1 | NDC-1678/A process unit..... | A-12 |
| A.2.2 | NQA-2587 input/output unit | A-13 |
| A.2.3 | NCE-5794 operation unit | A-14 |

Appendix B Alert ListB-1

| | | |
|-----|--------------|-----|
| B.1 | Alarms | B-2 |
|-----|--------------|-----|

| | | |
|---|---|------------|
| B.2 | Warnings..... | B-3 |
| B.3 | Cautions..... | B-5 |
| B.4 | List of Alert escalation | B-6 |
| B.5 | List of Alert with responsibility-transferred state | B-7 |
| B.6 | List of Alert Icons..... | B-8 |
| Appendix C Setting the Inter switch..... | | C-1 |
| C.1 | Overview..... | C-1 |
| C.1.1 | Overview..... | C-1 |
| C.1.2 | Checking the connection status with the connected radar antennas..... | C-2 |
| C.2 | Inter switch Operations..... | C-3 |
| C.2.1 | Flow of operations..... | C-3 |
| C.2.2 | Opening the [Inter Switch] dialogue box..... | C-3 |
| C.2.3 | Checking the connection pattern | C-4 |
| C.2.3.1 | About equipment defect mark () and error notification mark ()..... | C-5 |
| C.2.4 | Changing the connection pattern | C-6 |
| C.2.5 | Changing the name of radar antenna or display unit | C-6 |
| C.2.6 | Using the set connection pattern | C-7 |
| C.3 | Reference | C-8 |
| C.3.1 | Pre-heat time after changing the connection pattern | C-8 |
| C.3.2 | Precautions while changing the connection pattern..... | C-8 |
| C.3.3 | Precautions during a slave connection..... | C-8 |
| C.3.4 | Setting during installation | C-9 |
| Appendix D Menu List and Materials | | D-1 |
| D.1 | Menu List..... | D-1 |
| D.1.1 | Anchor Watch | D-1 |
| D.1.2 | Chart | D-1 |
| D.1.3 | User Map..... | D-2 |
| D.1.4 | TT/AIS | D-3 |
| D.1.5 | Tools..... | D-6 |
| D.1.6 | View | D-9 |
| D.1.7 | Alert..... | D-15 |
| D.1.8 | Settings | D-16 |
| D.1.9 | Maintenance | D-24 |
| D.1.10 | Help..... | D-26 |
| D.1.11 | Code Input | D-26 |
| D.1.12 | Service | D-27 |
| D.2 | Context Menu List..... | D-32 |
| D.2.1 | No object | D-32 |
| D.2.2 | AIS..... | D-32 |
| D.2.2.1 | Sleeping AIS target | D-32 |
| D.2.2.2 | Activated AIS target..... | D-33 |

| | | |
|----------|---|------|
| D.2.2.3 | Numeric displayed AIS target | D-33 |
| D.2.2.4 | Normal AIS-SAR aircraft target..... | D-33 |
| D.2.2.5 | Numeric displayed AIS-SAR aircraft target | D-34 |
| D.2.2.6 | Sleeping AIS-SAR ship target..... | D-34 |
| D.2.2.7 | Activated AIS-SAR ship target | D-34 |
| D.2.2.8 | Numeric displayed AIS-SAR ship target..... | D-35 |
| D.2.2.9 | Sleeping AIS-SART target | D-35 |
| D.2.2.10 | Activated AIS-SART target..... | D-35 |
| D.2.2.11 | Numeric displayed AIS-SART target | D-36 |
| D.2.2.12 | Normal AIS-AtoN target..... | D-36 |
| D.2.2.13 | Numeric displayed AIS-AtoN target | D-36 |
| D.2.2.14 | Normal AIS-BS target..... | D-37 |
| D.2.2.15 | Numeric displayed AIS-BS target..... | D-37 |
| D.2.3 | TT..... | D-38 |
| D.2.3.1 | Internal TT | D-38 |
| D.2.3.2 | Internal TT - numeric display | D-38 |
| D.2.3.3 | External TT | D-38 |
| D.2.3.4 | External TT - detail information display | D-38 |
| D.2.4 | GPS Buoy..... | D-39 |
| D.2.4.1 | Normal GPS Buoy target..... | D-39 |
| D.2.4.2 | Numeric displayed GPS Buoy target | D-39 |
| D.2.5 | NAVTEX | D-39 |
| D.2.5.1 | NAVTEX | D-39 |
| D.2.6 | User Map..... | D-40 |
| D.2.6.1 | Mark | D-40 |
| D.2.6.2 | Line (Start point•End point)..... | D-40 |
| D.2.6.3 | Line (Midpoint)..... | D-40 |
| D.2.6.4 | Line (Line segment) | D-41 |
| D.2.6.5 | Line (Select all) | D-41 |
| D.2.6.6 | Text..... | D-41 |
| D.2.7 | Monitoring dragging anchor..... | D-42 |
| D.2.7.1 | Dragging anchor monitoring circle (Circumference) | D-42 |
| D.2.7.2 | Dragging anchor monitoring circle (Square of the four corners)..... | D-42 |
| D.2.7.3 | Dragging anchor monitoring polygon (Vertex)..... | D-42 |
| D.2.7.4 | Dragging anchor monitoring polygon (Line segment)..... | D-42 |
| D.2.7.5 | Dragging anchor monitoring polygon (Internal) | D-42 |
| D.3 | Abbreviations of Geodetic Data | D-43 |
| D.4 | Lists of Terminologies, Units, and Abbreviations | D-45 |
| D.5 | Icon Button List for User Map..... | D-53 |
| D.5.1 | Mark | D-53 |
| D.5.2 | Line | D-54 |
| D.5.3 | Text..... | D-54 |
| D.6 | List of Navigation - related Symbols | D-55 |

| | |
|---|------|
| D.6.1 Related to own ship symbols..... | D-55 |
| D.6.2 TT/AIS related..... | D-57 |
| D.6.3 Navigation monitoring related..... | D-58 |
| D.6.4 Tool related | D-58 |
| D.7 List of Icons / Icon Buttons | D-59 |
| D.8 Software Licence Agreement..... | D-64 |
| D.9 Font Licence Agreement | D-65 |
| D.10 IPA Font Licence Agreement v1.0..... | D-66 |



Section 1 Overview

WARNING



In case water or a metal object gets inside the equipment, turn off the power immediately, unplug the power supply cable from an electric outlet, and contact our head office, or a nearby branch or local office to request servicing.

Keeping the equipment in operation under such condition may cause a fire, an electric shock or a malfunction.



In case you find smoke, unusual odor or extreme high heat coming from the equipment, turn off the power immediately, unplug the power supply cable from an electric outlet, and contact our head office, or a nearby branch or local office to request servicing.

Keeping the equipment in operation under such condition may cause a fire or an electric shock.

CAUTION



Do not use or leave the equipment where there is a direct sunshine and high humidity or the temperature exceeds 55°C.

Otherwise, fire or other troubles may occur.



Do not put any container with water or small metallic object on this equipment.

Water may spill or metal may enter the equipment, causing fire, electric shock or other troubles.



Do not touch the equipment when your hands or gloves are wet with fresh water or seawater.

Otherwise, electric shock or other troubles may occur.

1.1 Functions

This marine radar equipment (referred to as "this equipment" in this manual) is navigation equipment that satisfies the following IMO performance standards except JMR-5404-X and JMR-5406-X.

- IMO Resolution MSC192(79): Radar performance standard
- IMO Resolution MSC191(79): Navigation information display
- IMO Resolution A.694(17): General requirements for marine radio facilities

Main functions

- Sensitivity adjustment, sea clutter and rain/snow clutter suppression
- Interference rejection
- Bearing and range measurement using a cursor, fixed/variable range markers, and electronic bearing line
- Coloured own track display
- User map creation and display
- TM (True Motion) presentation
- Self-diagnostic facilities
- Radar performance monitoring (Performance Monitor) *1
- Target tracking functions (manual/automatic target acquisition and tracking, vector and trail displays and alarm displays)
- 8-unit switchover (Interswitch) function (option)
- Chart display function*2 (option)

*1: JMR-5404-X and JMR-5406-X are excluded.

*2: The following databases can be displayed. JRC ROM card cannot use.

- C-MAP MAX
- Newpec

1.2 Features

This equipment has the following features:

Utilization of an icon menu

Intuitive operation system based on the workflow

High-resolution large screen

Message reception notification function

Notifies arrival of a new AIS message and so on with a badge.

Utilization of a common information window

Enables display of target information and simple conning information (wind direction/wind speed information, etc.) with a simple switching operation.

Display of chart information read results by grouping

Enables immediate access to the required information.

Display of the cause of alert as well as the action guideline

Equipped with the Help function

The built-in HTML Help enables the search of operation methods in this equipment instead of the hardcopy manual whenever required.

Visual highlight of target symbols

Enables identification of the target that matches the condition such as the sailing direction, ship's length, and ship's type by highlighted display.

Realized a clear large screen with its high resolution.

By using the high definition 26inch colour LCD of 1920×1200 pixels, radar image display of diameter 320mm or more is secured. Image presentation of high resolution is also possible in near ranges.

Equipped with high performance radar signal processing ASIC of new design

By eliminating unnecessary signals (clutters) from the radar video signals obtained from a wide dynamic range receiver with the latest digital signal processing technology, the target detection capability is ameliorated.

Target tracking (TT) function by utilizing the latest technology

By using the latest high-speed DSP and tracking algorithm, the target acquisition/tracking performance is improved, achieving stable operation for target tracking inside of clutters also.

- Capable of acquiring and tracking up to 100 targets by using an optional component (30 targets can be acquired/tracked as standard)
- Expressing danger status with a sound and shape and colour of a symbol
- Equipped with a trial manoeuvring function
- Capable of 10-colour coded display by storing target trails.

Background tracking function (Full-screen acquisition function)

Since detectable radar echoes are acquired and tracked automatically in background, the vector can be displayed immediately after initial acquisition.

Top screen with strictly selected information

Information that is constantly displayed on the Top screen of the radar is strictly selected to enable users to find the required information effortlessly.

Sortable TT/AIS list

Provides a sortable TT/AIS list (for instance in the TCPA descending order) to enable users to check the ship in the highest danger.

Dual PPI display

Capable of monitoring of near-range images and far-range images concurrently with one radar (only when a 26-inch monitor is used).

Superimposed display of radar image, chart, and own ship's trail

Capable of superimposed display of a user-created map, a chart of a coastline and buoys, own ship's trail, and other ship's trails, radar images, and radar trails in all the display modes including Head Up display.

Improved Day/Night function

The Day/Night function supports up to 5 types of display screen colour combinations and enables users to reproduce screen colours suitable for the user utilization environment with simple key operations. The function provides easy-to-understand screens through colour coded radar images and a variety of graphics.

Built-in self-diagnosis program

By constantly monitoring all the system functions, this program displays a warning message on the screen at detection of function deterioration and issues a warning sound. The system function test can be performed easily during normal operation (excluding some tests).

Performance monitor function

This function monitors radar performance (transmission output and reception sensitivity) on the screen.

JMR-5404-X and JMR-5406-X do not support performance monitor function.

Interswitch function (Option)

By connecting to the interswitch unit (optional), up to 8 radars can be inter-switched with simple operations. (To use the interswitch function, an interswitch unit independent of the display unit and a cable for connecting each display unit are required.)

1.3 Components

A list of components and optional accessories is shown below.

Components of the Display Unit

| Unit | | Type name | Q'ty | Remarks | | |
|---|--|---------------------------------|-----------------------------------|---|--|-----------------------|
| LCD Monitor | 26inch LCD Monitor Both AC and DC inputs supported | NWZ-208 | 1 | Standard equipment. Equipped with one of the three monitors. *1 | | |
| | 19inch LCD Monitor DC input | NWZ-214 | | | | |
| | 19inch LCD Monitor AC input | NWZ-214-AC | | | | |
| Control Unit | | | NCM-963 | 1 | Standard equipment | |
| | | | NDC-1678/A | 1 | Standard equipment | |
| | Processing Unit | COM Express Board | | CMC-1430/A | 1 | NDC-1678/A Components |
| | | Radar Processing Circuit | | CDC-1476/A | 1 | |
| | | SSD 16GB | | CDD-760 | 1 | |
| | | Terminal Board Circuit | | CQD-2322 | 1 | |
| | | | | NQA-2587 | 1 | |
| | | Interface Unit | Interface Circuit | CMH-2452 | 1 | NQA-2587 Components |
| | | | Interface Circuit Interconnection | CML-862 | 1 | |
| | | Power Supply Unit | | NBD-945 | 1 | NDC-1678/A components |
| | | Recovery Memory | | CDD-762 | 1 | |
| | | Processing Unit Interconnection | | CML-857 | 1 | |
| | WES7E License | | CYC-951 | 1 | | |
| | Operation Unit | | | NCE-5794 | 1 | Standard equipment |
| | | Operation Circuit A | | CCK-1096 | 1 | NCE-5794-E components |
| | | Operation Circuit B | | CCK-1097 | 1 | |
| | | Operation Circuit C | | CCK-1098 | 1 | |
| | | Operation Unit Interconnection | | CML-859 | 1 | |
| | | Trackball | | CCK-1101 | 1 | |
| | Display Unit Interconnection | | CML-858 | 1 | Standard equipment | |
| Trackball Operation Unit | | | NCE-5605 | 1 | Option | |
| | Operation Circuit A | | CCK-1050 | 1 | NCE-5605 components | |
| | Trackball | | CCK-1060 | 1 | | |
| | Operation Circuit SW | | CCK-1069 | 1 | | |
| | Operation Circuit CN | | CCK-1070 | 1 | | |
| | TOPU Interconnection | | CMD-1103 | 1 | | |
| Trackball Operation Unit Installation Cable | | 7ZCNA4152 | 1 | NCE-5605 components do not include the cable for connecting the processing unit. 5m cable | | |
| Keyboard Operation Unit | | | NCE-5625 | 1 | Option. This is an additional option for the trackball operation unit NCE-5605 which is an option. | |
| | Operation Circuit B | | CCK-1059 | 1 | NCE-5625 components | |
| | Option Keyboard | | CCK-1061 | 1 | | |
| | KOPU Interconnection | | CMD-1106 | 1 | | |
| Trackball/Keyboard Desktop Stand | | CWB-1596 | 1 | Option | | |

| Unit | | Type name | Q'ty | Remarks |
|---|------------------------------|------------------------|----------|---|
| Junction Box | | NQE-1143 | 1 | Option |
| | Serial LAN Interface Circuit | CMH-2370 | MAX 2 | |
| SENSOR LAN Switch | | NQA-2443/A | MAX 2 | Option |
| Monitor Stand | 26-inch Desktop Stand | CWB-1660 | 1 | For 26-inch monitor Option |
| | 19-inch Desktop Stand | CWB-1659 | | For 19-inch monitor Option |
| Rectifier | | NBA-5111 | 1 | Option |
| Interswitch Unit | 4ch | NQE-3141-4A | 1 | Option |
| | 8ch | NQE-3141-8A | 1 | Option |
| Power Control Unit | | NQE-3167 | 1 | Option |
| Junction Box | | NQE-3151A | | For NKE-1130/A radar antenna connection |
| Distributor for Remote Monitor Display Connection | Video Distribution Amplifier | VL-50004-120 US (100V) | 1 | Option |
| | | VL-50004-230V (220V) | | Option |
| | Monitor Extension Kit | CFQ-5957 | 1 | Option |
| Hood | 26-inch LCD Monitor Hood | CWB-1620 | 1 | Option |
| | 19-inch LCD Monitor Hood | CWB-1618 | | Option |

*1: When used as CAT1 / 1H, only 26 inch LCD monitor NWZ-208 can be selected.

| Unit | | Type name | Q'ty | Remarks | | | |
|--|---|--------------------------------|-----------|--|--|---|--------|
| Spare Parts | NDC-1678/A Processing Unit Fuse (F2/F3) | F2:ST4-3.15AN1 (5ZFCA00047) | 7ZXRD0012 | 1 | One box is packed in the package (3 pieces each). Either 7ZXRD0012, 7ZXRD0013, ZXRD0026 or 7ZXRD0015 is included according to the general type name. | | |
| | | F2:ST4-3.15AN1 (5ZFCA00047) | | | | | |
| | | F3:ST4-5AN1 (5ZFCA00050) | 7ZXRD0013 | | | | |
| | NKE-2063A Scanner Unit Carbon brush | 54531-01 (BRXP05247) | | | | | |
| | NDC-1678/A Processing Unit Fuse (F2/F3) | F2:S4-5AN1 (5ZFCA00050) | 7ZXRD0026 | | | | |
| | | F3:ST6-10AN1 (5ZFCA00053) | | | | | |
| | | F2:ST6-10AN1 (5ZFCA00053) | 7ZXRD0015 | | | | |
| | | F3:ST6-10AN1 (5ZFCA00053) | | | | | |
| | CMH-2370 Serial LAN Interface Circuit Spare Parts | | 7ZXNA4020 | | | 1 | Option |
| | 7HPNA4003 Printer Spare Parts | | 7ZXNA4011 | | | 1 | Option |
| Printer | Printer | 7HPNA4003 | 1 | Option | | | |
| | L Type Stopper (Printer Fixture) | QL-58 | 1 | | | | |
| Operation Unit RS-422 Extension Cable | 10m Cables | 7ZCRD1746 | MAX 2 | Option Neither USB device access nor chart card access in the operation unit using this cable is enabled. | | | |
| | 20m Cables | 7ZCRD1747 | | | | | |
| | 30m Cables | 7ZCRD1748 | | | | | |
| | 40m Cables | 7ZCRD1749 | | | | | |
| | 50m Cables (maximum length) | 7ZCRD1750 | | | | | |
| NSK Unit | | NCT-4106A | 1 | Option | | | |

Manual list

| General type name | Title | Code | Remark |
|-------------------|---------------------------------|-------------|--------------------|
| JMR-5400 series | Instruction Manual (English) | 7ZPRD0950*1 | Standard equipment |
| | Installation Manual (English) | 7ZPRD0953*1 | Standard equipment |
| | Quick Operation Guide (English) | 7ZPRD0955*1 | Standard equipment |
| | Field Service Manual (English) | 7ZPRD0954*1 | Option |

*1: Revision symbol (A, B, C, ...) is added to the end of each code.

List of Radar Antenna Types and Specifications

| Radar antenna type | Radio wave type | ft | Transmitting power | Band | Power supply | Rate of rotation | Category |
|--------------------|-----------------|-----|--------------------|------|--------------|------------------|-------------|
| NKE-1130/A | P0N | 12 | 30kW | S | AC | 24rpm | CAT 1/2*1 |
| NKE-1632/A | P0N,Q0N | 12 | 250W | S | AC | 24rpm | CAT 1/2*1 |
| NKE-2632/A | P0N,Q0N | 8 | 250W | S | AC | 24rpm | CAT 1/2*1 |
| NKE-2632-H | P0N,Q0N | 8 | 250W | S | AC | 48rpm | CAT 1H/2H*1 |
| NKE-2255-9 | P0N | 9 | 25kW | X | DC | 24rpm | CAT 1/2*1 |
| NKE-2255-7 | P0N | 7 | 25kW | X | DC | 24rpm | CAT 1/2*1 |
| NKE-2255-6HS | P0N | 6 | 25kW | X | DC | 48rpm | CAT 1H/2H*1 |
| NKE-2103-4 | P0N | 4 | 10kW | X | DC | 27rpm | CAT 1/2*1 |
| NKE-2103-4HS | P0N | 4 | 10kW | X | DC | 48rpm | CAT 1H/2H*1 |
| NKE-2103-6 | P0N | 6 | 10kW | X | DC | 27rpm | CAT 1/2*1 |
| NKE-2103-6HS | P0N | 6 | 10kW | X | DC | 48rpm | CAT 1H/2H*1 |
| NKE-2063A | P0N | 3.9 | 6kW | X | DC | 27rpm | Non-SOLAS |
| NKE-2043 | P0N | 2 | 4kW | X | DC | 48rpm | Non-SOLAS |

*1: When used as CAT1 / 1H, 26 inch LCD monitor and TT / AIS option are required.

Equipment composition and Ship's mains

| General type name | Radar antenna | Performance monitor | Display | Display unit | Ship's mains |
|---------------------------|---------------|---------------------|---|--|--|
| JMR-5404-X | NKE-2043 | — | 19inch | NCM-963 | 24VDC ^{*4} |
| JMR-5406-X | NKE-2063A | — | NWZ-214/ | NCM-963 | 24VDC ^{*4} |
| JMR-5410-4X | NKE-2103-4 | NJU-85 | NWZ-214-AC | NCM-963 | 24VDC ^{*4} |
| JMR-5410-4XH | NKE-2103-4HS | NJU-85 | or 26inch NWZ-208 ^{*5} | NCM-963 | 24VDC ^{*4} |
| JMR-5410-6X | NKE-2103-6 | NJU-85 | | NCM-963 | 24VDC ^{*4} |
| JMR-5410-6XH | NKE-2103-6HS | NJU-85 | | NCM-963 | 24VDC ^{*4} |
| JMR-5425-9X | NKE-2255-9 | NJU-97 | | NCM-963 | 24VDC ^{*4} |
| JMR-5425-7X | NKE-2255-7 | NJU-97 | | NCM-963 | 24VDC ^{*4} |
| JMR-5425-6XH | NKE-2255-6HS | NJU-97 | | NCM-963 | 24VDC ^{*4} |
| JMR-5430-S | NKE-1130/A | NJU-84 | | NCM-963 | 24VDC (supplied from NBA-5111) |
| | | | | NQE-3151A ^{*2} | 100-115VAC, 50/60Hz, 1 ϕ 220-240VAC, 50/60Hz, 1 ϕ |
| JMR-5472-S ^{*1} | NKE-1632/A | Built-in | | NCM-963 | 24VDC ^{*4} |
| | | | | NQE-3167 ^{*3} | 100-115VAC, 50/60Hz, 1 ϕ 220-240VAC, 50/60Hz, 1 ϕ |
| JMR-5482-S ^{*1} | NKE-2632/A | Built-in | NCM-963 | 24VDC ^{*4} | |
| | | | NQE-3167 ^{*3} | 100-115VAC, 50/60Hz, 1 ϕ 220-240VAC, 50/60Hz, 1 ϕ | |
| JMR-5482-SH ^{*1} | NKE-2632-H | Built-in | NCM-963 | 24VDC ^{*4} | |
| | | | NQE-3167 ^{*3} | 100-115VAC, 50/60Hz, 1 ϕ 220-240VAC, 50/60Hz, 1 ϕ | |

*1: JMR-5472-S, JMR-5482-S and JMR-5482-SH are solid state radars.

*2: The NQE-3151A that is included in JMA-5430-S is a connection unit for supplying AC power for motor to the radar antenna.

*3: NQE-3167 that is included in JMR-5472-S, JMR-5482-S, and JMR-5482-SH is a power control unit for supplying +48VDC and AC power for motor to the radar antenna.

*4: When using on-board power supply 100-120/220-240VAC, 50/60Hz, 1 ϕ , use rectifier NBA-5111 as the option.

*5: When used as CAT1 / 1H, only 26 inch LCD monitor NWZ-208 can be selected.

Option list of radar antennas

| Name | Model name | Remarks |
|----------------------|-------------|---|
| Performance monitor | NJU-84 | For S-band radars excluding NKE-1632/A, NKE-2632/A and 2632-H |
| | NJU-85 | For NKE-2103 |
| | NJU-97 | For NKE-2255 (Built-In) |
| 4-unit switching ISW | NQE-3141-4A | Separate unit |
| 8-unit switching ISW | NQE-3141-8A | Separate unit (special order) |
| Power control unit | NQE-3167 | Separate unit |

Note:

- The radar antenna can be equipped with anti-icing system (neck heater) as an option (not available for NKE-2103, NKE-2043, NKE-2063A), and '-D' shall be suffixed to the type name ('-D' or '-E' shall be suffixed to NKE-1632/A, NKE-2632/A, NKE-2632-H, NKE-2255, and NKE-2255-H.)

'-D' --- 100V AC (50/60Hz)

'-E' --- 200V AC (50/60Hz)

Reference:

The suffix(s) in the type name is/are changed by applying motor voltage, anti-icing system, etc.

(Example) NKE-1130-1D

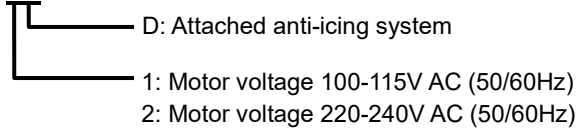

- The following are the each unit name on the one's plate:

| | |
|--------------------------|--------------------------|
| Scanner unit | SCANNER UNIT |
| Display unit | DISPLAY UNIT |
| Standard operation unit | STANDARD OPERATION UNIT |
| Trackball operation unit | TRACKBALL OPERATION UNIT |
| Keyboard operation unit | KEYBOARD OPERATION UNIT |
| Processing unit | RADAR PROCESS UNIT |
| Junction box | JUNCTION BOX |
| Sensor LAN switch unit | SENSOR LAN SWITCH UNIT |

1.4 Structure

The dimensional outline drawing of this equipment is shown below.

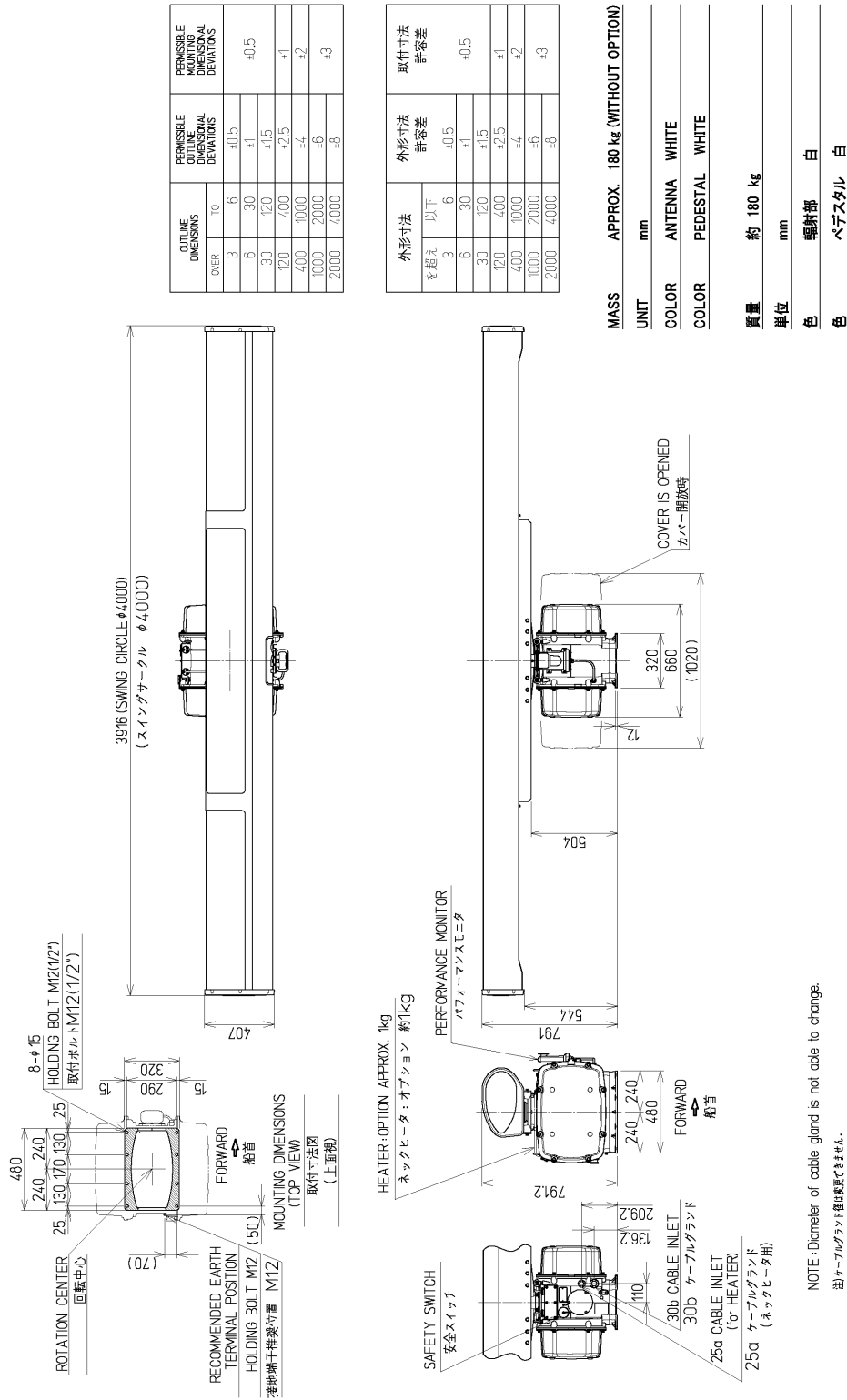

SCANNER UNIT OUTLINE DRAWING

NKE-1130/A

NOTE: Diameter of cable gland is not able to change.
注: ケーブルグラント径は変更できません。

SCNKE5312-2-⑥

Outline Drawing of Radar Antenna (NKE-1130/A)

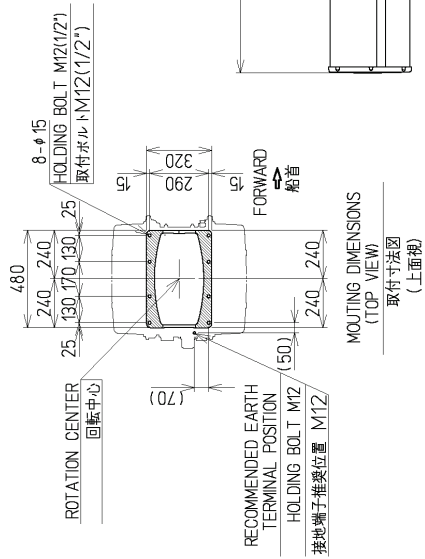

3916 (SWING CIRCLE φ4000)
(スイングサークル φ4000)

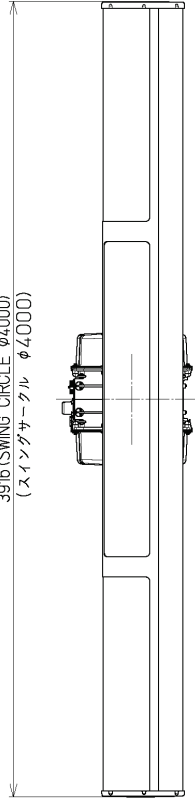

ROUTING DIMENSIONS
(TOP VIEW)
取付寸法図
(上面図)

| OUTLINE DIMENSIONS | | PERMISSIBLE DIMENSIONAL DEVIATIONS |
|--------------------|------|------------------------------------|
| OVER | TO | |
| 3 | 6 | +0.5 |
| 6 | 30 | ±1 |
| 30 | 120 | +1.5 |
| 120 | 400 | +2.5 |
| 400 | 1000 | +4 |
| 1000 | 2000 | +6 |
| 2000 | 4000 | +8 |

PERFORMANCE MONITOR
パフォーマンスモニター

HEATER:OPTION APPROX. 1kg
ネックヒータ:オプション 約1kg

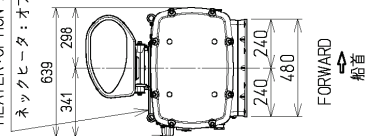

SAFETY SWITCH
安全スイッチ

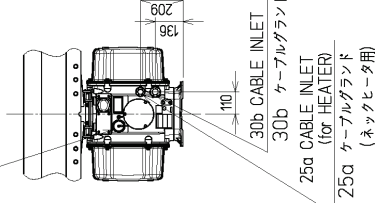

NOTE: Diameter of cable gland is not able to change.
注:ケーブルグランド径は変更できません。

| 外形寸法 | | 外形寸法許容差 | 取付寸法許容差 |
|------|------|---------|---------|
| を越え | を超え | | |
| 3 | 6 | ±0.5 | +0.5 |
| 6 | 30 | ±1 | |
| 30 | 120 | +1.5 | +1 |
| 120 | 400 | +2.5 | |
| 400 | 1000 | +4 | +2 |
| 1000 | 2000 | +6 | |
| 2000 | 4000 | +8 | +3 |

MASS APPROX. 160 kg (WITHOUT OPTION)

| UNIT | mm |
|----------------|-------|
| COLOR ANTENNA | WHITE |
| COLOR PEDESTAL | WHITE |

| | |
|----|-----------|
| 質量 | 約 160 kg |
| 単位 | mm |
| 色 | 輻射部 白 |
| 色 | ペDESTAL 白 |

SOLID STATE SCANNER UNIT OUTLINE DRAWING

NKE-1632/A

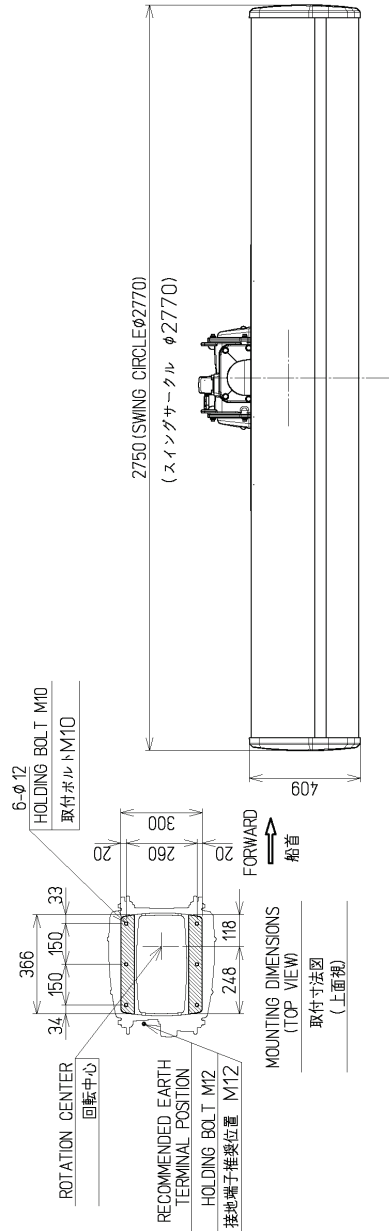

| OVER | OUTLINE DIMENSIONS | | PERMISSIBLE OUTLINE DIMENSIONAL DEVIATIONS | PERMISSIBLE MOUNTING DIMENSIONAL DEVIATIONS |
|------|--------------------|--|--|---|
| | TO | | | |
| 3 | 6 | | ±0.5 | |
| 6 | 30 | | ±1 | +0.5 |
| 30 | 120 | | ±1.5 | |
| 120 | 400 | | ±2.5 | ±1 |
| 400 | 1000 | | ±4 | ±2 |
| 1000 | 2000 | | ±6 | ±3 |
| 2000 | 4000 | | ±8 | |

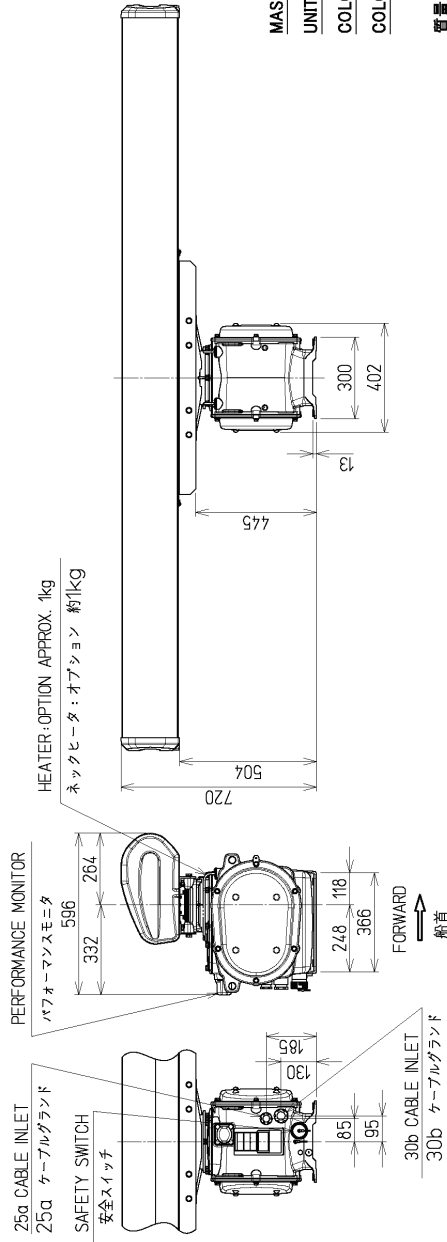

| 外形寸法 | 許容差 | 取付寸法 | 許容差 |
|------|------|------|------|
| | | | |
| 3 | 6 | | ±0.5 |
| 6 | 30 | | ±1 |
| 30 | 120 | | ±1.5 |
| 120 | 400 | | ±2.5 |
| 400 | 1000 | | ±4 |
| 1000 | 2000 | | ±6 |
| 2000 | 4000 | | ±8 |

| | |
|-------|--------------------------------|
| MASS | APPROX. 85 kg (WITHOUT OPTION) |
| UNIT | mm |
| COLOR | ANTENNA WHITE |
| COLOR | PEDESTAL WHITE |
| 質量 | 約 85 kg |
| 単位 | mm |
| 色 | 輻射部 白 |
| 色 | ベースタル 白 |

SOLID STATE SCANNER UNIT OUTLINE DRAWING **NKE-2632/A**

NOTE: Diameter of cable gland is not able to change.
注: ケーブルグラウンド径は変更できません。

Outline Drawing of Radar Antenna (NKE-2632/A)

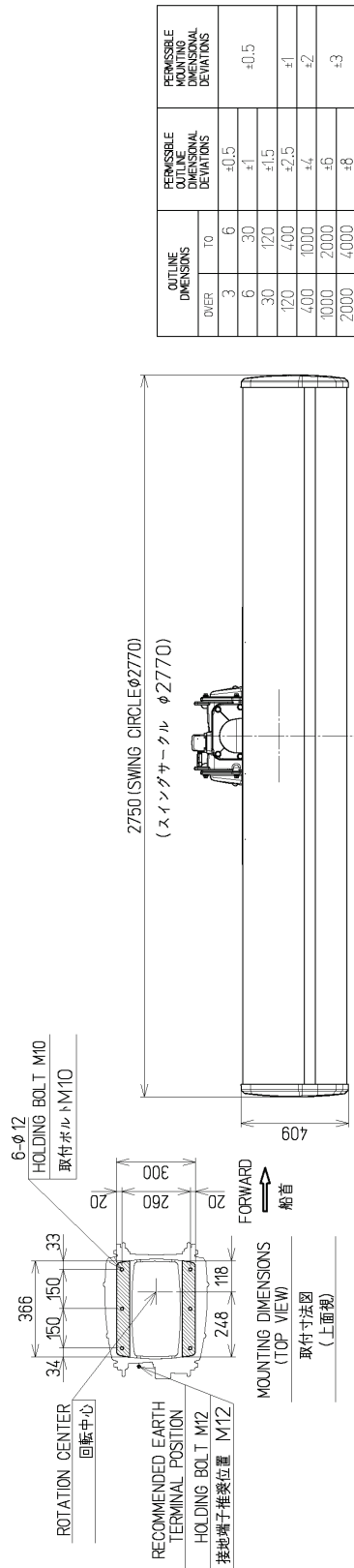

| OUTLINE DIMENSIONS | PERMISSIBLE MOUNTING POSITIONAL DEVIATIONS | |
|--------------------|--|------|
| | OVER | TO |
| 3 | 6 | ±0.5 |
| 6 | 30 | ±1 |
| 30 | 120 | ±1.5 |
| 120 | 400 | ±2.5 |
| 400 | 1000 | ±4 |
| 1000 | 2000 | ±6 |
| 2000 | 4000 | ±8 |

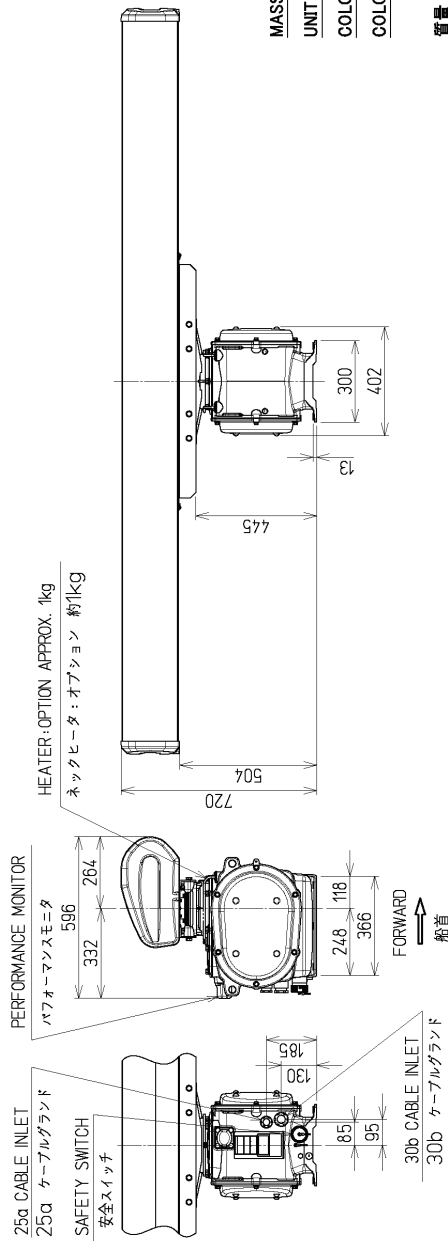

| 外形寸法 | 外形寸法 許容差 | | 取付寸法 許容差 |
|------|----------|------|----------|
| | を 超え | を 超え | |
| 3 | 6 | ±0.5 | ±0.5 |
| 6 | 30 | ±1 | |
| 30 | 120 | ±1.5 | ±1 |
| 120 | 400 | ±2.5 | |
| 400 | 1000 | ±4 | ±2 |
| 1000 | 2000 | ±6 | |
| 2000 | 4000 | ±8 | ±3 |

| | |
|-------|--------------------------------|
| MASS | APPROX. 90 kg (WITHOUT OPTION) |
| UNIT | mm |
| COLOR | ANTENNA WHITE |
| COLOR | PEDESTAL WHITE |
| 質量 | 約 90 kg |
| 単位 | mm |
| 色 | 輻射部 白 |
| 色 | ペダスタル 白 |

SOLID STATE SCANNER UNIT OUTLINE DRAWING

NKE-2632-H

NOTE: Diameter of cable gland is not able to change.
注: ケーブルグラント径は変更できません。

Outline Drawing of Radar Antenna (NKE-2632-H)

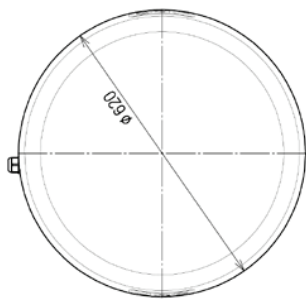
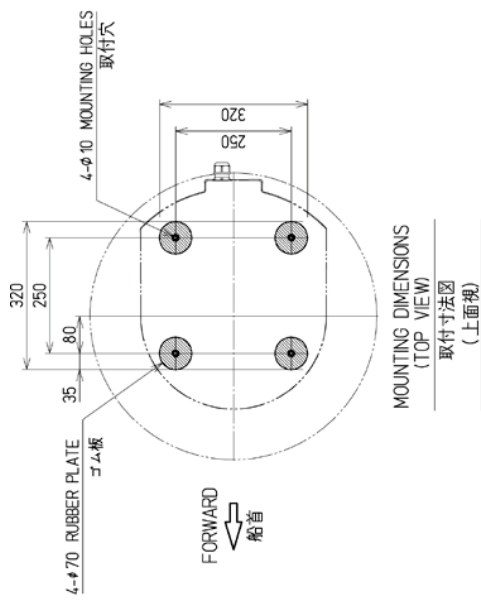

FORWARD
船首

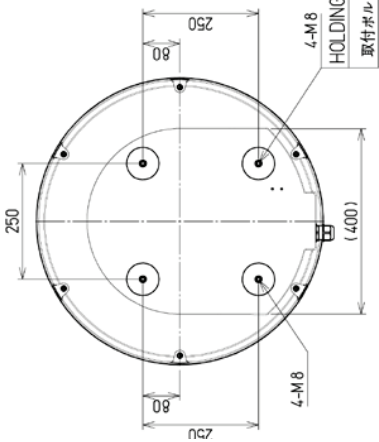
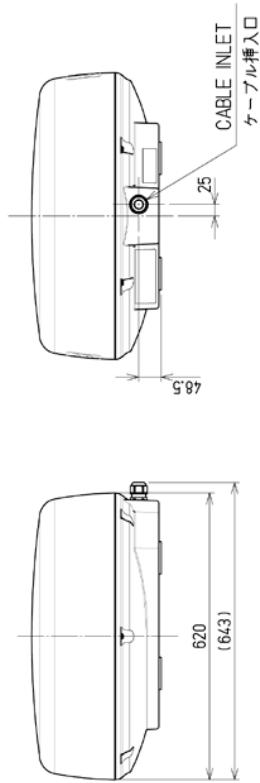

| OVER | OUTLINE DIMENSIONS | | PERMISSIBLE OUTLINE DIMENSIONAL DEVIATIONS | PERMISSIBLE MOUNTING DIMENSIONAL DEVIATIONS |
|------|--------------------|------|--|---|
| | TO | FROM | | |
| 3 | 6 | | ±0.5 | |
| 6 | 30 | | ±1 | +0.5 |
| 30 | 120 | | ±1.5 | |
| 120 | 400 | | ±2.5 | ±1 |
| 400 | 1000 | | ±4 | ±2 |
| 1000 | 2000 | | ±6 | |
| 2000 | 4000 | | ±8 | ±3 |

| を 超え | 外形寸法 | | 外形寸法 許容差 | 取付寸法 許容差 |
|---------|------|----|-------------|-------------|
| | 以下 | 以上 | | |
| 3 | 6 | | ±0.5 | |
| 6 | 30 | | ±1 | +0.5 |
| 30 | 120 | | ±1.5 | |
| 120 | 400 | | ±2.5 | ±1 |
| 400 | 1000 | | ±4 | ±2 |
| 1000 | 2000 | | ±6 | |
| 2000 | 4000 | | ±8 | ±3 |

MASS APPROX. 10 kg

UNIT mm

COLOR WHITE

質量 約 10 kg

単位 mm

色 白

NKE-2043

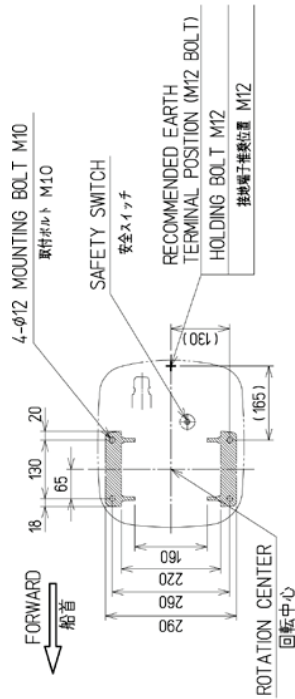

MOUNTING DIMENSIONS
(TOP VIEW)
取付寸法図
(上面視)

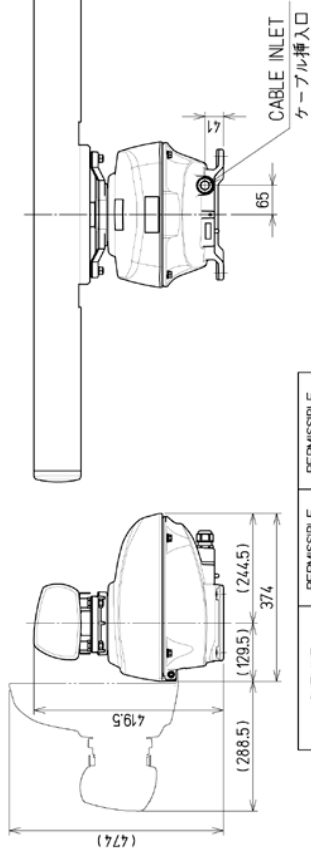
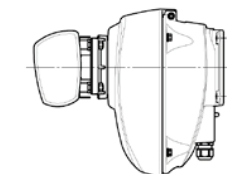
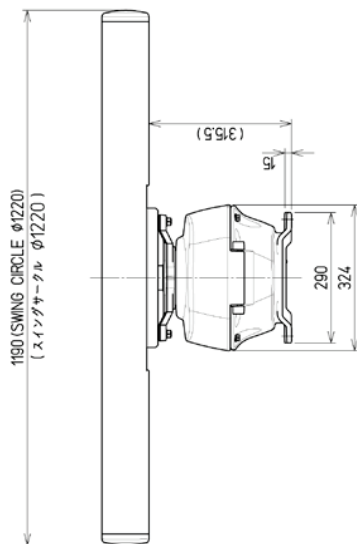

| OUTLINE DIMENSIONS | PERMISSIBLE OUTLINE DIMENSIONAL DEVIATIONS | | PERMISSIBLE MOUNTING DIMENSIONAL DEVIATIONS | |
|--------------------|--|----|---|------|
| | OVER | TO | | |
| 3 | 6 | | ±0.5 | |
| 6 | 30 | | ±1 | ±0.5 |
| 30 | 120 | | ±1.5 | |
| 120 | 400 | | ±2.5 | ±1 |
| 400 | 1000 | | ±4 | ±2 |
| 1000 | 2000 | | ±6 | |
| 2000 | 4000 | | ±8 | ±3 |

| 外形寸法 | 取付寸法 | | 外形寸法 | | 取付寸法 | |
|------|------|----|------|-----|------|-----|
| | を越え | 以下 | 許容差 | 許容差 | 許容差 | 許容差 |
| 3 | 6 | | ±0.5 | | ±0.5 | |
| 6 | 30 | | ±1 | | | |
| 30 | 120 | | ±1.5 | | | |
| 120 | 400 | | ±2.5 | | ±1 | |
| 400 | 1000 | | ±4 | | ±2 | |
| 1000 | 2000 | | ±6 | | | |
| 2000 | 4000 | | ±8 | | ±3 | |

| | |
|-------|----------------|
| MASS | APPROX. 21 kg |
| UNIT | mm |
| COLOR | ANTENNA WHITE |
| COLOR | PEDESTAL WHITE |
| 質量 | 約 21 kg |
| 単位 | mm |
| 色 | 輻射部 白 |
| 色 | ベースタル 白 |

NKE-2063A

Outline Drawing of Radar Antenna (NKE-2063A)

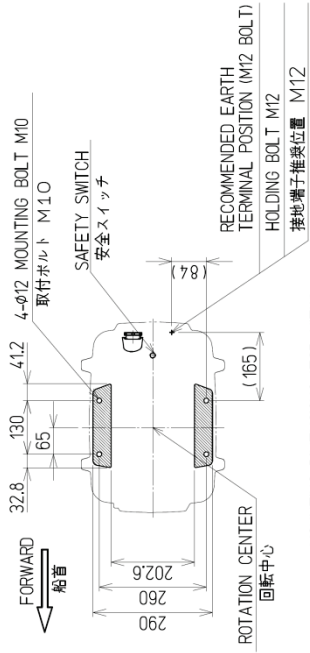
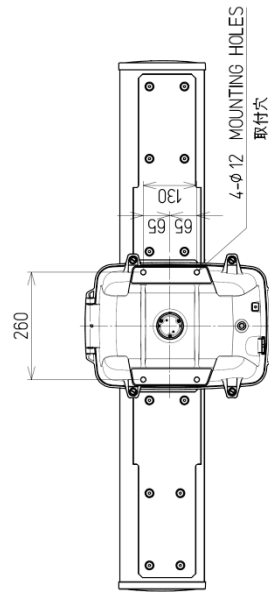
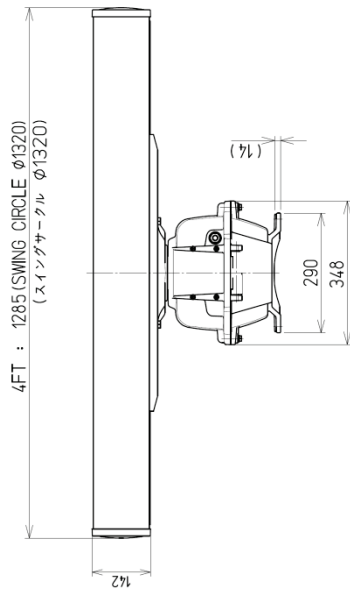
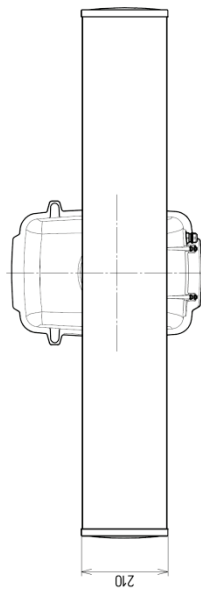

MOUNTING DIMENSIONS (TOP VIEW)
取付寸法図 (上面視)

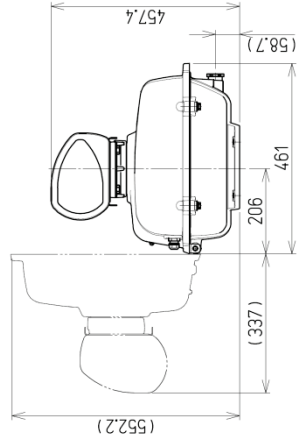

| OUTLINE DIMENSIONS | | PERMISSIBLE OUTLINE DIMENSIONAL DEVIATIONS | PERMISSIBLE MOUNTING DIMENSIONAL DEVIATIONS |
|--------------------|------|--|---|
| OVER | TO | | |
| 3 | 6 | ±0.5 | ±0.5 |
| 6 | 30 | ±1 | |
| 30 | 120 | ±1.5 | ±1 |
| 120 | 400 | ±2.5 | |
| 400 | 1000 | ±4 | ±2 |
| 1000 | 2000 | ±6 | |
| 2000 | 4000 | ±8 | ±3 |

| 外形寸法 を越え 以下 | 外形寸法 許容差 | |
|-------------------|-------------|------|
| | 取付寸法 許容差 | |
| 3 | 6 | ±0.5 |
| 6 | 30 | ±1 |
| 30 | 120 | ±1.5 |
| 120 | 400 | ±2.5 |
| 400 | 1000 | ±4 |
| 1000 | 2000 | ±6 |
| 2000 | 4000 | ±8 |

| | |
|-------|----------------|
| MASS | APPROX. 34 kg |
| UNIT | mm |
| COLOR | ANTENNA WHITE |
| COLOR | PEDESTAL WHITE |
| 質量 | 約 34 kg |
| 単位 | mm |
| 色 | レーザ部 白 |
| 色 | ベースタル 白 |

Outline Drawing of Radar Antenna (NKE-2103-4/4HS)

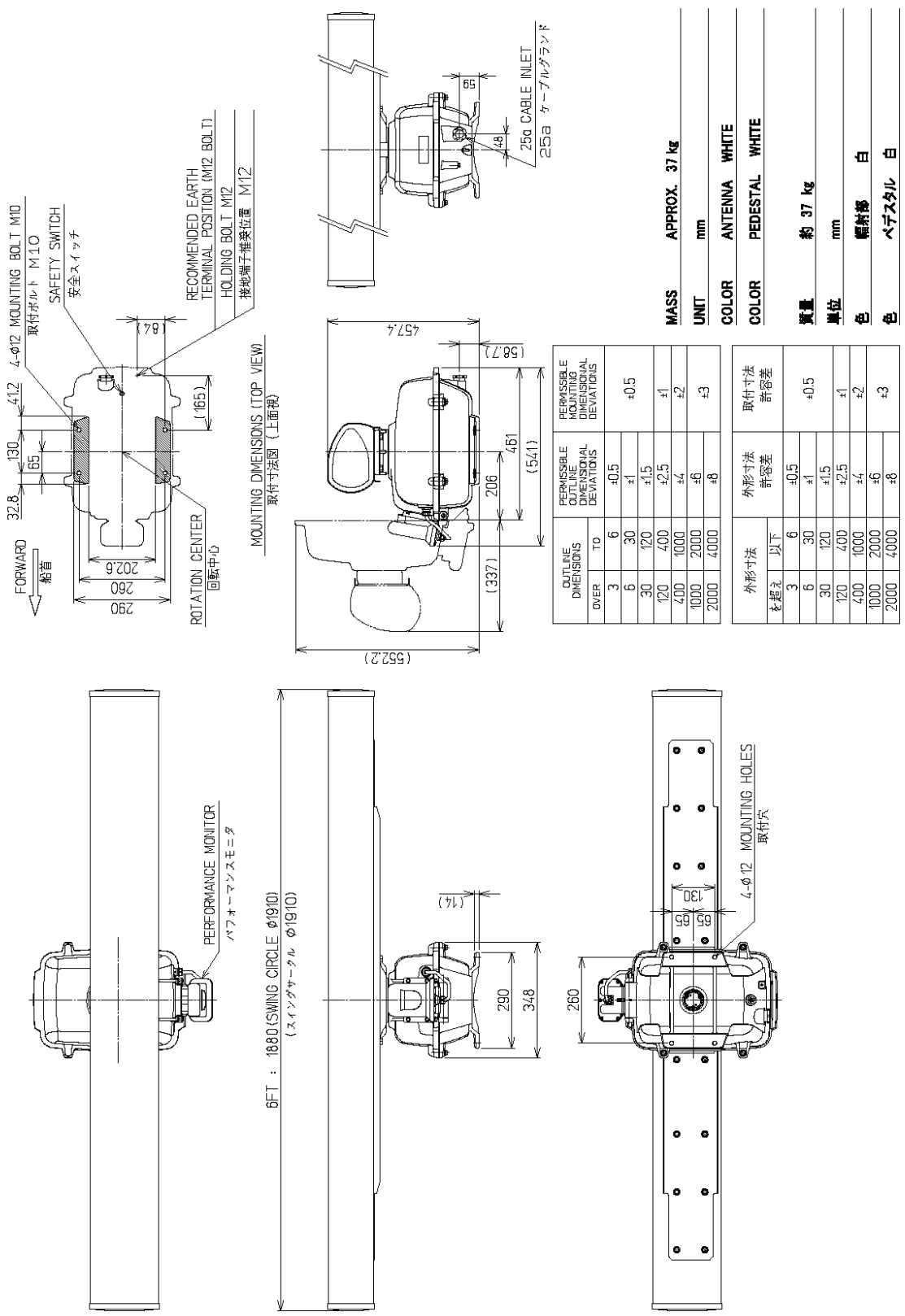

SCNKE5303-3

SCANNER UNIT OUTLINE DRAWING

NKE-2103-6/NKE-2103-6HS

Outline Drawing of Radar Antenna (NKE-2103-6/6HS)

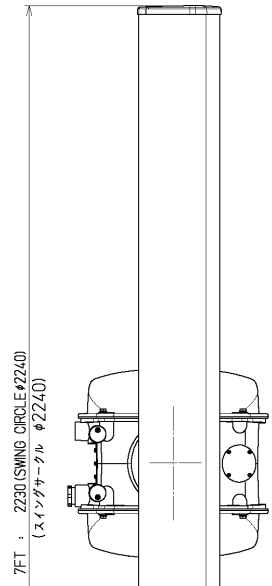
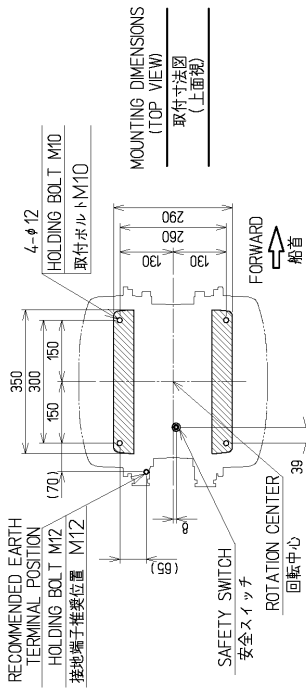

| OUTLINE DIMENSIONS | | PERMISSIBLE OUTLINE DIMENSIONAL DEVIATIONS | PERMISSIBLE MOUNTING DIMENSIONAL DEVIATIONS |
|--------------------|------|--|---|
| OVER | TO | | |
| 3 | 6 | +0.5 | |
| 6 | 30 | +1 | +0.5 |
| 30 | 120 | +1.5 | +1 |
| 120 | 400 | +2.5 | +2 |
| 400 | 1000 | +4 | +3 |
| 1000 | 2000 | +6 | +3 |
| 2000 | 4000 | +8 | +3 |

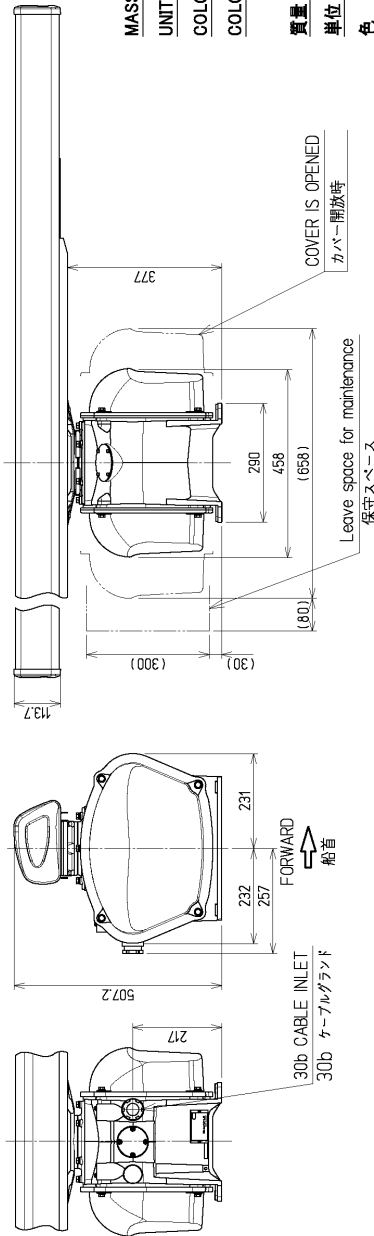

| 外形寸法 | | 外形寸法許容差 | 取付寸法許容差 |
|------|------|---------|---------|
| を起え | 以下 | | |
| 3 | 6 | +0.5 | |
| 6 | 30 | +1 | +0.5 |
| 30 | 120 | +1.5 | +1 |
| 120 | 400 | +2.5 | +2 |
| 400 | 1000 | +4 | +3 |
| 1000 | 2000 | +6 | +3 |
| 2000 | 4000 | +8 | +3 |

| | |
|-------|----------------|
| MASS | APPROX. 52 kg |
| UNIT | mm |
| COLOR | ANTENNA WHITE |
| COLOR | PEDESTAL WHITE |
| 質量 | 約 52 kg |
| 単位 | mm |
| 色 | 輻射部 白 |
| 色 | ペDESTAL 白 |

NOTE: Diameter of cable gland is not able to change.
 (注) ケーブルグランド径は変更できません。

SCANNER UNIT OUTLINE DRAWING

NKE-2255-7

SONKE5368-1-②

Outline Drawing of Radar Antenna (NKE-2255-7)

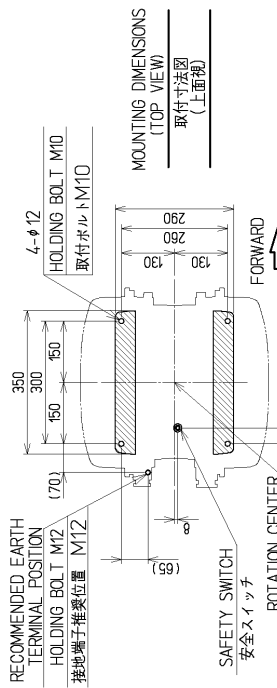

| OUTLINE DIMENSIONS | | PERMISSIBLE MOUNTING POSITIONAL DEVIATIONS | PERMISSIBLE MOUNTING POSITIONAL DEVIATIONS |
|--------------------|------|--|--|
| OVER | TO | | |
| 3 | 6 | +0.5 | |
| 6 | 30 | ±1 | ±0.5 |
| 30 | 120 | ±1.5 | |
| 120 | 400 | ±2.5 | ±1 |
| 400 | 1000 | ±4 | ±2 |
| 1000 | 2000 | ±6 | ±3 |
| 2000 | 4000 | ±8 | |

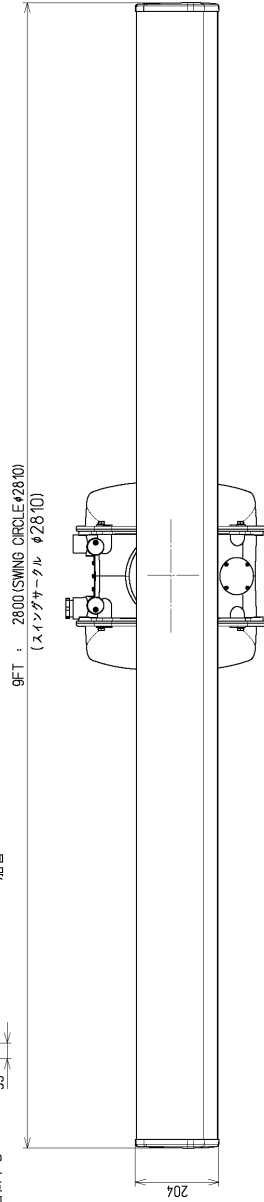

| 外形寸法 | | 外形寸法許容差 | 取付寸法許容差 |
|------|------|---------|---------|
| を超越 | 以下 | | |
| 3 | 6 | +0.5 | |
| 6 | 30 | ±1 | ±0.5 |
| 30 | 120 | ±1.5 | |
| 120 | 400 | ±2.5 | ±1 |
| 400 | 1000 | ±4 | ±2 |
| 1000 | 2000 | ±6 | ±3 |
| 2000 | 4000 | ±8 | |

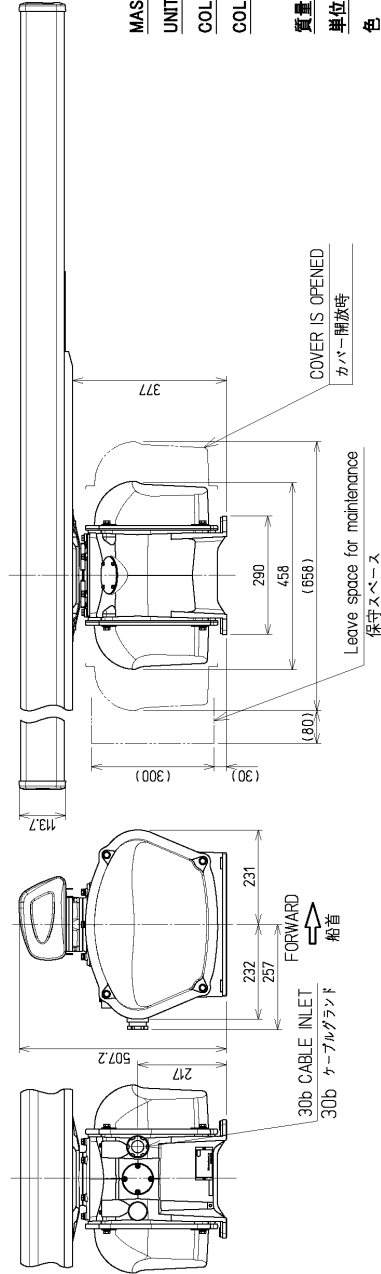

| | |
|-------|----------------|
| MASS | APPROX. 55 kg |
| UNIT | mm |
| COLOR | ANTENNA WHITE |
| COLOR | PEDESTAL WHITE |
| 質量 | 約 55 kg |
| 単位 | mm |
| 色 | 輻射部 白 |
| 色 | ペDESTAL 白 |

NOTE : Diameter of cable gland is not able to change.
 注) ケーブルグラント径は変更できません。

SCANNER UNIT OUTLINE DRAWING

SCNKE5369-1-0

NKE-2255-9

Outline Drawing of Radar Antenna (NKE-2255-9)

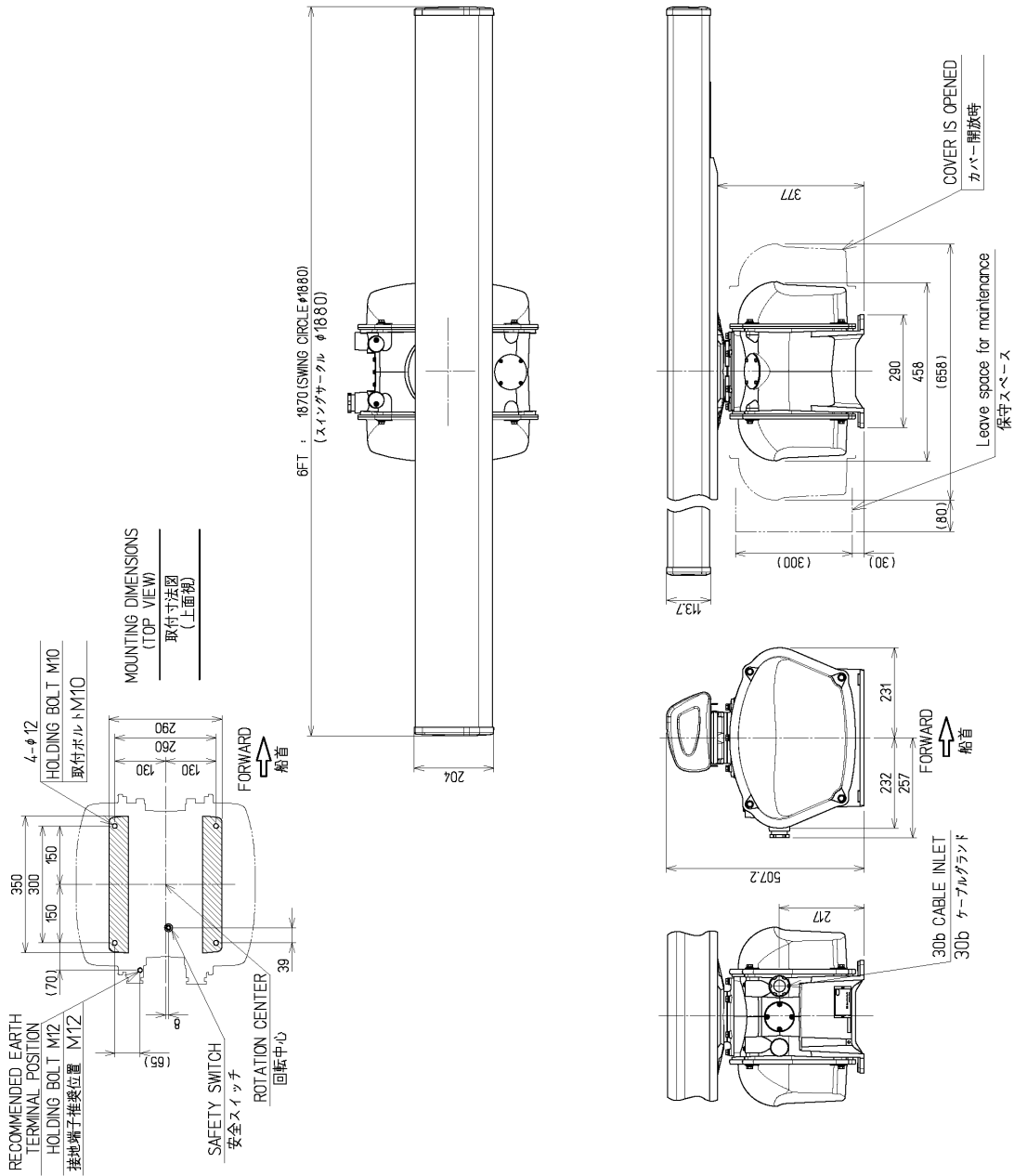

Outline Drawing of Radar Antenna (NKE-2255-6HS)

| OUTLINE DIMENSIONS | | PERMISSIBLE OUTLINE DIMENSIONAL DEVIATIONS | PERMISSIBLE MOUNTING DIMENSIONAL DEVIATIONS |
|--------------------|------|--|---|
| DIVER | TO | | |
| 3 | 6 | +0.5 | +0.5 |
| 6 | 30 | ±1 | |
| 30 | 120 | ±1.5 | ±1 |
| 120 | 400 | ±2.5 | |
| 400 | 1000 | ±4 | ±2 |
| 1000 | 2000 | ±6 | |
| 2000 | 4000 | ±8 | ±3 |

| 外形寸法 を 超え | 外形寸法 許容差 | | 取付寸法 許容差 |
|-----------------|-------------|------|-------------|
| | 以下 | | |
| 3 | 6 | +0.5 | +0.5 |
| 6 | 30 | ±1 | |
| 30 | 120 | ±1.5 | ±1 |
| 120 | 400 | ±2.5 | |
| 400 | 1000 | ±4 | ±2 |
| 1000 | 2000 | ±6 | |
| 2000 | 4000 | ±8 | ±3 |

| | |
|-------|----------------|
| MASS | APPROX. 50 kg |
| UNIT | mm |
| COLOR | ANTENNA WHITE |
| COLOR | PEDESTAL WHITE |
| 質量 | 約 50 kg |
| 単位 | mm |
| 色 | 輻射部 白 |
| 色 | ペDESTAL 白 |

SCANNER UNIT OUTLINE DRAWING

NKE-2255-6HS

NOTE : Diameter of cable gland is not able to change.
 注) ケーブルグランド径は変更できません。

SC/NKE5267-1-0

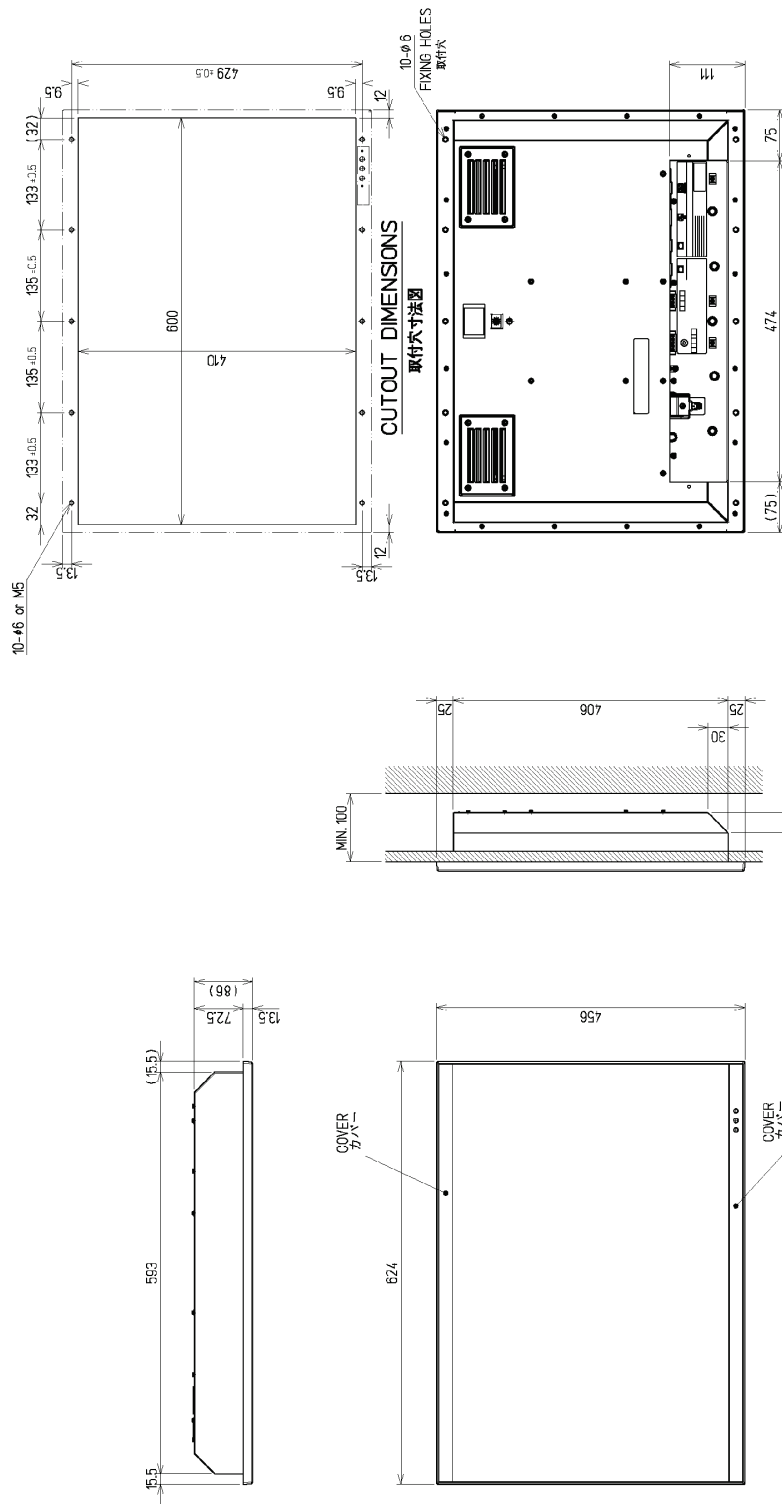

Outline drawing of 26inch Display (NWZ-208)

| 外形寸法 表記 | 外形寸法 許容差 | | 取付寸法 許容差 |
|------------|-------------|------|-------------|
| | 以下 | 以上 | |
| 2 | 6 | +0.5 | 40.b |
| 6 | 30 | +1 | |
| 30 | 120 | +1.5 | +1 |
| 120 | 400 | +2.5 | |
| 400 | 1000 | +4 | +2 |
| 1000 | 2000 | +6 | |
| 2000 | 4000 | +8 | +3 |

| OUTLINE DIMENSIONS | | PERMISSIBLE OUTLINE DIMENSIONAL DEVIATIONS | PERMISSIBLE MOUNTING DIMENSIONAL DEVIATIONS |
|-----------------------|------|---|--|
| COVER | TC | | |
| 2 | 6 | +0.5 | 40.b |
| 6 | 30 | +1 | |
| 30 | 120 | +1.5 | +1 |
| 120 | 400 | +2.5 | |
| 400 | 1000 | +4 | +2 |
| 1000 | 2000 | +6 | |
| 2000 | 4000 | +8 | +3 |

MASS APPROX. 16 kg
UNIT mm
質量 約 16 kg
単位 mm

NWZ-208

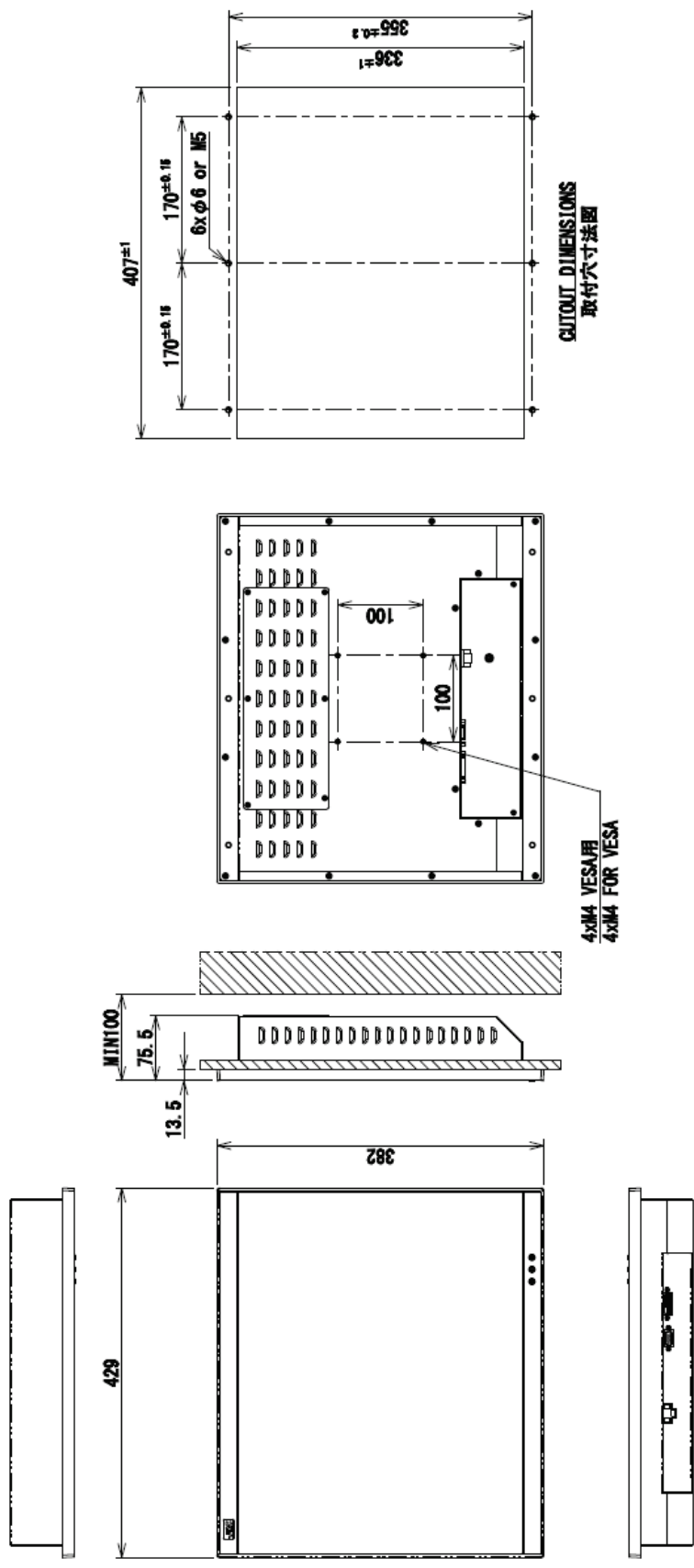

CUTOUT DIMENSIONS
取付穴寸法图

| 外形寸法 を種え | 外形寸法 許容差 | | 取付寸法 許容差 |
|-------------|-------------|------|-------------|
| | 以下 | | |
| 3 | 6 | ±0.5 | ±0.5 |
| 6 | 30 | ±1 | |
| 30 | 120 | ±1.5 | ±1 |
| 120 | 400 | ±2.5 | |
| 400 | 1000 | ±4 | ±2 |
| 1000 | 2000 | ±6 | |
| 2000 | 4000 | ±8 | ±3 |

| OUTLINE DIMENSIONS | | PERMISSIBLE OUTLINE DIMENSIONAL DEVIATIONS | PERMISSIBLE MOUNTING DIMENSIONAL DEVIATIONS |
|--------------------|------|--|---|
| OVER | TO | | |
| 3 | 6 | ±0.5 | ±0.5 |
| 6 | 30 | ±1 | |
| 30 | 120 | ±1.5 | ±1 |
| 120 | 400 | ±2.5 | |
| 400 | 1000 | ±4 | ±2 |
| 1000 | 2000 | ±6 | |
| 2000 | 4000 | ±8 | ±3 |

MASS APPROX. 4.6kg
UNIT mm
質量 約 4.6kg
単位 mm

NWZ-214

Outline drawing of 19inch Display (NWZ-214)

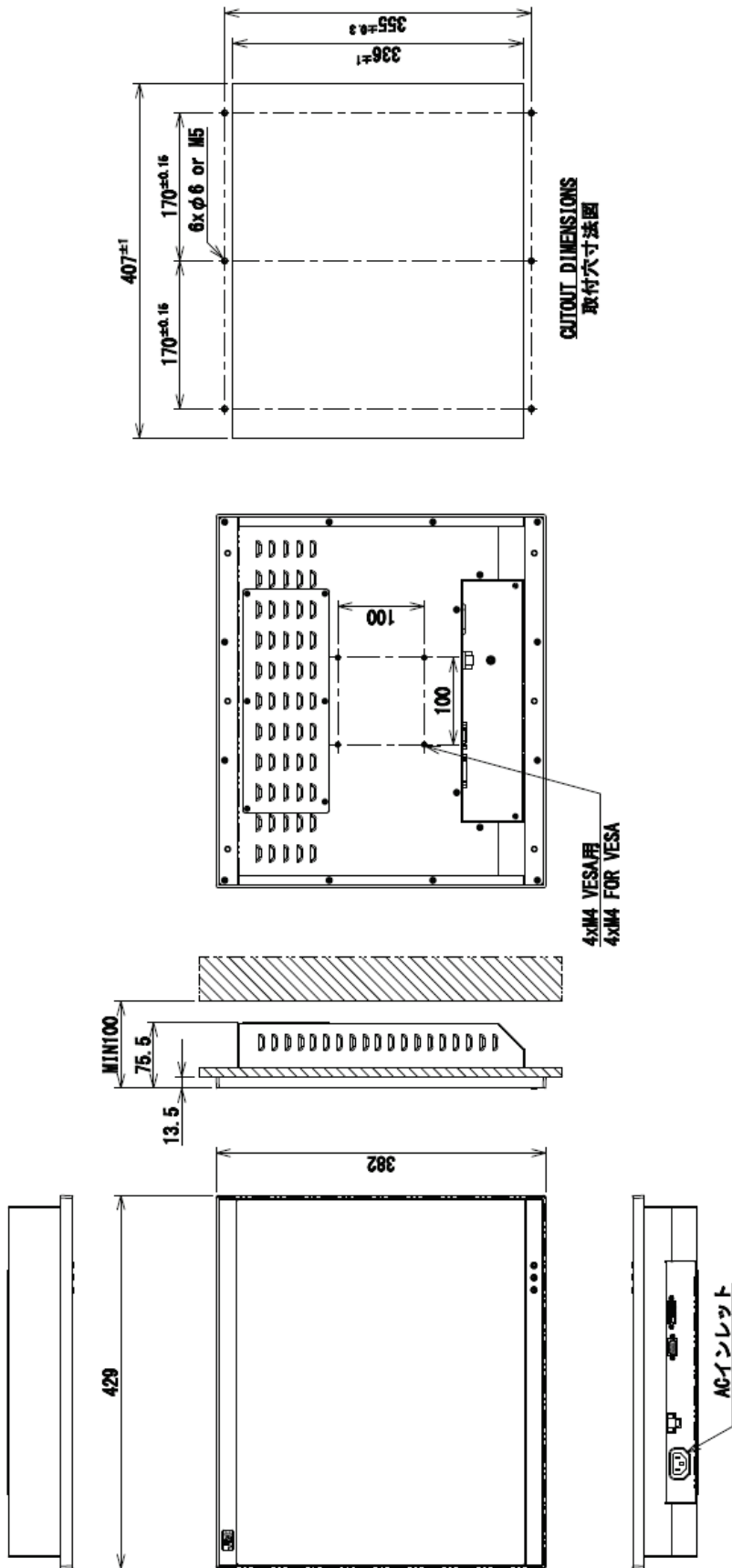

CUTOUT DIMENSIONS
取付穴寸法図

4xM4 VESA用
4xM4 FOR VESA

ACインレット

MASS APPROX. 4.9kg
UNIT mm
質量 約 4.9kg
単位 mm

NWZ-214-AC

| 外形寸法 お超え 以下 | 外形寸法 許容差 | | 取付寸法 許容差 | |
|----------------|-------------|------|-------------|------|
| | 3 | 6 | ±0.5 | ±0.5 |
| 6 | 30 | ±1 | ±0.5 | ±0.5 |
| 30 | 120 | ±1.5 | ±1.5 | ±1 |
| 120 | 400 | ±2.5 | ±2.5 | ±1 |
| 400 | 1000 | ±4 | ±4 | ±2 |
| 1000 | 2000 | ±6 | ±6 | ±3 |
| 2000 | 4000 | ±8 | ±8 | ±3 |

| OUTLINE DIMENSIONS | | PERMISSIBLE OUTLINE DIMENSIONAL DEVIATIONS | | PERMISSIBLE MOUNTING DIMENSIONAL DEVIATIONS | |
|-----------------------|------|---|------|--|----|
| OVER | TO | ±0.5 | ±1 | ±0.5 | ±1 |
| 3 | 6 | ±0.5 | ±1 | ±0.5 | ±1 |
| 6 | 30 | ±1 | ±1.5 | ±1 | ±1 |
| 30 | 120 | ±1.5 | ±2.5 | ±1 | ±1 |
| 120 | 400 | ±2.5 | ±4 | ±2 | ±2 |
| 400 | 1000 | ±4 | ±6 | ±2 | ±2 |
| 1000 | 2000 | ±6 | ±8 | ±3 | ±3 |
| 2000 | 4000 | ±8 | | ±3 | |

Outline drawing of 19inch Display (NWZ-214-AC)

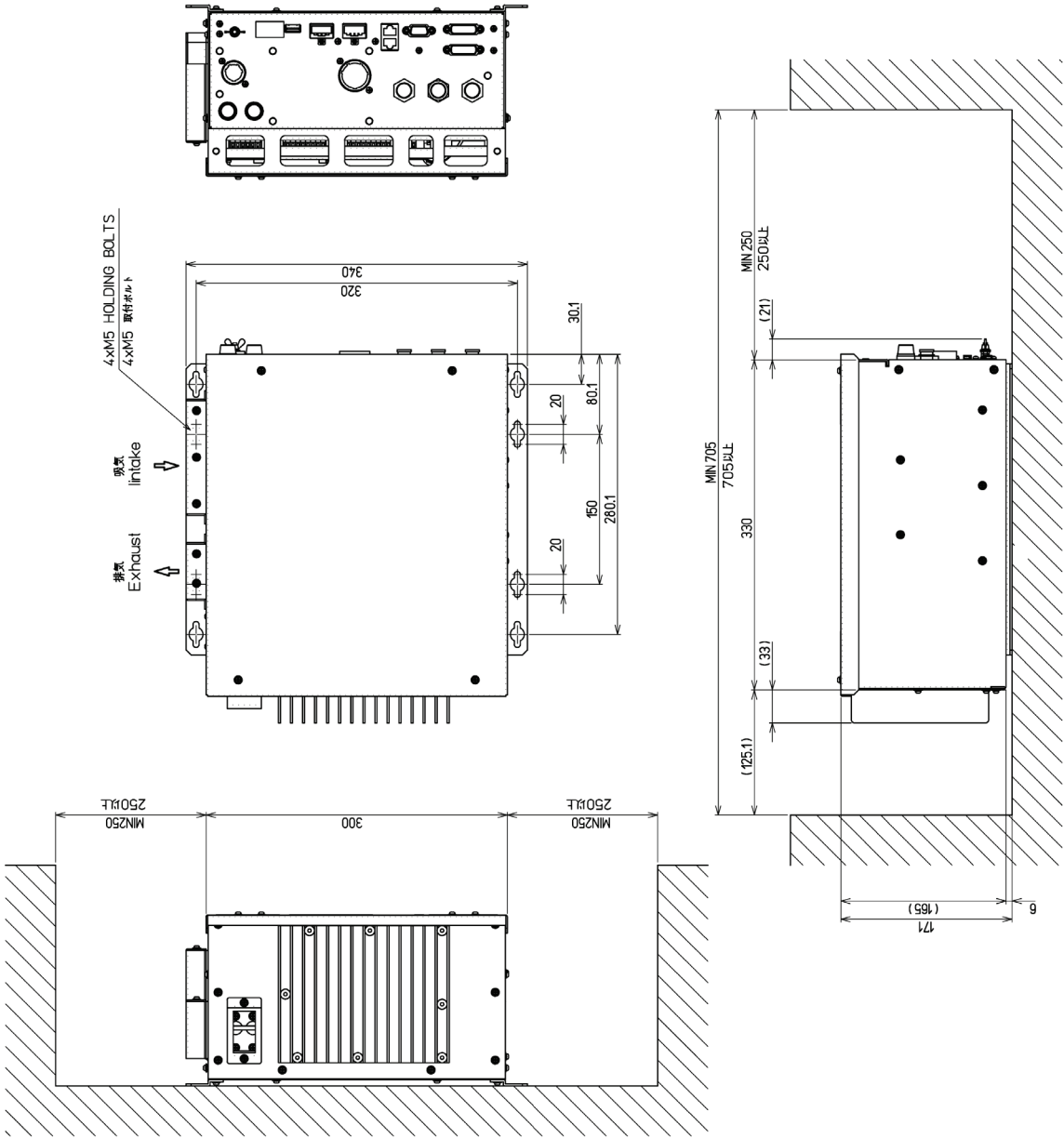

Outline Drawing of Process Unit (NDC-1678/A)

| OUTLINE DIMENSIONS | | PERMISSIBLE OUTLINE DIMENSIONAL DEVIATIONS | PERMISSIBLE MOUNTING DIMENSIONAL DEVIATIONS |
|--------------------|------|--|---|
| OVER | TO | | |
| 3 | 6 | ±0.5 | ±0.5 |
| 6 | 30 | ±1 | |
| 30 | 120 | ±1.5 | ±1 |
| 120 | 400 | ±2.5 | |
| 400 | 1000 | ±4 | ±2 |
| 1000 | 2000 | ±6 | |
| 2000 | 4000 | ±8 | ±3 |

| 外形寸法 | | 外形寸法 許容差 | 取付寸法 許容差 |
|------|------|----------|----------|
| を超え | 以下 | | |
| 3 | 6 | ±0.5 | ±0.5 |
| 6 | 30 | ±1 | |
| 30 | 120 | ±1.5 | ±1 |
| 120 | 400 | ±2.5 | |
| 400 | 1000 | ±4 | ±2 |
| 1000 | 2000 | ±6 | |
| 2000 | 4000 | ±8 | ±3 |

MASS APPROX. 7.1 kg
 UNIT mm
 質量 約 7.1 kg
 単位 mm

NDC-1678/A

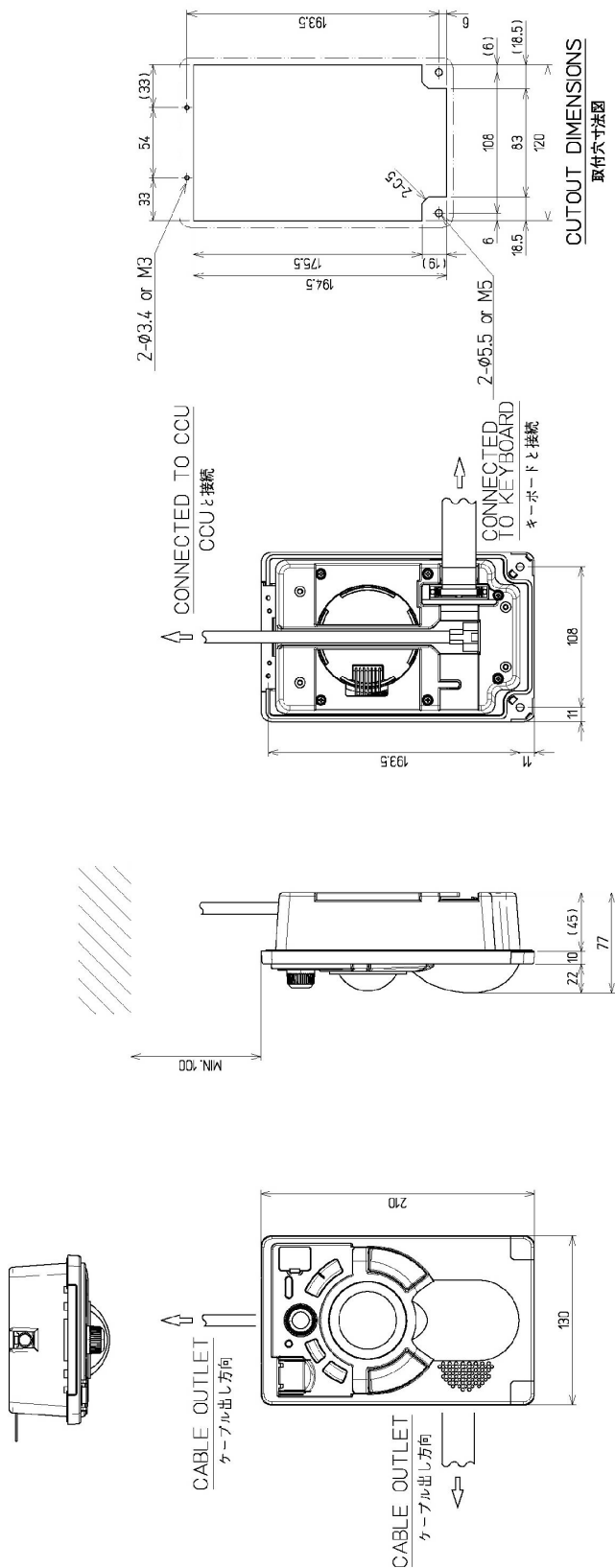

Outline Drawing of Trackball Operation Unit (NCE-5605) (Option)

| 外形寸法 を越え | 外形寸法 許容差 | | 取付寸法 許容差 |
|-------------|-------------|------|-------------|
| | 以下 | | |
| 3 | 6 | +0.5 | ±0.5 |
| 6 | 30 | ±1 | |
| 30 | 120 | ±1.5 | ±1 |
| 170 | 400 | +2.5 | ±2 |
| 400 | 1000 | +4 | ±3 |
| 1000 | 2000 | +6 | |
| 2000 | 4000 | +8 | |

| OUTLINE DIMENSIONS | | PERMISSIBLE DIMENSIONAL DEVIATIONS | PERMISSIBLE DIMENSIONAL DEVIATIONS |
|-----------------------|------|--|--|
| OVER | TO | | |
| 3 | 6 | +0.5 | ±0.5 |
| 6 | 30 | ±1 | |
| 30 | 120 | ±1.5 | ±1 |
| 120 | 400 | +2.5 | ±2 |
| 400 | 1000 | +4 | ±3 |
| 1000 | 2000 | +6 | |
| 2000 | 4000 | +8 | |

| | |
|------|----------------|
| MASS | APPROX. 1.3 kg |
| UNIT | mm |
| 質量 | 約 1.3 kg |
| 単位 | mm |

SCNCE5367

TRACKBALL OPERATION UNIT OUTLINE DRAWING

NCE-5605

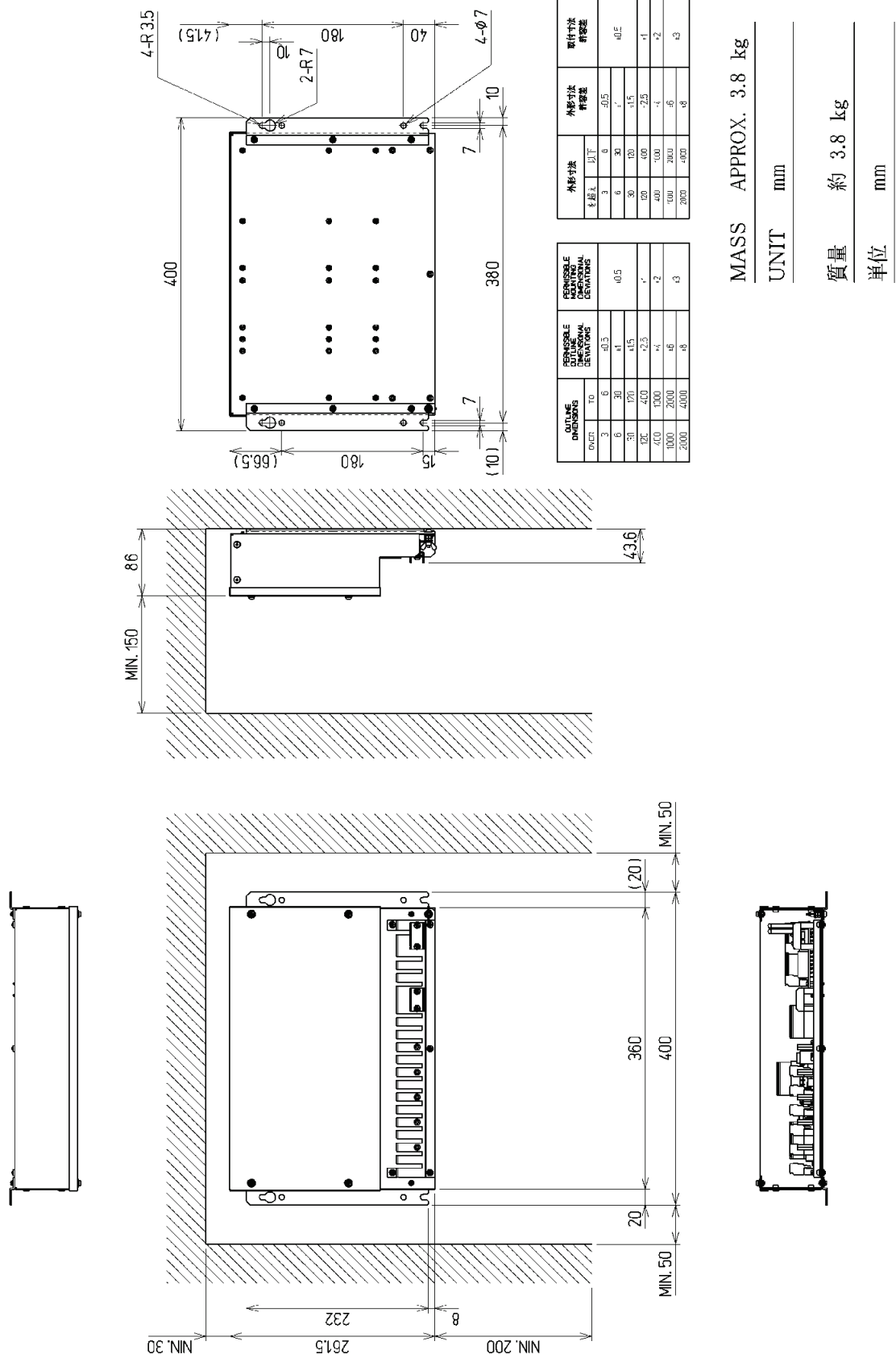

SCNQE5093-0

JUNCTION BOX OUTLINE DRAWING

NQE-1143

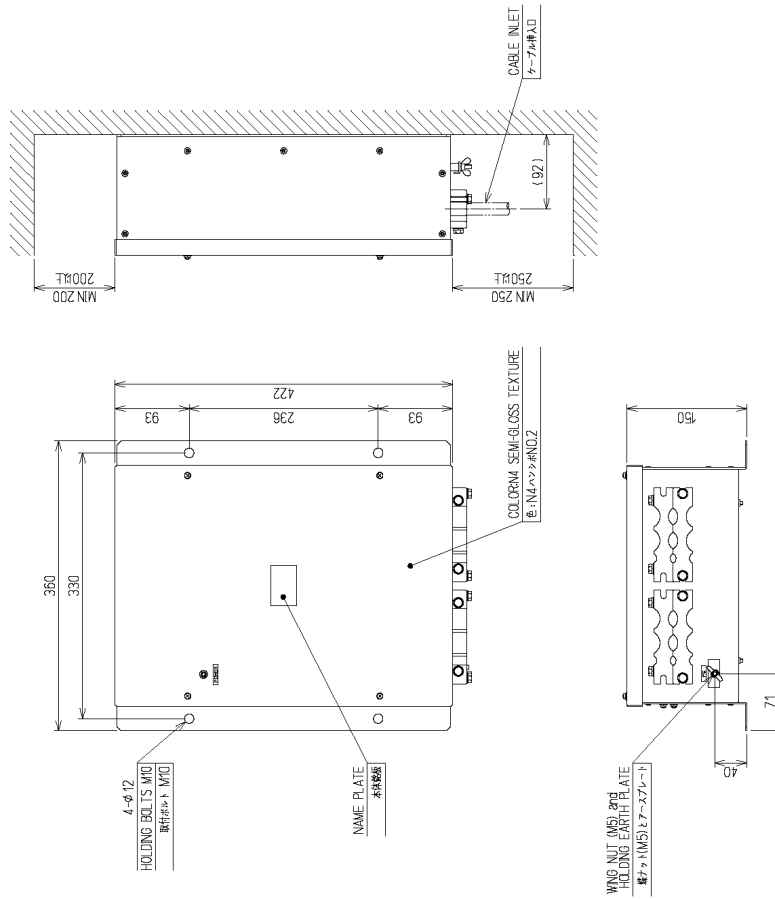
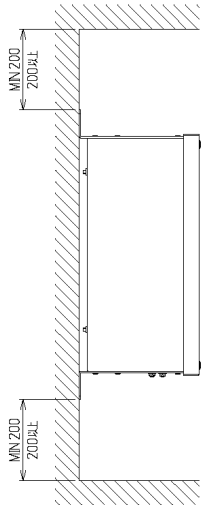

| OUTLINE DIMENSIONS OVER | PERMISSIBLE DIMENSIONAL DEVIATIONS | |
|-------------------------|------------------------------------|------|
| | TO | |
| 3 | 6 | ±0.5 |
| 6 | 30 | ±1 |
| 30 | 120 | ±1.5 |
| 120 | 400 | ±2.5 |
| 400 | 1000 | ±4 |
| 1000 | 2000 | ±6 |
| 2000 | 4000 | ±8 |

| 外形寸法 表記 | 外形寸法 許容差 | |
|---------|----------|------|
| | 以下 | |
| 3 | 6 | ±0.5 |
| 6 | 30 | ±1 |
| 30 | 120 | ±1.5 |
| 120 | 400 | ±2.5 |
| 400 | 1000 | ±4 |
| 1000 | 2000 | ±6 |
| 2000 | 4000 | ±8 |

MASS APPROX. 6 kg

UNIT mm

質量 約 6 kg

単位 mm

Outline Drawing of Interswitch Unit (NQE-3141-4A) (Option)

INTERSWITCH UNIT OUTLINE DRAWING

NQE-3141-4A

SCNQE5084

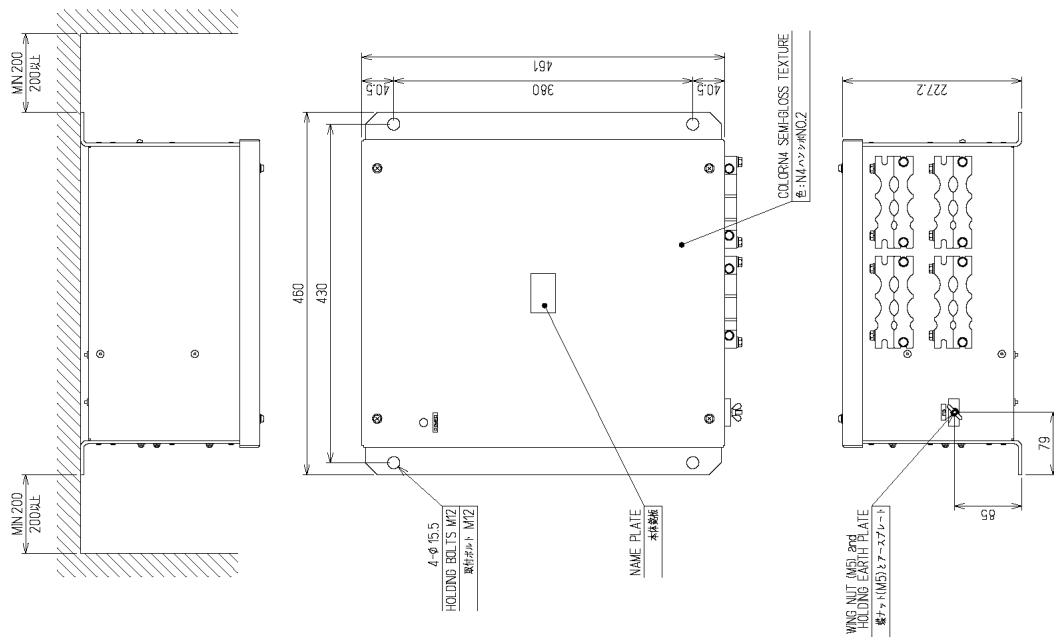

| OUTLINE DIMENSIONS | | PERMISSIBLE DIMENSIONAL DEVIATIONS | PERMISSIBLE DIMENSIONAL DEVIATIONS |
|--------------------|------|------------------------------------|------------------------------------|
| OVER | TO | | |
| 3 | 6 | ±0.5 | ±0.5 |
| 6 | 30 | ±1 | |
| 30 | 120 | ±1.5 | ±1 |
| 120 | 400 | ±2.5 | |
| 400 | 1000 | ±4 | ±2 |
| 1000 | 2000 | ±6 | |
| 2000 | 4000 | ±8 | ±3 |

| 外形寸法 | | 外形寸法許容差 | 取付寸法許容差 |
|------|------|---------|---------|
| 元起点 | 以下 | | |
| 3 | 6 | ±0.5 | ±0.5 |
| 6 | 30 | ±1 | |
| 30 | 120 | ±1.5 | ±1 |
| 120 | 400 | ±2.5 | |
| 400 | 1000 | ±4 | ±2 |
| 1000 | 2000 | ±6 | |
| 2000 | 4000 | ±8 | ±3 |

MASS APPROX. 12 kg

UNIT mm

質量 約 12 kg

単位 mm

Outline Drawing of Interswitch Unit (NQE-3141-8A) (Option)

INTERSWITCH UNIT OUTLINE DRAWING

NQE-3141-8A

SCNQE5085

1.5 General System Diagrams

Connection examples of this equipment are shown below.

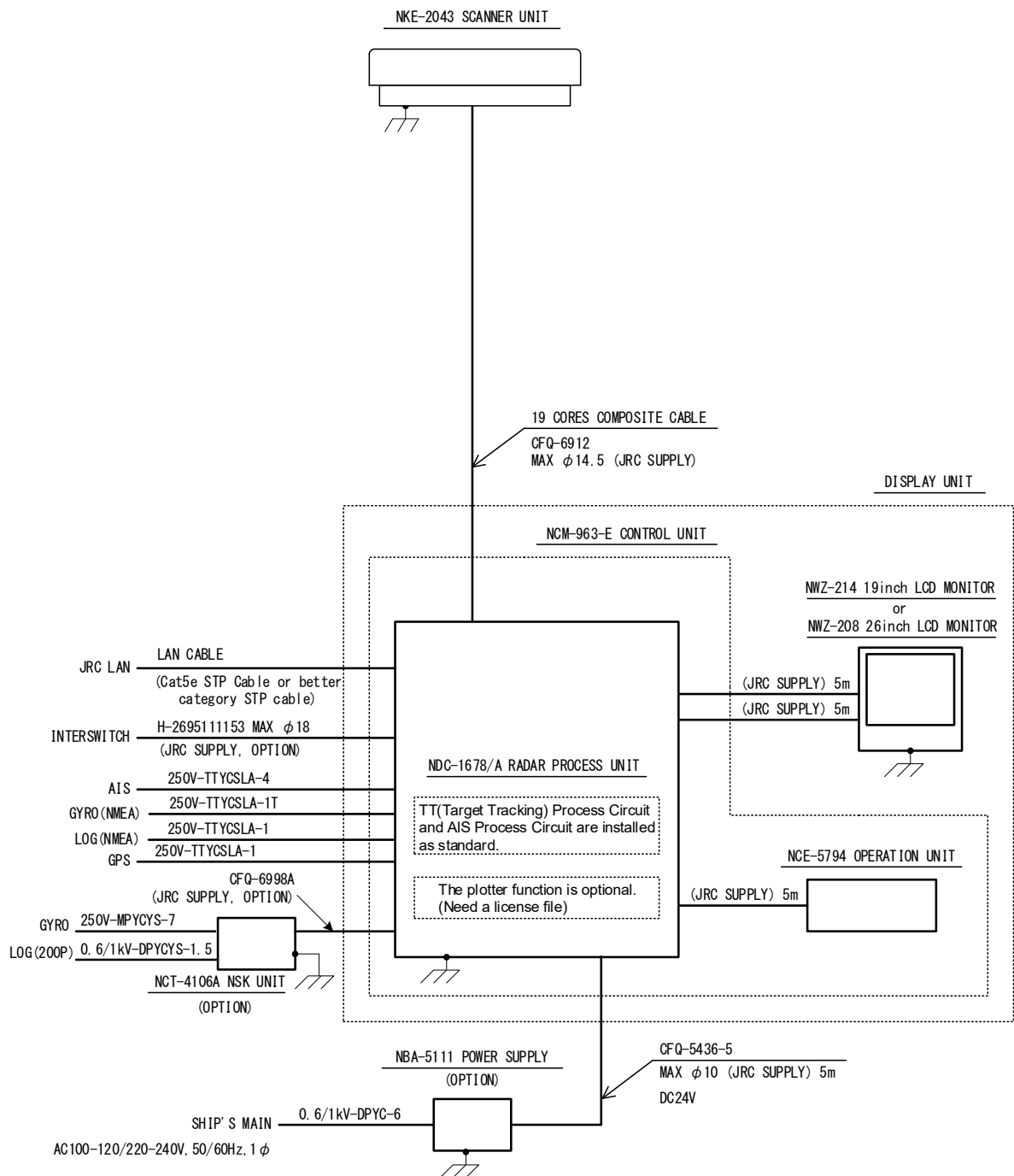

NOTE: Eliminating the interference on frequencies used for marine communications and navigation due to operation of the radar.

All cables of the radar are to be run away from the cables of radio equipment.

(Ex. Radiotelephone. Communications receiver and direction finder, etc.)

the radar should not be run parallel

General System Diagram of JMR-5404-X

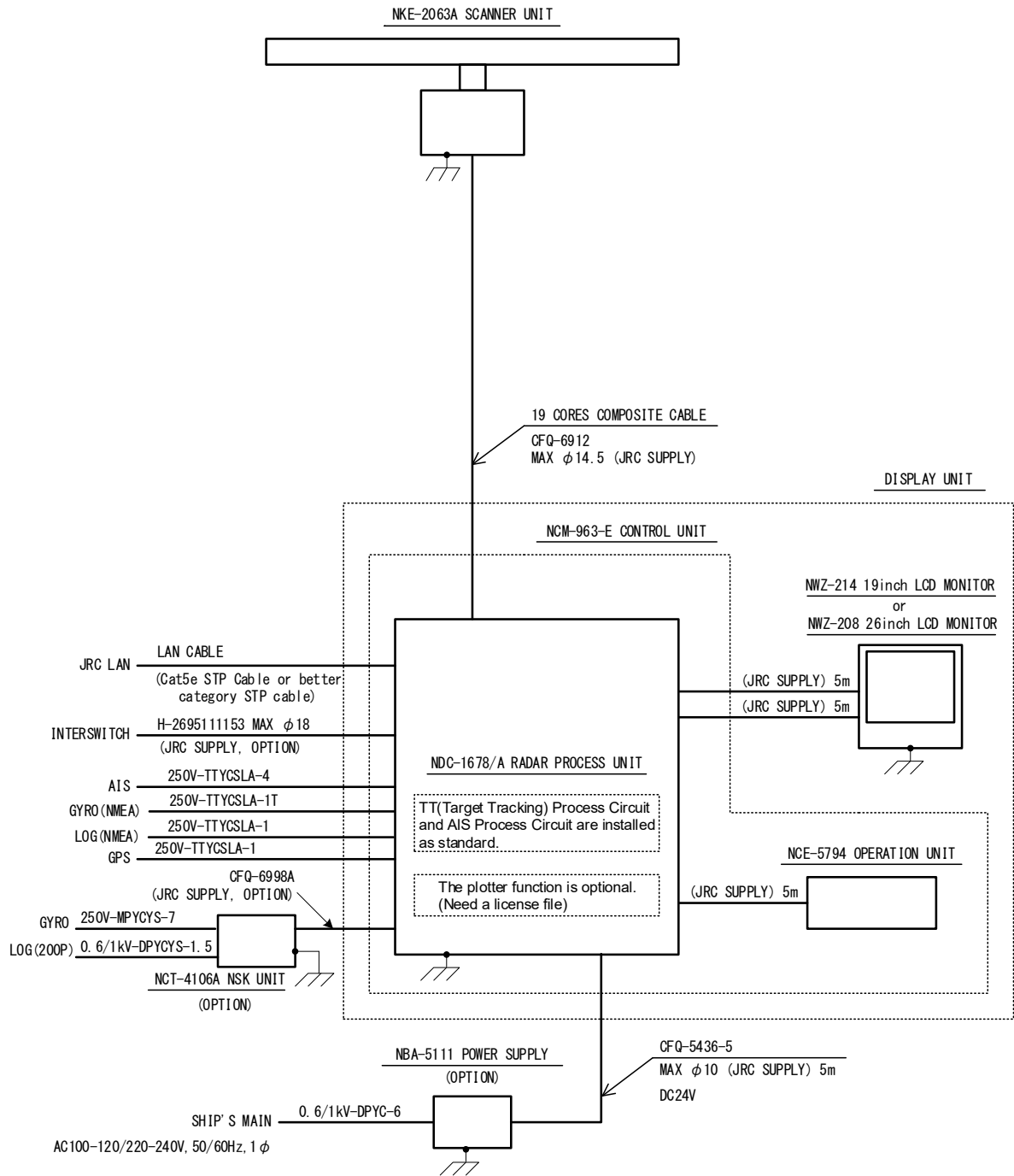

NOTE: Eliminating the interference on frequencies used for marine communications and navigation due to operation of the radar.
 All cables of the radar are to be run away from the cables of radio equipment.
 (Ex. Radiotelephone. Communications receiver and direction finder, etc.)
 Especially inter-wiring cables between scanner unit and display unit of the radar should not be run parallel with the cables of radio equipment.

General System Diagram of JMR-5406-X

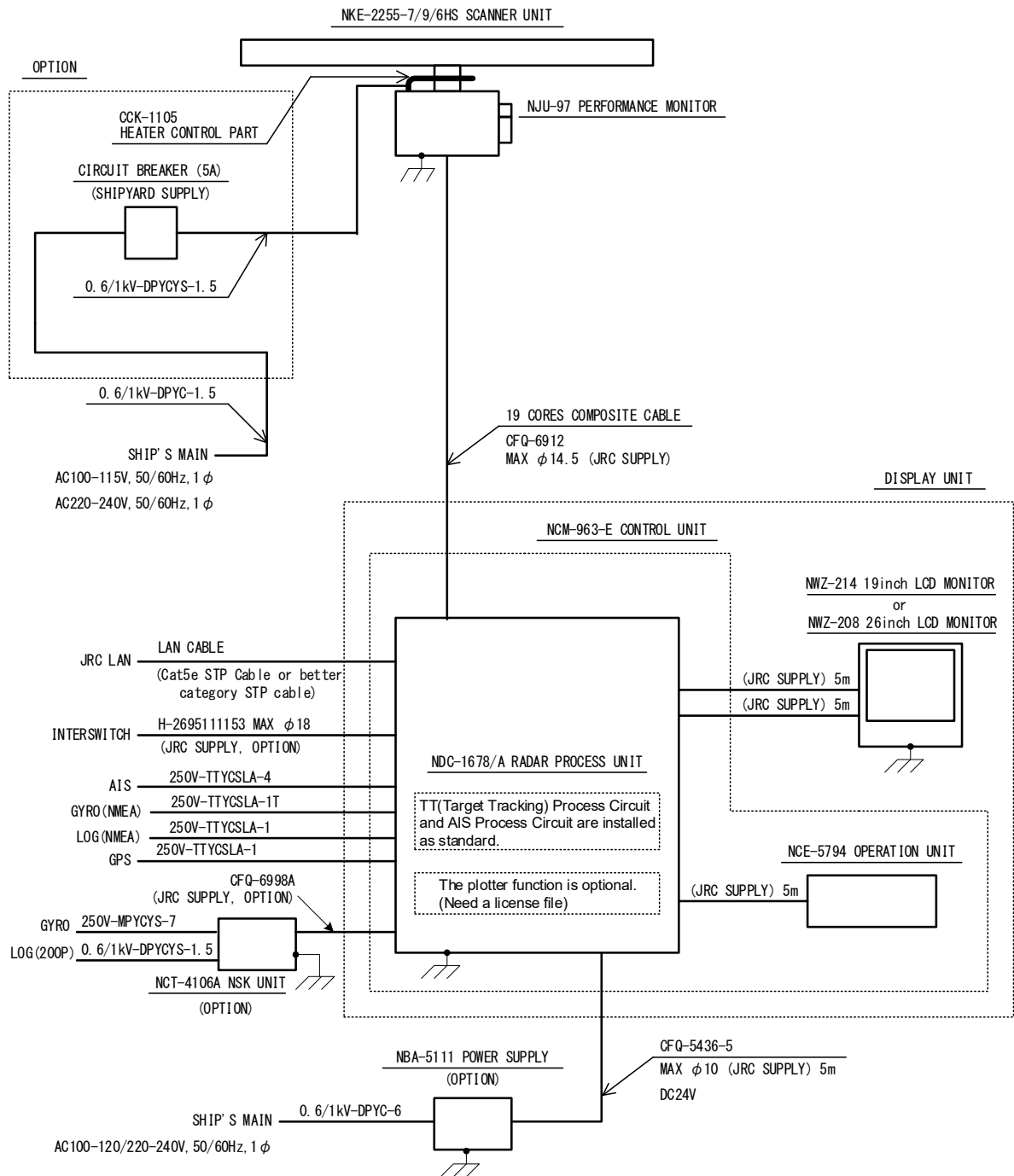

NOTE: Eliminating the interference on frequencies used for marine communications and navigation due to operation of the radar.
 All cables of the radar are to be run away from the cables of radio equipment.
 (Ex. Radiotelephone. Communications receiver and direction finder, etc.)
 Especially inter-wiring cables between scanner unit and display unit of the radar should not be run parallel with the cables of radio equipment.
 Performance monitor and NSK Unit must be fitted on ships compliant to IMO.

General System Diagram of JMR-5425-7X/9X/6XH

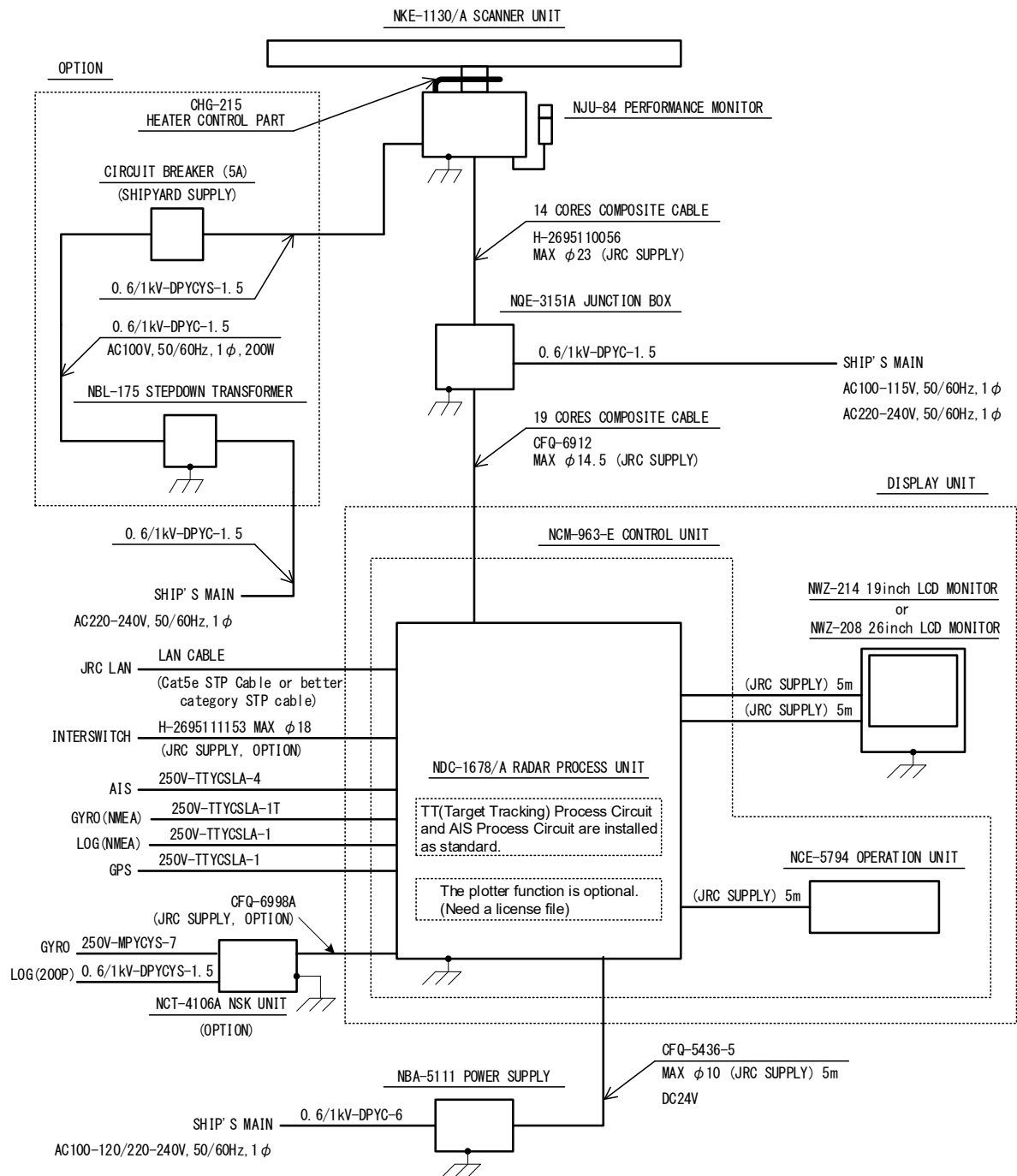

NOTE: Eliminating the interference on frequencies used for marine communications and navigation due to operation of the radar.
 All cables of the radar are to be run away from the cables of radio equipment.
 (Ex. Radiotelephone. Communications receiver and direction finder, etc.)
 Especially inter-wiring cables between scanner unit and display unit of the radar should not be run parallel with the cables of radio equipment.
 Performance monitor and NSK Unit must be fitted on ships compliant to IMO.

General System Diagram of JMR-5430-S

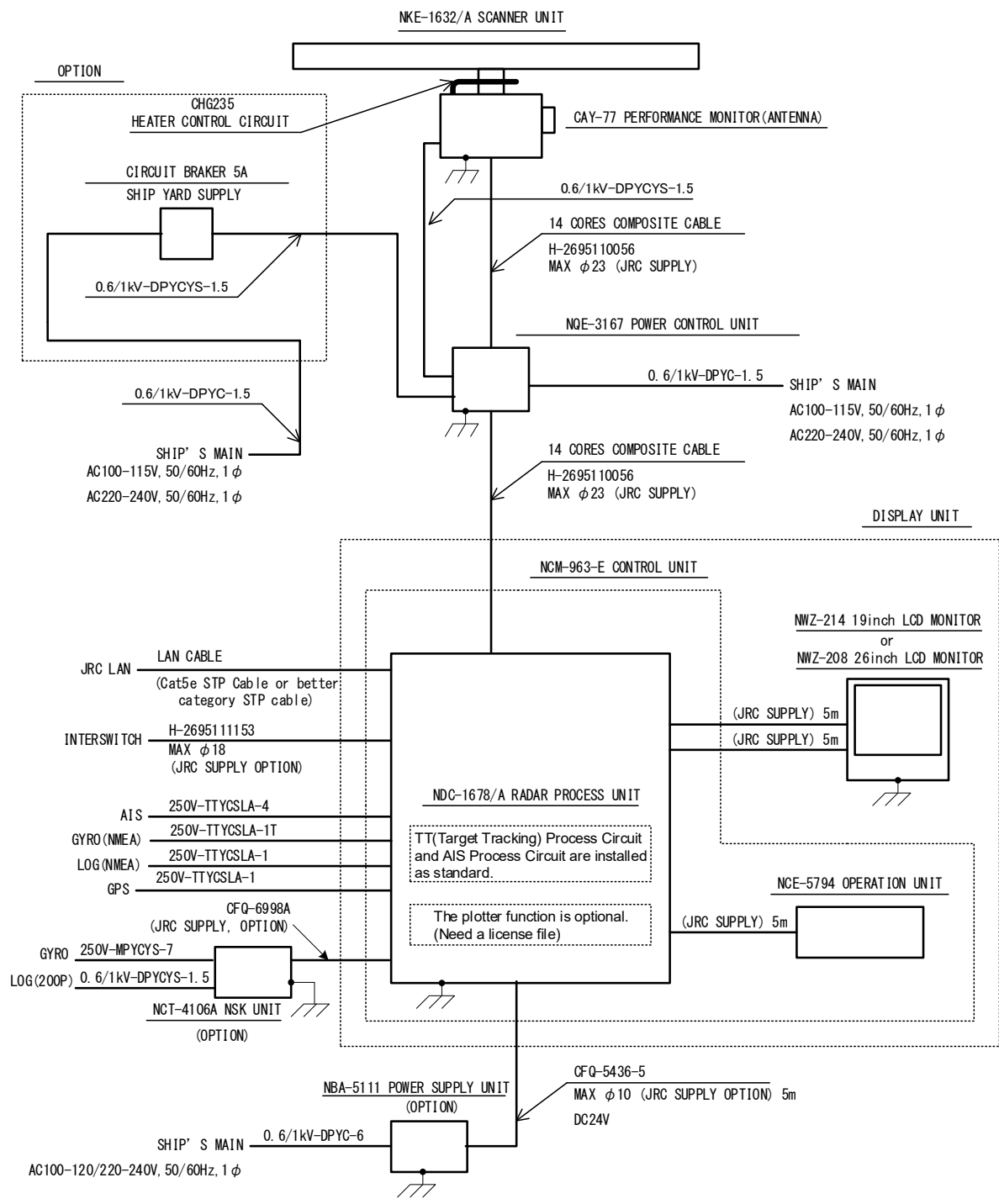

NOTE: Eliminating the interference on frequencies used for marine communications and navigation due to operation of the radar.
 All cables of the radar are to be run away from the cables of radio equipment.
 (Ex. Radiotelephone. Communications receiver and direction finder, etc.)
 Especially inter-wiring cables between scanner unit and display unit of the radar should not be run parallel with the cables of radio equipment.
 Performance monitor and NSK Unit must be fitted on ships compliant to IMO.

General System Diagram of JMR-5472-S

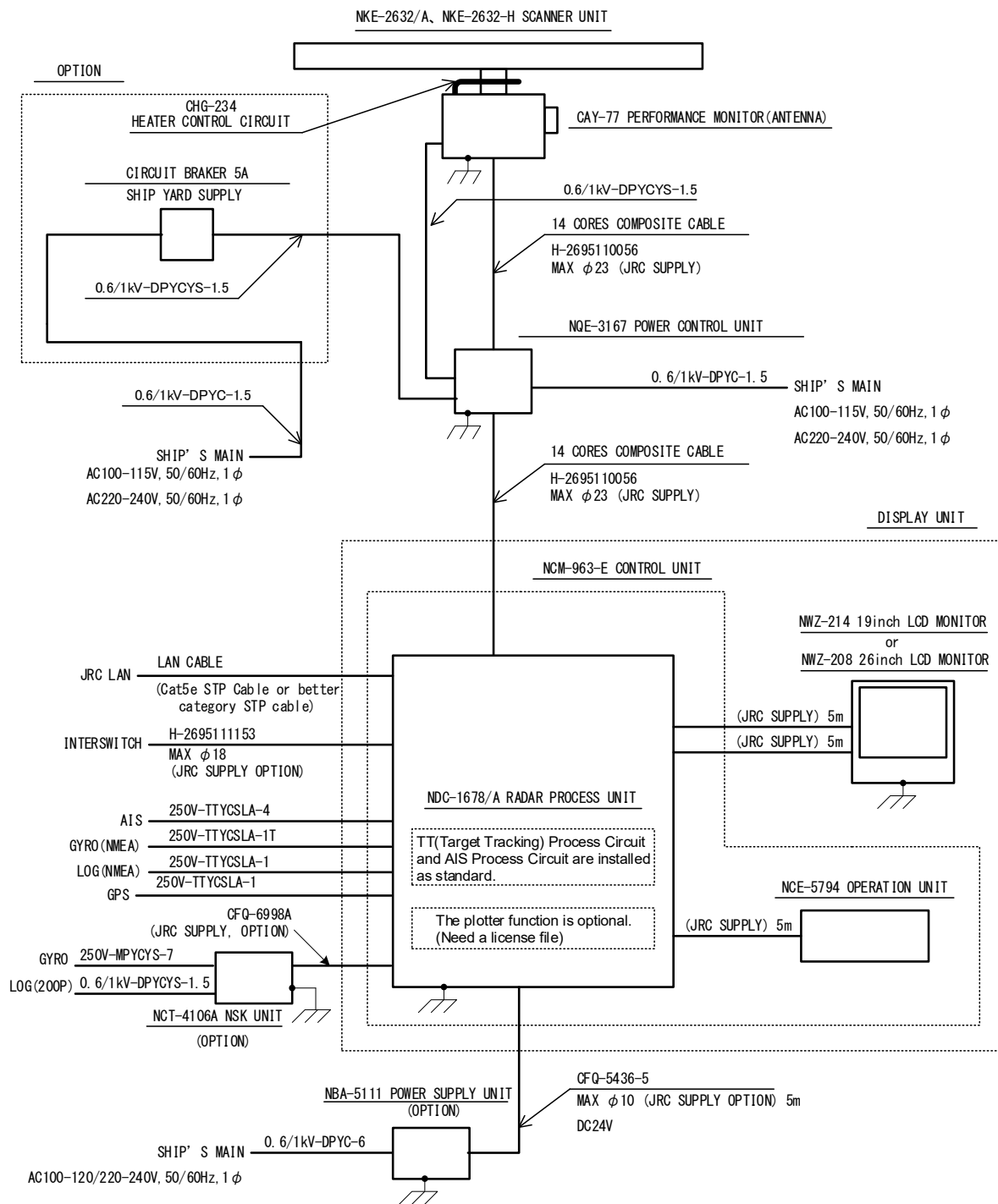

NOTE: Eliminating the interference on frequencies used for marine communications and navigation due to operation of the radar.
 All cables of the radar are to be run away from the cables of radio equipment.
 (Ex. Radiotelephone. Communications receiver and direction finder, etc.)
 Especially inter-wiring cables between scanner unit and display unit of the radar should not be run parallel with the cables of radio equipment.
 Performance monitor and NSK Unit must be fitted on ships compliant to IMO.

General System Diagram of JMR-5482-S/SH

Section 2 Name and Function of Each Unit

2.1 Name and Main Function of the Operation Unit

2.1.1 Standard operation unit

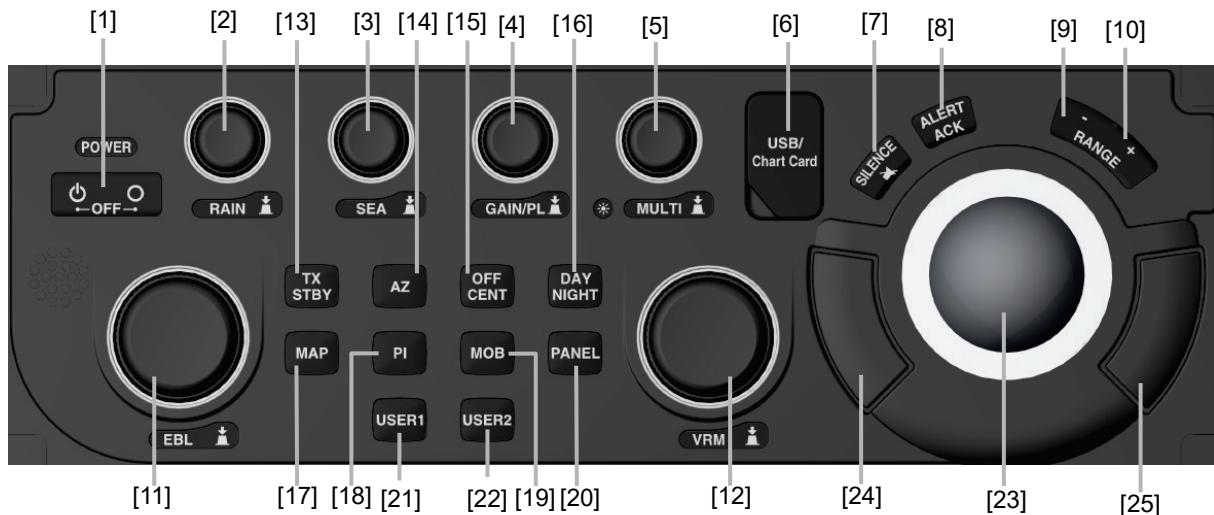

WARNING



When turning off the power supply, do not hold down the power button of the operation unit. Otherwise, a trouble may occur due to termination failure.

| No. | Name | Function outline |
|-----|--------------------------|---|
| 1 | Power supply button | Use this button to turn on and off this equipment. |
| 2 | [RAIN] dial | <ul style="list-style-type: none"> When this dial is turned, the level of rain/snow clutters on the radar image is adjusted. When this dial is pressed, the function mode is switched to manual/automatic. |
| 3 | [SEA] dial | <ul style="list-style-type: none"> When this dial is turned, the level of sea clutters on the radar image is adjusted. When this dial is pressed, the function mode is switched to manual/automatic. |
| 4 | [GAIN] dial | <ul style="list-style-type: none"> When this dial is turned, the gain of the radar image is adjusted. When this dial is pressed, the transmission pulse width is switched. |
| 5 | [MULTI] dial | <ul style="list-style-type: none"> Turn this dial to operate the function that is assigned to the [MULTI] dial such as the Display Brightness function. If the [MULTI] dial is held down, the Display Brightness function is assigned to the [MULTI] dial forcibly. |
| 6 | USB terminal | Connects a USB flash memory. |
| 7 | [SILENCE] key | Stops the alert buzzer. |
| 8 | [ALERT ACK] key | Acknowledging the alert. |
| 9 | [RANGE -] (zoom-in) key | <ul style="list-style-type: none"> This key contracts the observation range by one level. When this key is held pressed, setting will step continuously until released. |
| 10 | [RANGE +] (zoom-out) key | <ul style="list-style-type: none"> This key expands the observation range by one level. When this key is held pressed, setting will step continuously until released. |

| No. | Name | Function outline |
|-----|-----------------------------|--|
| 11 | [EBL] dial | When this dial is turned, control moves in the EBL (PI) direction with control right. This dial also moves the cursor horizontally (in cursor move mode). |
| 12 | [VRM] dial | When this dial is turned, control moves in the VRM (PI) direction with control right. This dial also moves the cursor vertically (in cursor move mode). |
| 13 | [TX STBY] key | When this dial is pressed, the radar transmission status is switched to Standby or Transmit. |
| 14 | [AZ] key | <ul style="list-style-type: none"> • This key switches AZ to On/Off. • When this key is held down, the "[AZ] Key Assignment" dialogue box appears. |
| 15 | [OFF CENT] (off centre) key | This key enables moving of the display position of own ship to any point. For the details, refer to "5.4.8 Moving own ship's display position (Off Centre)". |
| 16 | [DAY NIGHT] key | Switches the display colour on the screen over 5 levels according to the brightness on the bridge. |
| 17 | [MAP] (mode switching) key | When this key is pressed, the mode is switched to the RADAR mode or the Synthesis mode. |
| 18 | [PI] key | <ul style="list-style-type: none"> • Switches the PI operation/display to On/Off. For PI operation, refer to "4.6 Using Parallel Index Lines (PI)". • When this key is held down, the cursor mode is changed to the floating PI mode. |
| 19 | [MOB] key | <ul style="list-style-type: none"> • Displays the MOB symbol and the setting dialogue box in the own ship's position latitude/longitude. • When this key is held down, the MOB symbol and the setting dialogue box are cleared. |
| 20 | [PANEL] key | Whenever this key is pressed, the brightness of the panel on the operation unit is switched. |
| 21 | [USER1] key | <ul style="list-style-type: none"> • Executes the function that is assigned to the key. • When this key is held down, the setting dialogue box of the function that is assigned to the [USER1] key appears. |
| 22 | [USER2] key | <ul style="list-style-type: none"> • Executes the function that is assigned to the key. • When this key is held down, the setting dialogue box of the function that is assigned to the [USER2] key appears. |
| 23 | Track ball | Moves the cursor on the screen. Use the track ball to specify a position or to perform various settings. |
| 24 | Left button | <ul style="list-style-type: none"> • Use this button to select a function or determine the operation that is set. • The clicking of the left button once is referred to as "click" in this manual. • The clicking of the left button twice consecutively is referred to as "double click" in this manual. |
| 25 | Right button | <ul style="list-style-type: none"> • Use this button to select a function or perform setting operation. • The clicking of the right button is referred to as "right click" in this manual. |

2.1.2 Display unit

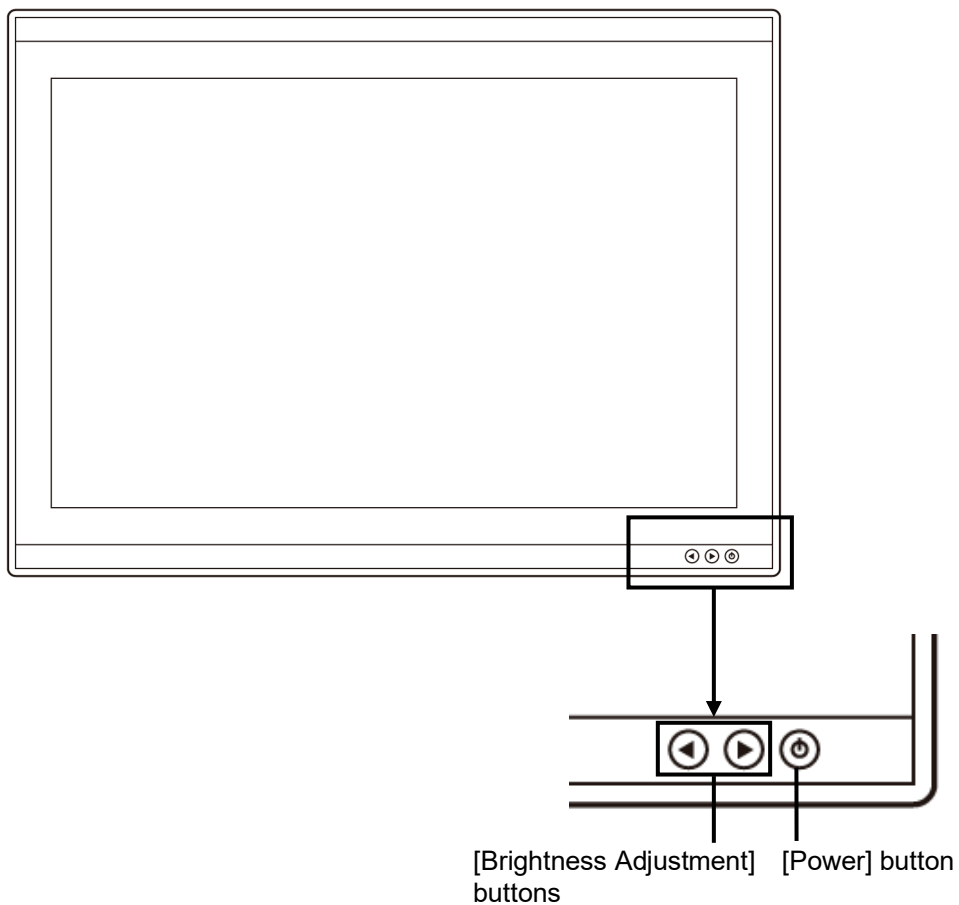

[Power] button

When the Power button is pressed while the power of the display unit is turned off, the power is turned on.

To turn off the power of the display unit, press the Power button for 5 seconds or longer.

[Brightness Adjustment] buttons

These buttons are used to adjust the brightness of the screen.

The screen increases brightness by pressing the ► button.

The screen decreases brightness by pressing the ◀ button.

Memo

Adjust the brightness of the screen to the extent under which the observation of the RADAR screen is enabled easily and, at the same time, the screen is not too bright, taking into account the brightness of the surroundings.

2.2 Names and Main Functions of the Mode Screen Common Sections

This section describes the name of each section of the mode screen and the main functions.

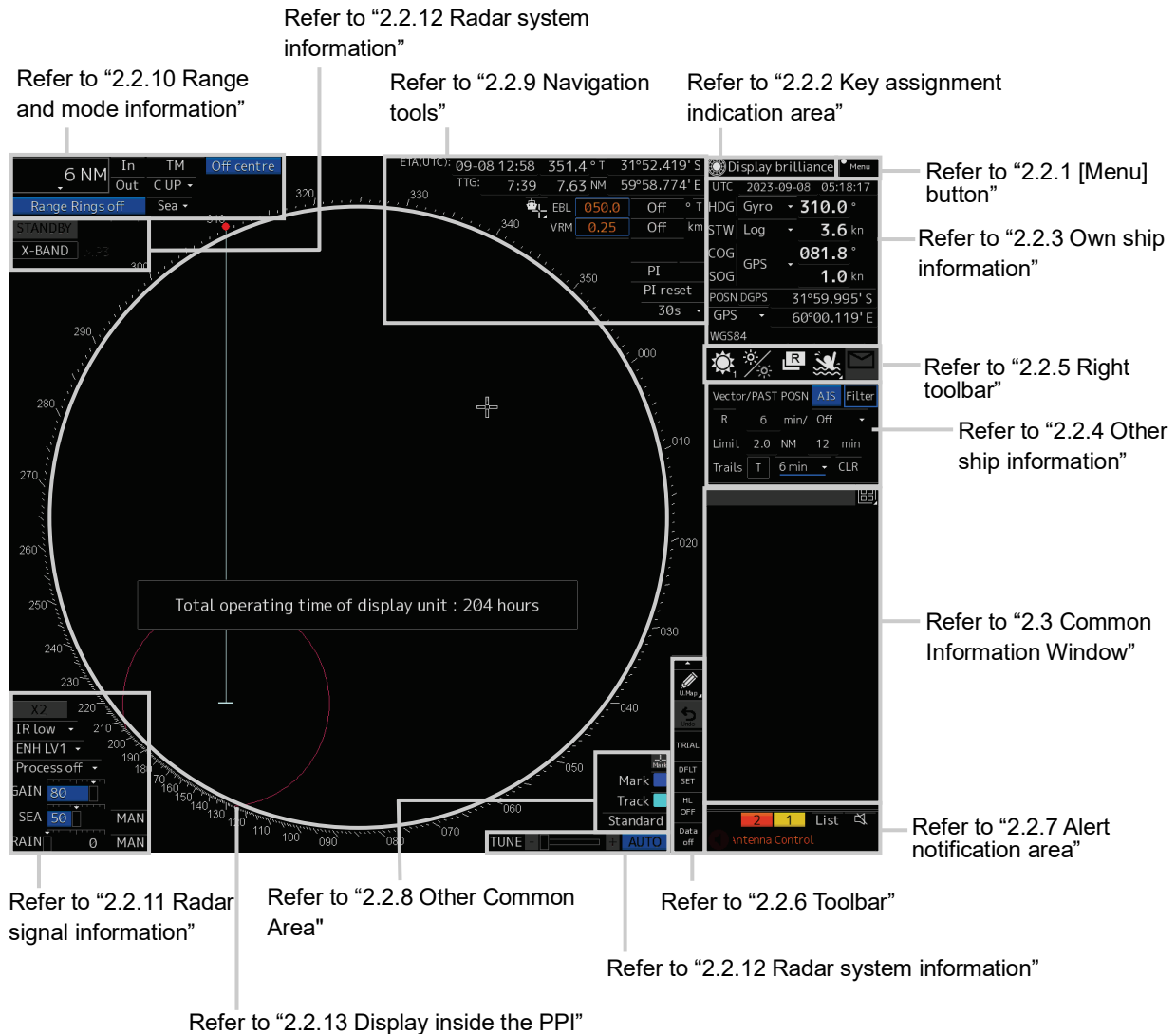

2.2.1 [Menu] button

When the [Menu] button is clicked on, the Top menu is displayed.

For the details of the menu, refer to "3.4 Basic Menu Operations".

Memo

This equipment is operating normally when the [Menu] button is moving in animation mode.

When this equipment is set to a freeze state, the Menu button stops and does not move. In this case, turn off the power once and turn it on again.



2.2.2 Key assignment indication area

When the [MULTI] dial is turned, the assigned functions are operated.



For the function assignment, refer to "3.18 [Multi] dial".

2.2.3 Own ship information

| | |
|--|---|
|  WARNING | |
|  | Do not use the offset function during navigation. If the equipment is used with the offset value entered as the own ship position (deviated from the actual position), accidents may result. |

This window displays the own ship's information.

Memo

- When using 1-axis log, heading speed component can be detected, but transverse speed component cannot be detected. Then leeway effect (component drifted by wind) cannot be detected.
- When using 2-axes log, its accuracy in shallow waters may be deteriorated, and its speed in deep sea areas may be unable to be detected.
- When using a GPS, COG accuracy is less than $\pm 3^\circ$ at speed: from 1kn to 17kn, and is less than $\pm 1^\circ$ at speed: more than 17kn.



UTC/Local date and time

This button displays the current date and time.

- When the button is clicked on, the time can be switched to the UTC time display or Local time display.
- Set the time format by selecting [Maintenance] - [Date/Time/Time Zone]-[Display Style] on the menu.

For the details, refer to "15.1.1 Setting Date/Time/Time Zone".

Sensor information

Various sensor information items are displayed.

[Sensor types]

| Sensor name | Contents |
|-------------|---|
| HDG | Displays the value indicated by the ship's heading sensor. |
| STW | Displays the value indicated by the speed through water sensor. |
| COG/SOG | Displays the value indicated by the speed over the ground sensor. |

[Sensor value background colours]

Each background colour represents the following meaning.

Normal colour: Normal sensor value

Yellow: The reliability of the sensor value is deteriorating.

Yellowish orange: The sensor value is abnormal.

[Switching the sensor source]



Select the sensor source in the [Source] combo box. The following sensor sources can be selected.

When [Menu] is selected, the [Sensor Selection/Status] dialogue is displayed.

| Sensor name | Sensor source |
|-------------|---|
| HDG | MAN (Manual), Gyro, Gyro 1 ^{*1*} , Gyro 2 ^{*1*} , MAG (MAG Compass) ^{*4} , G/C (GPS Compass) |
| STW | MAN (Manual), Log, Log 1 ^{*2*} , Log 2 ^{*2*} |
| COG | Log, Log 1 ^{*2*} , Log 2 ^{*2*} , GPSx ^{*3} , TGT |
| SOG | |

*1: Only when there are two Gyros.

*2: Only when there are two Logs.

*3: When two or more GPS units are present, "x" indicates the unit number.

*4: When the gyro compass system equipped with the automatic switching function is used, the display of the sensor source changes automatically according to the switching condition.

*5: When 1AX is installed in Log, Log cannot be selected from the sensor source.

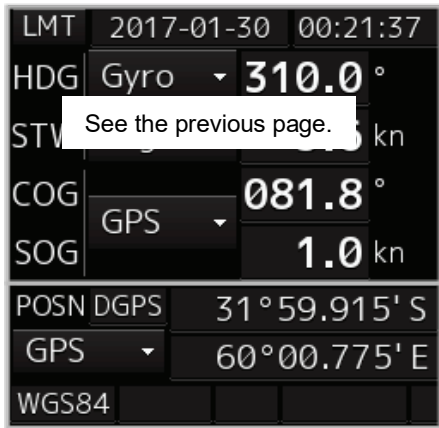

POSN

Displays the POSN information.

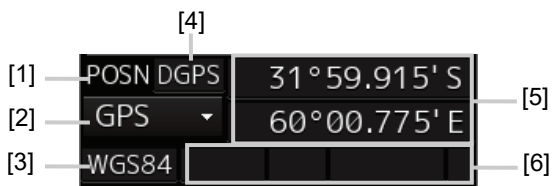

[1] The data name of POSN is displayed.

[2] The sensor source of POSN is displayed.

Select a sensor source in the [Source] combo box. Any of the following sensor sources can be selected. When [Menu] is selected, the [Sensor Selection/Status] dialogue is displayed.

| Data name | Sensor source |
|-----------|---------------|
| POSN | GPSx* |

*: When two or more GPS units are present, "x" indicates the unit number.

[3] The Geodetic Positioning System of POSN is displayed.

[4] Positioning precision display of POSN

When the positioning precision is differential positioning, "DGPS" is displayed. No information is displayed in the case of GPS single positioning.

[5] POSN (CCRP) position

The CCRP position indicated by the primary positioning sensor is displayed.

[6] Badge display area



Offset : This badge is displayed, when offset is set for own ship's position.

AFT : This badge is displayed, when AFT Operation is enabled.

EBL/VRM : This badge is displayed, when EBL/VRM cursor mode is enabled.

V : This badge is displayed, when GPS Buoy mode is enabled.

2.2.4 Other ship information

The diagram shows a control panel for AIS (Automatic Identification System) with several buttons and input boxes. The main panel includes a 'Vector/Past POSN' section with buttons for 'R', '6 min', and 'Off'. Below this is a 'Limit' section with '2.0 NM' and '12 min'. The 'Trails' section has 'T', '3 min', and 'CLR' buttons. A secondary 'Trails' section is shown below with callouts [1] and [3].

[AIS] button
This button sets the AIS function to On/Off.
On: Off:

Memo
When AIS is set to Off, alerts relating to AIS are also no longer displayed.

[Filter] button
When the cursor is placed on this button while AIS is On, the AIS Filter status is displayed.

The following status is displayed.
Filter type

- Filter shape: For Sector, the status is displayed with Start Angle and End Angle, and for Ring, the status is displayed with Distance.
- Filtering mode: Priority or Display

[1] Trail True/Relative switching button
This button switches the trail mode to True or Relative.
When True is set, "T" is displayed on the button and when Relative is set, "R" is displayed on the button.

[2] Trail length switching combo box
This button switches the trail length.
For the details, refer to "5.4.9 Displaying other ship's trails (Trails)".

[3] [CLR] (Trail Clear) button
When this button is clicked on, the trail is cleared.
For the details, refer to "5.4.9 Displaying other ship's trails (Trails)".

[1] CPA limit value input box
Input a CPA limit value. For the details, refer to "6.4.3 Setting collision decision criteria".

[2] TCPA limit value input box
Input a TCPA limit value. For the details, refer to "6.4.3 Setting collision decision criteria".

[1] Vector past position True/Relative switching button
This button switches the vector past position to True or Relative.
For the details, refer to "6.4.2.2 Setting vector mode".

[2] Vector length input box
Enter a vector length.
For the details, refer to "6.4.2.4 Setting the vector length".

[3] Past position interval switching combo box
For the details, refer to "6.8.1 Setting the past position".

2.2.5 Right toolbar

The functions of the buttons of the right toolbar are as follows.

Day/Night button

The display colour on the screen can be switched to 5 levels according to the brightness on the bridge.

For the details, refer to "3.8 Switching the Day/Night Mode".

Message notification button

When this button is clicked on, the dialogue relating to the latest notification message is displayed among the AIS message tray and NAVTEX reception information.

For the message dialogue box of each of the information received, refer to "2.3.2 Information reference windows".

The total number of unread messages is displayed on the badge.

Display and Panel Brightness button

The brightness of the screen is switched within the range from 0 to 100 and the brightness of the operation unit in 5 levels from 0 to 4.

For the details, refer to "3.9 Adjusting the Brightness of the Screen and Operation Unit".

MOB (Man Over Board) button

When a person falls overboard, use this button to mark the own ship's position when the button is clicked on, so as not to lose the sight of the position.

For the details, refer to "3.12 MOB (Man Over Board)".



Mode switching button

By clicking on this button, the mode can be switched. The mode is switched repeatedly as [Radar mode]→[Synthesis mode]→[Radar mode].

For the details, refer to "3.10 Switching Mode".

2.2.6 Toolbar

The function of each button on the toolbar is described below.

Out of the buttons on the toolbar, some are shown and the others are hidden in normal cases.

Click on the Disclosure button to switch the display.

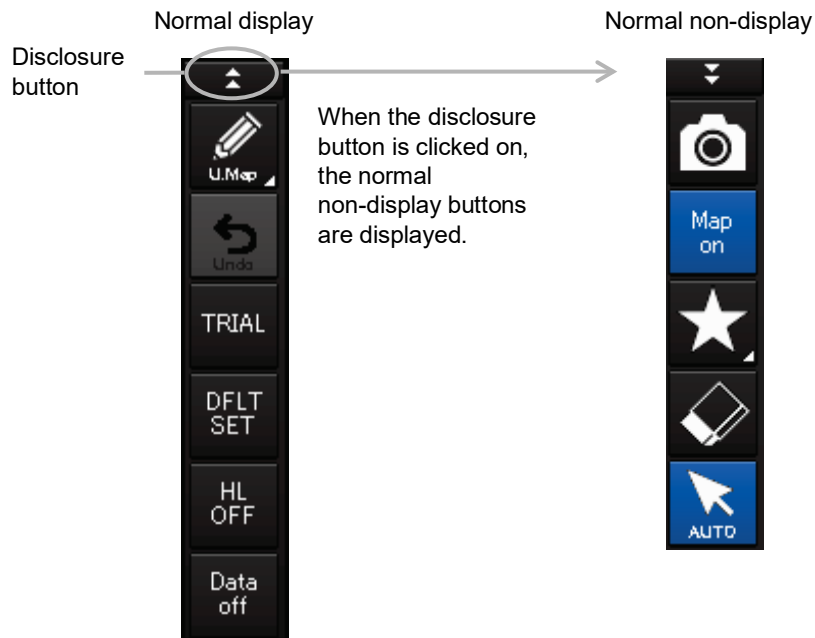

Refer to the next page for the name and function of each button.

2.2.6.1 Buttons that are normally displayed

PEN (Write tool) button

When this button is clicked on at user map creation, the mode is changed to the user map operation mode.
The mode name will be indicated on the button.



Example: [U.Map] (User Map) mode

[U. Map] (User Map) mode

Clicking on the button when it indicates [U. Map] displays the drawing toolbar for user maps.

[HL Off] button

When this button is clicked on, the Heading Line becomes hidden.

For the details of the Heading Line, refer to "11.1.1 Setting up the Display of Own Ship Symbol".



[Undo] button

Clicking on this button cancels the previous operation performed.

- In user map creation mode
- Own Track
- Target Track

[TRIAL] button

Clicking on this button [Trial MVR] dialog appears.

For the details, refer to "6.13 Trial Manoeuvring".

[Def. Set] (Settings at shipment) button

When this button is clicked on, the screen display return from the personal setting information to the settings at shipment.

The function is the same as that of the [Default display configurations] button in [Preference] on the [Settings] dialogue box.

For the details, refer to "13.25 Setting Preference Information".

[Data Off] button

When this button is clicked on, only the main information is displayed from the screen display and other information is hidden.

The following information items are displayed:

- Echo/trail
- Cursor

2.2.6.2 Buttons that are normally hidden

[Screen Capture] button

When this button is clicked on, the screen that is currently displayed is captured.

For the details, refer to "3.16 Saving the Screen that is Currently Displayed".

[Eraser tool] button

When this button is clicked on, the User Map Erase mode is set, enabling continuous erasing.



[Map On/Off] button

Clicking on this button switches to show or hide the chart.

[Favourite] button

When this button is clicked on, a list of the functions that have been registered as Favourites is displayed.

For the details, refer to "3.17 Favourite Registering Function".

[AUTO] (Cursor mode selection) button

When this button is clicked on, the cursor mode is switched to the AUTO mode.

For the details of the cursor mode, refer to "3.15 Cursor AUTO Mode".

2.2.7 Alert notification area

When an alert occurs, the alert status, the contents of the alert and the occurrence count are displayed in the alert notification area.

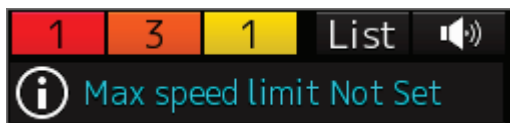

For the details, refer to "3.7 Confirming and Acknowledging an Alert".

2.2.8 Other Common Area

SD Card Removal button

Displayed when a C-MAP MAX SD card is inserted.
To remove the SD card, click on this button, and remove the card after the icon is set to a removal enabled status.
The statuses of the icon are shown in the table on the right side.

| Icon | Status |
|------|--|
| | Enabled. When this icon is clicked on the removal of the card is requested. |
| | Disabled. The removal of the card is disabled while card removal is being requested. |
| | Removal enabled. The card removal request is successful, and the SD card can be removed. |

C-MAP MAX logo

Displayed when a C-MAP MAX chart is displayed.

User Map colour

Displays the User Map Colour that is common among Mark/Line/Text and the Own Track Colour.
When the colour icon is clicked on, a colour selection balloon is displayed, enabling the change of the colour.

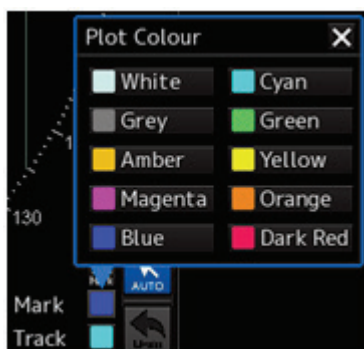

Reversal key

Switches the marking position at mark input. The switching operation repeats as [Own ship's position] → [Cursor position] → [Own ship's position].
When the input position is switched, the icon changes correspondingly at the same time.

| Icon | Mark input position |
|------|----------------------------------|
| | Input in the own ship's position |
| | Input in the cursor position |

Observation scene selection button

Sets an observation scene.

For the details, refer to "5.3.7 Adjusting to optimum image (Selection of observation scenes)".

2.2.9 Navigation tools

The tools that are used for measurement are displayed.

Cursor information display area

When the cursor is set on a target, the cursor information is displayed.
For the details, refer to "4.3 Using the Cross-hair Cursor".

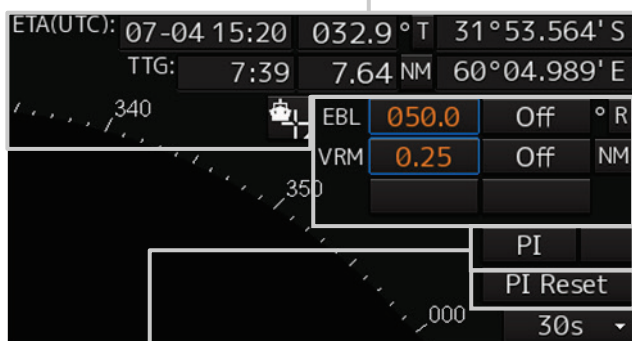

EBL/VRM operation button area

Use this button to operate EBL/VRM.

For the details, refer to "4.5.1 Measuring a range and a bearing with EBL and VRM"

[PI Reset] button

Effective only in the All mode that sets all the parallel index lines concurrently.
When this button is clicked on, all the parallel index lines are set parallel to the heading of own ship.
For the details of the All mode, refer to "4.6.3 Setting all the parallel index lines concurrently (All mode)".

[PI] button

Use this button to operate the parallel index line cursor.

For the details, refer to "4.6 Using Parallel Index Lines (PI)".

2.2.10 Range and mode information

Range scale combo box

Set the observation range.

For the details, refer to "5.3.2 Changing the observation range".

[In] (Expand) button

Whenever this button is clicked on, the screen image is zoomed in by one level from the current range scale.
When this button is held down, the image is zoomed in continuously.

Motion mode combo box

Set the motion mode.

For the details, refer to "5.4.6 Setting a motion mode".



[Out] (Reduce) button

Whenever this button is clicked on, the screen image is zoomed out by one level from the current range scale.
When this button is held down, the image is zoomed out continuously.

[Off Centre] button

Use this button to set Off Centre to On/Off for the display position of the own ship's position (CCRP).

For the details, refer to "5.4.8 Moving own ship's display position (Off Centre)".

Bearing mode combo box

Set the bearing mode.

For the details, refer to "5.4.5 Setting the azimuth mode".

Range rings display button

Use this button to switch range rings to On/Off.

For the details, refer to "4.4 Using the Range Rings".

Stabilisation mode combo box

Set the stabilisation mode.

For the details, refer to "5.4.7 Setting the stabilisation mode".

2.2.11 Radar signal information

[×2] (Double scale display) button When this button is clicked on, the double scale zoom function is switched to On/Off.

For the details, refer to "5.4.10 Doubling the size of radar image".

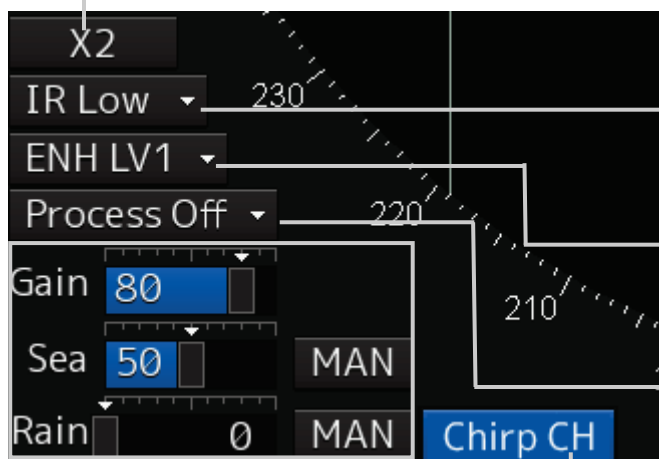

[IR] combo box

This setting is enabled to set a radar interference rejection function from the list
For the details, refer to "5.4.1 Interference Rejection (IR Function)".

[Target Enhance] combo box

This setting is enabled to set a target enhancement function from the list
For the details, refer to "5.4.3 Enhancing targets".

[Echo Process] combo box

This setting is enabled to set a video processing function from the list
For the details, refer to "5.4.4 Using video processing (Echo Process)".

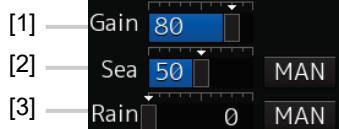

[1] Reception sensitivity adjustment

The reception sensitivity can be adjusted.
For the details, refer to "5.3.4 Adjusting gain".

[2] Sea clutter adjustment

The sea clutter rejection level can be adjusted.

For the details, refer to "5.3.5 Rejecting sea clutter (Sea)".

[3] Rain and snow clutter adjustment

The rain and snow clutter rejection level can be adjusted.

For the details, refer to "5.3.6 Rejecting rain/snow clutter".

[Chirp Channel] button

This button sets the Chirp Channel function to On/Off.
*The Chirp Channel function can be set only when a small solid -state radar antenna is connected. By changing the transmission central frequency (channel) of Q0N (Chirp wave: Frequency modulation pulse) that is used for pulse compression, interferences can be controlled.

2.2.12 Radar system information

On this window, verify, adjust, and set a signal tuning status.

The display varies according to the radar antenna type.

Standby/transmission switching button

Whenever this button is clicked on, the mode is switched to "Standby" or "Transmit". When the power for this equipment is turned on, "Preheat" is displayed on this button.

For the display change at power ON, refer to Step 3 in the section "5.2.1 Powering on and starting"

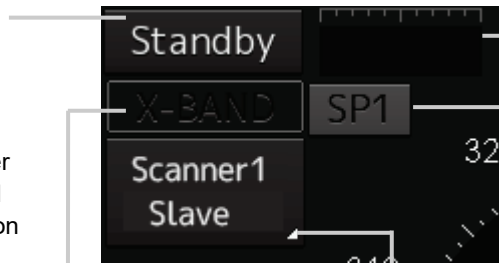

Tuning status confirmation bar display

Displays the tuning indication value from the transceiver. This bar is not displayed when the antenna is a solid-state radar.

Transmission pulse length switching button

This button switches a transmission pulse length. For the details, refer to "5.4.2 Changing the transmitter pulse length".

Transmission band display

This button displays the transmission band that is currently used (X-Band or S-Band).

Control status and control antenna display at inter-switch connection

When this button is clicked on, the interswitch switching window is displayed.

For the details of the inter-switch, refer to "Appendix C Setting the Interswitch".

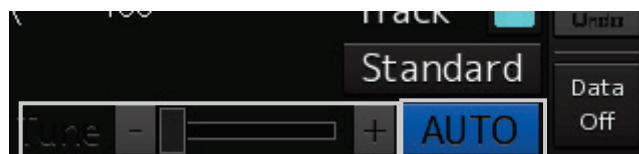

Fine tuning adjustment slider

This button checks the tuning status and slightly adjusts.

For the details, refer to "5.3.3 Adjusting tune".

Tuning mode switching button

Switches the tuning mode between AUTO (automatic) and MAN (manual).

2.2.13 Display inside the PPI

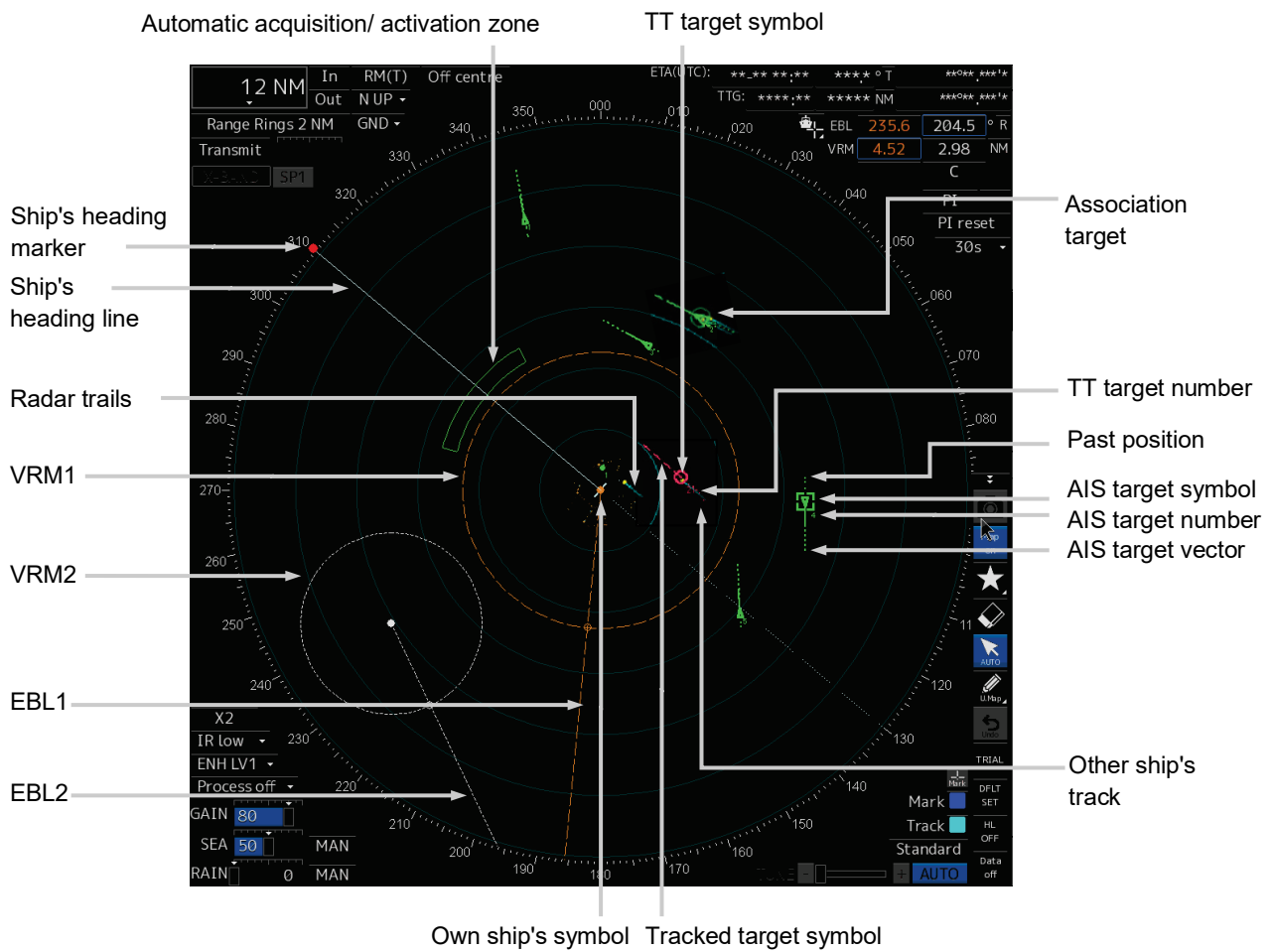

2.3 Common Information Window

The information that is displayed on the Common Information Window is classified into two major types: information monitoring and information referencing.

An **information monitoring** window is used together with radar PPI and a chart, and the information includes TT/AIS value information, conning blocks, etc.

- The information monitoring windows are displayed at the bottom right corner of the screen as the fixed position.

The **information reference** is the window that is temporarily referenced according to the user request and the information includes AIS messages, alert information, and own ship AIS information.

- The information reference window can be switched to either the standard window display or the extended window display. For the details of the switching between the standard window and the extended window, refer to "2.3.2.1 Switching between a standard window and an extended window".

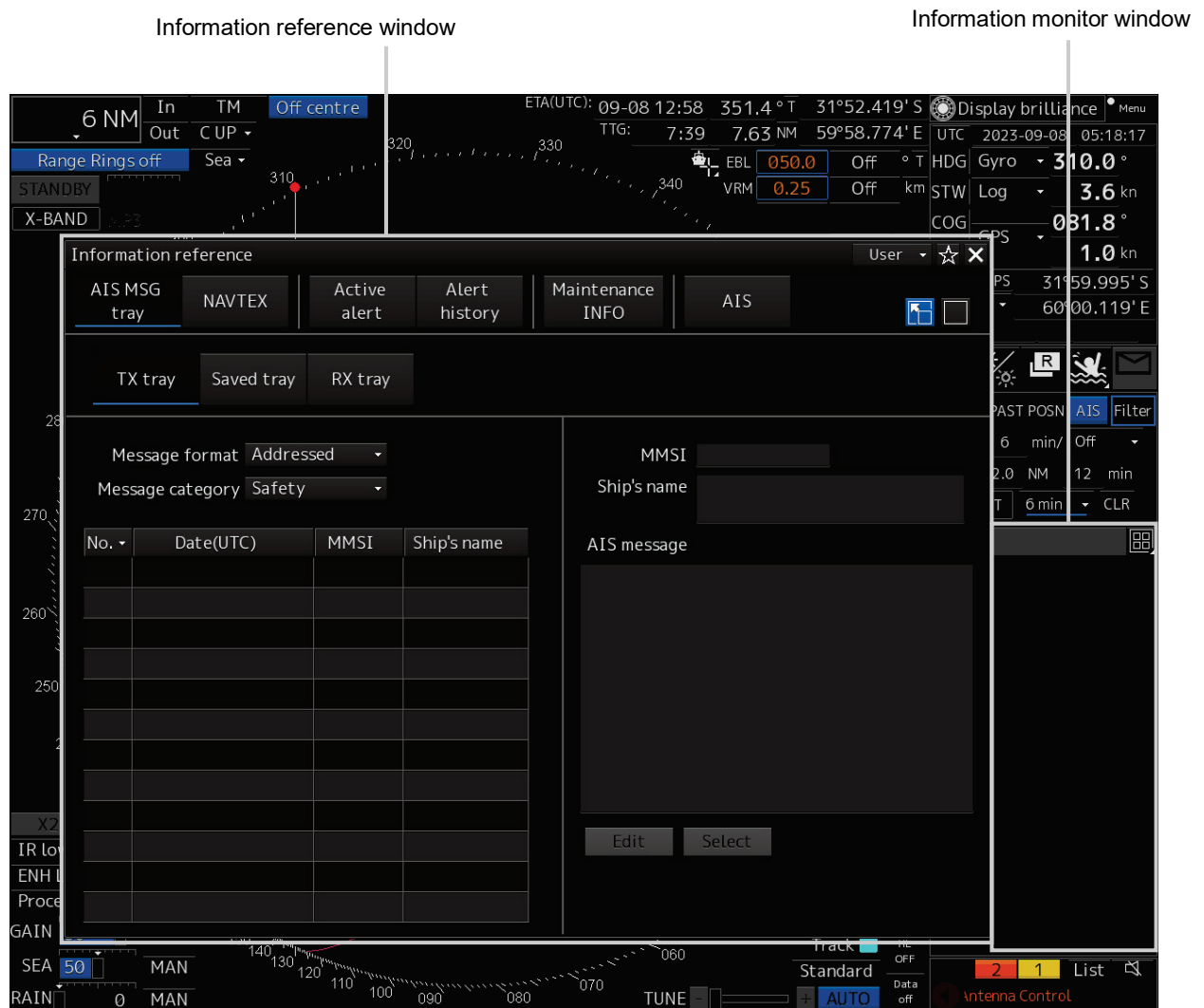

Display example under RADAR screen

2.3.1 Information monitor windows

Information monitoring related windows is as follows.

| Item | Contents | Related section |
|-----------------|--|----------------------------|
| Target INFO | TT/AIS movement information | 2.3.1.1 Target INFO |
| TT List | TT target risk sequence list | 2.3.1.2 TT List |
| AIS List | AIS target risk sequence list | 2.3.1.3 AIS List |
| AIS Detail INFO | Detail information relating one AIS target | 2.3.1.4 AIS Detail INFO |
| 2nd PPI | Radar 2nd PPI Displayed for a 26-inch screen. | 2.3.1.5 2nd PPI |
| Current/Wind | Wind speed and current information | 2.3.1.6 Wind/Current Block |
| Conning | Conning | 2.3.1.7 Conning |

2.3.1.1 Target INFO

Target INFO is the display monitor window that displays movement information of TT/AIS.

In Target INFO, TT information, AIS information, and AIS extended information are displayed.



TT information

The following information items are displayed.

| |
|--|
| Memo Some items may not be displayed due to the equipment setting differences. |
|--|

| Displayed information | Explanation |
|-----------------------|---|
| TT ID | Displays the identification number (1 to 30) of a TT target. *The maximum number of TT ID numbers that can be displayed is 100 when options are available. |
| Ship's Name | Displays the ship's name. When [Ship's Name] is selected after selecting [View] - [Target] - [TT Target ID], the ship's name is displayed instead of TT ID. |
| BRG | Displays the bearing of a TT target. When [▼] that is shown next to the bearing is pressed, a TT cancellation menu is displayed, and when the item is selected, the specified TT is cancelled. |
| Range | Displays the distance to a TT target. |
| COG or CTW | Displays the course of a TT target. Displayed as "COG" in the course over the ground mode and "CTW" in the course through the water mode. |
| SOG or STW | Displays the ship speed of a TT target. Displayed as "SOG" in the speed over the ground mode and "STW" in the speed through the water mode. |
| CPA | Displays the distance of the closest point of approach to the TT target. |
| TCPA | Displays the arrival time of the closest point of approach to the TT target. |
| BCR | Displays the bow crossing range of a TT target. |
| BCT | Displays the bow crossing time of a TT target. |

AIS information

- AIS information of the target is displayed.
- When the  /  (AIS standard/extension switching) button is clicked on, the display is switched between the standard display and the extended display.
- The following information items are displayed.

| Displayed information | Explanation |
|-----------------------------|--|
| AIS ID | Displays an AIS target ID numbers (1 to 180). *The maximum number of AIS ID numbers that can be displayed is 1000 when options are available. When [▼] that is provided next to AIS ID is pressed, an AIS pause menu is displayed, and when an item is selected, the specified AIS is set to pause. |
| [▼] button | When [▼] that is provided next to AIS ID is pressed, a menu is displayed. Deactivate AIS ID xx : When this item is selected, the specified AIS is set to pause. Show Registry of Ship : When this item is selected, the display is switched to registry of ship from [Call Sign] and [MMSI]. Hide Registry of Ship : When this item is selected, the display is switched to [Call Sign] and [MMSI] from registry of ship. |
| Name | Displays the ship name of an AIS target. |
| Call Sign | Displays a call sign. |
| MMSI | Displays a nine-digit identification number for a ship/ground station equipped with a DSC communication device. |
| COG or CTW | Displays the course of the AIS target. In Course Over the Ground mode, COG is displayed and in Course Through the Water, CTW is displayed. |
| SOG or STW | Displays the ship speed of an AIS target. Displayed as "SOG" in the speed over the ground mode and "STW" in the speed through the water mode. |
| CPA | Displays the closest approach distance to an AIS target. |
| TCPA | Displays the time to reach the closest approach point to an AIS target. |
| BRG* | Displays the bearing of an AIS target. |
| Range* | Displays the distance to an AIS target. |
| Heading* | Displays the heading of an AIS target. |
| ROT* | Displays the turning speed of an AIS target. |
| POSN and Position Accuracy* | Displays the position of an AIS target and position-fix accuracy. When the position-fix accuracy is low, [>10m] is displayed. When the position-fix accuracy is high, [<10m] is displayed. |
| Destination* | Displays the destination of an AIS target. |
| Navigation Status* | Displays the navigation conditions of an AIS target. For the details, refer to "Navigation Status" of the table in "2.3.1.4 AIS Detail INFO". |

*: Extended display only

AIS SART information

AIS SART information is displayed by using an extended display.

Unlike the AIS information extended display, the following items are not displayed.

- Call Sign
- Destination
-  (AIS standard) button

2.3.1.2 TT List

A TT List lists the degrees of risks of TT targets.

For the details, refer to "6.14.1 TT list".

2.3.1.3 AIS List



The AIS List lists the degrees of risks of AIS targets.

For the details, refer to "6.14.2 AIS list".



2.3.1.4 AIS Detail INFO

This window displays detail information on one AIS target.

AIS information of the target is displayed.

When either one of   is clicked on, AIS information before or after the information currently displayed is displayed.

When  that is provided next to AIS ID is pressed, the AIS pause menu is displayed, and when an item is selected, the specified AIS is set to pause.

When a safety message is received,  is set to valid display. When  is clicked on, the AIS message tray is displayed.

For the AIS message tray, refer to "2.3.2.2 AIS MSG Tray".

The following information items are displayed.

| Displayed information | Explanation |
|-----------------------|--|
| AIS ID | Displays the identification number (1 to 1000) of an AIS target. *The maximum display number is 1000 as the option. When [] that is provided next to AIS ID is pressed, the AIS pause menu is displayed, and when an item is selected, the specified AIS is set to pause. |
| Name | Displays the ship name of an AIS target. |
| Call Sign | Displays a call sign. |
| MMSI | Displays a nine-digit identification number for a ship/ground station equipped with a DSC communication device. |
| IMO No. | Displays the 9-digit IMO number. |
| Registry of Ship | Displays the registry of ship. |
| Length | Displays the length of an AIS target. |
| Beam | Displays the beam of an AIS target. |
| Destination | Displays the destination of an AIS target. |

| Displayed information | Explanation |
|-----------------------|--|
| ETA or UTC | Displays the expected arrival time of an AIS target. |
| Navigation Status | Displays the navigation conditions of an AIS target. 0: Under Way Using Engine 1: At Anchor 2: Not Under Command 3: Restricted Manoeuvrability 4: Constrained by Her Draught 5: Moored 6: Aground 7: Engaged in Fishing (fishing boat) 8: Under Way Sailing (sailing ship) 9: Reserved for HSC 10: Reserved for WIG 11: Reserved 15: Not Defined |
| Draft | Displays the draft of an AIS target. |
| Type of Ship | Displays the ship type of an AIS target. 30: Fishing Vessel 31: Towing Vessel 32: Towing Vessel L>200M B>25M (Towing and length of the tow exceeds 200m or breadth exceeds 25m) 33: Dredge or Underwater OPE (Engaged in dredging or underwater operation) 34: Vessel-Diving OPE (Engaged in diving operation) 35: Vessel-Military OPE (Engaged in military operation) 36: Sailing Vessel 37: Pleasure Craft 50: Pilot Vessel 51: Search and Rescue Vessels 52: Tugs 53: Port Tenders 54: With Anti-pollution EQUIP (Vessels with anti-pollution facilities or equipment) 55: Law Enforcement Vessels 58: Medical Transports 59: Resolution No.18:MOB-83(Ships according to Resolution No.18 (Mob-83)) 2X: WIG(Wing-in-Ground Effect Craft) 4X: High Speed Craft 6X: Passenger Ships 7X: Cargo Ships 8X: Tanker 9X: Other Type of Ship |

| Displayed information | Explanation |
|-----------------------|--|
| Cargo Category | When the setting of the type of a ship is 2X, 4X, 6X, 7X, 8X or 9X, the digit shown at the end of the code represents the cargo/condition. X1 Category X(DG/HS/MP) X2 Category Y(DG/HS/MP) X3 Category Z(DG/HS/MP) X4 Category OS(DG/HS/MP) X9 No Additional Information X0 All Ships of This Type |
| Bearing | Displays the bearing of an AIS target. |
| Range | Displays the distance to an AIS target. |
| COG or CSE | Displays the course of an AIS target. Displayed as "COG" in the course over the ground mode and "CSE" in the course through the water mode. |
| SOG or STW | Displays the ship speed of an AIS target. Displayed as "SOG" in the speed over the ground mode and "STW" in the speed through the water mode. |
| CPA | Displays the closest approach distance to an AIS target. |
| TCPA | Displays the time to reach the closest approach point to an AIS target. |
| BCR | Displays the bow crossing range of an AIS target. |
| BCT | Displays the bow crossing time of an AIS target. |
| Heading | Displays the heading of an AIS target. |
| ROT | Displays the turning speed of an AIS target. |
| Position | Displays the position of an AIS target. |
| Position Accuracy | When the position-fix accuracy of an AIS target is low, [>10m] is displayed. When the position-fix accuracy of an AIS target is high, [<10m] is displayed. |
| Position Sensor | Displays the type of the position sensor used by an AIS target. 0: Not Defined 1: GPS 2: GLONASS 3: Combined GPS/GLONASS 4: Loran-C 5: Chayka 6: Integrated Navigation 7: Surveyed 8: Galileo 9-14: Not used 15: internal GNSS |
| Status | Status of an AIS target • Sleeping • Activated • Lost • Danger • Selected |

| Displayed information | Explanation |
|-----------------------|--|
| Source | AIS information source <ul style="list-style-type: none"> • Direct • Repeated • VTS |

2.3.1.5 2nd PPI

The setting items are the same as those of the main PPI setting except for the setting items that can be specifically set under 2nd PPI.

For the details, refer to "2.2.10 Range and mode information".

| Memo |
|--|
| <ul style="list-style-type: none"> • When the numbers of the direction graduations become overlapped and cannot be distinguished, the numbers will be thinned out and displayed. • 2nd PPI is only displayed for a 26-inch screen. |

2.3.1.6 Wind/Current Block

The Wind/Current Block shows the wind speed and current information.

The following information is displayed.

| Displayed information | Explanation |
|---|--|
| Wind (Wind bearing/speed information) | Shows the wind bearing/speed information. Display varies depending on the wind bearing true/relative display method. For True Bearing display, [Bearing] (wind bearing), [Speed] (wind speed), and BFT (Beaufort scale) are displayed in numeric values. For display of a relative bearing, [Bearing] (wind direction) and [Speed] (wind velocity) are displayed in numerical values. |
| Current (Tidal current) | Shows the tidal current information. [Set] (Current set) and [Speed] (Current drift) are displayed in numeric values. |
| [N Up]/[H Up] (North Up/Head Up switching) button | Switches between N Up and H Up display for wind bearing and tidal current. Click the [N Up] (north up) button to show wind bearing and tidal current at the north up direction. Click the [H Up] (head up) button to show wind bearing and tidal current at the head up direction. |

2.3.1.7 Conning

The Conning shows simple conning information.

1 Click [Conning] on the [Page Selection] dialogue box.

When [Conning] is not displayed, drag the scroll bar downwards.

The [Conning] window is displayed.

One pane is available and the pane is provided with a window switching button .

2 Click a window switching button to show the [Contents Selection] window.

3 Click on the button of the information to be displayed on the pane.

| | |
|--------------------|---|
| [Off] | : No display |
| [Depth] | : Water depth information |
| [Water TEMP] | : Water Temperature graph |
| [Depth/Water TEMP] | : Depth graph + Water Temperature graph |
| [Rudder] | : Rudder angle information |
| [Weather] | : Weather information |
| [ROT] | : Turning speed information |
| [Current] | : Tidal stream information |

Memo

Some buttons may not be displayed depending on the installation.

2.3.2 Information reference windows

By clicking on the buttons in the window, the contents that are displayed in the window can be switched.

Information reference related windows are listed below.

| Button | Displayed content | Related section |
|--------------------|--|--------------------------|
| [AIS MSG Tray] | AIS message tray | 2.3.2.2 AIS MSG Tray |
| [NAVTEX] | NAVTEX message | 2.3.2.3 NAVTEX |
| [Active Alert] | Active alert that occurred in the equipment | 2.3.2.4 Active Alert |
| [Alert History] | Alert history that occurred in the equipment | 2.3.2.5 Alert History |
| [Maintenance INFO] | Maintenance information | 2.3.2.6 Maintenance INFO |
| [AIS] | Own ship's AIS information | 2.3.2.7 AIS |

When unread messages exist

The number of unread messages is displayed on the [AIS MSG Tray] button as a badge.

2.3.2.1 Switching between a standard window and an extended window

The information reference window can be switched to a standard window or an extended window.

To switch to an extended window: Click on the List Extension button .

To switch to a standard window: Click on the List Standard window button .

Memo

A standard window is displayed at the initial display.

When the RADAR transmission status is Transmit, the extended window cannot be displayed.

2.3.2.2 AIS MSG Tray

AIS messages are displayed.

For the details of the AIS message tray, refer to "6.11 AIS Message Tray".

2.3.2.3 NAVTEX

The NAVTEX message is displayed.

This equipment supports the NAVTEX messages of the NMEA format and NAVTEX format.

The format that is used for displaying the NAVTEX messages is determined by the installation.

A NAVTEX message list is displayed on the left side of the pane and the details of the message are displayed on the right side.

The following items are displayed.

| Displayed item | Explanation |
|---------------------|--|
| NAVTEX message list | Displays a list of NAVTEX messages. When a message line is clicked on, the details are displayed on Message Details on the right side. For the details, refer to the table of (1) NAVTEX message list shown below. |
| Message details | Displays the details of the message that was selected from the NAVTEX message list. For the details, refer to the table of (2) Message details shown below. |
| Delete... | When this button is clicked on, the [Delete] dialogue is opened. The [Delete] dialogue is displayed. A NAVTEX message can be deleted from the NAVTEX message list on this dialogue. For the details, refer to (3) [Delete] dialogue shown below. |
| Edit Position... | The [Location] dialogue is opened. On this dialogue, edit the position data of the NAVTEX symbol that is displayed on the map. For the details, refer to (4) [Location] dialogue shown below. |
| Jump | Displays the NAVTEX symbol of the NAVTEX data that has been selected from the NAVTEX message list on the chart. |
| Request Message... | The [NAVTEX Message Request] dialogue is opened. On this dialogue, message transmission can be requested to the message transmission source. For the details, refer to (5) [NAVTEX Message Request] dialogue shown below. |

(1) NAVTEX message list

| Displayed item | Explanation |
|--------------------|--|
| Date Received(UTC) | Displays a message received time. |
| Station | Displays the message transmission source base station ID (A to Z). |
| Message | Displays the message ID (A to Z). |
| [Disp] check box | When this check box is checked, the symbol is displayed. |

(2) Message details

| Displayed item | Explanation |
|-----------------|--|
| Station | Displays the message transmission source base station ID (A to Z). |
| Message | Displays the message ID (A to Z) and the name. |
| Expiration Date | Set the expiration date of the message. When the calendar icon  is clicked on, a calendar picker is displayed. Set the expiration date by using the calendar picker. The colour of the date in [Expiration Date] changes for the expired message. |
| NAVTEX Message | Displays a message. |

(3) [Delete] dialogue

| Displayed item | Explanation |
|------------------|---|
| Selected Message | When this item is selected, the message that was selected from the NAVTEX message list is targeted for deletion. |
| Before | When this item is selected, a calendar picker is displayed. Messages on and before the date that is specified by the calendar picker are targeted for deletion. |
| All Message | When this item is selected, all the messages are targeted for deletion. |
| [OK] button | Deletes the NAVTEX messages that are targeted for deletion. |
| [Cancel] button | Closes the [Delete] dialogue without deleting NAVTEX messages. |

(4) [Location] dialogue

| Displayed item | Explanation |
|-------------------|--|
| Position list | When the latitude or the longitude of any of the position data is clicked on, a numeric input software keyboard is displayed, enabling the change of the position data by inputting latitude or longitude. |
| [Insert] button | Copies the selected row to the row following the row that is selected in the location data list. |
| [Separate] button | Inserts a separator (-----) in the row following the row that is selected in the location data list. Use the separator by improving the presentation of the position data list. |
| [Delete] button | Deletes the row (location data or separator) that is selected in the location data list. |
| [OK] button | Validates the editing of the location data and closes the [Location] dialogue. |
| [Cancel] button | Invalidates the editing of the location data and closes the [Location] dialogue. |

(5) [NAVTEX Message Request] dialogue

| Displayed item | Explanation |
|-----------------|--|
| Station | Select to which base station message transmission is requested by checking the check box of the base station ID (A to Z). |
| Message | Select a type of the message to be requested by checking the check box of the message ID. |
| [OK] button | Requests the transmission of the selected message to the selected base station and closes the [NAVTEX Message Request] dialogue. |
| [Cancel] button | Closes the [NAVTEX Message Request] dialogue without requesting message transmission. |

Memo

When setting is so specified that the NAVTEX message in the NAVTEX format will be displayed by the installation, the [Request Message] button is not displayed.

2.3.2.4 Active Alert

This window displays active alerts that occurred in this equipment.
For the details, refer to "3.7.4 Displaying active alert and alert history".

2.3.2.5 Alert History

This window displays the history of alerts that occurred in this equipment.
For the details, refer to "3.7.4 Displaying active alert and alert history".

Memo

The Alert History screen is displayed under the extended window only. A standard window is not available.

2.3.2.6 Maintenance INFO

Maintenance information are displayed.

[1] Active alert information

The number of maintenance information is displayed at the top left corner.

[2] Active page information

Up to 20 maintenance information items can be displayed in one page. Use this function to switch pages when the number of maintenance information items exceeds 20, requiring multiple pages.

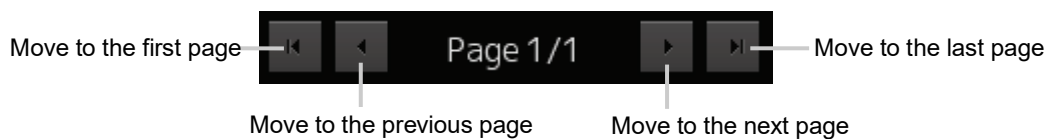

[3] Maintenance information list

Maintenance information is displayed. Click any information selects the information.

- Details of the selected information are displayed in "[4] Detailed maintenance information."
- New maintenance information generated during screen display is added to the top of the list.
- Up to 1000 pieces of information can be displayed. When 1000 pieces are exceeded, information is sequentially deleted from the oldest information.
- Either of the following icons is displayed in the [Status] column.

! : Generated

✓ : Resolved

Blank: Maintenance information which had been generated before the EUT was restarted

- The [Cause] column shows the names of maintenance information.
- The [Raised(UTC)] column shows the generation time and date (UTC) of maintenance information.
- Click any item in the title line rearranges the list with reference to the clicked item.

[4] Details of maintenance information

Details of the currently selected maintenance information are displayed.

| Displayed item | Explanation |
|-----------------|---|
| [Higher] button | The details of the alert of the higher than the alert that is currently displayed appear. |
| [Lower] button | The details of the alert of the lower than the alert that is currently displayed appear. |
| Cause | The cause of the maintenance information is displayed. |
| Raised(UTC) | The generation time and date (UTC) of the maintenance information is displayed. |
| Rectified(UTC) | The resolution time and date (UTC) of the maintenance information is displayed. |
| Details | Detailed information is displayed. |

2.3.2.7 AIS

This window displays AIS information.

The AIS window includes the "Own Ship AIS Data" window that displays the AIS information of the own ship and "Last Lost AIS Target" window that displays the information of the last AIS target that is lost.

Own Ship AIS Data window

When the [Own Ship AIS Data] button is clicked on, the Own Ship AIS Data window is displayed.

For the details, refer to "6.15 Confirming Own Ship's AIS Information".

Information window of the last lost AIS target

When the [Own Ship AIS Data] button is clicked on, the Own Ship AIS Data window is displayed.

For the details, refer to "6.16 Displaying the Last Lost AIS Target".

Section 3 Common Basic Operations

3.1 Powering On and Starting

Turn on the power supply according to the following procedure.

- 1 Press the Power button on the operation unit.

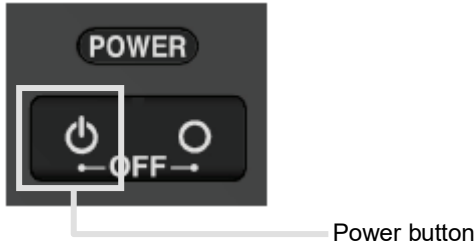

Start-up screen is displayed.

After the start-up screen is displayed, the Mode Selection screen is displayed after a brief interval.

3.2 Starting Each Mode

When this equipment starts up, a Mode Selection screen is displayed on the screen.

On the Mode Selection screen, you can select and start the desired mode from the operation modes available for this equipment.

When the button of the mode to be executed is clicked on, the screen of the mode is displayed.

Memo

When this equipment is started for the first time, if no operation is performed within 10 seconds after the Mode Selection screen is displayed, the mode screen that has been set up at the time of shipment will appear.

3.3 Basic Operations When Using a Trackball

A trackball in the operation unit is mainly used for the operations of this equipment.

This section describes the basic operations performed using the trackball.

3.3.1 Basic trackball operations

As the basic trackball operations, move the cursor that is displayed on the screen and perform various operations using the left and right mouse buttons.

3.3.2 Basic operations of clicking, right-clicking and double-clicking

The basic operations of clicking, right-clicking, and double-clicking are as follows.

| | | |
|-----------------|--|---|
| Clicking | Button | The function of the selected button is executed. <ul style="list-style-type: none">• In the case of the function On/Off button, the function is set to On/Off whenever the button is clicked on.• When a function selection type button is clicked on, a function selection menu is displayed. |
| | Single object | The primary action (priority operation) for the target object is executed. For instance, when the cursor is set to the deactivated AIS target and the mouse button is clicked on, "Activate", which is the primary action of the deactivated AIS target, is executed. |
| | Multiple objects | A list menu of the target objects is displayed. When an object is selected from the menu, the AUTO mode operation of the selected object is executed. |
| Right-clicking | Single object | A context menu of the target object is displayed. |
| | Multiple objects | A list menu of the target objects is displayed. When an object is selected from the menu, the context menu of the selected object is displayed. |
| Double-clicking | When the mouse button is double-clicked in line creation mode or at creation of a graphical route, the creation mode terminates. | |

3.3.3 Displaying simplified information and operational guide of objects



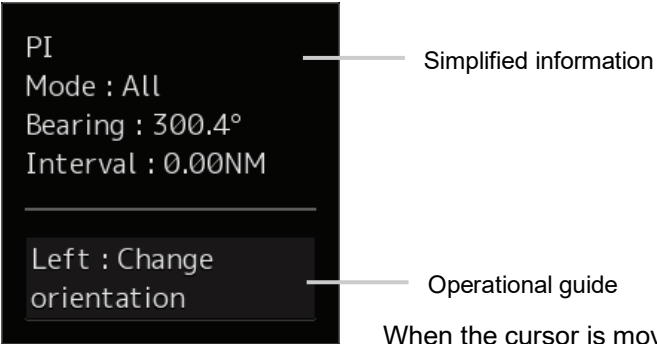



When the cursor is set to a specific object, the "simplified information" and "operational guide" are displayed.













When the cursor is moved, the display is cleared.

3.3.4 Cursor types

The following cursors are displayed by this equipment.

| Cursor | Cursor Name | Description |
|---|-------------------|--|
|  | Pointer cursor | Indicates a position on the display panel, menu bar, dialogue box, or context menu. |
|  | Cross-hair cursor | Indicates a position on the chart or PPI. In AUTO mode, this cursor is used by manual acquisition (RADAR). |
|  | Edit cursor | Moves an object in user map mode. |
|  | Offset cursor | Appears when the offset of the ship's own position is set in adjustment cursor mode. |
|  | Select cursor | Displays the position on the chart during the editing of the user map. |
|  | Mark cursor | Displayed at execution of User Map. |

| Cursor | Cursor Name | Description |
|---|--|---|
|  | Arrow cursors | Appear when any of the following operations is performed. <ul style="list-style-type: none"> • EBL/VRM, AIS filter, AZ, PI • User map • Moving the multi-view bar • Operation of EBL, VRM |
|  | Rotation cursor | Appears at PI operation. |
|  | Eraser cursor | Appears in eraser tool mode. |
|  | Target activation cursor | Appears when the cursor is moved over a sleeping AIS target. |
|  | Numeric displayed AIS target cursor | Appears when the cursor is moved over an activated AIS target or TT. |
|  | Numeric displayed AIS target cancellation cursor | Appears when the cursor is moved over an AIS digital information target or a TT digital information target. |
|  | Pointer cursor | Appears when the cursor is moved over a hyperlink. |
|  | Off-centre cursor | Appears when the RADAR off-centring mode is used. |
|  | Move cursor | <ul style="list-style-type: none"> • Appears during the dialogue box move mode. • Appears when moving an intersection point of EBL/VRM. |
|  | EBL cursor | Appears at EBL manoeuvre is created. |

3.4 Basic Menu Operations

Various functions can be executed or set from the menu that is displayed by clicking on the [Menu] button.

This section describes the basic menu operations.

3.4.1 Opening the menu

- 1 Click on the [Menu] button at the top-right corner of the top screen.



The menu is displayed.

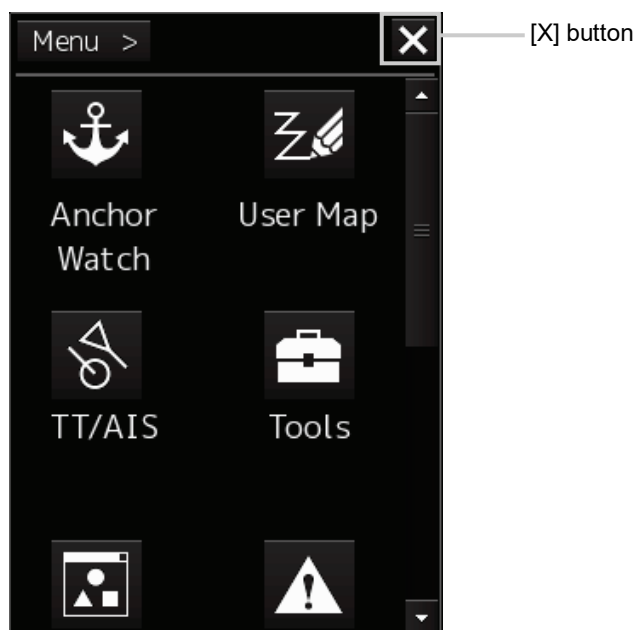

If all the menus are not displayed on one screen, scroll the screen.

- 2 Click on one of the buttons that are displayed on the menu.
A dialogue box for executing or setting the applicable function appears.
- 3 A submenu is displayed depending on the function. In this case, display a dialogue box of the function by clicking on the button on the submenu.
Example: TT/AIS

4 Some functions comprise a classification pane and an edit pane and a dialogue is available to hide the classification pane by using the Disclosure button.

Example: [Settings] is clicked on the menu.

Disclosure button

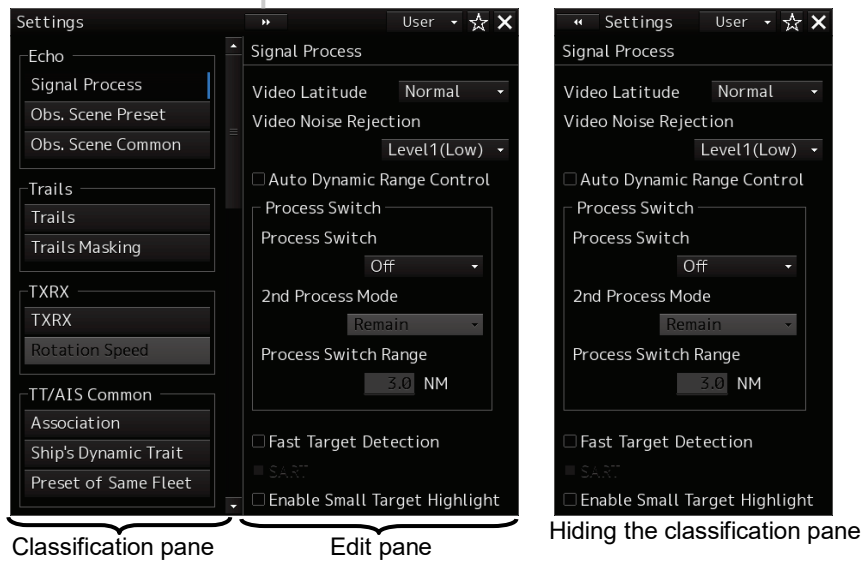

Memo

When the RADAR transmission status is Transmit and Classification is selected, the classification pane is hidden automatically.

3.4.2 Menu list

The following menus are displayed.

| Menu | Related section |
|--------------|--|
| Anchor Watch | Section 8 Monitoring a Dragging Anchor |
| Chart | Section 9 Chart |
| User Map | Section 10 Creating a User Map |
| TT/AIS | Section 6 Target Tracking and AIS |
| Tools | - |
| View | Section 11 Setting Up Screen View |
| Alert | Section 12 Setting Up Alerts |
| Settings | Section 13 Setting Up the Operation Mode |
| Maintenance | 15.1 Maintenance Functions Executed from Menu |
| Help | 3.21 Help |
| Code Input | 3.22 Password Input |
| Service | Section 14 Adjusting and Setting Up Equipment (for Services) |

Memo

When the RADAR transmission status is Transmit, the following menu items cannot be selected.

- [Chart]
- [Help]

3.4.3 Closing the menu

Click on the [X] button on the menu (submenu).

3.5 Basic Dialogue Box Operations

When a dialogue box is opened, the dialogue box is in the factory setting state or state at termination of the previous operation.

The setting can be changed by the following operation.

- Enter a character or a value in the input box.
- Select a setting from the list.
- Select a setting by clicking on the button.
- Select a setting by checking or unchecking the check box.

3.5.1 Changing dialogue box settings

This section describes the basic setting change procedure by using the [Edit and Send AIS Message] (AIS message editing/transmission) dialogue box as the example.

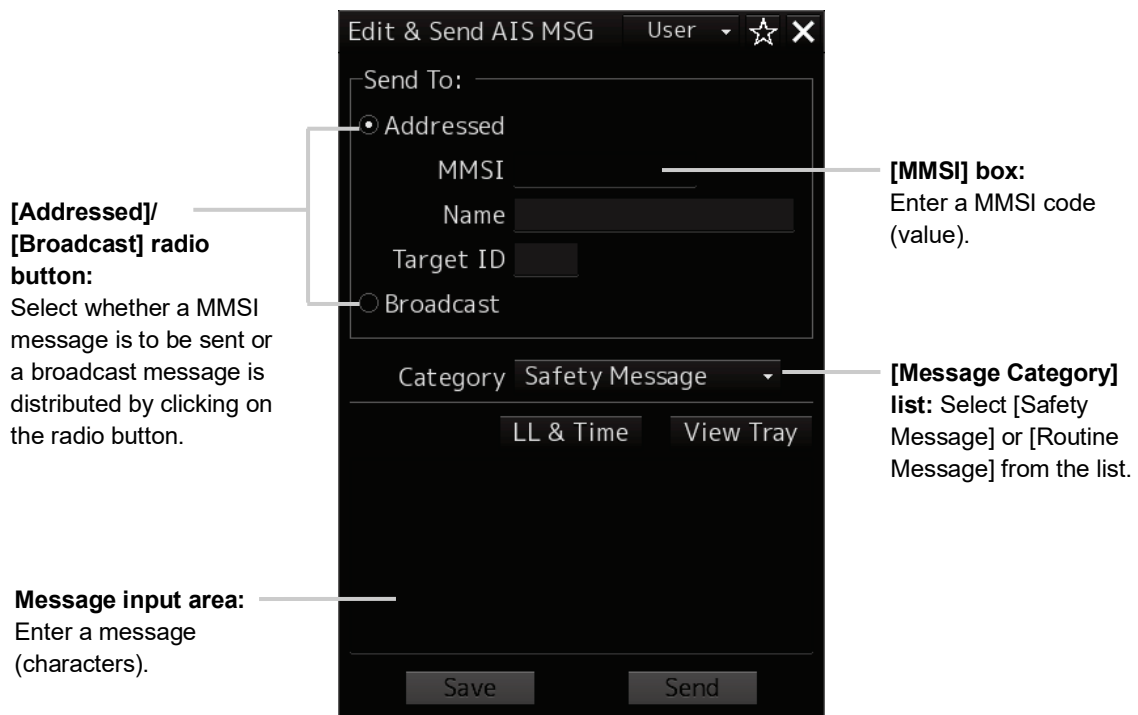

A function may also be set by opening another dialogue box from the dialogue box.

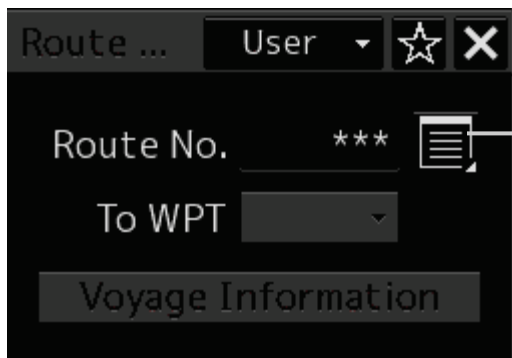

[File operation] dialogue box display button:

When this button is clicked on, the [File operation] dialogue box is opened.

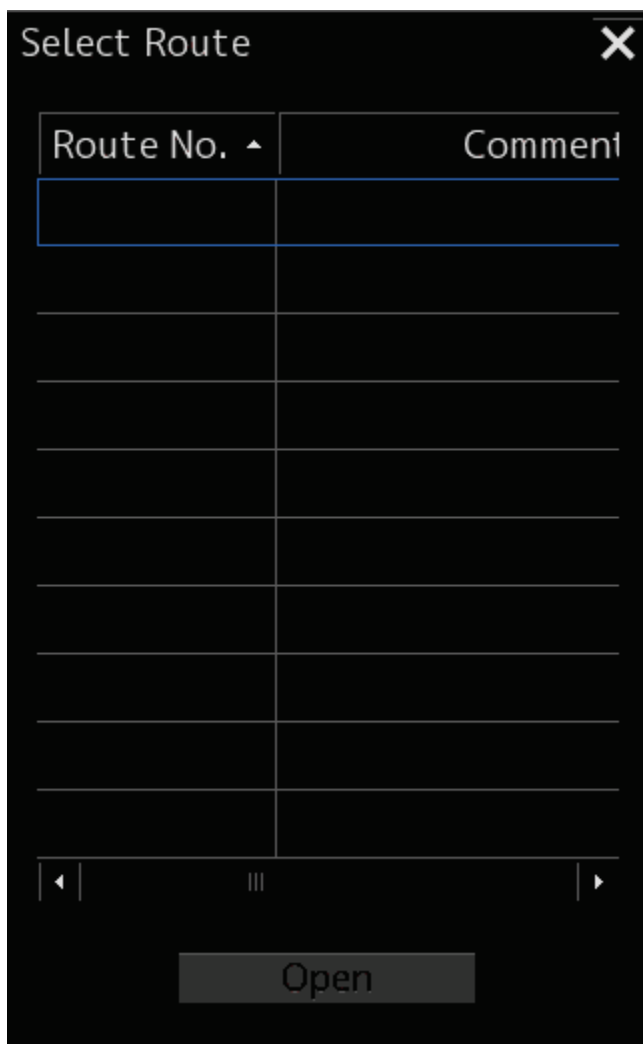

3.5.2 Closing a dialogue box

Close the dialogue box by clicking on the [X] (Close) button on the dialogue box.

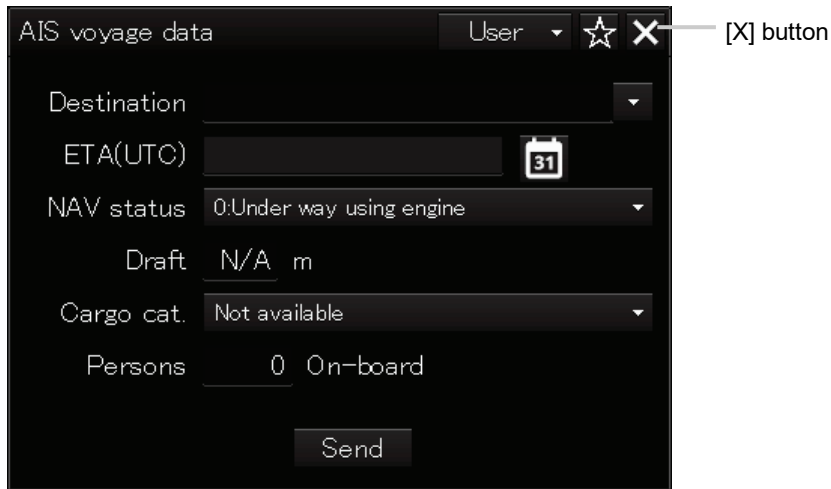

3.5.3 Title Bar

The name (title) of the dialogue box is displayed on the title bar of the dialogue box.

Title of the dialogue

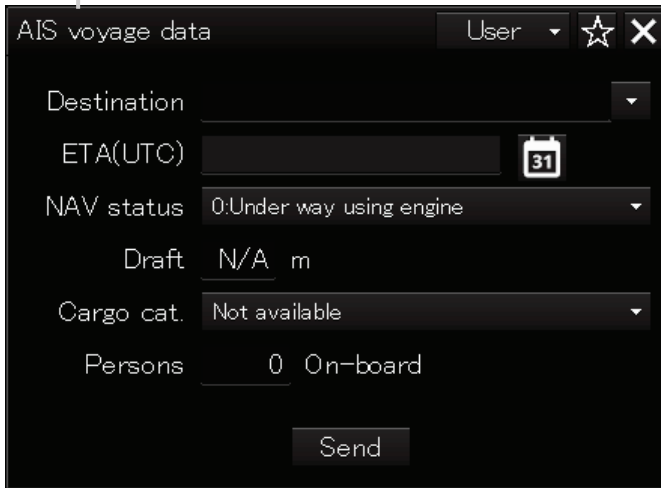

The dialogue can be moved by dragging the title bar.

WARNING



When moving the dialogue, move to the position that does not cover the PPI area. If the dialogue covers the PPI area, it may interrupt the recognition of the display information.

3.6 Operation of the Information Monitor Window

This section describes the operation and editing of the information monitor window.

For the details of the information monitor window, refer to "2.3 Common Information Window".

3.6.1 Opening the information monitor window

- 1 Click on the page switching button on the initial display window.

In the initial display, a blank window appears.

The [Page Selection] dialogue box appears by clicking on the page switching button .

- 2 Click on the monitor information to be displayed. The applicable window is opened.

Returning to the [Page Selection] dialogue box from each window

When the page switching button  on each window is clicked on, control returns to the [Page Selection] dialogue box.

3.6.2 Displaying an information monitor window from other than the [Page Selection] dialogue box

Use the following procedures to display an information monitor window from a display other than the [Page Selection] dialogue box.

| Information monitor window | Display method |
|----------------------------|---|
| Target INFO | <ol style="list-style-type: none">1) Click on the TT symbol. (Cursor AUTO mode)2) Right-click on the TT/AIS symbol and select [Readout information] from the context menu.3) Click on the AIS Activate target. (Cursor AUTO mode) |
| TT List | <ol style="list-style-type: none">1) Select TT/AIS List from [TT/AIS] on the menu. |
| AIS List | <ol style="list-style-type: none">1) Select TT/AIS List from [TT/AIS] on the menu. |
| AIS Detail INFO | <ol style="list-style-type: none">1) Select one AIS target from the AIS List and click on the Details button.2) Right-click on the AIS symbol, and select [Readout detail information] from the context menu. |

3.7 Confirming and Acknowledging an Alert

⚠ CAUTION



Information is displayed in addition to a warning or a caution in the alert status area. Information is used to report operation errors and so on to the users. Unlike other alerts, no detail display is provided for Information.

When an alert occurs, a buzzer sound is emitted and an alert balloon is displayed in the alert notification area.

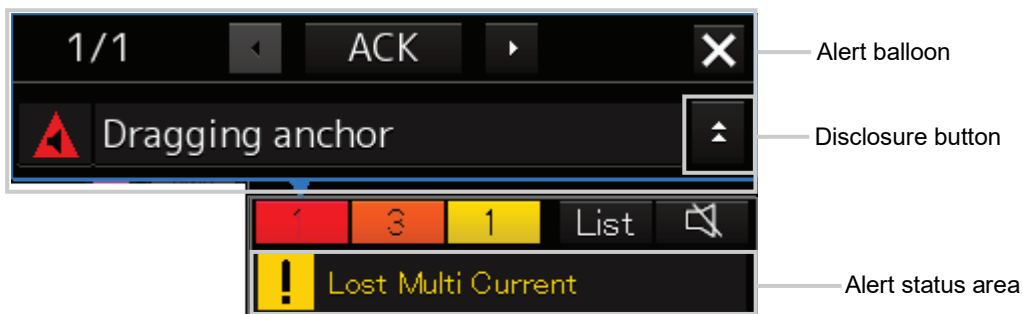

Example of alert balloon

To acknowledge the alert detailed information, click on the Disclosure button. For the details of the subsequent operations, refer to "3.7.2 Confirming alert contents".

The general procedure for handling an alert is shown below.

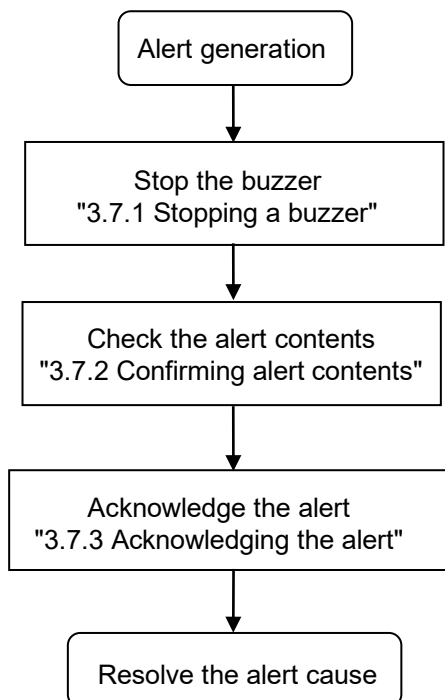

3.7.1 Stopping a buzzer

To stop a buzzer (silencing), click the silence button in the alert notification area or press the [SILENCE] key in the operation unit.



3.7.2 Confirming alert contents

When an alert is generated, the alert message is displayed in the "Alert status area".

The alert type and the number of alerts are displayed by the button.

- Alarm button: Displayed when an alarm is generated. The button is displayed in red. The number of alarms is indicated on the button
- Warning button: Displayed when a warning is generated. The button is displayed in orange. The number of warnings is indicated on the button.
- Caution button: Displayed when a caution is generated. The button is displayed in yellow. The number of cautions is indicated on the button.

1 Click on the button

An alert balloon is displayed.

2 Display the alert detail dialogue by clicking on the Disclosure button.

The alert detail dialogue can be closed by clicking on the Disclosure button again.

The following items are displayed in the detail dialogue.

| Display item | Contents |
|----------------------|--|
| Higher button | The details of the alert of the higher priority than the alert that is currently displayed appear. |
| Lower button | The details of the alert of the lower priority than the alert that is currently displayed appear. |
| Detailed information | Cause, Status, Date and time (Update), Details, Category and Priority to be taken are displayed. |

3.7.3 Acknowledging the alert

After the [ACK] (acknowledgement) button of the alert detail display dialogue box is clicked on or the [ALERT ACK] (alert acknowledgement) key of the operation section is pressed after verification of the alert contents, the alert that is currently displayed is acknowledged.

When there are multiple alerts, perform the same operation by displaying the details dialogue box of another alert.

When all the alerts are acknowledged, the alert detail display dialogue is closed automatically.

Memo

An alert can also be acknowledged by clicking on the [ACK] button in the [Active Alert] tab of the [Alert List] dialogue box.

For the details, refer to "3.7.4 Displaying active alert and alert history".

3.7.4 Displaying active alert and alert history

When a [List] button is clicked on, the "Alert List" dialogue box of the common information window is displayed.

Memo

The common information window can be switched to either the standard window display or the enlarged window display.

This section uses the enlarged window in the example.

For the details of switching between the standard window and the enlarged window, refer to "2.3.2.1 Switching between a standard window and an extended window".

In the [Active Alert] tab, a list of the current alerts is displayed. In the [Alert History] tab, a list of past alerts that have been resolved is displayed.

[Active Alert] tab

[1] Active alert information

The number of active alerts is displayed at the top left corner.



[2] Active page information

Up to 20 alert information items can be displayed in one page. Use this function to switch pages when the number of alert information items exceeds 20, requiring multiple pages.



[3] Active alert list

- The alert of the highest priority is automatically selected. When an alert in the active alert list is clicked on, the alert is selected.
- The details of the selected alert are displayed in "[4] Details of active alert".
- When a new alert is generated during the screen display, the alert is added at the top of the list.
- By clicking on any of the items in the title line, active alerts can be sorted based on the item.
- When the [ACK] button is clicked on, the alert is acknowledged.

Memo

The [ACK] button is not displayed for the [Caution] alert since acknowledgement is not required.

[4] Details of active alert

Details of the alert that is currently selected are displayed.

| Alert | Detailed information |
|-----------------|--|
| Cause: | Displays the cause of the alert. |
| Details: | Displays the details of the cause of the alert. |
| Priority: | Displays the current alert priority (identification of Alarm/Warning/Caution). |
| Category: | Displays the alert category. |
| Status | Displays the status of the alert (Raised/Silenced/ACKed/Transferred/UnACK-Rectified). |
| Updated(UTC) | Displays the latest update time of the alert. |
| [Higher] button | The details of the alert of the higher priority than the alert that is currently displayed appear. |
| [Lower] button | The details of the alert of the lower priority than the alert that is currently displayed appear. |
| [ACK] button | The alert that is currently selected is displayed. |

[Alert History] tab

Alerts that have been generated in the past are displayed.

- Up to 20 alerts are displayed per page.
- When a newly acknowledged alert is generated during the screen display, the acknowledged alert is added to the top of the list.
- By clicking on any of the items in the title line, active alerts can be sorted based on the item.

Memo

The Alert History screen is displayed under the extended window only. A standard window is not available.

3.8 Switching the Day/Night Mode

WARNING



Change of the colour of the Day/Night button, particularly the use of the [Night] colour, may interfere with the recognition of display information. Confirm display information can be recognised.

The screen display colour can be switched to any of five levels according to the brightness within the bridge. Use the following procedure for switching.

- 1 Click on the [Day/Night] button on the right toolbar.





Adjustment buttons are displayed based on the brightness that is currently set.



Example: Day2 is set.

- 2 Adjust the brightness by using the  [Light] button and the  [Dark] button.

Whenever the  [Light] button is clicked on, the brightness increases by one level from the current level.

When the  [Dark] button is clicked on, the brightness decreases by one level from the current level.

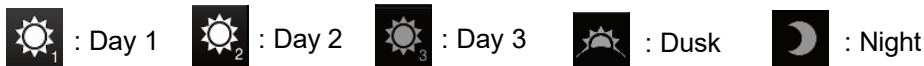

Relationship between the day/night mode and the screen/operation section brightness setting value

When the day/night mode is changed, the screen/operation section brightness is set to the following values.

| | 26-inch monitor | 19-inch monitor |
|---------------------------|---|---|
| Screen brightness | Day1, Day2, Day3: 67/100 Dusk: 60/100 Night: 11/100 | Day1, Day2, Day3: 70/100 Dusk: 62/100 Night: 10/100 |
| Operation unit brightness | Day1: Level4 / Day2: Level3 / Day3: Level2 / Dusk, Nigh: Level1 | |

3.9 Adjusting the Brightness of the Screen and Operation Unit

The brightness of the screen can be adjusted within the range from 0 to 100 and the brightness of the operation unit can be adjusted within five levels (0 to 4).

- 1 Click on the [Display and Panel Brightness] button on the right toolbar.

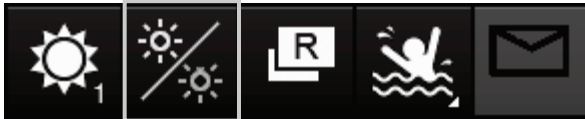

The brightness adjustment buttons of the screen and the operation unit are displayed.

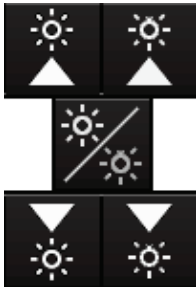

Adjust the brightness of the screen on the left side and adjust the brightness of the operation unit on the right side.

- 2 Adjust the brightness by using the  [Light] button and  [Dark] button.

Whenever the [Light] button/[Dark] button is clicked on, the brightness changes by one level.

3.9.1 [Display Brightness] dialogue

If the [MULTI] dial is operated while [Display Brightness] function is selected as the [MULTI] dial assignment function, the [Display Brightness] dialogue is displayed.

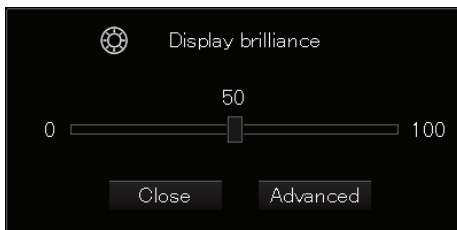

It is possible to adjust the brightness of the display section by rotating the [MULTI] dial.

In order to set an offset value so that when set to the same value as the screen brightness of other equipment, the light emitted becomes the same as in other equipment, click the [Advanced] button and

adjust the offset using the  buttons displayed for setting the [Offset].

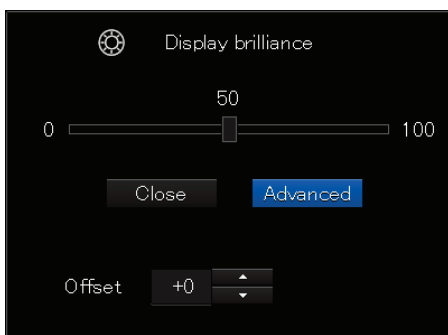

3.10 Switching the Mode

Switch the mode between the radar mode and the synthesis mode.

- 1 Click on the mode switching button on the right tool bar.

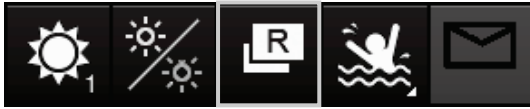

Whenever the button is clicked on, the mode switches repeatedly as [Radar mode] → [Synthesis mode] → [Radar mode].

The mode switching button icon also changes by linking with mode switching.

| Mode | Icon |
|----------------|------|
| Radar mode | |
| Synthesis mode | |

3.10.1 Function restriction by mode

Some functions are restricted in radar mode.

The following functions are restricted.

| Function | Radar mode | Synthesis mode |
|---------------------------------|---|----------------|
| Own ship's track display | Not available (Own ship's track can be set. Track data is also accumulated.) | Available |
| Other ship's track display | Not available (Tracks of other ships can be set. Track data is also accumulated.) | Available |
| Dragging anchor monitor display | Not available (Dragging anchor is monitored and alerts are also notified.) | Available |
| Rectangle cursor | Not available (A rectangle cursor can be set.) | Available |
| Edit Reference Mark | Not available (Standard display of Edit Reference Mark in (Cursor Readout) and any reference point can be set.) | Available |
| NAVTEX mark | Not available (The NAVTEX mark can be set.) | Available |
| Fishing ground display | Not available (A fishing ground can be set.) | Available |
| User map | Available | Available |

3.11 Mouseover Display

When the mouse cursor is hovered over an object on the screen, the information on the object is displayed on a popup window near the cursor.

When objects overlap, the following priority is applied and information on the object of the higher priority is displayed.

Object

- AIS target
- Tracking target
- NAVTEX (symbol)
- User map (mark)
- NAVTEX (line)
- User map (line)
- EBL1, EBL2
- VRM1, VRM2
- Parallel index lines (PI) 1 to 8
- AZ1, AZ2
- Sector Alarm
- Polygon Alarm
- AIS filter
- Dragging anchor monitoring
- NAVTEX (area)

Priority

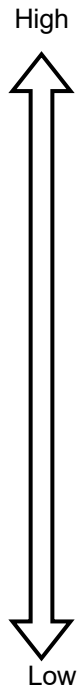

3.11.1 Condition and timing of mouseover display

3.11.1.1 Starting mouseover display

Mouseover display is performed under the following condition and timing.

| | |
|-----------|-----------------------------|
| Condition | The cursor in AUTO mode. |
| Timing | The cursor stops for 500ms. |

When the motion mode of the radar screen or chart is a relative motion display (RM) mode, the fixed object such as land moves.

In this case, mouseover display is not performed simply by hovering the cursor over the object.

By moving the cursor once and hovering the cursor over the object again, mouseover display can be performed.

For the details of the motion mode of the radar screen, refer to "5.4.6 Setting a motion mode".

3.11.1.2 Terminating mouseover display

Mouseover display terminates when the cursor is moved based on a certain distance or the mouse button is clicked.

3.11.2 How to read mouseover display

As a mouseover display example, the following information is displayed in mouseover display of AIS targets/tracking targets.

The width and height of the popup window changes according to the number of characters that are displayed.

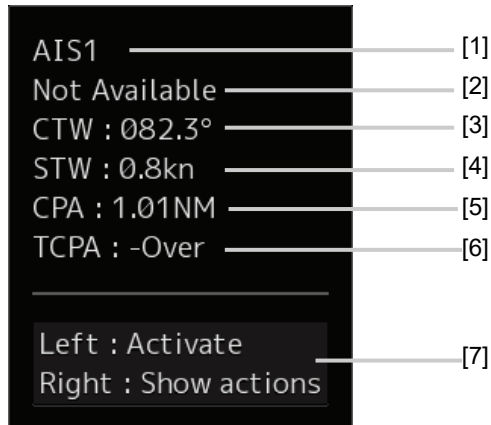

[1] Target ID

A target ID is displayed in the following notation.

AIS:

AIS + target ID

Tracking target (RADAR screen):

TT + target ID

[2] Ship's name

Displays the name of the target ship.

[3] COG or CTW

Displays the course over the ground (COG) or the course through the water (CTW).

[4] SOG or STW

Displays the speed over the ground (SOG) or the speed through the water (STW).

[5] CPA (Closest Point of Approach)

Displays the distance between the target and the closest point of approach.

[6] TCPA (Time to Closest Point of Approach)

Displays the time required to reach the closest point of approach with the target.

[7] Operation guide display area

The operations that can be performed for the mouseover displayed object are displayed.

In this example, [Left: Activate] indicates that if it is clicked on, the AIS target information can be displayed. [Right: Show actions] (right: displays the possible operations) indicates that if it is clicked on, a context menu is displayed.

3.12 MOB (Man Over Board)

When a person falls overboard, this monitoring function prevents loss of sight of the position of the person overboard.

The MOB use procedure is as follows.

- 1 Click on the MOB button on the right toolbar.



The [Marker] dialogue box appears and the MOB marker is displayed on the own ship's position when the button is clicked on.

Memo

The [Marker] dialogue box appears by clicking [Tool] - [MOB] on the menu

- 2 Monitor with the screen and the [Marker] dialogue box.

The position relationship between the own ship that is moving and the MOB marker is displayed as follows.

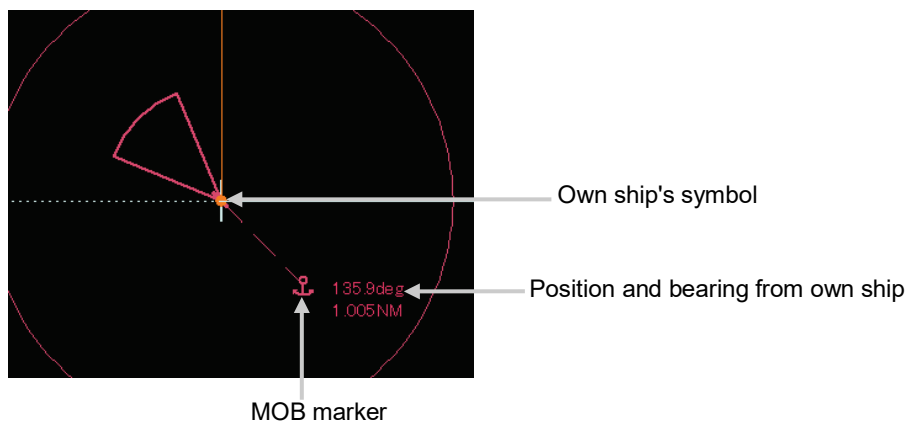

The following items are displayed in the Marker dialogue.

| Display item | Contents |
|--------------|--|
| Position | Displays the coordinate of the MOB marker. |
| Bearing | Displays the bearing from the own ship to the MOB marker. |
| Range | Displays the range from the own ship to the MOB marker. The unit of range is switched whenever the M/km/sm unit switching button is clicked on. NM denotes nautical mile, sm denotes statute mile, and km denotes kilometre |
| TTG | Displays the time to reach the MOB marker from the ship speed. |
| Time | Displays the time elapsed after clicking on the [MOB] button. |

To exit from MOB

- 1 Click on the [X] button in the [Marker] dialogue box.

A confirmation dialogue box appears.

- 2 Click on the [OK] button.

The [Marker] dialogue is closed.

The MOB marker is cleared

3.13 Electronic Bearing Line (EBL) and Variable Range Marker (VRM)

3.13.1 Electronic Bearing Line (EBL) and Variable range marker (VRM)

The electronic bearing line (EBL) and the variable range marker (VRM) are the essential tools for measuring bearings and ranges.

This equipment is equipped with two sets each for EBL (EBL1/EBL2) and VRM (VRM1/VRM2).

An intersecting point mark is displayed at the intersecting point between EBL and VRM.

By setting an intersecting point at any location, the bearing and range from the own ship's position to the location can be measured.

Two sets of EBL and VRM can be operated independently.

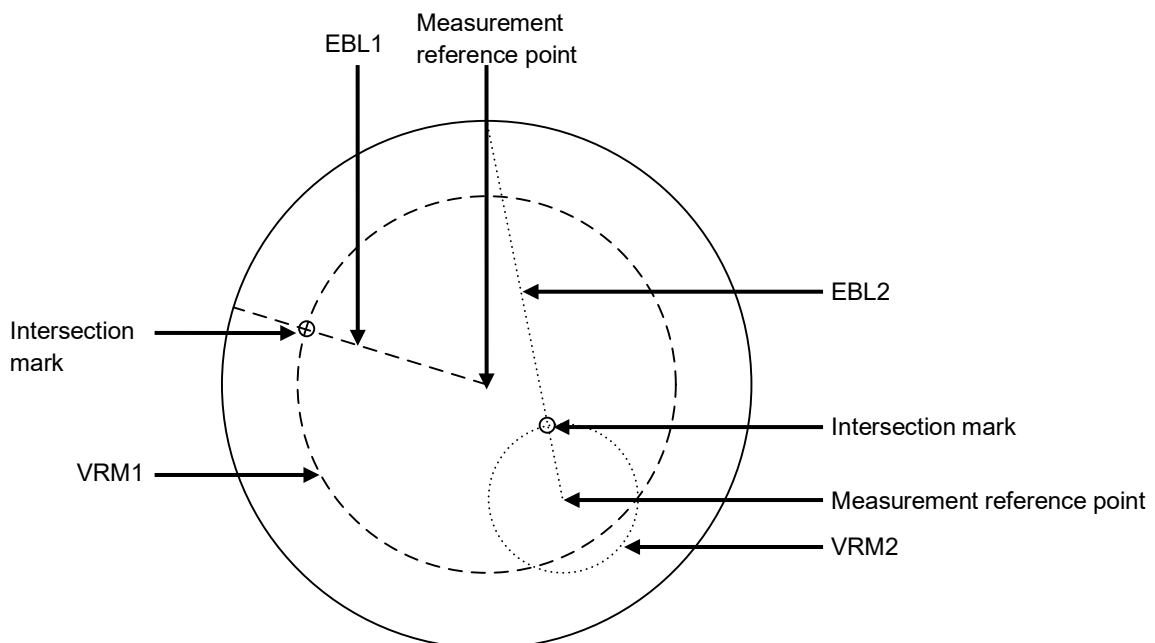

The first EBL and VRM are displayed in Long dashed line and the second EBL and VRM are displayed in Short dashed line.

Memo

The line colours can be set on the dialogue that is displayed by selecting [Settings] - [Colour and Brightness] on the menu.

3.13.2 Displaying the EBL and VRM buttons

Use the EBL/VRM button for creation and setting of EBL/VRM and bearing/range of EBL/VRM.

The EBL/VRM button is always displayed on measuring tools at the upper right corner of the screen.



Memo

The display mode of EBL/VRM that is displayed on the dialogue by selecting [View] - [Tools] on the menu can be set to display/hide.

3.13.3 Basic manipulation of EBL/VRM

3.13.3.1 Switching the control right of EBL/VRM

This equipment is equipped with two sets of EBL (EBL1/EBL2) and VRM (VRM1/VRM2).

To use EBL/VRM, the EBL/VRM to be used must be enabled.

To enable EBL/VRM, click on the EBL/VRM button.

The status of EBL/VRM can be checked by using the EBL/VRM button.

[Button in [Off] state]

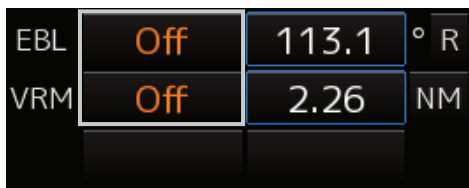

EBL/VRM is disabled and is not displayed on the screen.

When the button is clicked on, EBL/VRM is displayed and the manipulation is enabled.

[Numeric value displayed on the button]



- When the button is enclosed by a blue frame, EBL/VRM is displayed and the manipulation is enabled (with control right).
When this button is clicked on, the blue frame is cleared and the manipulation is disabled (without control right).
- When the button is not enclosed by a blue frame, although EBL/VRM is displayed on the screen, the manipulation is disabled (without control right).
When the button is clicked on, the display is changed to [OFF].
When the button is clicked twice, the button is enclosed by a blue frame and the manipulation is enabled (with control right).

3.13.3.2 Setting up the measurement starting points

The measurement starting points of the EBL/VRM in operation can be changed. Set up the measurement starting points as usage.

1 Enable the manipulation of EBL/VRM by clicking on the EBL/VRM button.

The display of the clicked button changes from [Off] to the bearing presentation of the measurement starting point.

2 Click on the Measurement Starting Point button of the EBL/VRM in the operational state.



Each time this button is clicked on, the measurement starting point switches in the order of blank field → [C] → [D] → blank field and so on.

Blank field (CCRP): Sets the measurement starting point to the own ship position (CCRP).

C (Carried): Fixes the measurement starting point on the screen.

D (Dropped): Fixes the measurement starting point at longitude and latitude point.

Memo

In the case of [D], it is necessary to connect a navigation unit.

3.13.3.3 Setting the EBL bearing to True/Relative display

The EBL bearing True/Relative display can be changed by using the True/Relative button of EBL of the Navigation Tool (measuring tools).

Setting the EBL numeric value display mode

1 Click on the true/relative button of EBL bearing.

Each time the button is clicked on, display switches between [T] → [R] → [T] in this order.

[T]: Displays EBL bearing in true bearing.

[R]: Displays EBL bearing in relative bearing.



Memo

The true/relative presentation of EBL bearing is common between EBL1 and EBL2.

3.13.3.4 Setting up the range unit of VRM

1 Click on the VRM Range Unit button.

Each time the button is clicked on, display switches in the order of [NM] → [km] → [sm] → [NM]

[NM]: Displays the range in the unit of NM.

[km]: Displays the range in the unit of km.

[sm]: Displays the range in the unit of sm.



Memo

The VRM range unit is common between VRM1 and VRM2.

NM denotes nautical mile, sm denotes statute mile, and km denotes kilometre.

3.13.3.5 Operating the intersecting point between EBL and VRM

1 Place the cursor on the intersection mark (O) and click the mouse button.

EBL and VRM are set to a movable state.

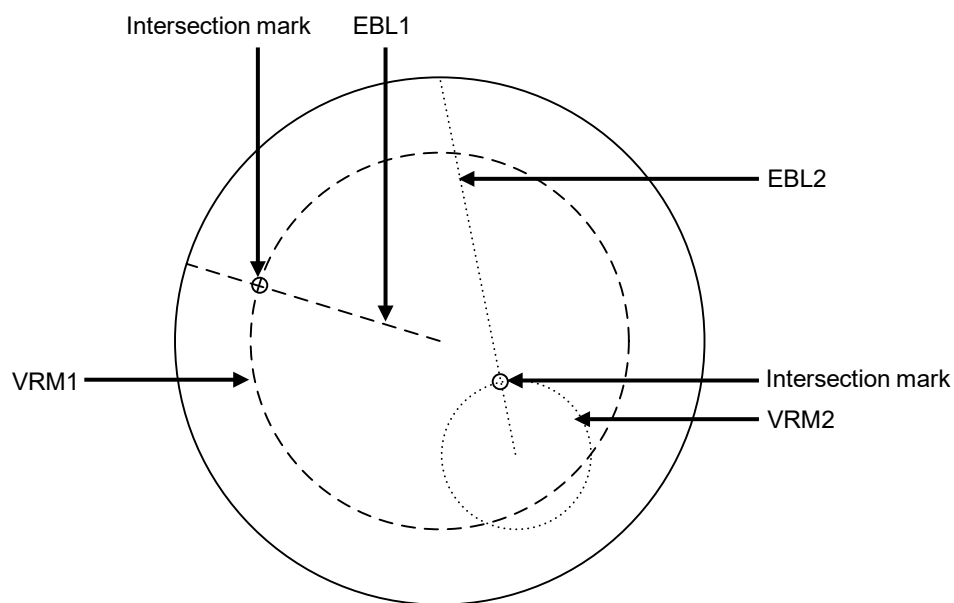

2 Move the cursor to the required target or the coordinate.

EBL and VRM move together with the cursor.

3 Click on the mouse button.

The EBL and VRM are fixed.

3.14 Rectangle Cursor

The rectangle cursor is a symbol imitating the shape of a net with the assumption of the use in trawl fishing.

[Operation procedure]

Use the following menu operation to open the setup screen of the rectangle cursor.

[Menu] button → Tools → Rectangle Cursor

The following table shows the setting items.

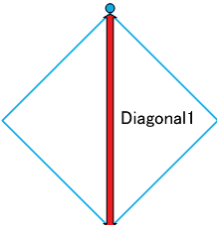
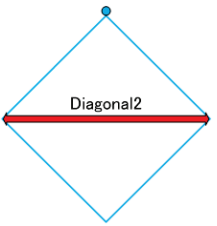
| Setting item | Contents | Setting value |
|-----------------------|--|-------------------------------------|
| Rectangle Cursor No. | Select a rectangle cursor number. | 1 / 2 |
| Display | Displays/hides the rectangle cursor. | Display: Checked Hide: Unchecked |
| Unit of Distance | Changes the length of one member of range 1 or range 2. | NM / km / sm |
| Make Rectangle Cursor | Changes the cursor mode to the rectangle cursor edit mode. | - |
| Diagonal 1 | <p>In rectangle cursor edit mode, set the length of range 1 by using the [EBL] dial. Turn clockwise: +, Turn anti-clockwise: -</p>  <p>It is possible to set from the numeric value input keyboard by selecting an input box.</p> | 0.001 to 10.000NM |
| Diagonal 2 | <p>In rectangle cursor edit mode, set the length of range 2 by using the [EBL] dial. Turn clockwise: +, Turn anti-clockwise: -</p>  <p>It is possible to set from the numeric value input keyboard by selecting an input box.</p> | 0.001 to 10.000 NM |

| Setting item | Contents | Setting value |
|--------------------|---|--|
| Rotation | In rectangle cursor edit mode, rotate the rectangle cursor by using the [MULTI] dial. Turn clockwise: +, Turn anti-clockwise: - It is possible to set from the numeric value input keyboard by selecting an input box. | 0.0 to 359.9° |
| Length of One Side | Displays the length of one side of the rectangle cursor. | Maximum value • NM: 7.071 NM • km: 13.096 km • sm: 8.139 sm |
| Simulate Closing | Set whether to close the rectangle automatically. On: The rectangle cursor moves following the movement of own ship. The rectangle cursor rotates following the rotation of own ship. Off: The rectangle cursor does not follow the movement of own ship. | Enable: Checked Disable: Unchecked |
| Distance | Set how many NM (sm/km) own ship should travel in order to close the rectangle cursor. | 0.001 to 1.000 NM |

3.15 Cursor AUTO Mode

The cursor AUTO mode (referred to as AUTO mode henceforth) is a function that automatically executes the function (operation) that is assigned to the object when the object under the cursor is clicked on.

The AUTO mode is effective for the following objects.

| Object | Section that describes the function (operation) to be executed |
|--|--|
| No object (when the button is clicked on the position without a valid object under the AUTO mode on a chart/PPI) | 3.15.1 No object |
| AIS | 3.15.2 AIS |
| TT | 3.15.3 TT |
| (AZ) Acquisition/Activation Zone | 3.15.4 (AZ) Acquisition/Activation Zone |
| AIS filter | 3.15.5 AIS filter |
| User map | 3.15.6 User map |
| EBL | 3.15.7 EBL |
| VRM | 3.15.8 VRM |
| EBL/VRM intersecting point | 3.15.9 EBL/VRM intersecting point |
| PI | 3.15.10 PI, 4.6 Using Parallel Index Lines (PI) |
| Monitoring dragging anchor | 3.15.11 Monitoring dragging anchor |

3.15.1 No object

When the button is clicked on the position without a valid object under the AUTO mode on a chart/PPI, the following operation is performed.

Acquires the TT target manually when the button is clicked on inside of the PPI.

Memo

Manual acquisition is not allowed in any of the following cases:

- Radar antenna standby state
- Occurrence of target tracking function alert.
- Occurrence of ship's heading alert.
- Using at the position further than 32 NM from the own ship's position
- Using at the position closer than 0.1 NM from the own ship's position

3.15.2 AIS

[Sleeping AIS target target]

When a sleeping AIS target is clicked on, the AIS target is activated.

[Activated AIS target]

When an Activated AIS target is clicked on, the AIS target value is displayed.

[Numeric displayed AIS target]

When the numeric displayed AIS target is clicked on, the AIS target value display is cancelled.

[AIS-SAR aircraft normal target]

When an AIS-SAR aircraft in the normal state is clicked on, the AIS-SAR aircraft is selected and the AIS-SAR aircraft value is displayed.

[Numeric displayed AIS-SAR aircraft]

When a numeric displayed AIS-SAR aircraft is clicked on, the sleeping target of the AIS-SAR aircraft is displayed and the AIS-SAR aircraft value display is cancelled.

[Sleeping AIS-SAR vessel target]

The same operation as the normal sleeping AIS target is performed.

[Activated AIS-SAR vessel target]

The same operation as the normal activated AIS target is performed.

[Numeric displayed AIS-SAR vessel target]

The same operation as the normal numeric displayed AIS target is performed.

[Sleeping AIS-SART]

The same operation as the normal sleeping AIS target is performed.

[Activated AIS-SART]

The same operation as the normal activated AIS target is performed.

[Numeric displayed AIS-SART target]

The same operation as the normal numeric displayed AIS target is performed.

[AtoN normal target]

When AtoN target in a normal state is clicked on, the AtoN normal target is selected and the numeric value of AtoN is displayed.

[Numeric displayed AtoN target]

When a numeric displayed AtoN target is clicked on, the AtoN normal target is deselected and the numeric value of AtoN normal target is cancelled.

[AIS-shore base station normal target]

When an AIS-shore base station target in a normal state is clicked on, the AIS-shore base station is selected and the numeric value of AIS-shore base station is displayed.

[Numeric displayed AIS-shore base station normal target]

When an AIS-shore base station in a normal state is clicked on, the AIS-shore base station is deselected and the numeric value of AIS-shore base station is cancelled.

[Activated AIS-MOB]

The same operation as the normal activated AIS target is performed.

[Numeric displayed AIS- MOB target]

The same operation as the normal numeric displayed AIS target is performed.

[Activated EPIRB-AIS]

The same operation as the normal activated AIS target is performed.

[Numeric displayed EPIRB-AIS target]

The same operation as the normal numeric displayed AIS target is performed.

3.15.3 TT

[TT target]

When TT target is clicked on, a numeric value is displayed.

[Numeric displayed TT target]

When a numeric displayed TT target is clicked on, the numeric value display of TT is cancelled.

3.15.4 (AZ) Acquisition/Activation Zone

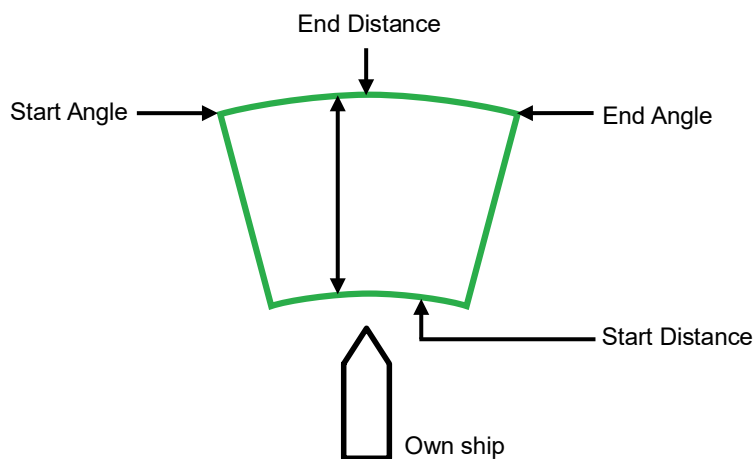

[Start Angle]

When Start Angle is clicked on, the cursor is set to the Start Angle/End Angle change mode.

[End Angle]

When End Angle is clicked on, the cursor is set to the End Angle change mode.

[Start Distance]

When Start Distance is clicked on, the cursor is set to the Start Distance/End Distance change mode.

[End Distance]

When End Distance is clicked on, the cursor is set to the End Distance change mode.

Memo

When Acquisition/Activation Zone is not displayed on the radar screen, AIS automatic activation is disabled. If automatic AIS sleeping targets activation is necessary, please set up the acquisition/activation zone.

For the setting of an acquisition and an activation zone, refer to “6.5.2 Setting up the automatic acquisition/activation zone (AZ)”.

3.15.5 AIS filter

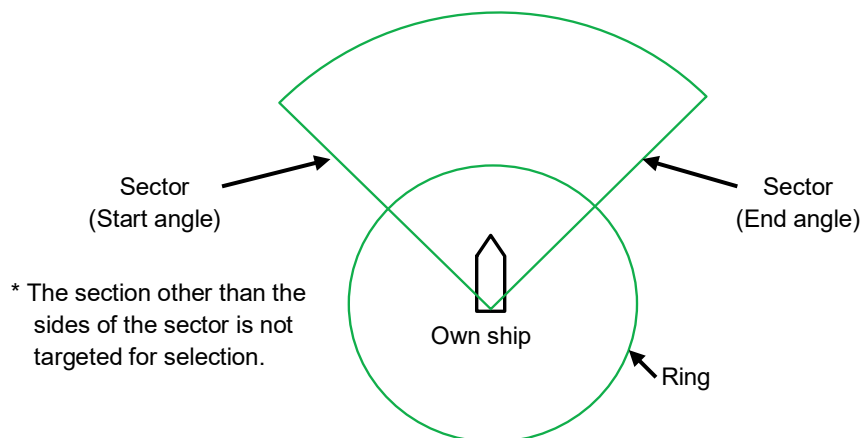

[Sector (start angle)]

When Sector (start angle) is clicked on, the cursor is set to the Sector (start/end angle) change mode.

[Sector (end angle)]

When Sector (end angle) is clicked on, the cursor is set to the Sector (end angle) change mode.

[Ring]

When Ring is clicked on, the cursor is set to the Ring change mode.

Memo

The values of Sector (start angle) and Sector (end angle) indicate relative bearings based on the ship's heading as the standard.

3.15.6 User map

The operation of an object in the unselected state is different from that of an object in the selected state.

3.15.6.1 Non-selected object

When an object created on the user map is clicked on, the object is selected and the property screen of the object is displayed.

3.15.6.2 Selected object

The operation varies according to the object.

(1) Mark

When the selected mark is clicked on, a mark move mode is set.

When you right-click, the mark move mode is cancelled.

(2) Line

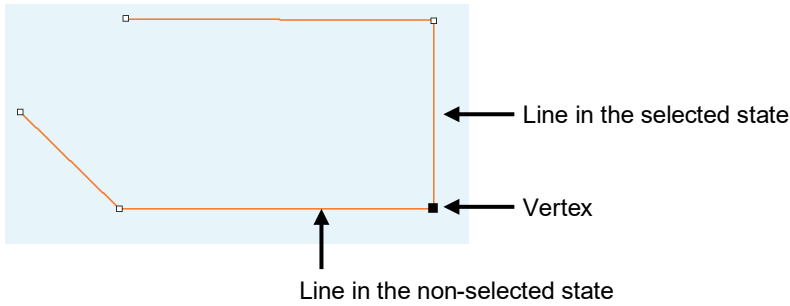

[Selecting vertex]

<Non-selected state>

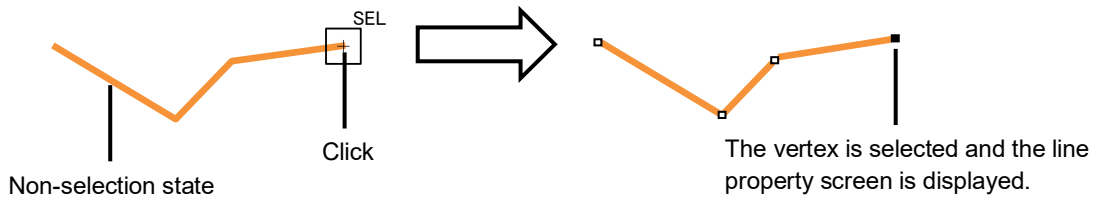

<Selected state>

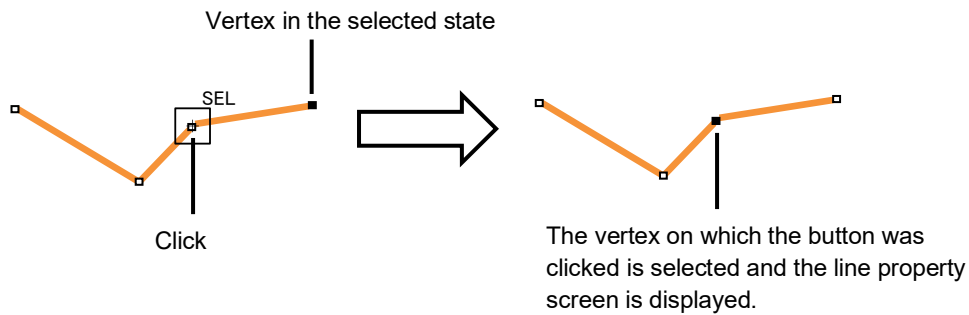

[Selecting a line segment]

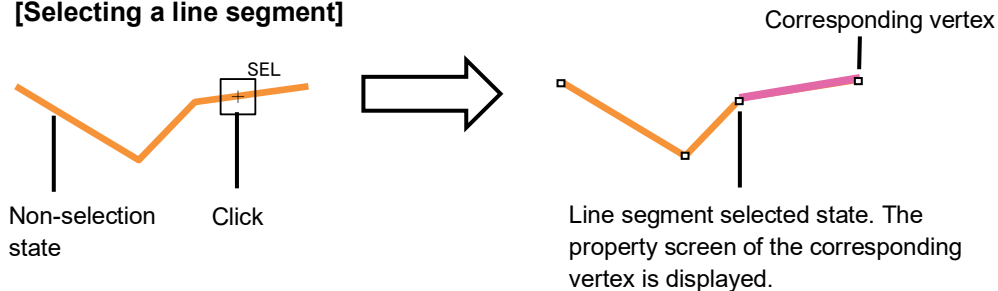

[Moving a vertex]

When the middle point of line in the selected state is clicked on, vertex move mode of line is set.

[Inserting a vertex]

When a line segment of line in the selected state is clicked on, vertex insertion mode of line is set.

Memo

A vertex can also be inserted by using [Insert Vertex] on the context menu that is displayed by right-clicking on the line in the selected state.

When the insertion point is the starting point or the ending point, a vertex can be inserted with [Add vertex].

[Cancelling operation]

When you right-click, the vertex addition, move, or insertion mode can be cancelled.

(3) Text**[Moving text]**

When the text object in the selected state is clicked on, move mode of the text object is set.

[Cancelling operation]

When you right-click, the text move mode can be cancelled.

3.15.7 EBL

When EBL is clicked, the mode becomes one in which EBL is operated alone.

3.15.8 VRM

When VRM is clicked, the mode becomes one in which VRM is operated alone.

3.15.9 EBL/VRM intersecting point

When the EBL/VRM intersection point is clicked, the mode becomes one in which EBL and VRM are operated simultaneously.

3.15.10 PI

Four PI setting modes are available and the operation of the cursor AUTO mode varies depending on the setting.

For the details, refer to "4.6 Using Parallel Index Lines (PI)".

3.15.11 Monitoring dragging anchor

3.15.11.1 Object in the unselected state

When a monitoring dragging anchor object is clicked on, the clicked object is set to the selected state and the [Anchor Watch] dialogue box is displayed.

3.15.11.2 Selected state

Dragging anchor monitoring circle

[Moving a dragging anchor monitoring circle]

When a circumference of a dragging anchor monitoring circle in the selected state is clicked on, move mode of dragging anchor monitoring circle is set.

[Changing a radius]

When a square of the four corners of a dragging anchor monitoring circle in the selected state is clicked on, radius setting mode of dragging anchor monitoring circle is set.

[Cancelling operation]

When you right-click, the dragging anchor monitoring circle move or radius change mode can be cancelled.

Dragging anchor monitoring polygon

[Moving a polygon]

When a vertex of a dragging anchor monitoring polygon in the selected state is clicked on, a vertex move mode of dragging anchor monitoring polygon is set.

[Inserting a vertex]

When a line segment of a dragging anchor monitoring polygon in the selected state is clicked on, a vertex insertion mode of dragging anchor polygon is set.

Memo

A vertex can also be inserted by using [Insert vertex] on the context menu that is displayed by clicking the right button on a dragging anchor monitoring polygon in the selected state.

[Moving a polygon]

When an inside of the dragging anchor monitoring polygon in the selected state is clicked on, a total shift mode of dragging anchor monitoring polygon is set.

[Cancelling operation]

When you right-click, the vertex move, insertion or dragging anchor monitoring polygon move mode can be cancelled.

3.16 Saving the Screen That Is Currently Displayed

The image that is displayed on the screen can be saved as a PNG file.

Use the following procedure to save screen images.

- 1 **Click on the Disclosure button**  **on the toolbar.**

Buttons normally hidden are displayed.

- 2 **Click on the screen capture button** .

The screen that is currently displayed is saved and the next confirmation dialogue box is displayed.

When the screen contents cannot be saved:

When the screen contents cannot be saved due to insufficient disc free space, an error dialogue is displayed.

In this case, secure sufficient disc free space and save the contents again.



3.17 “Favourite” Registering Function

By registering a frequently used menu as a favourite, the menu can be accessed quickly by selecting it from the list of favourites.

3.17.1 Registering/cancelling favourites

An icon for registering favourites is available on the screen title bar of each menu. By selecting the icon, a menu can be registered as a favourite or registration can be cancelled. Up to 20 menus can be registered as favourites.

The following table shows the favourite registration icon states.

| Button display | Description |
|---|--|
|  | The menu has not been registered as a favourite. By selecting the icon in this state, the menu can be registered as a favourite. |
|  | The menu has been registered as a favourite. By selecting the icon in this state, the registration of the favourite can be cancelled. |
|  | Favourite registration is disabled. Since the number of menus that have been registered as favourites reached the maximum, no further registration is allowed. |

3.17.2 Calling a favourite

By displaying a favourite list screen from the tool bar of the top screen, call a favourite.

Use the following procedure.

- 1 Click on the Disclosure button  on the Tool Bar.

Buttons that are normally hidden appear.

- 2 Click on the Favourite button  .

A confirmation dialogue is displayed and the screen is saved.

| Display item | Contents |
|------------------|---|
| Check box | When this check box is checked, the line is selected and when the [Delete] button is pressed, the selected favourite is deleted. The check box of the title line switches all the lines to On/Off. |
| [Delete] button | Deletes the selected favourite. |
| [Favourite] list | Displays the list of the menus that are registered as favourites. The item is hyper-linked and if one link is selected from the list, the related menu is called. |

3.18 [MULTI] Dial

3.18.1 Functions of [MULTI] dial

By turning the [MULTI] dial, the functions that are assigned to the [MULTI] dial can be operated. Assignment to the [MULTI] dial can be changed.

3.18.2 Functions assigned to [MULTI] dial

3.18.2.1 Displaying a screen for setting the function that is assigned

By pressing the [MULTI] dial, the setting screen for the function that is currently assigned can be displayed.



3.18.2.2 Changing the function that is assigned

1 Press the [MULTI] dial.

The [Key Assignment] dialogue box of the assigned function is displayed.

2 Select a function to be assigned from [Multi Dial] by turning the [MULTI] dial.

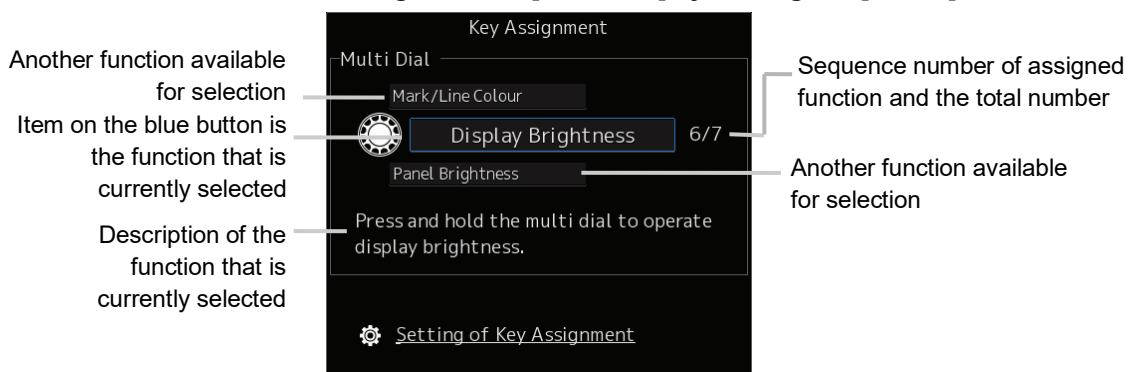

The table below lists the functions that can be assigned.

| Function name | Function outline |
|--------------------|---|
| Vector Time | Selection of a vector length |
| Trails Length | Selection of a radar trail length |
| C UP Angle | Change of the course-up angle |
| Own Track Colour | Selection of an own track colour |
| Mark/Line Colour | Selection of a mark/line colour |
| Manual Tune | Adjustment of manual tuning |
| Display Brightness | Adjustment of brightness of the display panel |
| Panel Brightness | Adjustment of brightness of the operation panel |
| Gain | Adjustment of sensitivity |
| Sea | Removal of sea clutter |
| Rain | Removal of rain and snow clutter |

3 Press the [MULTI] dial.

The selected function is set to the assigned function.

3.19 Basic Operations of the Software Keyboard

Use a software keyboard for inputting numeric values and characters in various setting operations. This section describes the basic operations of a software keyboard.

3.19.1 Starting a software keyboard

When the mouse button is clicked on a numeric input text box on such as a dialogue box, a numeric input software keyboard is displayed.

When the mouse button is clicked on a character input text box, a character input full keyboard is displayed.

3.19.2 Name and function of each section of the keyboard

Numeric value input software keyboard

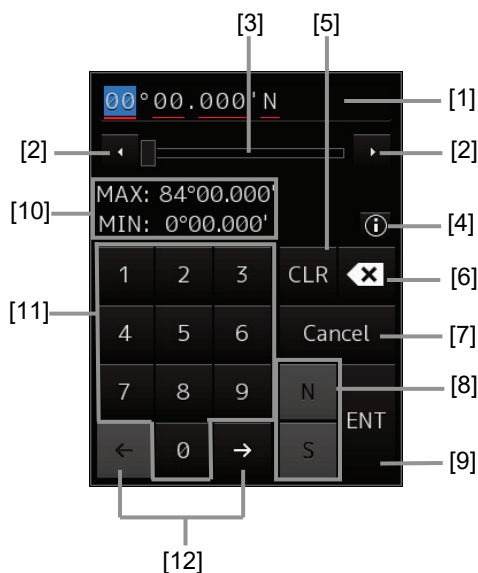

Software full keyboard for character input

* The description of the functions common to those of a numeric value input software keyboard is omitted.

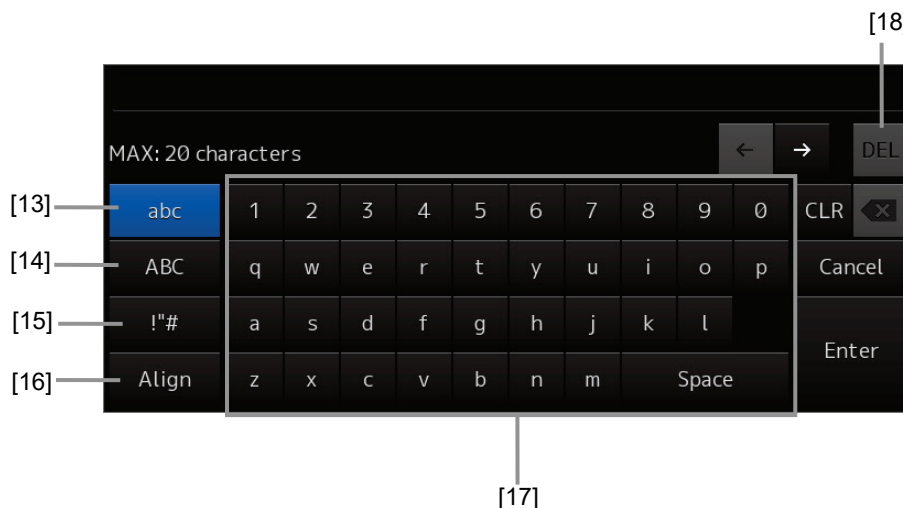

[1] Input value display section

Displays the value that is input/edited through the software keyboard.

[2] Spin button

- When the right spin button is clicked on, the minimum unit value that can be set is added to the value that is displayed. When the left spin button is clicked on, the minimum unit value that can be set is subtracted from the value that is displayed.

35° 00.000' N



36° 00.000' N

Example of addition

- When the mouse button is held down on the right spin button, the value is added consecutively. When the mouse button is held down on the left spin button, the value is subtracted consecutively.
- When the value set by the right spin button operation exceeds the maximum value, the minimum value is set subsequently. When the value set by the left spin button operation becomes lower than the minimum value, the maximum value is set subsequently.

[3] Numeric value slider

When the value adjustment button on the value slider is clicked on, the input value increases or decreases.

[4] Operation guide display button

Displays an operation guide.

To close the operation guide, click on the operation guide display button again or click on a location other than the operation guide.

[5] [CLR] key

Clears the input value that is currently selected.

[6] Back Space key

Clears the input value on the left-side of the cursor position.

[7] [Cancel] key

Cancels the input operation and closes the software keyboard.

[8] Option key

Displays the following keys according to the type of the software keyboard.

- Signed keyboard: + key and - key
- Latitude software keyboard: Direction key (N key and S key)
- Longitude software keyboard: Direction key (E key and W key)

[9] [Enter] key

Determines the input operation.

[10] Input range display section (format display section)

Displays the values and character types that can be input.

[11] Numeric keys

Use the keys for input of numeric values.

[12] Arrow keys

When there are multiple input parts, the active part can be moved to the left/right by clicking on the arrow key.

Example:



When the (left arrow key) is clicked on, the input section moves to "12".



When the (right arrow key) is clicked on, the input section moves to "000".

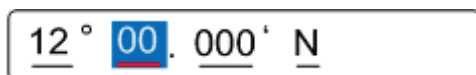

[13] Lowercase character switching key

Changes the character input key mode to the lowercase character mode.

[14] Uppercase character switching key

Changes the character input key mode to the uppercase character mode.

[15] Symbol switching key

Changes the character input key mode to the symbol mode.

[16] Key alignment switching key

Switches the character key alignment between QWERTY alignment and alphabetic alignment.

[17] Character input key

Use this key for character input.

[18] [DEL] key

Deletes the character on the right-side of the cursor.

3.20 Setting a Date and a Time (Calendar Operation)

Set a date and a time on the calendar input screen.

The following calendar types are available.

- Calendar picker
- Calendar picker + Time picker
- From-To calendar picker + Time picker

3.20.1 Details and usage of a calendar picker and a time picker

3.20.1.1 Details of a calendar



[1] Year selection spin button

Selects a year to be displayed in the date selection box.

- When the right spin button is clicked on, the year is changed in the ascending order.
- When the left spin button is clicked on, the year is changed in the descending order.

[2] Month selection spin button

Selects a month to be displayed in the date selection box.

- When the right spin button is clicked on, the month is changed in the ascending order.
- When the left spin button is clicked on, the month is changed in the descending order.

[3] Day selection box

Selects a day.

[4] Time selection spin button

Sets an hour, a minute, and a second.

- When the upper spin button is clicked on, the hour, minute, and second are changed in the ascending order.
- When the lower spin button is clicked on, the hour, minute, and second are changed in the descending order.

[5] [OK] button

Completes the setting and closes the calendar.

3.21 Help

Help information on the operation of this equipment can be displayed.

[Operation procedure]

Perform the following menu operation to open the Help screen.



[Menu] button → Help

For the details of installation of Help, refer to “15.7 Updating Help Data”.

Memo

The Preface, Section 1 and Appendix A are not displayed in the Help.

The following items are displayed on the Help screen.

| Display item | Contents |
|---|---|
| Backward button  | The display of the content display pane goes backwards by one. |
| Forward button  | The display of the content display pane goes forwards by one. |
| [Contents] tab | Displays the contents. The contents are displayed in the content pane. For the procedure, refer to "Searching the required information from the contents" below. |
| Content pane | The contents are displayed in tree format. When an item is clicked on, the related contents are displayed in the content display pane. |
| [Search] tab | Searches the character string in Help. |
| Content display pane | Displays the contents of the item that was clicked on. |

Searching the required information from the contents

1 Click on the [Contents] tab.

The contents are displayed on the contents pane.

2 Click on the item containing the required information.

The contents of the item that was clicked on are displayed on the contents display pane.

Searching terminologies

1 Click on the [Search] tab.

A search character input box is displayed.

2 Enter a required terminology and click on the [Search] button.

Search is performed within Help. When the applicable terminology is hit, the item containing the terminology is displayed on the contents pane.

3 Click on the item containing the required information.

The contents of the item that is clicked on are displayed on the contents display pane.

3.22 Password Input

Equipment settings are protected by a password. To open the dialogue box of the protected setting function, the password input is necessary.

[Operation procedure]

Perform the following menu operation to open the password input screen.

[Menu] button → Code Input

- 1 Enter "0" (zero) and click on the [Enter] key.**
- 2 Display the menu by clicking again on the [Menu] button, and change over to the second page using the page switching button.**

The [Service] button is displayed in the menu.

- 3 Click on the [Service] button.**

Check that service-related menus are displayed in the sub-menu.

Subsequently, service-related menus can be set.

3.23 Managing Files with File Manager

WARNING



Confirm computer virus does not exist in external storage media beforehand when reading and writing of the file by using external storage media.

Influences other equipment when the display unit is infected with the virus, and it may cause a breakdown.

The file manager function enables the copying of route files and user map from the hard disc of this equipment to external storage media or from external storage media to the hard disc of this equipment.
[Operation procedure]

Perform the following menu operation to open File Manager.

[Menu] button → Tools → File Manager

Memo

When the RADAR transmission state is Transmit, File Manager cannot be selected.

3.23.1 File management

The [File Management] tab enables file management. File management copies files between SSD of this equipment and external storage media and deletes files.

The following table shows the items that are displayed by the [File Management] tab.

| Item | Contents |
|------------------|---|
| File Type | Select a file type. For the details of selectable types, refer to Step 2 of "3.23.1.1 Copying a file". |
| Drive (Left) | Select a drive from the combo box. |
| Drive (Right) | Select a drive from the combo box. |
| Copy >> | Copies the file that was selected from the [Drive] list on the left side to the [Drive] list on the right side. |
| << Copy | Copies the file that was selected from the [Drive] list on the right side to the [Drive] list on the left side. |
| Delete | Deletes the selected file. |
| File List | |
| Check box | Select a file to be copied or deleted. |
| Name | Displays a list of the file names of the type that was selected by File Type. |

3.23.1.1 Copying a file

This section describes file management by using the example copying a file in the file list of the drive that is specified in the [Drive] combo box on the left hand side of the dialogue box to the drive that is specified in the [Drive] combo box on the right hand side.

- 1 Click on the [File Management] tab.**
- 2 Select the drive that contains the file to be copied from the [Drive] combo box.**
Files in the drive are displayed in the list.

The following file types can be displayed by the [File Management] tab.

| File type | File extension | Contents |
|--------------------|----------------|--|
| User Map | uchr | User map |
| Own Track | otr | Own ship's track |
| Target Track | ttr | Track of other ship (including the GPS buoy) |
| Screen Shot (AUTO) | png | Automatically generated screen shot |
| Screen Shot (User) | png | Manually generated screen shot |
| Preference | ini | Personal setting |

- 3 Select the files to be copied by checking them.**
- 4 Select a drive of the storage destination from the [Drive] combo box and select a copy location from the folder tree that is displayed.**
- 5 Click on the [Copy>>] (copy to the right) button.**
The files will be copied. When the drive of the copy source and the drive of the copy destination are reversed, click on the [<<Copy] (copy to the left) in Step 5.

3.23.1.2 Deleting a file

- 1 Select a file to be deleted by checking it. Click on the [Delete] button.**
A deletion confirmation dialogue is displayed.
- 2 To delete the file, click on the [OK] button.**

3.23.2 Loading and saving files

The [File Load/Save] tab enables loading and saving files.

The following table shows the items that are displayed by the [File Load/Save] tab.

| Item | Contents |
|--------------------------------------|--|
| File Type | Select a file type. Either Own Track or Target Track can be selected. |
| Load Mode | Set a file loading mode from the combo box. Either Overwrite or Add can be selected. |
| [Load] button | Loads the file that was selected from the list. |
| [Save Current Target Track] button | Saves the track that is currently displayed. The "Target Track" section of the button varies according to the selected File Type. |
| [Delete Current Target Track] button | Deletes the track that is currently displayed. The "Target Track" section of the button varies according to the selected File Type. |
| Display Track | Displays the number of own ship's tracks that are currently displayed in File Manager. This item is displayed only when "Own Track" is selected in File Type. |
| MAX | Displays the maximum number of own ship's tracks. This item is displayed only when "Own Track" is selected in File Type. |
| File List | |
| Name | Displays the file name. |
| Modified | Displays the date when the file was last modified. |
| Display | When this item is checked, the track of the file is displayed temporarily. |

3.23.2.1 Loading files

- 1 Click on the [File Load/Save] tab.
- 2 Select a file to be loaded.

Memo

Only one file can be selected each time.

- 3 Select the file loading mode from the [Load Mode] combo box.
- 4 Click on the [Load] button.
A confirmation dialogue box appears.
- 5 Click on the [OK] button.
The selected file is loaded.

3.23.2.2 Unloading data (clearing data from the data screen)

- 1 Click on the [File Load/Save] tab.
- 2 Select a file type from the [File type] combo box.
- 3 Click on the [Save Current Target Track] button.

Memo

The name of the Delete button varies according to the file type.

A confirmation dialogue box appears.

- 4 Click on the [OK] button.
The Target track data that is stored is cleared from the screen.

3.23.2.3 Saving files

- 1 Click on the [File Load/Save] tab.
- 2 Select a file type from the [File type] combo box.
- 3 Click on the [Save Current Target Track] button.

Memo

The name of the Save button varies according to the file type.

A confirmation dialogue box appears.

- 4 Enter a name under which the file is saved in the input box and click on the [OK] button.
The Target Track that is stored is saved.

3.24 Using a Key Macro

This function enables the recording of a key operation and by calling the recorded operation, automatic operation can be performed.

3.24.1 Recording a key macro

A key operation can be recorded for each user key. Under the connection with the standard operation unit, up to two key macros can be recorded.

[Operation procedure]

Perform the following menu operation to open the key macro registration screen.

[Menu] button → Tools → Record Operation

Memo

When the RADAR transmission state is Transmit, "Record Operation" cannot be selected.

The following table shows the items that are displayed on the macro registration screen.

| Item | Contents |
|--------------------------------|--|
| User Key No. | Select a user key number to be registered. Only the numbers of the user keys to which a key macro is assigned are displayed. |
| Name | Set a macro name. A character string of up to 16 characters can be specified. A null character cannot be specified. |
| [Record] button | Executes the recording of the key operation. |
| [Exit Operation Record] button | Closes the key macro registration screen. This function does not stop the recording of the key operation. |
| Operation List | |
| No. | Displays the key operation number. |
| Operation | Displays the key operation that has been recorded. |

The key macro recording procedure is shown below.

- 1 Open the [Record Operation] screen and select a user key to be recorded from the [User Key No.] combo box.**
- 2 Enter a name of the macro in the [Name] input box. The default name is "Operation X (X: user key number)".**
- 3 Press the [Record] button. The recording of the key operation starts.**

If another key operation has already been recorded in the selected user key, the key operation already recorded will be cleared when the [Record] button is pressed.
- 4 Execute the key operation to be recorded.**

Only the key operations including right-clicking and left-clicking can be recorded in key macros and rotation/pressing of a trackball or dial is not recorded. User keys and power supply buttons are not recorded either.
- 5 At completion of key operation, press the [MULTI] dial. This terminates the recording of key operation.**

Up to 10 key operations can be recorded. Recording also terminates when the number of key operations reaches 10.

3.25 Operate remotely the Marine VHF Radiotelephone (JHS-800S)

Channel settings and DSC call of VHF Radiotelephone (JHS-800S) can be operated from taskstation, it can be communicated from a distance place by wireless speaker microphone. ADDRESS(MMSI code) for DSC call of JHS-800S can be taken from AIS target on RADAR PPI.

Note

For more details of VHF Radiotelephone JHS-800S, please refer to instruction manual of JHS-800S.

3.25.1 Select VHF Radiotelephone (JHS-800S) for use

First of all, select the JHS-800S.

- 1 Click on the [Menu] button on the upper right of the screen.**

The menu is displayed.

- 2 Click on the [Settings] button on the menu.**

The settings dialog is displayed.

3 Select [VHF] in the classification pane.

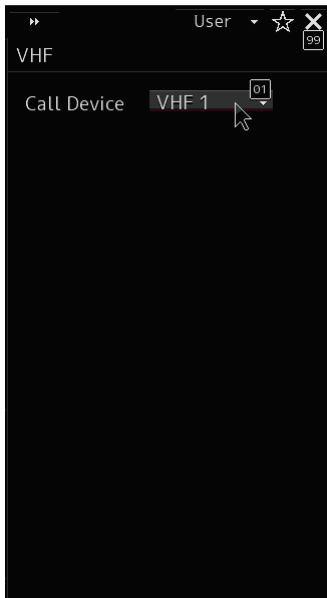

4 Select JHS-800S on the [Call Device] combo box for VHF communication.

The JHS-800S connected to the radar can be selected from up to 3 equipment.

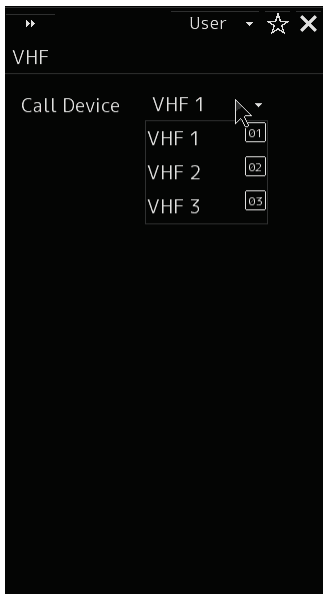

3.25.2 Display VHF Radiotelephone status from menu-bar

For confirming/changing a JHS-800S communication channel, open the JHS-800S window from menu-bar. And also, DSC call is available on the window by input parameters such as ADDRESS (MMSI code).

*It is not possible to operate the [VHF Call] window on the radar screen during operation of the JHS-800S.

- 1 Click on the [Menu] button on the upper right of the screen.

The menu is displayed.

- 2 Click on the [Tools] – [VHF Call] button on the menu.



The [VHF Call] window is displayed. Confirm the number of JHS-800S that you selected on the settings dialog is displaying on title bar of the window.

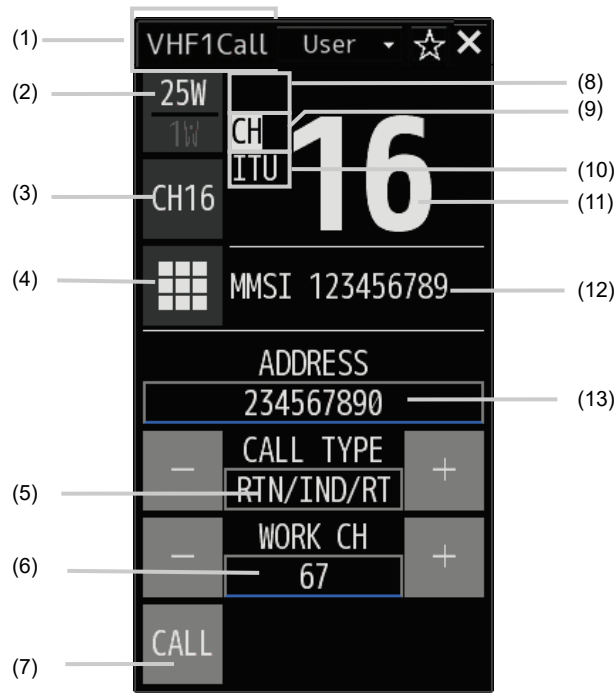

(1) Title bar

Displays selected VHF Radiotelephone (JHS-800S). You can change it on [VHF] pane on the [Settings] dialog.

(2) Output power

Switches transmitting power between 25 W and 1 W.

(3) [CH16] button

CH16: Sets the radiotelephone to CH16 (or another priority channel).

(4) Numeric key button for channel select

Displays the numeric key pad (input 0 to 9) for selecting channels (figure on the right). And, push "DSC OPE" button to return back to DSC edit screen.

(5) [CALL TYPE] selector

Selects type of DSC call. Note that the both of distress and urgency calls on this dialog are not allowed on this screen.

(6) [WORK CH] selector

Selects communication channel to use after DSC call. CH16 is not selectable when the category is routine.



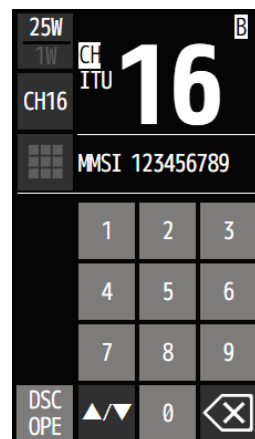

(7) [CALL] button

Start DSC call by these inputted settings. When calling the individual station, the communication can be started by the wireless speaker microphone after received the acknowledgement.





(8) [SCAN/DW/TW]

On scanning, Indicates the current condition as follows. And its displayed only scanning mode.

- Scanning : 
- Dual Watch : 
- During triple watch : 
- During transmitting : 





(9) [CH]

Indicates the channel category as follows.

- Priority channel such CH16, CH70 : 
- Other channels : 

(10) [ITU]

Indicates the type of a current channel region.

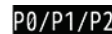
- ITU channel : 
- USA channel : 
- Canada channel : 
- Inland waterway channel : 
- Private channel : 

(11) Channel number

Indicates the current channel.

(12) Own ship's MMSI Code

Indicates the ship's MMSI.

(13) [ADDRESS] input

Use numeric key button if input destination ADDRESS (MMSI code) by manually. After all 9 digits are inputted it is accepted automatically.

*When inputting (6) [WORK CH] selector, (12) Own ship's MMSI Code and (13) [ADDRESS] input, key input from the operation unit is impossible.

While the JHS-800S is operated or when the call of the JHS-800S ends, the following popup window is displayed.

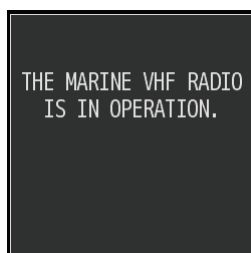

(a) During operation of the JHS-800S

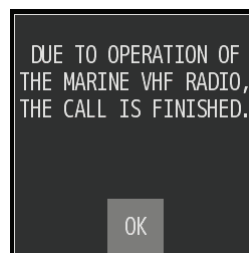

(b) When the call is finished

3.25.3 DSC call for AIS target on RADAR PPI

[VHF Call] dialog can be shown by right-click menu of AIS target on RADAR PPI.

If the task station already received MMSI code of the AIS target, the MMSI code is shown on the [VHF Call] dialog. The MMSI code on the [VHF] dialog is available for the VHF DSC calls.

1 Right-Click the AIS target on the RADAR PPI.

The context menu is displayed.

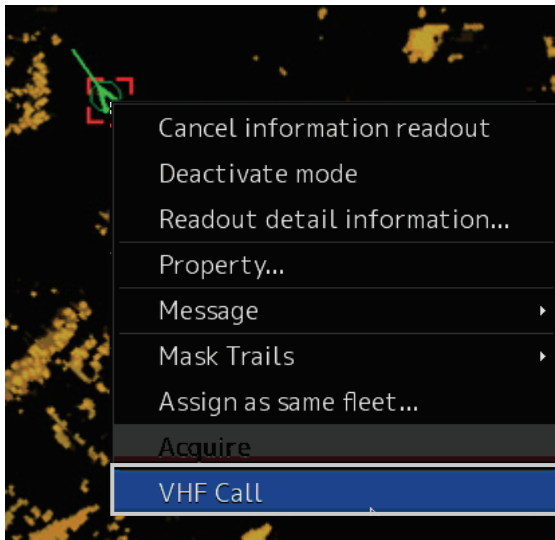

Also, the [VHF Call] context menu is displayed on TT symbol that is associated with AIS information.

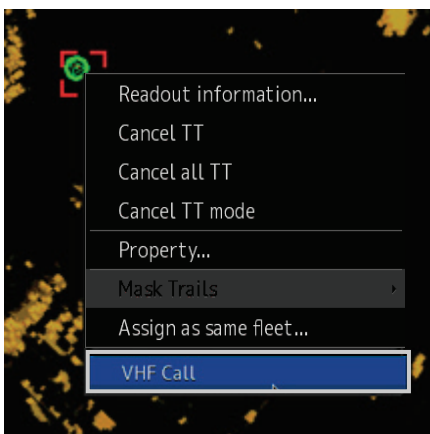

2 Click the [VHF Call] menu on the context menu.

The [VHF Call] dialog is displayed.



3 Click the [CALL] button on [VHF Call].

Selected VHF Radiotelephone (JHS-800S) will start DSC call.

When calling the individual station, the communication can be started by the wireless speaker microphone after received the acknowledgement.

In the example case above, the DSC call including ADDRESS(MMSI) as 234567890 and the communication channel as CH67 is sent to the vessel. Additionally, "CALL TYPE" and "WORK CH" can be changed if needed.

*It is not possible to operate the [VHF Call] window on the radar screen during operation of the JHS-800S.

*When inputting (6) [WORK CH] selector, (12) Own ship's MMSI Code and (13) [ADDRESS] input, key input from the operation unit is impossible.

While the JHS-800S is operated or when the call of the JHS-800S ends, the following popup window is displayed.

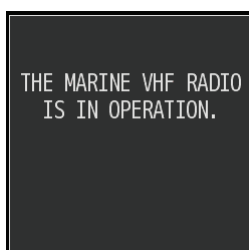

(a) During operation of the JHS-800S

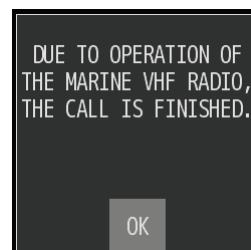

(b) When the call is finished

3.26 Returning to the Mode Selection Screen by Terminating Operation

[Operation procedure]

Perform the following menu operation to open the Password screen.

[Menu] button → Code Input

- 1 Enter 9999 and click on the [Enter] key.
Control returns to the Mode Selection screen.

3.27 Terminating This Equipment

WARNING



When turning off the power supply, do not hold down the power button of the operation unit.
Otherwise, a trouble may occur due to termination failure.

- 1 Press the power supply button on the operation unit.

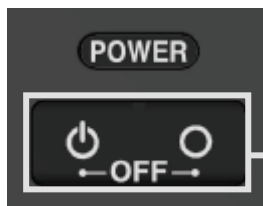

Power button
Please press the 2 keys
simultaneously.

The power is turned off.

Section 4 Range and Bearing Measurement Methods

4.1 List of Measuring Tools

This equipment is equipped with the following measuring tools to measure the range and bearing.

| Measuring tool | Function | Related section |
|---------------------------------------|--|---|
| Cross-Hair Cursor (Cursor) | Used to measure the range and bearing from the own ship's position. | 4.3 Using the Cross-hair Cursor |
| Range Rings | Displays concentric circles having CCRP (Consistent Common Reference Point) as the centre at constant intervals in order to be used as guidance for measuring the range. | 4.4 Using the Range Rings |
| Electronic Bearing Lines (EBL1/EBL2) | Displays a straight line that specifies an arbitrary bearing in order to measure the bearing from own ship. This equipment is equipped with two electronic bearing lines (EBL1 and EBL2). | 4.5 Using the Electronic Bearing Line (EBL) and Variable Range Marker (VRM) |
| Variable Range Markers (VRM1/VRM2) | Displays a circle that specifies an arbitrary range in order to measure the range from own ship. This equipment is equipped with two variable range markers (VRM1 and VRM2). | |
| Parallel Index Lines (PI) | Displays a group of straight lines at equal intervals in order to be used for complex measurement and guidance for route. | 4.6 Using Parallel Index Lines (PI) |
| EBL Manoeuvre | Displays a predictable track when own ship is turned in order to be used as guidance for manoeuvring. | 4.7 Using the EBL Manoeuvre |
| Manual position fix (Position Offset) | Enables offsetting the own ship's position with manual operation. | 4.8 Offsetting the Own Ship's Position Manually (Position Offset Function of Manual position fix) |

4.2 Target Position

The radar transmits the pulse-modulated radio waves. The transmitted waves are received in the target after being reflected (echoed). On the screen, the waves spread in the pulse width range direction based on the target position as the front edge of the echo.

When measuring a target or setting a mark/line on the target, place the cursor on the front edge of the echo.

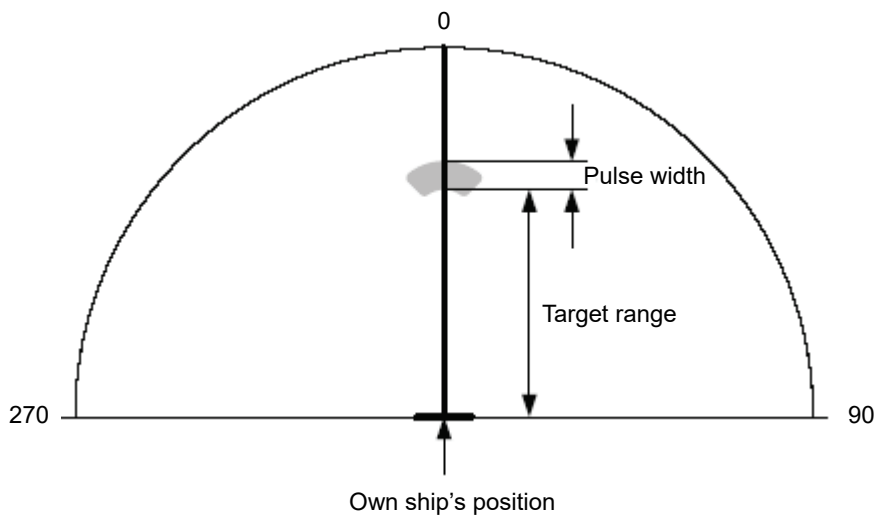
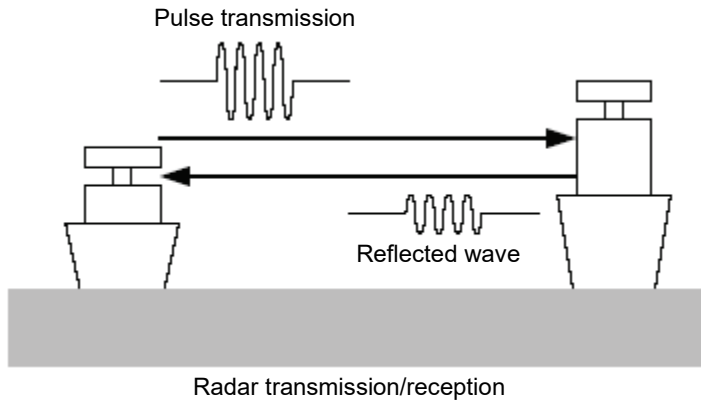

Relationship of range between the echo and the target and the pulse width

4.3 Using the Cross-hair Cursor

When moving the cursor into a window, it changes to a cross-hair cursor. With the cross-hair cursor, the bearing and position of a target can be measured.

The information that is measured by the cursor is displayed in the cursor readout information area.

4.3.1 Displaying information in the cursor information readout area

Display the cursor information by using the following procedure.

[Placing the cursor inside of PPI]

When the cursor is placed on PPI, the cursor information on the cursor position is displayed in the cursor information readout area at the top right corner of the screen.



4.3.2 Measuring the bearing and the range from the own ship's position to the target by using the cross-hair cursor

The measurement method is as follows.

Memo

When placing the cursor on the target, place the cursor on the front edge (towards the own ship of the echo) (CCRP side) of the echo.

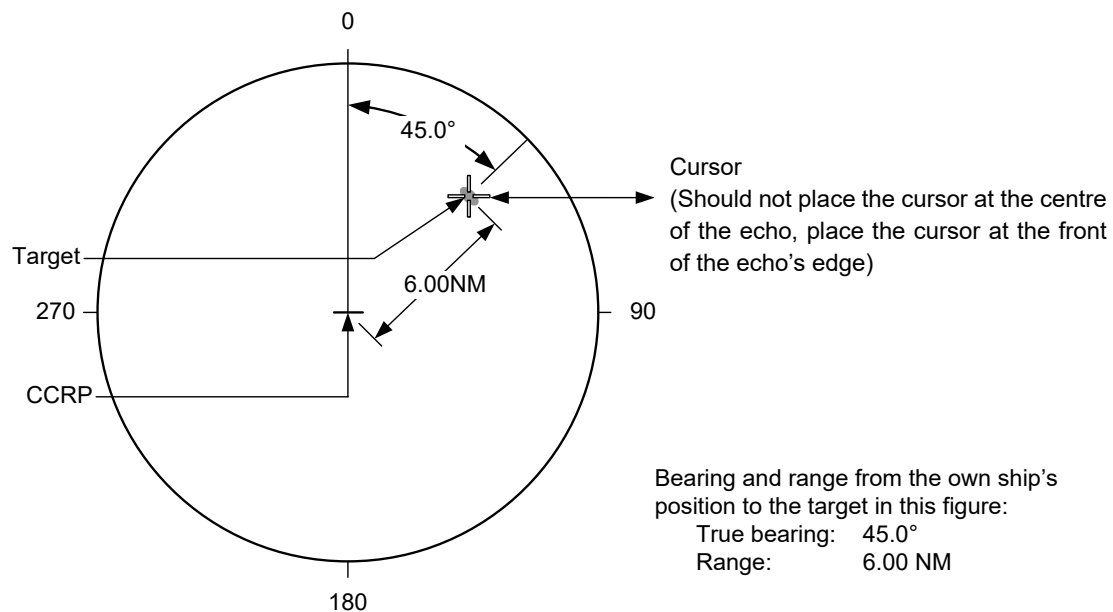

4.3.2.1 Measuring by using the cursor information that is displayed by placing the cursor inside of PPI

1 Place the cursor on the target.

When the cursor is placed on the target, the following cursor information is displayed.

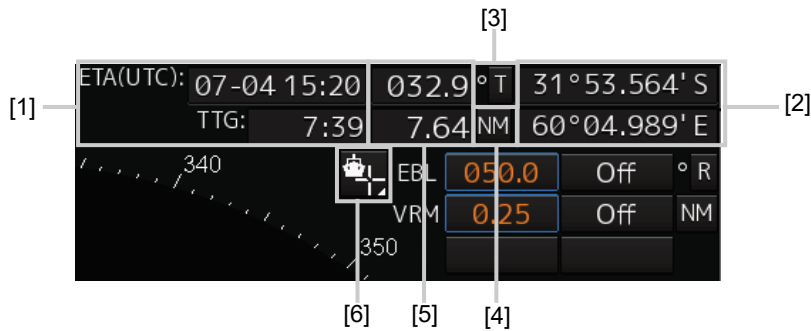

[1] TTG display and ETA display

Displays TTG and ETA from the own ship's position to the cursor position.

[2] Latitude and longitude of the cursor position

Displays the latitude and the longitude of the cursor position.

[3] True/Relative display of cursor direction

Click on the button to switch the direction display between true and relative.

The icon changes between [T] and [R].

[T] : The cursor direction is displayed as true bearing.

[R] : The cursor direction is displayed as relative bearing.

[4] Cursor distance display unit

Click on the button to change the unit to display the cursor distance.

The unit changes between [NM], [km], and [sm].

[NM] : The distance is displayed in NM units.

[km] : The distance is displayed in km units.

[sm] : The distance is displayed in sm units.

Memo

NM, km, and sm stand for sea miles, kilometres, and statute miles, respectively.

[4] Cursor bearing display and cursor range display

Displays the bearing and range from CCRP to the cursor.

[5] Selecting a reference point to be used for measurement



For the details, refer to "4.3.2.2 Setting a reference point".

4.3.2.2 Setting a reference point

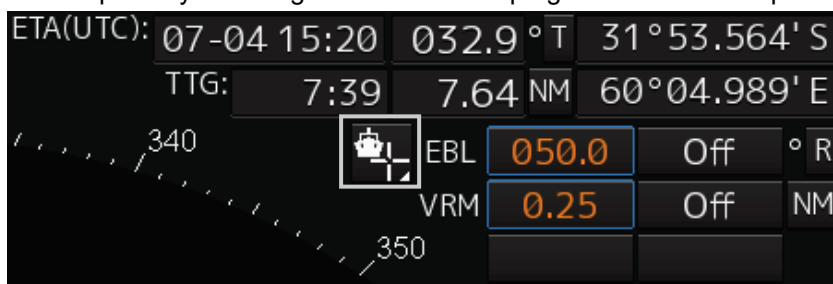
Set a reference point by selecting the icon at the top right corner of the top screen.



The following table shows the setting items.

| Setting item | Description | Icon displayed |
|-----------------------|--|---|
| From Own Ship | Own ship is used as the reference point. |  |
| From Ref. Mark1 to 20 | Select one of the reference points 1 to 20 that were specified arbitrarily. This item can be selected only when arbitrary reference points have been created. This item cannot be selected if the latitude/longitude of own ship or ship's heading of own ship is invalid. |  |
| Edit Ref. Mark... | Displays the arbitrary reference point edit screen. For the details, "Editing/deleting an arbitrary reference point" described below. | - |

Editing/deleting an arbitrary reference point

A reference point can be added by selecting [Add Reference Mark] (addition of a measurement reference point) from the context menu or by directly inputting the latitude and longitude on the [Edit Reference Mark] screen.

A reference point can be added, edited, or deleted on the [Edit Reference Mark] screen.

[Operation procedure]

Perform the following menu operation to open the [Edit Reference Mark] screen.

[Menu] button → Tools → Edit Reference Mark

| Item | Description |
|-----------------|---|
| No. | Select No. to be added, edited, or deleted. Only the items that are allowed to be added, edited, or deleted can be selected. |
| LAT/LON | Input the latitude/longitude of the arbitrary reference point. When an input of a latitude is confirmed, input of a longitude is enabled. When an input of longitude is confirmed, the inputs of the latitude and longitude are confirmed. |
| [Delete] button | Deletes the selected item. This item is enabled only when any No. is selected. |

4.4 Using the Range Rings

Range rings are multiple concentric circles displayed on the PPI screen.

Using range rings on the PPI screen, the range to a target can be measured by determining at which scale interval the target is positioned.

The display of range rings can be turned on/off according to the following procedure.

- 1 Click the Rings button in Range and mode information.

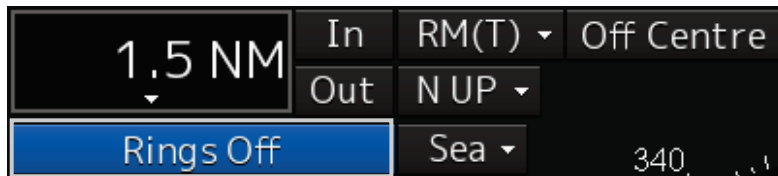

Each time this button is clicked on, display switches between On and Off.

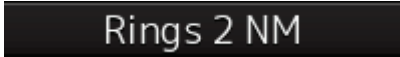
On: 

Off: 

Memo

By using the dialogue that is displayed by clicking on [View] - [Tools] on the menu, the display can be switched to On/Off.

The colour and brilliance of Range Rings can be set. For the details, refer to "11.1.11 Setting up the Display of Range/Bearing Measurement Function".

4.5 Using the Electronic Bearing Line (EBL) and Variable Range Marker (VRM)

4.5.1 Measuring a range and a bearing with EBL and VRM

4.5.1.1 Measuring a range and a bearing with the trackball section of the operation unit

When the cursor is in AUTO mode, EBL and VRM can be operated on the trackball section of the operation unit. This section describes the manipulation under EBL1 and VRM1; however, the same manipulation can be performed under EBL2 and VRM2 also.

Memo

To manipulate the EBL/VRM, the RADAR transmission status must be "Transmit".

- 1 Enable the manipulation of EBL1 by clicking on the [EBL1] button.

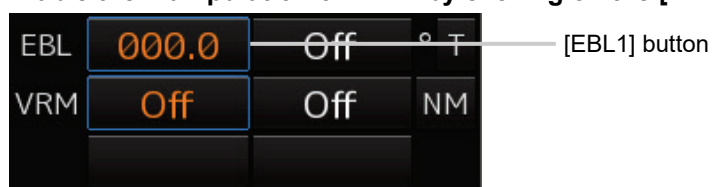

- 2 Enable the movement of EBL1 by clicking on the EBL1 line.

- 3 Align the cursor with a target and click on the mouse button.

The bearing of the target is displayed on the [EBL1] button.

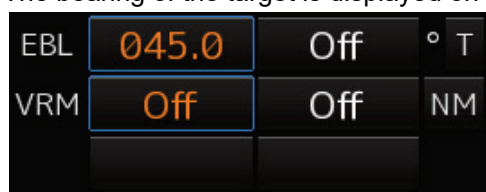

- 4 Enable the manipulation of VRM1 by clicking on the [VRM1] button.

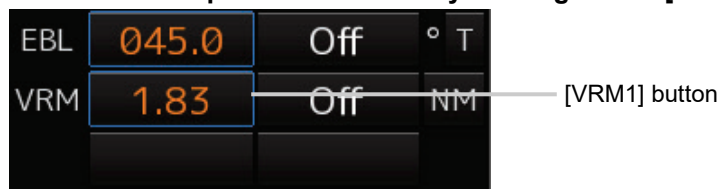

- 5 Enable the movement of VRM1 by clicking on the VRM1 circle.

- 6 Align the cursor with a target and click on the mouse button.

The range of the target is displayed on the [VRM1] button.



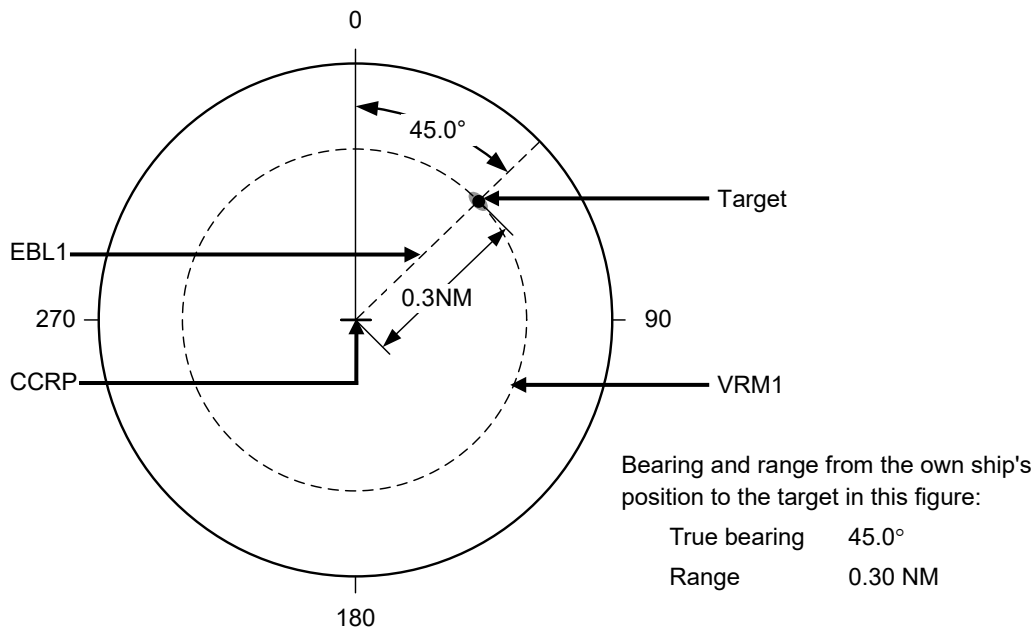

4.5.1.2 Measuring with the [EBL] or [VRM] dial on the keyboard operation unit

- 1 Press the [EBL] dial.**
The context menu is displayed.
- 2 By turning the dial, select either [EBL1 Control] or [EBL2 Control].**
- 3 Press the [EBL] dial.**
If [EBL1 Control] is being selected, manipulation of EBL1 is enabled.
If [EBL2 Control] is being selected, manipulation of EBL 2 is enabled.
- 4 By turning the [EBL] dial, align the EBL with a target.**
The bearing of the target is displayed on the [EBL1] button.
- 5 Press the [VRM] dial.**
The context menu is displayed.
- 6 By turning the dial, select either [VRM1 Control] or [VRM2 Control].**
- 7 Press the [VRM] dial.**
If [VRM1 Control] is being selected, manipulation of VRM1 is enabled.
If [VRM2 Control] is being selected, manipulation of VRM2 is enabled.
- 8 By turning the [VRM] dial, align the VRM with a target.**
The range of the target is displayed on the [VRM1] button.

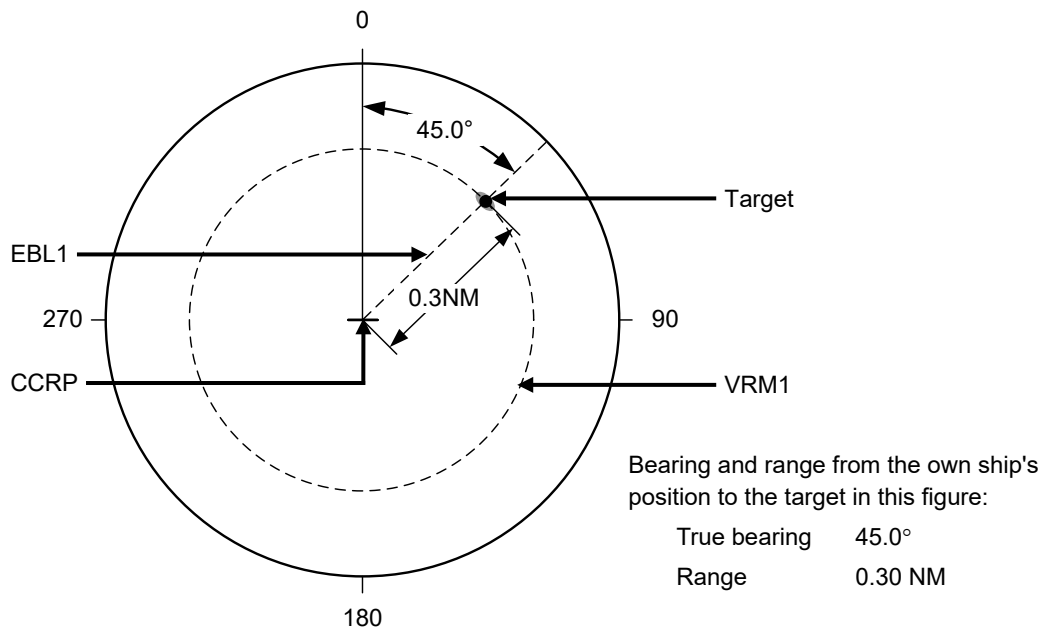

To clear the EBL:

- 1 Press the [EBL] dial.**
The context menu is displayed.
- 2 By turning the dial, select either [EBL1 Hide] or [EBL2 Hide].**
- 3 Press the [EBL] dial.**
If [EBL1 Hide] is being selected, the selection of EBL1 is cleared.
If [EBL2 Hide] is being selected, the selection of EBL2 is cleared.

To change the measurement starting point of the EBL:

The measurement starting point can be changed from the own ship's position to another.

- 1 Press the [EBL] dial.**
The context menu is displayed.
- 2 By turning the dial, select either [EBL1 Control (Carried)] and [EBL1 Control (Dropped)] or [EBL2 Control (Carried)] and [EBL2 Control (Dropped)].**
- 3 Press the [EBL] dial.**
If [EBL1 Control (Carried)] and [EBL1 Control (Dropped)] is being selected, manipulation of EBL1 is enabled.
If [EBL2 Control (Carried)] and [EBL2 Control (Dropped)] is being selected, manipulation of EBL2 is enabled.
- 4 Move the cursor to change the measurement starting point.**
- 5 The measurement starting point is fixed by clicking on it.**

To clear the VRM:

- 1 Press the [VRM] dial.**
The context menu is displayed.
- 2 By turning the dial, select either [VRM1 Hide] or [VRM2 Hide].**
- 3 Press the [VRM] dial.**
If [VRM1 Hide] is being selected, the selection of VRM1 is cleared.
If [VRM2 Hide] is being selected, the selection of VRM2 is cleared.

4.5.2 Measuring between arbitrary two points

The range and bearing between arbitrary two points can be measured as follows.

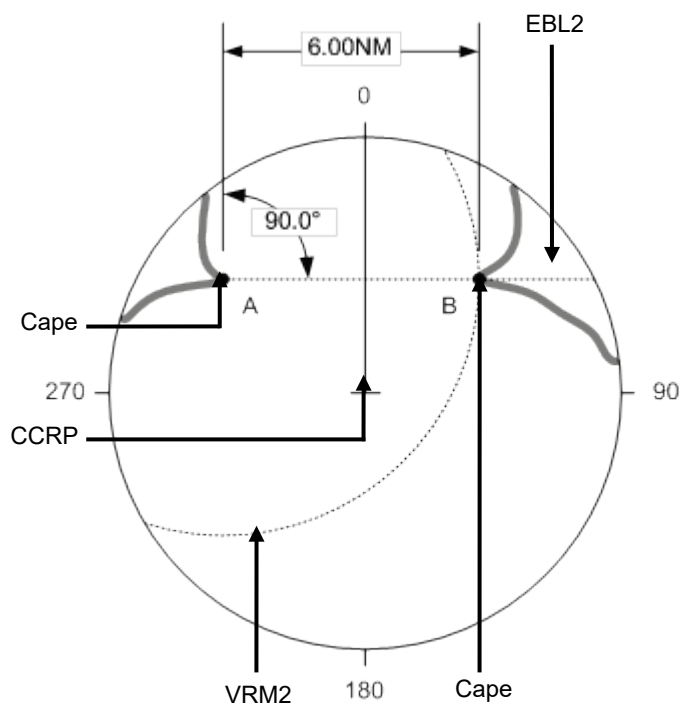

Here, the manipulation with EBL2/VRM2 is explained. The same operation can be performed with EBL1/VRM1.

Memo

To manipulate the EBL/VRM, the RADAR transmission status must be "Transmit".

- 1 Click on the measurement starting point button of EBL2/VRM2 and select [D].



- 2 Align the cursor with “point A” of the two points to be measured and then click it on.
- 3 Enable the movement of EBL2 by clicking on the EBL2 line.
- 4 Align the cursor with bearing “point B” of the two points to be measured and then click it on.
- 5 Enable the manipulation of VRM2 by clicking on the [VRM2] button.



- 6 Move the intersecting point marker on the dotted line of EBL2 by the cursor and align it with point B.

The range and bearing between the two points are displayed.

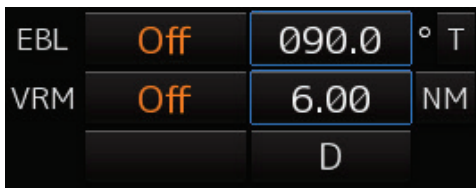

4.6 Using Parallel Index Lines (PI)

4.6.1 Description of a parallel index line

Parallel index lines (PI) refer to straight lines at equal interval that are displayed on the screen.

By using parallel index lines, complicated measurement is enabled relating to the bearing and the range by using the own ship's position as the reference point.

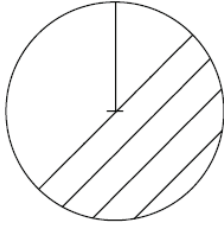

Example of Display

4.6.2 Displaying parallel index lines

4.6.2.1 Displaying parallel index lines by using the [PI] button on the screen

- 1 Click on the [PI] button in Navigation Tools (measuring tool).

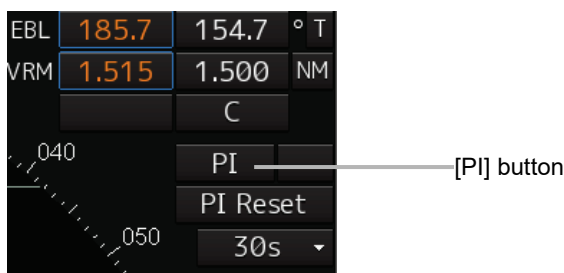

Operation when the [PI] button is clicked on:

- When the [PI] button is set to Off, PI is set to On and the [PI Menu] dialogue is displayed.
- When the [PI] button is set to On and the [PI Menu] dialogue is displayed, the [PI Menu] dialogue is closed. PI remains On.
- When the [PI] button is set to On and the [PI Menu] dialogue is not displayed, PI is set to Off.

Memo

The [PI Menu] dialogue can also be displayed by clicking on [Tools] - [PI] (parallel index lines) on the menu.

- 2 Set PI on the [PI Menu] dialogue.

For the details of the [PI Menu] dialogue, refer to "4.6.2.3 Description of the [PI Menu] dialogue". The [PI Menu] dialogue setting method varies depending on the PI operation mode. For the details, refer to the descriptions of the operation mode in "4.6.3 Setting all the parallel index lines concurrently (All mode)", "4.6.4 Setting parallel index lines individually (Individual mode)", "4.6.5 Displaying lines at equal interval on the left and right sides of the own ship's position (Track mode)", and "4.6.6 Displaying two intersecting lines (Equiangular mode)".

To clear parallel index lines:

- 1 Set the [Display for All Lines] button to Off by clicking on it.

The parallel index lines disappear.

4.6.2.2 Displaying parallel index lines by using the [PI] key on the operation unit

1 Press the [PI] key.

Operation when the [PI] key is pressed:

- When the [Display for All Lines] button is set to Off, PI is set to On and the [PI Menu] dialogue box is displayed.
- When the [Display for All Lines] button is set to On and the [PI Menu] dialogue is displayed, the [PI Menu] dialogue is closed. PI remains On.
- When the [Display for All Lines] button is set to On and the [PI Menu] dialogue is not displayed, PI is set to Off.

2 Set PI on the [PI Menu] dialogue.

For the [PI Menu] dialogue, refer to "4.6.2.3 Description of the [PI Menu] dialogue".

The [PI Menu] dialogue setting method varies according to the PI operation mode. For the details, refer to the description of each operation mode, "4.6.3 Setting all the parallel index lines concurrently (All mode)", "4.6.4 Setting parallel index lines individually (Individual mode)", "4.6.5 Displaying lines at equal interval on the left and right sides of the own ship's position (Track mode)", and "4.6.6 Displaying two intersecting lines (Equiangular mode)".

4.6.2.3 Description of the [PI Menu] dialogue

Memo

Parallel index lines can be operated by using the EBL/VRM dial of the keyboard operation unit only while the [PI Menu] dialogue is displayed. Even if the dialogue is closed, the parallel index lines remain displayed, however, the bearing and interval cannot be operated.

To reset the bearing and the interval, set by redisplaying the [PI Menu] dialogue.

The following items can be set on the [PI Menu] dialogue.

| Display item | Description |
|-----------------------|--|
| Display for All Lines | Use this button to switch display for all parallel index lines to ON/OFF. The button ON/OFF state is maintained even if the dialogue box is closed. The parallel index lines to be displayed are those that have been selected by operating [View] - [Tools] - [PI] on the menu. When the operation mode is [Individual], the parallel index lines that were selected by operating [View] - [Tools] - [PI] (Index Line 1 to Index Line 8) are displayed on the screen. When the operation mode is [Track] or [Equiangular], the parallel index lines that were selected by operating [View] - [Tools] - [PI] (Index Line 1, Index Line 3, Index Line 5, and Index Line 7 correspond to Groups 1, 2, 3, and 4 respectively) are displayed. When the operation mode is All, the line at the centre of the screen becomes Index Line 1 and the parallel index lines from the centre to the outer section correspond to Index Line 2, 3 and so on. |
| Mode | Select an operation mode from among [All], [Individual], [Track], and [Equiangular]. When any operation mode is selected, the dialogue box of the selected operation mode is displayed. |

| Display item | Description |
|---|---|
| Parameter setting area by operation mode | The setting contents that are displayed in this area vary according to the selected operation mode. Set parameters in each operation mode. Refer to "4.6.3 Setting all the parallel index lines concurrently (All mode)", "4.6.4 Setting parallel index lines individually (Individual mode)", "4.6.5 Displaying lines at equal interval on the left and right sides of the own ship's position (Track mode)" and "4.6.6 Displaying two intersecting lines (Equiangular mode)". |
| Floating | Move the centre of the parallel index line. Select the Floating mode from the list. [Off]: Sets the starting point of the parallel index line to the CCRP position. [Screen Fix]: Moves the centre of the parallel index line and fixes it on the screen. [L/L Fix]: Moves the centre of the parallel index line and fixes it based on the latitude and longitude. (Connection of a navigation unit is required.) |
| Heading Link (Heading link setting) | Set whether the parallel index line is linked to the ship's heading. When this item is checked, the parallel index line is linked to the ship's heading. When this item is unchecked, the parallel index line is not linked to the ship's heading. Different values can be set for the angle of the parallel index lines when this item is checked and the angle of the parallel index lines when the item is unchecked. |
| Reference Bearing (Reference bearing selection) | Set a reference bearing of the bearing value display of the parallel index line. This item is not displayed when the mode is [Equiangular]. [True]: Displays the bearing value in true bearing (based on the North). [HL]: Displays the bearing value in the heading line reference. Index Line 1 to Index Line 8: Displays the bearing value by using the Index Line as the reference. (Only when the operation mode is [Individual]) Group 1 to Group 4: Displays the bearing value by using the Group as the reference. (Only when the operation mode is [Track]) |

Switching the Floating mode

When [Screen Fix] or [L/L Fix] is selected in switching the Floating mode, the cursor mode changes.

Memo

When the operation mode is [All] and the reference point that is set in [L/L Fix] moves to the position outside of the PPI circle, the floating mode is set to Off and the own ship's position becomes the reference point.

- When the screen is clicked on, the fixed position or the coordinates on the screen are determined, and the cursor is changed to the normal cursor.
- When [Screen Fix] or [L/L Fix] is re-selected after the determination, the cursor changes to the centre selection cursor for parallel index lines.

4.6.3 Setting all the parallel index lines concurrently (All mode)

When the operation mode is set to [All], all the parallel index lines are operated concurrently. All the lines are in parallel.

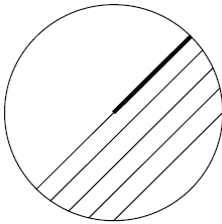

Display Example

- 1 Select [All] from the [Mode] combo box.
- 2 Enter a direction of the parallel index lines in [PI Bearing] (parallel index line bearing).

The setting is applied to the bearings of all the parallel index lines.

Memo

The bearing can also be adjusted by turning the [EBL] dial clockwise/counterclockwise. When the dial is turned clockwise, the bearing is adjusted in the plus direction, and when the dial is turned counterclockwise, the bearing is adjusted in the minus direction. The set value is displayed in the input box.

- 3 Enter a display interval of the parallel index lines in 09. [Interval].

The setting is applied to all the lines.

The input range is the PPI radius when PPI is used as the centre for the lines and double the PPI radius when the PPI is not used as the centre.

Memo

The interval can also be adjusted by turning the [VRM] dial clockwise or anti-clockwise. If the dial is turned clockwise, the interval value increases and if the dial is turned anti-clockwise, the interval value decreases. The set value is displayed in the input box.

Whenever the unit display switching button on the right side of [Interval] is clicked on, the unit (NM/km/sm) of the value displayed is switched.

Memo

NM denotes nautical mile, sm denotes statute mile, and km denotes kilometre.

- 4 Select the area for displaying the parallel index line from the [Operation Area] combo box.

When [One Side] is selected, 8 parallel index lines are displayed on one side of the reference point of own ship or the point set arbitrarily.

When [Both Side] is selected, 15 parallel index lines are displayed on both sides of the reference point of own ship or the point set arbitrarily.

4.6.3.1 Changing the bearing/interval of parallel index lines in the operation unit (All mode)

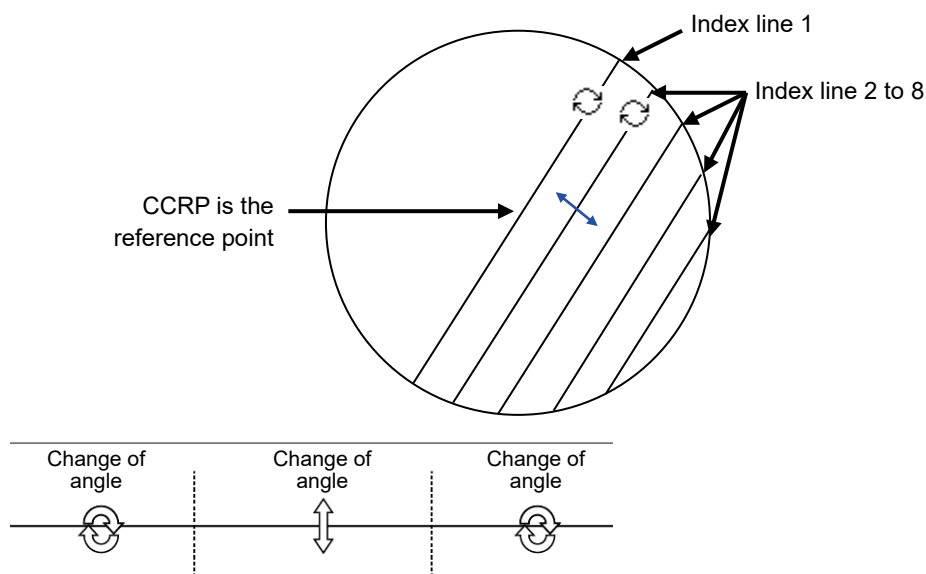

Dividing the line segment that can be clicked into 3 equal sections

[Changing the bearing with index line 1]

When index line 1 is clicked on, the shape of the cursor changes to .

All the index lines rotate centring on the index line reference position (starting point).

[Changing the bearing at a clickable trisectional end segment position of index lines 2 to 8]

When one of the index lines 2 to 8 is divided into three equal segments and the mouse button is clicked on both ends of the line segments, the cursor shape changes to .

Index lines 2 to 8 move, forming a circle centring on the reference position while the index line reference position (starting point) is fixed.

[Changing the interval at a clickable trisectional centre segment position of index lines 2 to 8]

When one of the index lines 2 to 8 is divided into three equal segments and the mouse button is clicked on the middle line segments, the cursor shape changes to .

Index lines 2 to 8 move in parallel to index line 1.

Memo

If a clickable segment is 2 cm or less, the change of interval mode is always activated.

4.6.4 Setting parallel index lines individually (Individual mode)

By setting the operation mode to [Individual], the bearing and the interval of parallel index lines can be set individually.

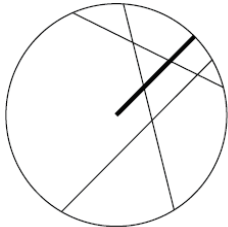

Display Example

- 1 Select [Individual] from the [Mode] combo box.**
- 2 Select a parallel index line (1 to 8) to be set from the [Index Line] combo box**
- 3 Select [Display].**
The selected parallel index line is displayed.
- 4 Enter the bearing of the parallel index line in [PI Bearing].**

Memo

The bearing can also be adjusted by turning the [EBL] dial clockwise/counterclockwise. When the dial is turned clockwise, the bearing is adjusted in the plus direction, and when the dial is turned counterclockwise, the bearing is adjusted in the minus direction. The set value is displayed in the input box.

- 5 Enter the interval of the parallel index line in [Interval].**

The input range is the PPI radius when PPI is used as the centre for the lines and double the PPI radius when the PPI is not used as the centre.

Memo

The interval can also be adjusted by turning the [VRM] dial clockwise or anti-clockwise. If the dial is turned clockwise, the interval value increases and if the dial is turned anti-clockwise, the interval value decreases. The set value is displayed in the input box.

Whenever the 10. unit display switching button on the right side of [Interval] is clicked on, the unit (NM/km/sm) of the numeric value that is displayed is switched.

Memo

NM denotes nautical mile, sm denotes statute mile, and km denotes kilometre.

6 Set 11. [Length L] (length left) and 12. [R] (right).

Adjust the length of the parallel index line by changing the positions of endpoint 1 (Length L) and endpoint 2 (R).

- Define endpoint 1 as the point on the left side when PI centre is viewed from the own ship and endpoint 2 as the point on the right side.

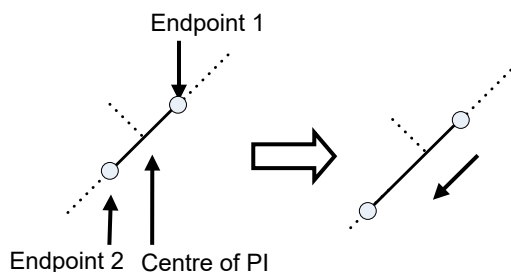

Change the length of endpoint 2

- Set the mode to the endpoint change mode by pressing the [VRM] dial and turn the [VRM] dial to change the position of an endpoint.

Clockwise: + (Direction from the centre of PI to outside)

Counterclockwise: - (Direction towards the centre of PI)

The input range is as follows.

- The minimum length of a parallel index line from the left end to the right end is 2 cm.
- The maximum length is double the PPI radius.

Memo

A negative value can also be set for [Length].

- In the case of the left end, the left direction from the centre becomes a positive value and the right direction from the centre becomes a negative value.
- In the case of the right end, the right direction from the centre becomes a positive value and the left direction from the centre becomes a negative value.

Whenever the unit display switching button on the right side of [length] is clicked on, the unit (NM/km/sm) of the numeric value that is displayed is switched.

Memo

NM denotes nautical mile, sm denotes statute mile, and km denotes kilometre.

Setting parallel index lines consecutively

When [Sequential] is checked and [Screen Fix] or [L/L Fix] is selected at floating mode switching, the parallel index lines to be set are changed in the sequence of Index Line 1→2→...→8→1... and setting can be performed consecutively.

Memo

The index lines that are set to be hidden by selecting [View] - [Tools] on the menu are skipped during operation.

4.6.4.1 Changing the bearing/interval/end point of parallel index lines in the trackball operation unit (Individual mode)

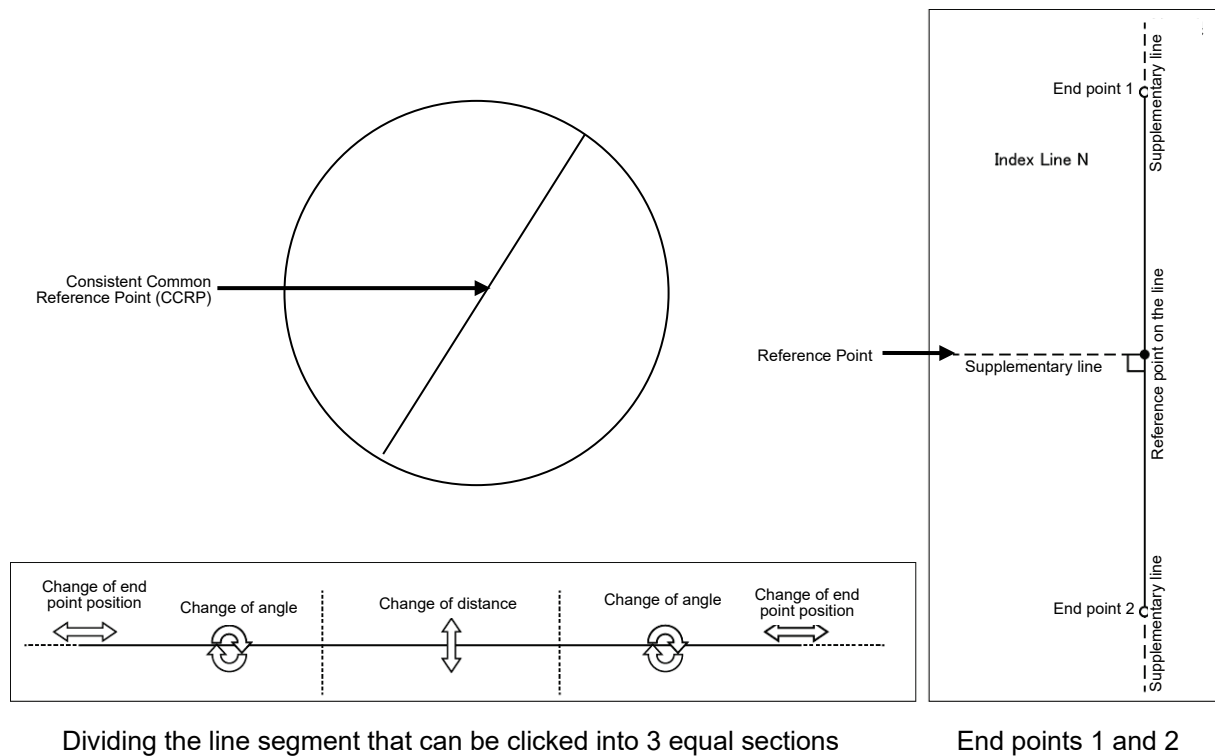

[Changing the bearing at a clickable trisectional segment position on both sides]

- 1 Place the cursor on the lines on both sides of the lines that were created by dividing one of the index lines 1 to 8, which can be clicked, into 3 equal sections and click the button.**
The shape of the cursor changes to  and when the mouse button is clicked, the bearing of the parallel index lines can be changed.
- 2 Move the cursor to the bearing to be set.**
The bearing of the parallel index lines changes together with the cursor.
- 3 Click the mouse button.**
The parallel index lines are fixed.

[Changing the distance at a clickable trisectional middle position]

- 1 Place the cursor on the middle line of the lines that were created by dividing one of the index lines 1 to 8, which can be clicked, into 3 equal sections and click the button.**
The shape of the cursor changes to  and when the mouse button is clicked, the interval of the parallel index lines can be changed.
- 2 Move the cursor to the interval to be set.**
The interval of the parallel index lines changes together with the cursor.
- 3 Click the mouse button.**
The parallel index lines are fixed.

Memo

If a clickable segment is 2 cm or less, the change of interval mode is always activated.

[Changing the positions of end points 1 and 2]

- 1 Set the cursor on the broken-line display section on the end point side to be moved on one of the index lines 1 to 8.**

The shape of the cursor changes to  and when the mouse button is clicked, the position of end point 1 or end point 2 can be changed.

- 2 Move the cursor to the bearing to be set.**

The position of end point 1 or 2 changes together with the cursor.

- 3 Click the mouse button.**

The position of end point 1 or 2 is fixed.

4.6.5 Displaying lines at equal interval on the left and right sides of the own ship's position (Track mode)

When the operation mode is set to [Track], lines are displayed on both the left and right sides at equal intervals.

Display Example

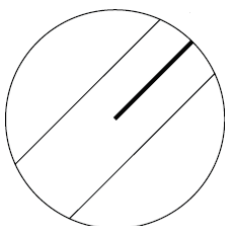

- 1 Select [Track] from the [Mode] combo box.**
- 2 Select a parallel line cursor group (1 to 4) from the [Group] combo box.**
Since in [Track] mode, parallel index lines always form pairs, set in group units.
- 3 Select [Display].**
The selected parallel line cursor group is displayed.
- 4 Enter the bearing of the parallel index line group in [PI Bearing].**

Memo

The bearing can also be adjusted by turning the [EBL] dial clockwise/counterclockwise. When the dial is turned clockwise, the bearing is adjusted in the plus direction, and when the dial is turned counterclockwise, the bearing is adjusted in the minus direction. The set value is displayed in the input box.

- 5 Enter the interval of the parallel index line group in [Interval].**

The input range is the PPI radius when PPI is used as the centre for the lines and double the PPI radius when the PPI is not used as the centre.

Memo

The interval can also be adjusted by turning the [VRM] dial clockwise or anti-clockwise. If the dial is turned clockwise, the interval value increases and if the dial is turned anti-clockwise, the interval value decreases. The set value is displayed in the input box.

Whenever the unit display switching button on the right side of [Interval] is clicked on, the unit (NM/km/sm) of the numeric value that is displayed is switched.

Memo

NM denotes nautical mile, sm denotes statute mile, and km denotes kilometre.

4.6.5.1 Changing the bearing/interval of parallel index lines with the trackball (Track mode)

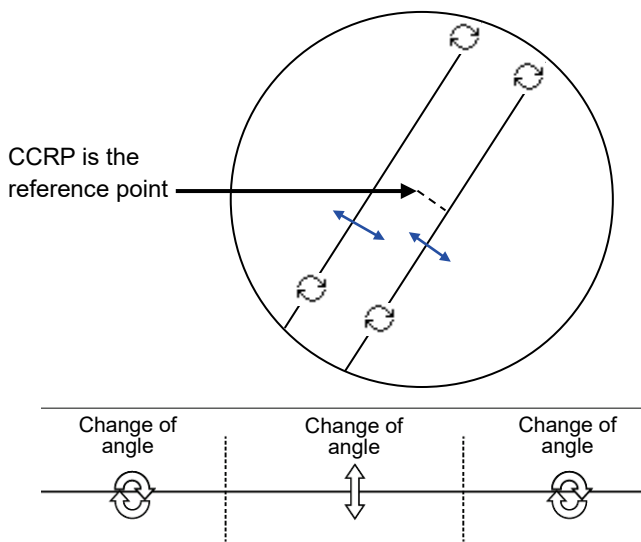

Dividing the line segment that can be clicked into 3 equal sections

[Changing the bearing at a clickable trisectional end segment position]

- 1 Place the cursor on the lines on both sides of the lines that were created by dividing one of the index lines 1 to 8, which can be clicked, into 3 equal sections and click the button.**
The shape of the cursor changes to  and when the mouse button is clicked, the bearing of the parallel index lines can be changed.
- 2 Move the cursor to the bearing to be set.**
The bearing of the parallel index lines changes together with the cursor.
- 3 Click the mouse button.**
The parallel index lines are fixed.

[Changing the distance at a clickable trisectional middle position]

- 1 Place the cursor on the middle line of the lines that were created by dividing one of the index lines 1 to 8, which can be clicked, into 3 equal sections and click the button.**
The shape of the cursor changes to  and when the mouse button is clicked, the interval of the parallel index lines can be changed.
- 2 Move the cursor to the interval to be set.**
The interval of the parallel index lines changes together with the cursor.
- 3 Click the mouse button.**
The parallel index lines are fixed.

4.6.6 Displaying two intersecting lines (Equiangular mode)

When the operation mode is set to [Equiangular], two intersecting lines are displayed.

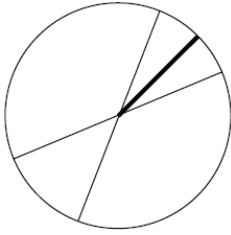

Display Example

- 1 Select [Equiangular] from the [Mode] combo box.**
- 2 Select a parallel index line group (1 to 4) from the [Group].**
Since parallel index lines form pairs in [Equiangular] mode, set in group units.
- 3 Select [Display].**
The selected parallel line cursor group is displayed.
- 4 Enter the bearing of the parallel index line group in [PI Bearing] (parallel index line bearing adjustment).**

Memo

The bearing can also be adjusted by turning the [EBL] dial clockwise/counterclockwise. When the dial is turned clockwise, the bearing is adjusted in the plus direction, and when the dial is turned counterclockwise, the bearing is adjusted in the minus direction.

The set value is displayed in the input box.

- 5 Enter the vertical angle of the parallel index line group in [Vertical Angle] (vertical angle).**

4.6.6.1 Changing the bearing of two intersecting lines in the trackball (Equiangular mode)

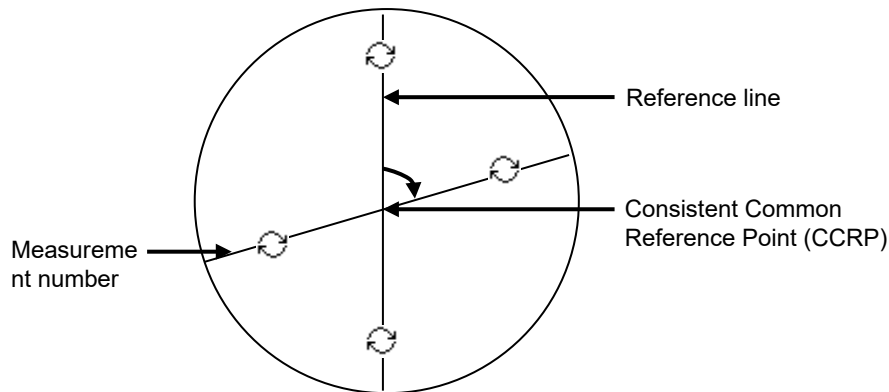

[Changing the bearing of index lines 1 to 8]

- 1 Place the cursor on index lines 1 to 8 and click the mouse button.**
The shape of the cursor changes to  and when the mouse button is clicked, the bearing of the two intersecting lines can be changed.
- 2 Move the cursor to the bearing to be set.**
The bearing of the two intersecting lines changes together with the cursor.
- 3 Click the mouse button.**
The two intersecting lines are fixed.

4.6.7 Setting parallel index lines in the operation unit

The bearing and interval of parallel index lines can be set with the [EBL] and [VRM] dials.

- 1 Press the [PI] key to display the [PI Menu] dialogue box.**
- 2 By turning the [EBL] dial, set up bearing.**
Turning the [EBL] dial to the right changes the bearing of parallel index lines in the right bearing [1] and turning it to the left changes in the left bearing [2].
- 3 By turning the [VRM] dial, set up the interval of parallel index lines.**
Turning the [VRM] dial to the left narrows the interval of parallel index lines [3] and turning it to the right widens the interval [4].

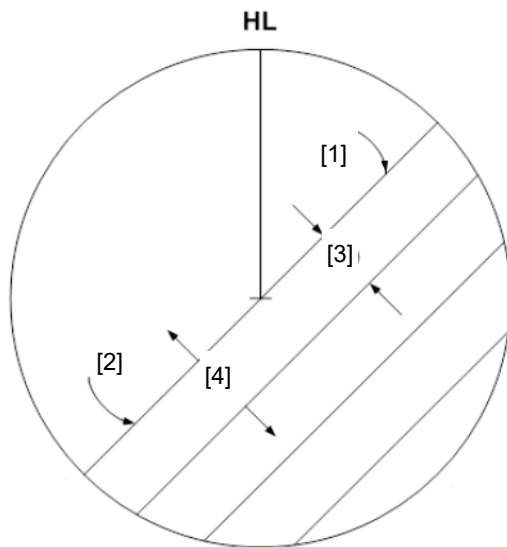

- 4 Press the [PI] key to close the [PI Menu] dialogue box.**
The parallel index lines are fixed.

The operation and motion of the parallel index differ depending on the motion mode in the [PI Menu] dialogue.

4.6.7.1 Operation in [All] mode

[Operating the [EBL] dial]

By using the [EBL] dial, the bearing of the index lines can be changed.

[Operating the [VRM] dial]

By using the [VRM] dial, the interval of the index lines can be changed.

4.6.7.2 Operation in [Individual] mode

In [Individual] mode, the index line that is selected in the [Index Line] combo box is operated.

[Using the [EBL] dial]

By using the [EBL] dial, the bearing of the index line can be changed.

Setting parallel index lines consecutively by using the [EBL] dial

When [Sequential] is checked, the floating mode is set. When [Screen Fix] or [L/L Fix] is selected, the parallel index line to be set is switched in the sequence of Index Line1→2→...→8→1..., enabling consecutive setting.

Memo

The index lines that are set to be hidden by selecting [View] - [Tools] on the menu are skipped during operation.

[Operating the [VRM] dial]

By using the [VRM] dial, the interval of the index lines can be changed.

The reference point for changing the interval can be an end point 1 or 2 of the index line or the reference point on the line.

Whenever the [VRM] dial is pressed, the reference point is selected in the sequence of "end point 1→end point 2→reference point on the line→..."

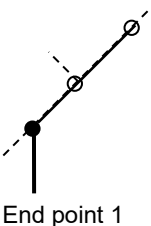
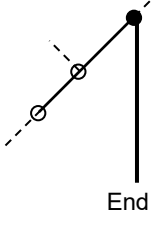
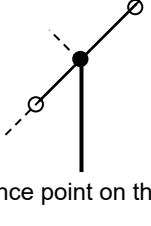
| End point 1 | End point 2 | Reference point on the line |
|---|---|--|
|  <p>End point 1</p> |  <p>End point 2</p> |  <p>Reference point on the line</p> |
| As a result of the selection, the distance from the reference point to the end point 1 on the line changes. | As a result of the selection, the distance from the reference point to the end point 2 on the line changes. | As a result of selection, the interval from the reference point to the index line changes. |

4.6.7.3 Operation in [Track] mode

The index lines of the group that is selected in [Group] combo box are operated in [Track] mode.

[Operating the [EBL] dial]

By using the [EBL] dial, the bearing of the index lines can be changed.

[Operating the [VRM] dial]

By using the [VRM] dial, the interval of the index lines can be changed.

4.6.7.4 Operation in [Equiangular] mode

The index lines of the group that is selected in [Group] combo box are operated in [Equiangular] mode.

[Operating the [EBL] dial]

By pressing the [EBL] dial, the "Group reference line (PI Bearing)" and the "Group measurement line" can be set.

Whenever the [EBL] dial is pressed, the "Group reference line (PI Bearing)" and the "Group measurement line" are selected alternately.

Memo

A measurement line can be set across the reference line. (When a measurement line is set across the reference line by rotating the dial in the minus direction, the measured bearing data changes as $0^{\circ} \rightarrow 359.9^{\circ}$.)

When the reference line is set by using the EBL dial, the value of the measured bearing data is maintained and the measurement line follows concurrently.

[Operation the [VRM] dial]

In [Equiangular] mode, the [VRM] dial is disabled.

4.7 Using the EBL Manoeuvre

The EBL Manoeuvre is the function that displays a predictable track when own ship is turned under certain conditions.

By displaying a manoeuvre curve that has been drawn by taking safety into consideration, it can be used as the guideline for turning.

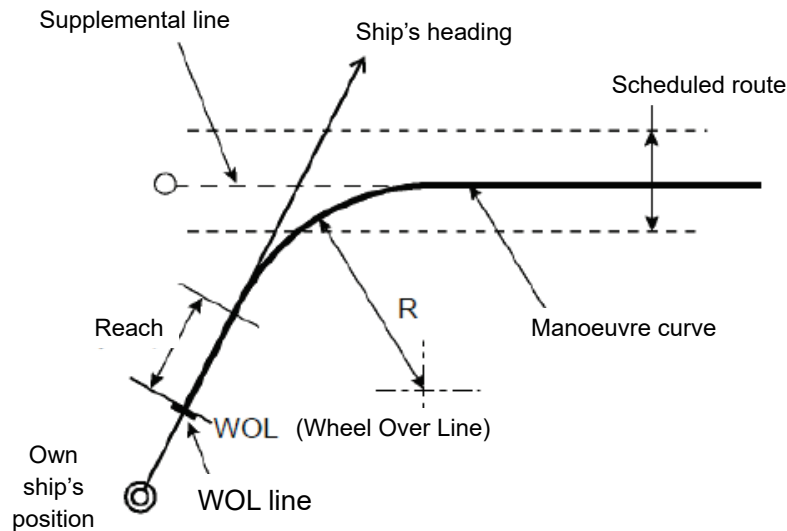

[Operation procedure]

Perform the following menu operation to open the EBL Manoeuvre Setting screen.

[Menu] button → Tools → EBL Manoeuvre

4.7.1 Setting the creation conditions of the EBL Manoeuvre

The table below shows the EBL Manoeuvre creation condition setting items.

| Setting item | Contents |
|--|---|
| Display Manoeuvre curve | Switches the manoeuvre curve creation mode to On/Off. When this item is set to Off, the manoeuvre curve is hidden. |
| Course T (True bearing) | The bearing of the acquisition line is displayed in true bearing. The line can also be set. The input range is from 0.0 to 359.9°. |
| R (Relative bearing) | The bearing of the acquisition line is displayed in relative bearing. |
| Reach | The distance (reach) from steering to turning is displayed. The line can also be set. The input range is from 0 to 2000 m (integer value). |
| Turn set (Turning mode) | Select a turning mode from either 04. [Radius] or 05. [Rate]. |
| Radius (Constant turn radius) | Set a constant turn radius to be used for the turn mode. The input range is from 0.10 to 9.99 NM. |
| Rate (Constant turn rate) | Set a constant turn speed to be used in turn mode. The input range is from 20.0 to 720°/min. |
| WOL (Distance to WOL) | The distance up to WOL is displayed. |
| TTG (Expected traveling time to reach WOL) | The expected traveling time to reach WOL is displayed. When the ship's speed is 0 or the speed information of the own ship is invalid and the TTG value is invalid, "***h**m**s" is displayed. |

4.7.2 Creating an EBL manoeuvre curve

1 Set the function to [ON] by clicking on the [Display Manoeuvre curve] button.

A supplemental line, a manoeuvre curve, and a WOL for creating a manoeuvre curve are displayed and the manoeuvre curve creation mode is set.

The bearing of the supplementary line can be changed by turning the EBL dial during creation of a manoeuvre curve.

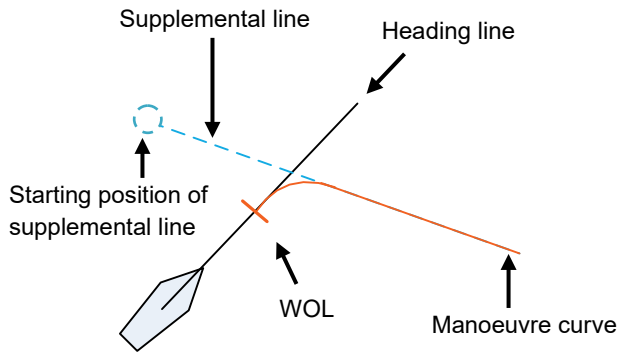

2 Determine a supplemental line starting position by clicking.

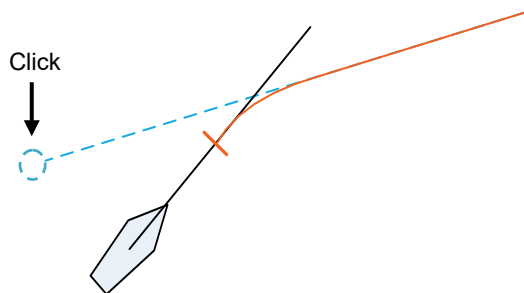

Memo

When the WOL position is behind the own ship, the colour of WOL changes to red and the supplemental line starting point can no longer be determined by clicking on the point.

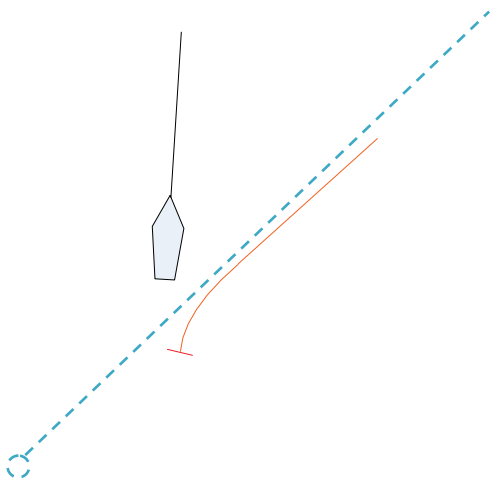

labelling="Section-Header">Cancelling the creation of manoeuvre curve

When you right-click in manoeuvre curve creation mode, the creation can be cancelled.

4.8 Offsetting the Own Ship's Position Manually (Position Offset Function of Manual position fix)

WARNING



Do not use the offset function during the voyage.

If the function is used while an offset value is input in the own ship's position (different from the actual position), an accident may occur.

4.8.1 [Position Offset] tab of the [Manual position fix] dialogue box

[Operation procedure]

Perform the following menu operation to open the [Position Offset] tab of the [Manual Position Fix] dialogue.

[Menu] button → Tools → Manual Position Fix → Position Offset tab

The following items are displayed.

| Display item | Description |
|-------------------|--|
| Position | |
| Offset | The offset amount that was set by [Enter Offset] and [Enter Position] is displayed. |
| Clear Offset | The offset value is cleared. |
| Enter Offset... | This button displays the [Enter Offset] dialogue box. For the details, refer to "4.8.2 Setting the offset amount that is input in the [Enter Offset] dialogue as the offset position". |
| Enter Position... | This button displays the [Enter Position] dialogue box. For the details, refer to "4.8.3 Setting the position on the chart on which the mouse button was clicked as the offset position". |

4.8.2 Setting the offset amount that is input in the [Enter Offset] dialogue as the offset position

- 1** Click on the [Enter Offset] button of [Position].
The [Enter Offset] dialogue is displayed.
- 2** Select Input box, then use the displayed software keyboard to enter an offset amount of the latitude.
- 3** Select Input box, then use the displayed software keyboard to enter an offset amount of the longitude.
- 4** Click on the [OK] button.
The offset amount that was input is set as the offset position.

4.8.3 Setting the position on the chart on which the mouse button was clicked as the offset position

- 1** Click on the [Enter Position] button of [Position].
The [Enter Position] dialogue is displayed.
While the dialogue is displayed, the cursor changes to the offset cursor and the mode changes to the position selection mode.
- 2** The position is displayed in [Position] in the dialogue as the coordinate of the position on the chart on which the mouse button was clicked.

Memo

Post-offset coordinates can also be input from the software keyboard.

- 3** Click on the [OK] button.
The coordinate is set in the offset position.

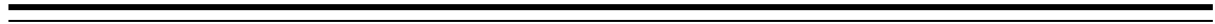

Section 5 Basic Operation of the Radar

CAUTION



Use the radar as your navigation aid.

Final decision on the ship operation must be made by the ship operator himself.

If you depend entirely on the radar information for the final decision on the ship operation, such an accident as collision and stranding may occur.



If momentary power interruption has occurred on the ship during the radar operation, the image may distort or may not appear. If this occurs, turn on the power again.

5.1 Overview Flowchart

CAUTION



- Do not put anything on the operation section.
In particular, if a hot object is placed on the operation section, deformation is likely to occur.
- Do not allow a heavy impact to be applied to the operation section, trackball or dial. A trouble may occur.

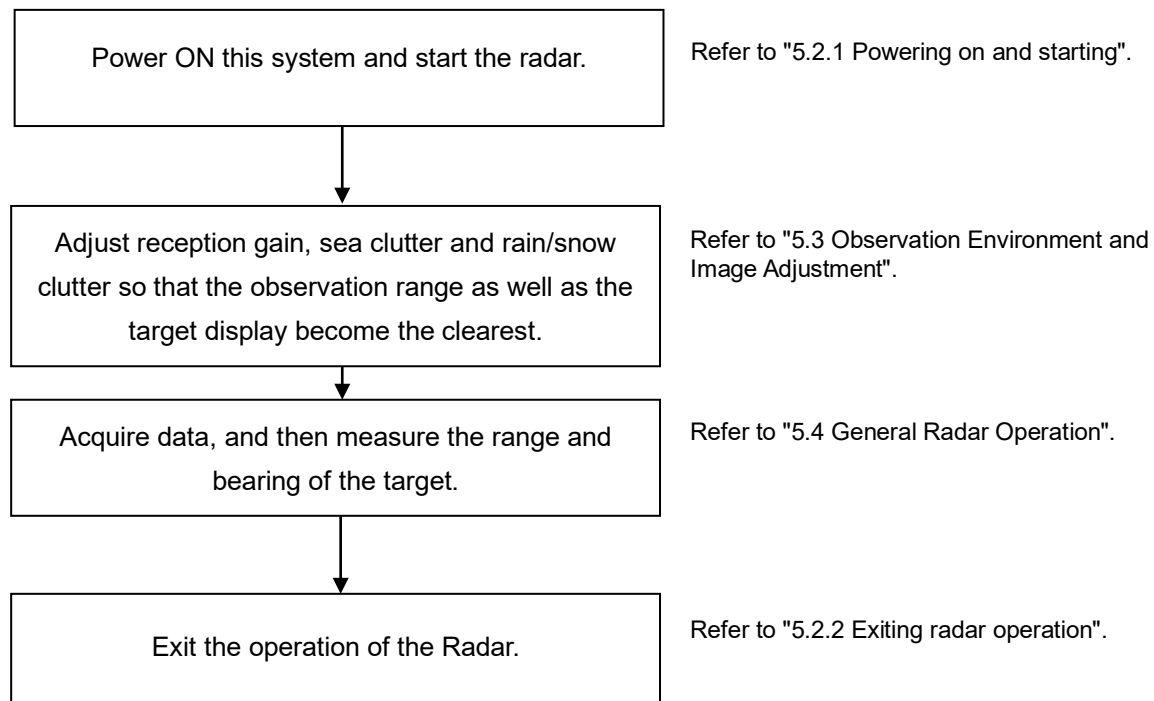

5.2 Starting and Shutting Down the Radar

5.2.1 Powering on and starting

Memo

- Wait for about 2 seconds before turning on the power again.
- Immediately after the radar is installed, at start of the system after it has not been used for a long time, or after the magnetron is replaced, preheat the equipment in the standby state for 20 to 30 minutes before setting it into the transmit state.
If the preheating time is short, the magnetron causes sparks, resulting in its unstable oscillation.
- Start transmission on a short pulse range and change the range to the long pulse ranges in turn. If the transmission is unstable in the meantime, immediately place the system back into the standby state and maintain it in the standby state for 5 to 10 minutes before restarting the operation. Repeat these steps until the operation are stabilised.
- Even if the Standby/Transmit switch button is clicked on while "Preheat" is being displayed, radar transmission cannot be performed.

1 Check that the ship's mains are turned on.

2 Press the Power button on the operation unit.

This equipment starts and a Mode Selection screen is displayed.

3 Click on the [RADAR] button on the Mode Selection screen.

The RADAR screen appears.

The preheating time is displayed at the centre of the screen.

When the magnetron radar antenna is connected, "Preheat" is displayed on the Standby/Send switching button.

4 Wait until preheating is complete.

When the preheating time expires, the preheating time display disappears, and the display of the Standby/Transmit switch button changes from "Preheat" to "Standby".

5 Click on the Standby/Transmit switch button.

Radar transmission starts and the radar antenna rotates.

The display of the Standby/Transmit switch button changes from "Standby" to "Transmit".

5.2.2 Exiting radar operation

1 Click on the Standby/Transmit switch button in Radar system information.

Radar transmission stops and the rotation of the radar antenna stops.

The display of the Standby/Transmit switch button changes from "Transmit" to "Standby".

Memo

If observation using the radar is being scheduled within a comparably short period of time, keep this state. Observation can be started immediately by just clicking on the Standby/Transmit switch button.

2 Press the Power button on the operation unit.

The power to this equipment is turned OFF.

WARNING



When turning off the power supply, do not hold down the power button of the operation unit.

Otherwise, a trouble may occur due to termination failure.



Before starting maintenance, turn off power. Cut off all the power supplies to the equipment.

Some equipment components can carry electrical current even after the power switch is turned off, and conducting maintenance work may result in electric shock, equipment failure, or accidents.

5.3 Observation Environment and Image Adjustment

5.3.1 Adjusting screen brightness

1 Adjust the screen brightness.

For the details of the adjustment, refer to "3.9 Adjusting the Brightness of the Screen and Operation Unit". In consideration of the ambient brightness, adjust the brightness of the display that is high enough to easily observe the radar display but does not glare.

5.3.2 Changing the observation range

1 Click on the [Range Scale] button in Range and mode information and select a range from the context menu.

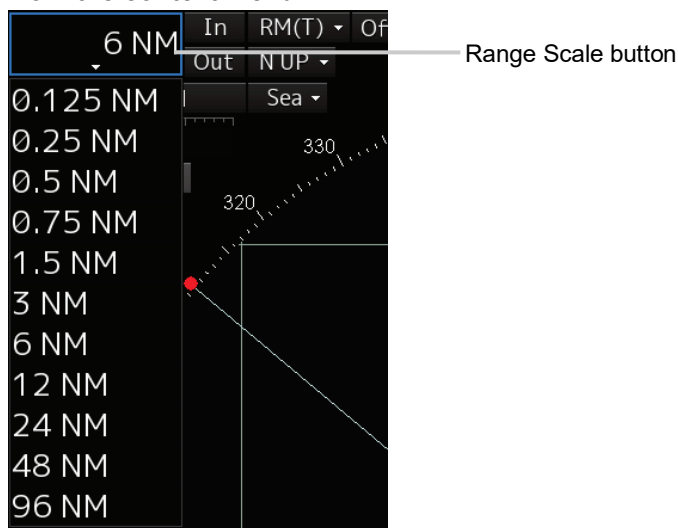

[Points on adjustments]

Increasing the observation range will enable a wider range to be observed.

However, a video image is small and the ability to detect targets near own ship decreases. Therefore, when observing the vicinity of own ship, use the smaller observation range.

Decreasing the observation range will enable the vicinity of own ship to be enlarged. However, caution must be taken because video images of the area beyond the observation range cannot be displayed.

CAUTION



Since the image within the previous observation range is displayed by expanding/contracting for the period from immediately after switching of the observation range from the next image updating, do not use this image for navigation.

If this image is used for navigation, an accident may occur.

Memo

An observation range under which the own ship display position and the antenna position exceeds the area 75% of the screen radius cannot be selected.

5.3.3 Adjusting tune

CAUTION



Normally, use the automatic tune mode.

If you use the manual tuning mode, an accident may be caused by fluctuation of transmission and reception.

Use the manual tune mode only when best tuning is not possible in the automatic tune mode due to deterioration of magnetron.

This equipment has the automatic tuning mode that performs tuning of the transmission frequency and the reception frequency by automatic control, and the manual tuning mode in which the user performs tuning. Normally use the automatic tune mode. Only when the best tuning is not possible by the automatic tune mode due to the deterioration of magnetron, use the manual tune mode.

The tuning mode currently being used is displayed on the Tuning Mode button in Radar system information.

Memo

This function is effective when a magnetron radar antenna is connected.

When using the automatic tune mode

1 Click on the tune mode button.

[AUTO] (automatic) is displayed on the tune mode button.

Whenever the button is clicked on, the mode is switched between [AUTO] (automatic) and [MAN] (manual).

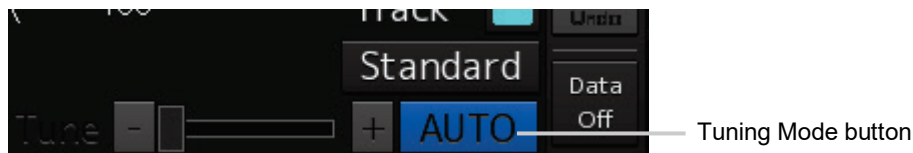

Using the manual tune mode

1 Click on the tune mode button.

[MAN] (manual) is displayed on the tune mode button. Each time this button is clicked on, the display switches between [AUTO] (automatic) and [MAN] (manual).

2 Move the fine tuning slider to the left and right sides.

The tuning status is displayed on the tuning bar according to the movement of the fine tuning slider. Make adjustments so that the display on the tuning bar indicates the maximum (the state in which the tuning bar is positioned at the most right).

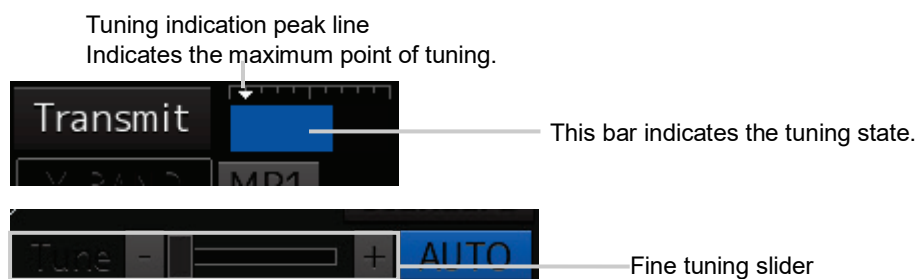

5.3.4 Adjusting gain

⚠ CAUTION



Be sure to always adjust for the best gain.

If the gain is too high, undesired signals including receiver noise and false echoes increase resulting in reduction of visibility of targets. Otherwise, accidents may result. On the contrary, if the gain is too low, targets including ships and dangerous objects may not be clearly indicated.

Adjust the gain of the radar.

Memo

Set the optimum gain when making adjustments, giving consideration to the setting described in "5.3.7 Adjusting to optimal images (Selection of observation scenes)".

- 1 Drag the [Gain] (reception gain adjustment) slider dial in Radar signal information, turn the trackball, and set up reception gain.

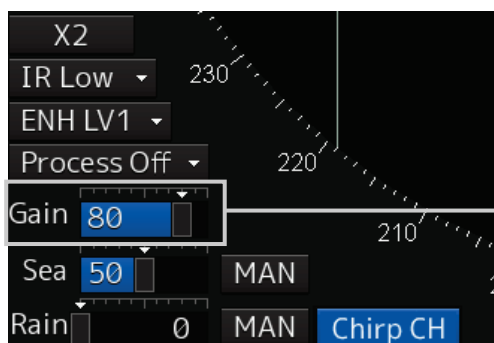

[Gain] (reception gain adjustment) slider

Moving the slider to the right increases gain.

Moving the slider to the left decreases gain.

The current reception gain level is indicated by the bar and a numeric value.



Current reception gain

[Points on adjustments]

As reception gain is increased, the range in which radar images can be observed widens; however, if gain is increased too high, receiver noise, false echoes and other undesired signals will increase on the screen, lowering the visibility of targets.

Also, it gets easier to see the screen display if gain is decreased to observe cluttered targets and close range, but be careful not to overlook small targets.

Memo

If the optimal setting value was lost, it is recommended to reset to the initial value and tune up again.

The initial setting value is indicated as shown in the figure at right.

Initial setting value



5.3.5 Rejecting sea clutter (Sea)

WARNING



Never set the sea clutter suppression function before rejecting all the sea clutters at close range. Detection of not only echoes from the wave and so on but also targets such as other ships or dangerous objects may be suppressed.

When using the sea clutter suppression function, make sure to choose the most appropriate setting for suppression.

Memo

Remove images by sea clutter by using the sea clutter suppression function.

When using the sea clutter suppression function, make the optimum setting, giving considering to the setting described in "5.3.7 Adjusting to optimal images (Selection of observation scenes)".

- 1 Drag the [Sea] (sea clutter adjustment) slider dial in Radar signal information, turn the trackball, and adjust the amount of images by sea clutter displayed on the screen so as to make display easy to observe.**

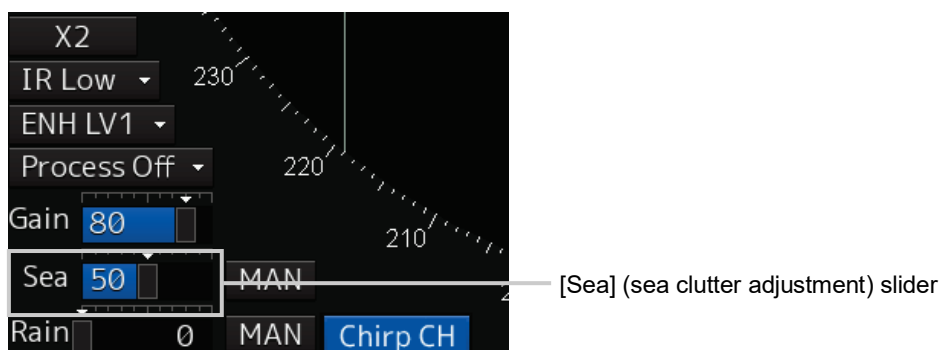

Moving the slider to the right decreases the amount of images by sea clutter.

Moving the slider to the left increases the amount of images by sea clutter.

The current level of sea clutter suppression is indicated by the bar and a numeric value.

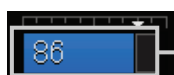

Current level of sea clutter suppression

[Points on adjustments]

The sea clutter suppression function decreases the amount of images by sea clutter by lowering reception gain at close range. When reception gain is lowered, the effectiveness of sea clutter suppression increases; however, if excessive effect is applied, please note that targets having weak signal strength such as buoys and small ships will disappear.

Memo

If the optimal setting value was lost, it is recommended to reset to the initial value and tune up again.

The initial setting value is indicated as shown in the figure at right.

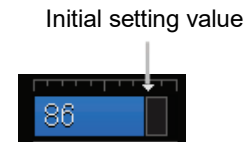

Using the function of automatic sea clutter suppression mode

The sea clutter suppression in accordance with the intensity of sea clutter is possible. Use this mode when the sea clutter's intensity differs according to directional orientation.

1 Click on the Automatic Sea Clutter Suppression button.

[AUTO] (automatic) is displayed on the automatic sea clutter suppression button.

Each time this button is clicked on, the display switches between [AUTO] (automatic) and [MAN] (manual).

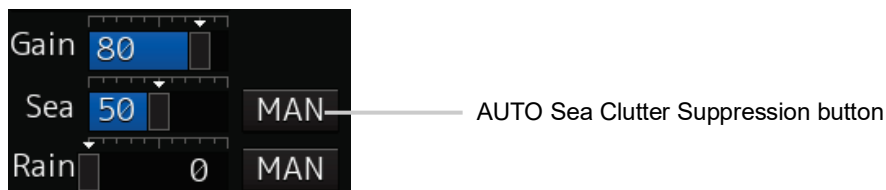

2 Drag the sea clutter adjustment slider dial, turn the trackball, and adjust the amount of images by sea clutter displayed on the screen.

Even while automatic sea clutter is being suppressed, the amount of images can be fine-adjusted manually.

Canceling automatic sea clutter suppression

1 Click on the Automatic Sea Clutter Suppression button.

[MAN] (manual) is displayed on the automatic sea clutter suppression button.

Each time this button is clicked on, the display switches between [AUTO] (automatic) and [MAN] (manual).

5.3.6 Rejecting rain/snow clutter

WARNING



Never set the rain/snow clutter suppression function too high.

Detection of not only echoes from the rain or snow but also images targets such as other ships or dangerous objects may be suppressed.

When using the rain/snow clutter suppression function, make sure to choose the most appropriate setting for suppression.

Memo

Remove images by rain/snow clutter by using the sea clutter suppression function.

When using the rain/snow clutter suppression function, make the optimum setting giving considering to the setting described in "5.3.7 Adjusting to optimal images (Selection of observation scenes)".

- 1 Drag the [Rain] rain/snow clutter adjustment slider dial in Radar signal information, turn the trackball, and adjust the amount of images by rain/snow clutter displayed on the screen so as to make display easy to observe.



[Rain] (rain/snow clutter adjustment) slider

Moving the slider to the right decreases the amount of images by rain/snow clutter.

Moving the slider to the left increases the amount of images by rain/snow clutter.

The current level of rain/snow clutter suppression is indicated by the bar and a numeric value.



Current level of rain/snow clutter suppression

[Points on adjustments]

When the amount of images by rain/snow clutter is decreased, the outlines of targets hidden by images of rain/snow will appear, but please note that small targets may be missed. Since this can also reduce sea clutter, it is effective to use it together with the sea clutter rejection function.

Normally, set the level of rain/snow clutter suppression to 0.

Memo

If the optimal setting value was lost, it is recommended to reset to the initial value and tune up again.

The initial setting value is indicated as shown in the figure at right.

Initial setting value



Using the automatic rain/snow clutter suppression mode

The rain/snow clutter suppression in accordance with the intensity of rain/snow clutter is possible. Use this mode when the rain/snow clutter's intensity differs according to directional orientation.

- 1 Click on the Automatic Rain/Snow Clutter Suppression button.

[AUTO] (automatic) is displayed on the automatic rain/snow clutter suppression button.

Each time this button is clicked on, the display switches between [AUTO] (automatic) and [MAN] (manual).

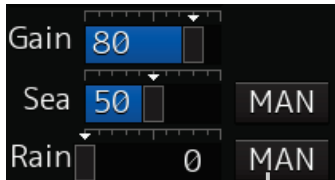

AUTO Rain/Snow Clutter Suppression button

- 2 Click the left mouse button of the button on the [Rain] (rain/snow clutter adjustment) slider, drag it with the trackball, and adjust the volume of the echo created by rain/snow clutter that is displayed on the screen.

Even while AUTO rain/snow clutter is being suppressed, the amount of images can be fine-adjusted manually.

Canceling automatic rain/snow clutter suppression

- 1 Click on the Automatic Rain/Snow Clutter Suppression button.

[MAN] (manual) is displayed on the automatic rain/snow clutter suppression button.

Each time this button is clicked on, the display switches between [AUTO] (automatic) and [MAN] (manual).

5.3.7 Adjusting to optimal images (Selection of observation scenes)

To obtain optimal images, it is necessary to understand the features of radar signal processing settings and perform adjustment according to the sea condition. When adjusting all setting values manually, such adjustment may sometimes difficult even for experienced operators.

Thus, signal processing settings suitable for general usage are preset in the observation scene selection function at the time of factory shipment. In many cases, optimal images can be obtained quickly by selecting the observation scene corresponding to the current sea condition.

- 1 Click on the **Observation Scene Selection** button at the bottom of the **Top** screen.

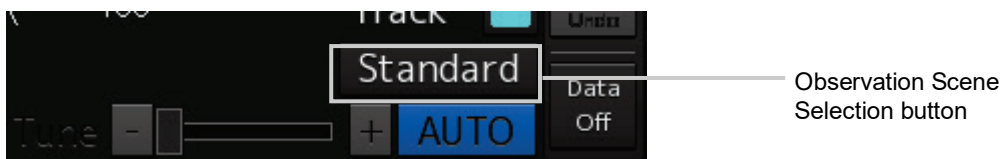

The [Observation Scene Selection] dialogue is displayed.

- 2 Select the **observation scene corresponding to the current sea condition**

Refer to the following table about the definitions of observation scene.

Memo

Some items are not displayed according to the equipment setting differences.

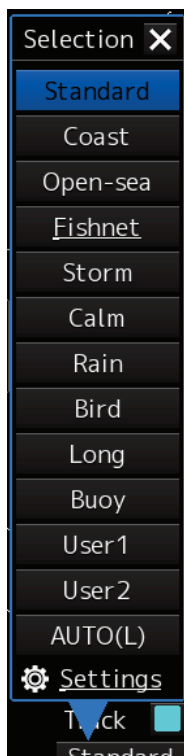

| Observation Scene | Definition |
|-------------------|---|
| Standard | Standard |
| Coast | Coastal fishing Use this scene to monitor a relatively short range, for example, bays and coasts where many boats and ships are running. (Importance is attached to resolution.) |
| Open-sea | Open-sea navigation Use this scene to monitor a relatively long range, for example, the open-sea. (Importance is attached to long range gain) |
| Fishnet | Fishnet Use this scene to detect small targets such as fishnets of round haul netters hidden by sea clutter returns. (Importance is attached to sea clutter suppression, and gain to moving targets lowers.) |
| Storm | Storm Use this scene when many rain/snow clutters or sea clutter are detected in stormy weather. (Importance is attached to rain/snow clutter and sea clutter suppression, and gain slightly lowers.) |
| Calm | Calm Use this scene when only a few rain/snow clutter or sea clutter are detected. |
| Rain | Rain Use this scene when sea clutter is not strong but rain/snow clutter is strong. (Importance is attached to rain/snow clutter suppression, and gain slightly lowers.) |
| Bird | Bird Use this scene to detect a flock of sea birds. |
| Long | Long distance detection Use this scene to monitor utmost distances in the broad ocean. |
| Buoy | Buoy Use this scene to detect small targets such as radio buoys outside of sea clutter. (Targets having low detection probability are displayed.) |
| User1 | User 1 General scene used when the nine scenes above are not applicable. |
| User2 | User 2 General scene used when the nine scenes above are not applicable. |
| AUTO (L) | Automatic The scene is automatically switched to the observation scene that is set according to the selected range. For the setting method, refer to "13.4 Observation Scene Common Setting". |

3 Adjust [Gain], [Sea] and [Rain] as necessary.

Memo

- When the setting value among the observation scene is changed from the initial value, underline is displayed for the observation scene selection button and a button corresponding to the [Selection] (observation scene selection) dialogue is displayed.
- If the optimal setting value was lost, it is recommended to reset to the initial value and tune up again.

The initial setting value is indicated as shown in the figure at right.

Initial setting value



5.4 General Radar Operation

5.4.1 Interference Rejection (IR function)

By setting IR (Interference Rejection) function, Interference by other radars is rejected.

Memo

To observe the radar beacon and the SART signal, IR processing may occasionally suppress these images, so set IR to Off (interference rejection function OFF).

- 1 Select an interference rejection effect level from the [IR] (Interference Rejection) combo box of Radar signal information.

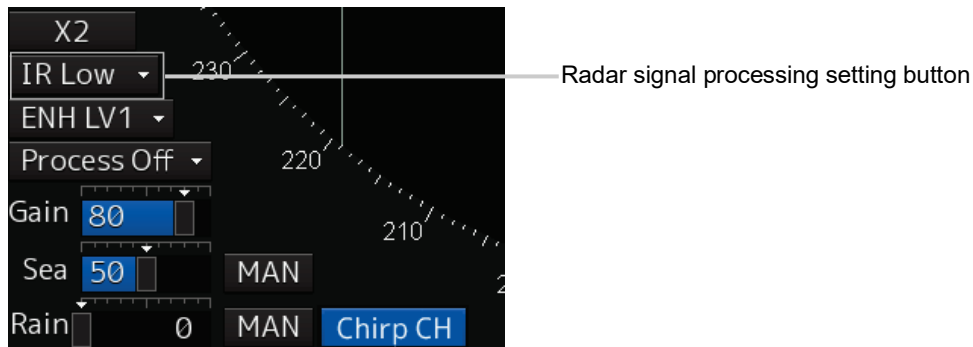

| Setting items | Functions and effects |
|---------------|--|
| IR Off | Sets the IR function to Off. |
| IR Low | Sets the IR level to the low level. |
| IR MID | Sets the IR level to the middle level. |
| IR High | Sets the IR level to the high level. |

[Points on setting]

When a high interference rejection level is selected, the radar's ability of detecting small targets such as buoys and small boats is lower.

In general, [IR Low] should be selected.

5.4.2 Changing the transmitter pulse length

1 Click on the Transmitter Pulse Length switch button in radar signal information.

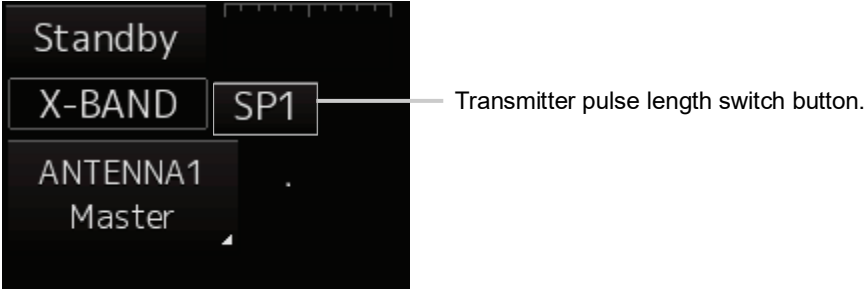

Each time this button is clicked on, the transmitter pulse length changes.

Example: [MP1] → [MP2] → [LP1] → [LP2]
 ↑—————↓

| Transmitter pulse length | Functions and effects | Recommended condition for selection |
|--------------------------|--|---|
| [SP] | <ul style="list-style-type: none"> The transmitter pulse becomes shorter, and the range resolution improves. The effect of suppressing sea clutter and rain/snow clutter improves. | In bays/harbors where targets are densely crowded Rough sea state due to torrential rain or stormy weather |
| [MP] | <ul style="list-style-type: none"> The normal transmitter pulse length is set. Both range resolution and gain are appropriately set. | General navigation |
| [LP] | <ul style="list-style-type: none"> The transmitter pulse becomes longer, and gain improves. Small targets are zoomed and are easy to observe. When the sea state is bad, detection performance decreases. | Detection of small targets in good weather conditions |

Memo
 Usable transmitter pulse length differs according to the type of radar antenna being used and the observation range being used.

5.4.3 Enhancing targets

This function enlarges the display sizes of images to enhance targets.

- 1 Select a target enhancement level from the [Target Enhance] combo box of Radar signal information.

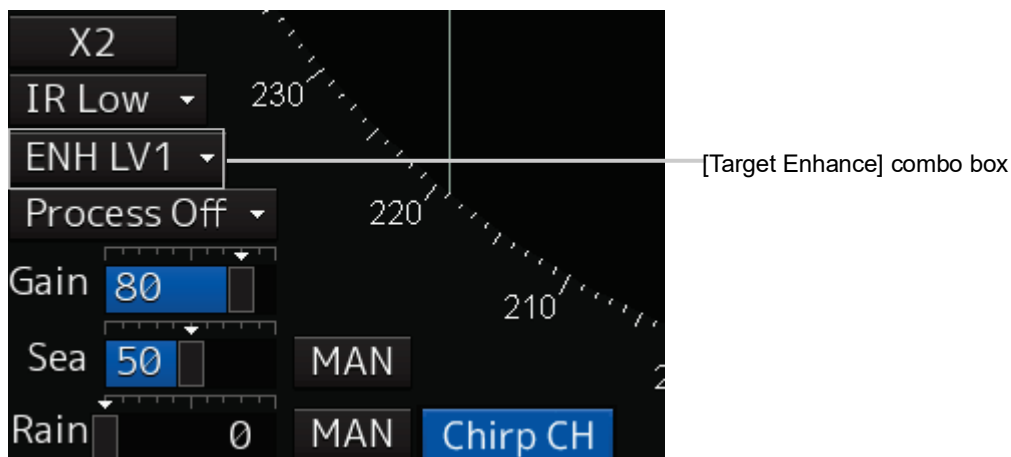

| Setting items | Functions and effects | Recommended use condition |
|---------------|--|---|
| Off | Sets the target enhancement function to OFF. | Set this function to Off when resolution is particularly necessary. |
| ENH Level1 | Enhances the radar echo by 1 level in the vertical and horizontal directions of the screen. | Normal navigation |
| ENH Level2 | Enhances the radar echo by 2 levels in the vertical and horizontal directions of the screen. | Enhance the visibility of the radar image |
| ENH Level3 | Enhances the radar echo by 3 levels in the vertical and horizontal directions of the screen. | Detect small targets such as buoys |

[Setting points]

When [ENH Level3] is selected, sea clutter and rain/snow clutter are apt to be enlarged. To use, suppress images of sea clutter and rain/snow clutter using the [Sea] (sea clutter adjustment) slider and the [Rain] (rain/snow clutter adjustment) slider.

In general, [ENH Level1] or [ENH Level2] should be selected.

5.4.4 Using video processing (Echo Process)

This function reduces undesirable noise and enhances targets.

Memo

- When viewing a radar beacon, SART signal, or fast moving target on the radar display, select [Process Off] (video process off).
- If video processing mode is set to [CORREL], a high speed target is less-visible .

- 1 Select a video processing mode from [Echo Process] (video processing) list of Radar signal information.

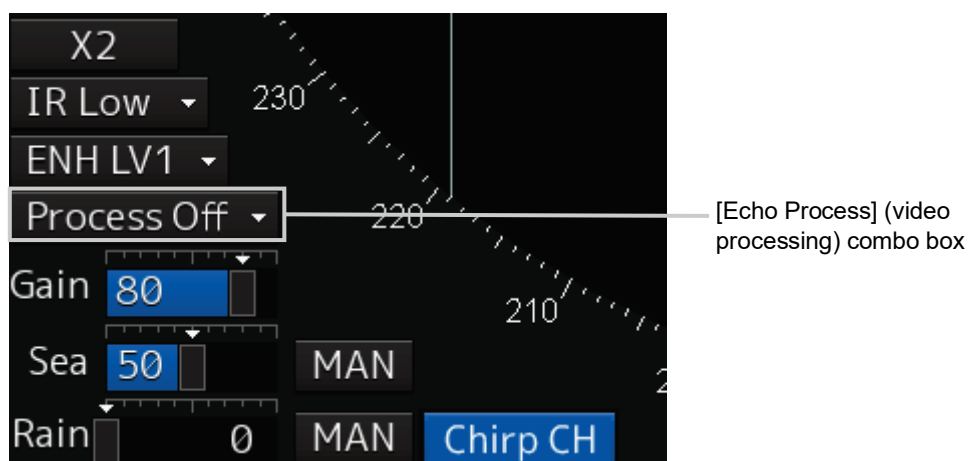

| Setting items | Effects and recommended use conditions |
|---------------|---|
| Process Off | Sets the image processing function to Off. |
| 3 Scan CORREL | Use when the rain/snow clutter images are heavy. |
| 4 Scan CORREL | Use when enhancing the target while suppressing sea clutter images. |
| 5 Scan CORREL | Use when detecting small targets in sea clutter images. |
| Remain | Use when own ship is rolling severely. |
| Peak Hold | Use for detection of small targets of low detection probability. |

5.4.5 Setting the azimuth mode

Set the bearing for the radar video to be displayed on the radar display.

- 1 Click on the azimuth mode combo box of Range and mode information.

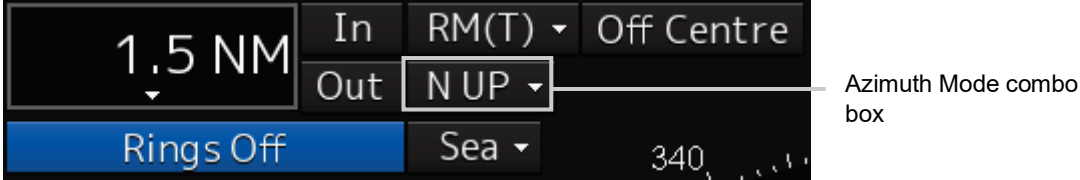

- 2 Select the Azimuth mode.

Memo
 Available combinations vary depending on the settings of the azimuth mode and the motion mode (refer to "5.4.6 Setting a motion mode").

| Azimuth mode \ Motion mode | N UP | H UP | C UP | C UP (Angle Setting) |
|----------------------------|------|------|------|----------------------|
| TM | ○ | × | ○ | ○ |
| RM(T) or RM(R) | ○ | ○ | ○ | ○ |

The following azimuth modes can be set.

| Setting items | Description | Display image |
|------------------------|--|---------------|
| [N UP] | <p>North UP (North Up)</p> <ul style="list-style-type: none"> The video is displayed so that the zenith of the PPI points to the due north. Fixed targets do not flicker and are easily identified on the chart, and the true bearing of a target can easily be read out. | |
| [H UP] | <p>Head UP (Head Up)</p> <ul style="list-style-type: none"> The video is displayed so that the ship's heading line is displayed at the top of the screen. Since targets are displayed in their directions relative to the ship's heading line, the operator can view the video in the same field of view as in operating the ship at sea. Therefore, This mode is suitable for watching over other ships This is not available for TM (True Motion) mode. | |
| [C UP] | <p>Course UP (Course Up)</p> <ul style="list-style-type: none"> At the setting of Course Up, the ship's heading (HDG) is fixed and displayed immediately above the screen. Similar to true bearing display, the positions of stationary targets will not deviate even if yawing occurs in the ship: targets are displayed stably and the bearing of the heading line moves only according to the amount of change in own ship's course. To change the course, select the Course UP display by clicking on the Azimuth mode combo box several times. A course can be set again. | |
| [C UP (Angle Setting)] | <p>Course UP by angle setting (Course Up by angle setting)</p> <ul style="list-style-type: none"> When C UP is selected, the [C UP (Angle Setting)] dialogue box is displayed. The course angle that is set in the dialogue box is displayed by being fixed at the top of the screen. <ul style="list-style-type: none"> Input the angle of the ship's heading in the [Angle] input box of the [C UP (Angle Setting)] dialogue box. The angle can also be input (increase/decrease) by operating the angle input slider. After completing the setting, click on the [X] button. | |

5.4.6 Setting a motion mode

By setting a motion mode, the display method of the own ship's position on the radar screen can be changed.

Switching relative motion (RM) mode to true motion (TM) mode

- 1 Click on the Motion Mode combo box in Range and mode information.

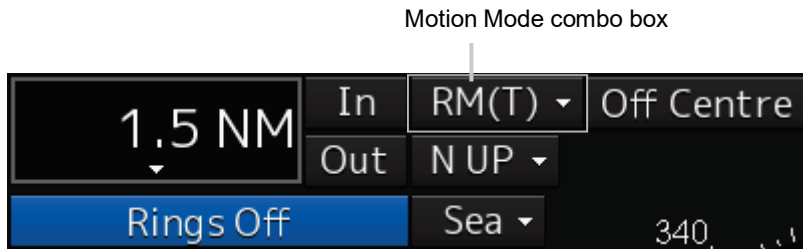

- 2 Select the motion mode.

Memo

Available combinations vary depending on the settings of the motion mode and the azimuth mode (refer to "5.4.5 Setting the azimuth mode").

| Azimuth mode Motion mode | N UP | H UP | C UP | C UP (Angle Setting) |
|-----------------------------|------|------|------|-------------------------|
| TM | ○ | × | ○ | ○ |
| RM(T) or RM(R) | ○ | ○ | ○ | ○ |

| Setting items | Description | Display image |
|--------------------------|---|---------------|
| [TM] | <p>True Motion Mode (True Motion display)</p> <ul style="list-style-type: none"> • In Ground mode, the own ship's display position moves according to the Speed Over the Ground (SOG) and fixed targets such as land are fixed on the radar screen. • In Water mode, the own ship's display position moves according to the Speed Through Water (STW) and fixed targets such as land move according to the difference between the Speed Through Water (STW) and the Speed Over the Ground (SOG). • When the own ship reaches to the true motion status, the own ship's position is set at the position of about 69% of the screen radius in direction opposite to the own ship's course by adding the influence of the tidal current. The ship's position starts to move according to the own ship's speed, course, and influence of the tidal current. When the own ship's position reaches the position of about 69% of the screen radius, the position is reset to the position of about 75% of the screen radius in the direction opposite to the own ship's course (COG) by adding the influence of the tidal current at that time. | |
| [RM(T)] or [RM(R)] | <p>Relative Motion Mode (Relative Motion display)</p> <ul style="list-style-type: none"> • Own ship is fixed at the centre of the radar screen and fixed targets such as land move relatively. | |
| [TM Reset] | <p>TM Reset</p> <ul style="list-style-type: none"> • The own ship's position is reset in [TM] (true motion display) mode. For the details, refer to "5.4.6.1 Resetting own ship to its initial position in [TM] (True Motion display) mode". | |

5.4.6.1 Resetting own ship to its initial position in [TM] (True Motion display) mode

1 Select [TM Reset] from the Motion mode.

Own ship is reset to its initial position as established when the relative motion mode is changed to the true motion mode. The ship starts moving from that position.

5.4.7 Setting the stabilisation mode

- 1 Click on the Stabilisation mode combo box in Range and mode information.

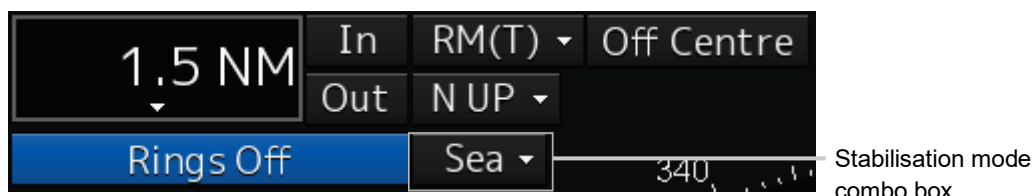

- 2 Select the stabilisation mode.

[GND]: Use the ship speed relative to ground in the stabilisation mode.

[Sea]: Use the ship speed relative to water in the stabilisation mode.

5.4.8 Moving own ship's display position (Off Centre)

The own ship's position can be moved from the display centre to any position within 75% of the display radius. This function is convenient for observing a wide coverage in any direction.

Memo

- This function is not available on the 96 NM range.
- An own ship display position can be moved within the range in which the own ship display position and the antenna position do not exceed 75% of the screen radius.

- 1 Set the Off Centre mode to On by clicking on the [Off Centre] button in range and mode information.

The Off Centre mode is switched to On/Off whenever the button is clicked on.

When the Off Centre mode is On: 

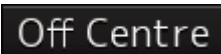
When the Off Centre mode is Off: 

The cursor mode is set to the Off Centre mode.

2 Place the cursor on the position you want to move and click on it.

Own ship's display position will be moved to the clicked position.

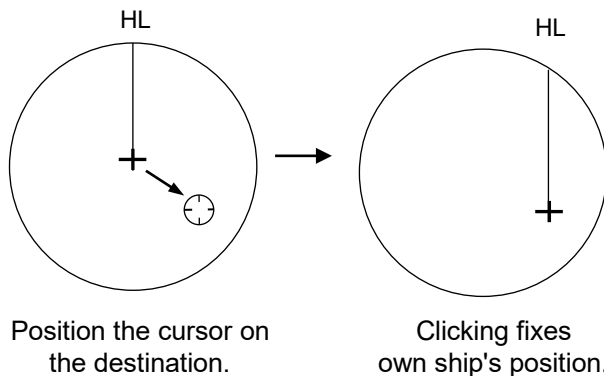

Returning own ship's position to the centre of the display

1 Set the Off Centre mode to Off by clicking on [Off Centre] button in Range and mode information.

The own ship position is returned to the centre of the display (on relative motion) or the position to be reset (on true motion).

5.4.9 Displaying other ship's trails (Trails)

Other ships' movements and speeds can be monitored from the lengths and directions of their trails, serving for collision avoidance.

5.4.9.1 Trails motion mode

There are two types of trails: relative motion trail and true motion trail.

Relative motion trail: The system plots the trails of a target at a position relative to the own ship. The operator can easily judge whether the target is approaching the own ship.

While the own ship is moving, the system also plots the trails of land and other fixed targets.

True motion trail: The system plots the absolute motion trails of a target, irrespective of the own ship's position.

The operator can easily judge the course and speed of the target.

The system does not plot the trails of land and other fixed targets.

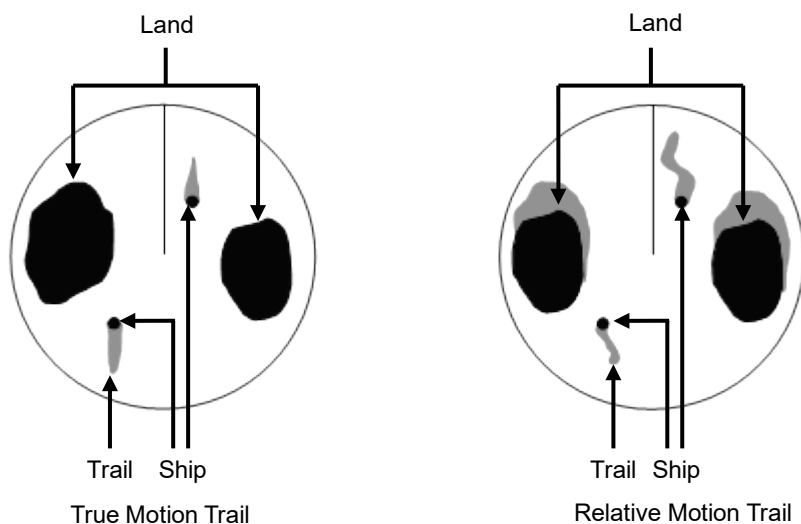

While the true motion trail mode is active, this equipment enables the continuous use of true motion trail even if any of the following operations is performed:

- Motion mode change (TM/RM)
- TM reset
- Azimuth mode change
- Off Centre

Memo

Accurate true bearing signals and speed signals are necessary for using the true motion trail mode.

5.4.9.2 Changing motion mode of trails

The trail display mode can be switched by using the Trail true/relative switching button of other ship information.

Memo

The available trail motion modes vary depending of the motion mode that is set.

True motion display (TM) : Only true motion trail is available.

Relative motion display (RM) : Relative motion trail and true motion trail can be selected.

[RM(T)] is displayed when relative motion trail is used.

[RM(R)] is displayed when true motion trail is used.

1 Click on the Trails True/Relative switch button.

Each time this button is clicked on, the display mode of Trails switches between [T] and [R].

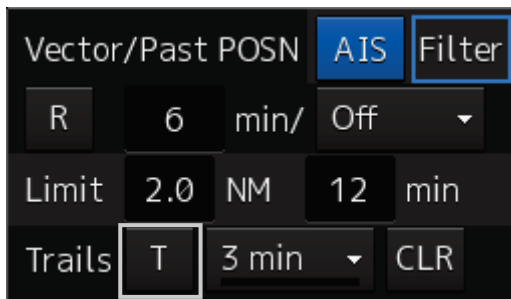

[T]: (True motion trail)

[R]: (Relative motion trail)

For the details of the motion mode of trails, refer to "5.4.9.1 Trails motion mode".

5.4.9.3 Setting the length of the trail

1 Click on the Trail Length switch combo box in [Trails] of other ships' information.

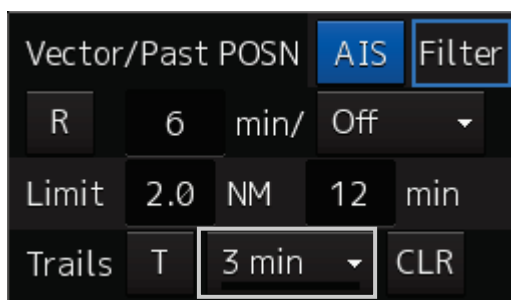

Select a radar trail length.

Short mode: Off, 15 sec, 30 sec, 1 min, 3 min, 6 min, 10 min, 15 min, 30 min, 60 min

Long mode: Off, 30 min, 1 hr, 2 to 24 hrs (at 1 hr interval from 1 to 24 hrs)

Memo

Saved trails cannot be erased even when the trail lengths are changed the Trail Length switch combo box.

Even after the trails display is turned off once, the past trails can be displayed traced back by setting a desired time. The plot of the trail starts when starting the transmission.

The system is plotting trails even while the trails display is off.

If only a short time has elapsed after the commencement of transmission, the display may not reach the specified value. The time not to reach is indicated by the length of the blue bar shown at the lower part of the Trail Length switch combo box.

5.4.9.4 Clearing trails data

- 1 Click on the [CLR] (clear trails) button.



The confirmation dialogue box appears.

- 2 Click on the [OK] button.

All the saved trails data will be cleared. The system starts plotting trails in initial state.

5.4.10 Doubling the size of radar image

This function doubles the size of radar video near a specified position.

Memo

If the range is 0.125 NM and the motion mode is in the TM mode, this function is not available.

- 1 Click on the [X2] (double zoom) button in Radar signal information.

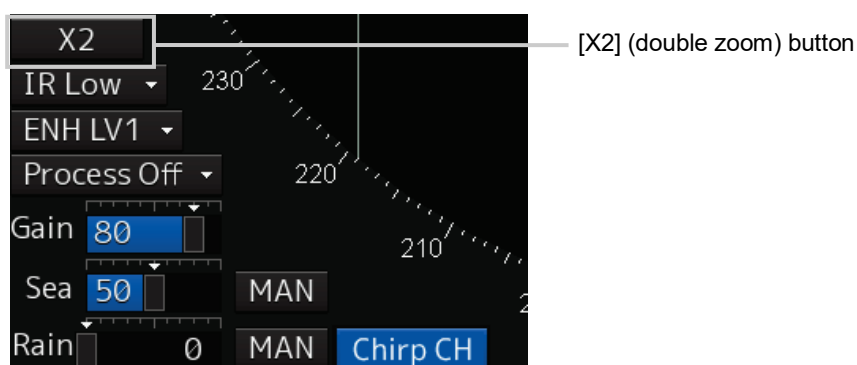

Each time this button is clicked on, the double zoom function is switched On and Off.

On display: 

Off display: 

When double zoom is set, the cursor mode changes to the off-set cursor.

- 2 Place the offset cursor on a location you want to zoom and click on it.

Using the cursor position as the reference, the screen display is enlarged by a magnification of 2 so that the midpoint between the cursor and own ship's position comes at the centre of the radar display.

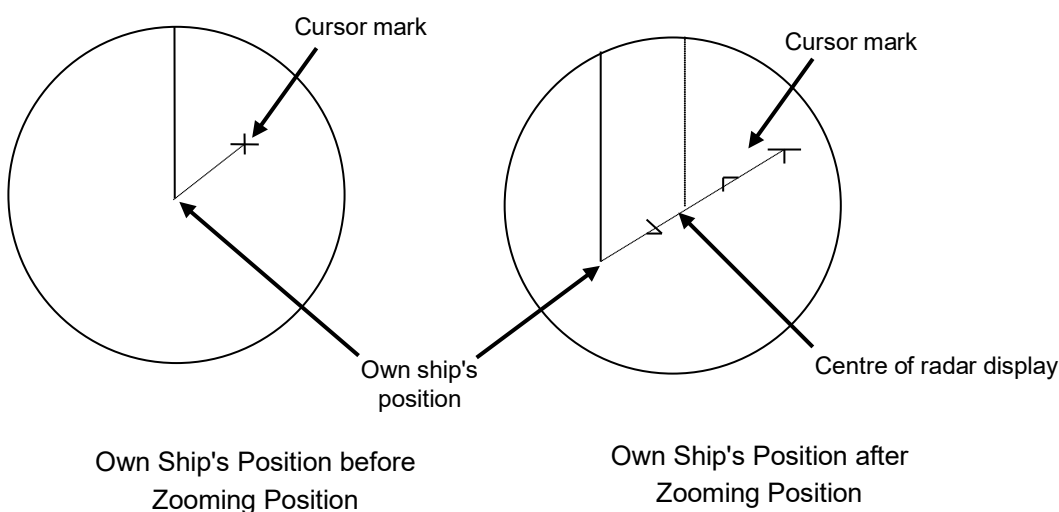

Canceling zoom display

- 1 Set the double zoom function to Off by clicking on the [X2] button.

Off display: 

5.4.11 Hiding the heading line (HL OFF)

- 1 The ship's heading line is hidden while the [HL Off] (ship's heading line Off) button is pressed down.

When the button is released, the ship's heading line is redisplayed.



5.4.12 Hiding graphics information on radar display

On the radar screen of this equipment, various types of graphics information such as TT/AIS symbol, user map, and chart information are displayed. When the visibility of the radar screen deteriorates due to excessive amount of graphic information displayed, the visibility of the screen can be improved by temporarily clearing the unnecessary graphic information by using this function.

- 1 While the [Data Off] button on the toolbar is pressed down, graphic information other than TT and AIS of danger targets, radar images, radar trails, and cross-hairs cursor are hidden.**

When the button is released, graphics information is redisplayed.



5.4.13 Setting true bearing

When the GYRO I/F is used to enter a gyro signal, there is a rare case in which a true bearing value indicated by the master gyro does not match the true bearing value indicated by this equipment.

In that case, adjust the true bearing value of this system so that it matches the value indicated by the master gyro.

[Operation procedure]

Open the gyro setting screen by performing the following operations.

[Menu] button → Settings → General

- 1 Select the [Gyro Setting] input box.**
- 2 Input a master gyro value on the software keyboard.**

5.4.14 Setting own ship speed

5.4.14.1 Switching own ship speed device

- 1 Select the ship speed device from the [STW] combo box of own ship's information.

| | | |
|-----------|--------------|----------|
| LMT | 2017-01-30 | 00:21:37 |
| HDG | Gyro | 310.0 ° |
| STW | Log | 3.6 kn |
| COG | GPS | 081.8 ° |
| SOG | | 1.0 kn |
| POSN DGPS | 31°59.915' S | |
| GPS | 60°00.775' E | |
| WGS84 | | |

Memo

- When using 1-axis log, heading speed component can be detected, but transverse speed component cannot be detected. Then leeway effect (component drifted by wind) cannot be detected.
- When using 2-axes ground log, its accuracy in shallow waters may be deteriorated, and its speed in deep sea areas may be unable to be detected.
- When using a GPS, COG accuracy is less than $\pm 3^\circ$ at speed: from 1kn to 17kn, and is less than $\pm 1^\circ$ at speed: more than 17kn.

5.4.14.2 Entering the ship's heading/own ship's speed manually

If any of the devices connected to this equipment (example: Log) malfunctions, use the following procedure to input the ship's heading/own ship's speed so as to make the target tracking device and the true motion display available.

- 1 Select [Menu] from the corresponding combo box.

| | | |
|-----------|--------------|----------|
| LMT | 2017-01-30 | 00:21:37 |
| HDG | Gyro | 310.0 ° |
| STW | Log | 3.6 kn |
| COG | GPS | 081.8 ° |
| SOG | | 1.0 kn |
| POSN DGPS | 31°59.915' S | |
| GPS | 60°00.775' E | |
| WGS84 | | |

The [Sensor Selection/Status] dialogue box is displayed.

- 2 To input ship's heading manually, select [MAN] from the [HDG] combo box. To input own ship's speed manually, select [MAN] from the [STW] combo box.
- 3 Click on the input box.
- 4 Enter a numeric value by using the software keyboard.



Section 6 Target Tracking and AIS

This section explains Target Tracking (hereinafter, referred to as target tracking or TT) and Automatic Identification System (hereinafter referred to as AIS).

CAUTION



Simulation is a function for determining if the target tracking function is working correctly or not. Accordingly, this function should be used only to check for the target tracking function operation.

In particular, if this mode is used during navigation, a pseudo target will appear on the radar screen and cannot be easily identified from the real target. This may cause such an accident as collision. Do not use this mode during the navigation.

Target Tracking

This function calculates the course and speed of a target by automatically tracking the target's move.

This function enables the automatic acquisition of targets by using the automatic acquisition zone function.

This function also enables the simulation of the ship manoeuvring method to avoid collisions by using the trial manoeuvre function.

Memo

If the mode is ground stabilisation, SOG/COG used for own ship's information. If the mode is sea stabilisation, STW (speed through the water)/HDG (heading) is used for own ship's information.

Target tracking range is 32 NM. (Available all range scale)

For the details, refer to "6.5 Setting and operating target tracking".

AIS

This function shows the target's information on the radar display, using other ship's information sent out from the AIS unit.

For the details, refer to "6.6 Setting and operating AIS".

6.1 Restrictions

The acquisition and Target Tracking functions have the following restrictions.

Depending on distance and echo size, resolution between adjacent targets during automatic target tracking usually ranges somewhere between 0.03 to 0.05 NM. If multiple targets approach each other, there is a possibility of swapping them or losing one of them. Such swapping or loss of targets may also occur if the target being tracked is affected by rain/snow clutter or sea clutter or moves very close to land.

The intensity of echoes and the target tracking function are interrelated with each other and if echoes are not detected for sixteen scans or more consecutively, lost target is assumed.

If such a lost target exists, therefore, radar gain must be increased to support detection of the target. If, however, radar gain is increased too significantly, sea clutter or other noise may be erroneously detected and tracked as a target, and resultingly, a false alarm may be issued.

To execute accurate tracking, it becomes necessary first to appropriately adjust the gain, sea clutter suppression, rain/snow clutter suppression and tune of the radar so that the target to be acquired and tracked is clearly displayed on the radar display.

Inappropriate settings of these adjustments reduce the reliability/accuracy of automatic target tracking.

6.2 Collision Avoidance Issue (Explanation)

6.2.1 Collision avoidance in navigation

Marine collision avoidance in navigation is one of the problems that have been recognised from of old. This section contains a brief statement about the position of collision avoidance in navigation.

The navigation pattern of all mobile craft constitutes a system with some closed loops regardless of the media through which the mobile craft travels, whether air, water, the boundary between air and water, or space. This pattern consists of two closed loops in principle, one of which is a collision avoidance with another mobile craft and the other is a loop of finding a right and safe way to reach a predeterminate destination.

The following figure shows the conceptual diagram of navigation pattern by Mr. E.W. Anderson. The closed loop of collision avoidance is shown on the left side and the closed loop of finding a safe route on the right side.

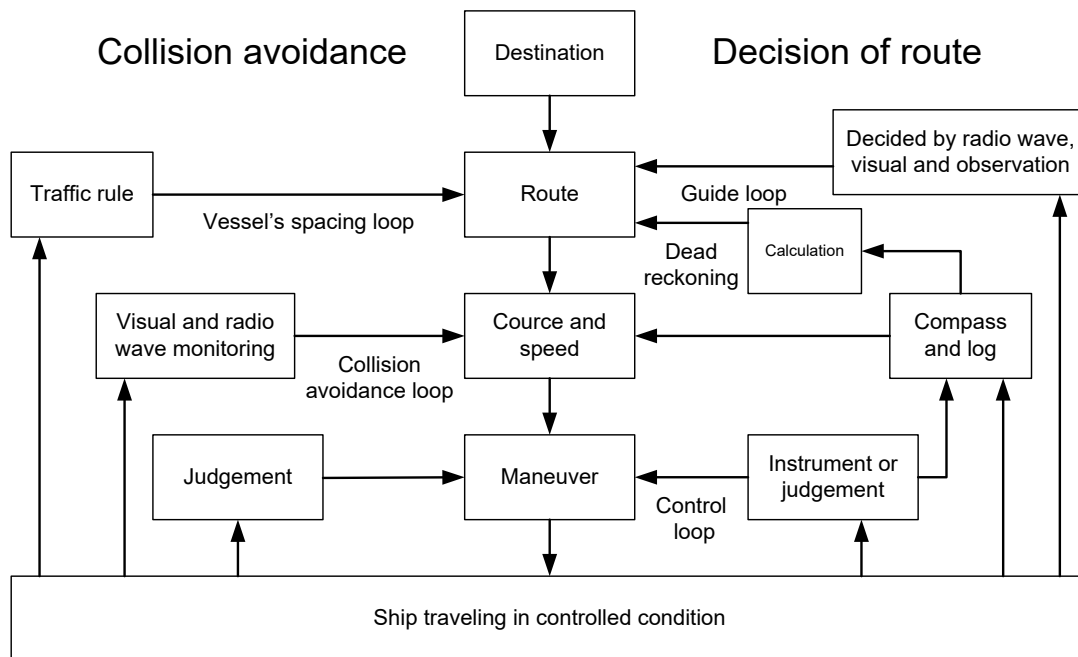

Navigation Pattern

6.2.2 Marine accidents and collisions

Among marine accidents, collision accidents have been highlighted as the tonnages and speeds of ships become higher along with the increase in traffic at sea.

If a tanker carrying dangerous articles such as crude oil collides with any other vessel, then not only the vessels involved with the accident but other vessels in the vicinity, port facilities and inhabitants in the coastal area as well as marine resources may also suffer immeasurable influence.

Collision accidents have a high percentage of the marine accidents that have occurred in recent years. To cope with these problems, any effective measures are needed and some equipment to achieve collision avoidance requirements has been developed at rapid strides.

6.2.3 Basic concept of collision avoidance

There are two aspects in collision avoidance: collision prediction and avoidance. Putting it in extreme terms, collision prediction is to predict that two or more vessels will happen to occupy the same point at the same time, while collision avoidance is to manoeuvre vessels not to occupy the same point at the same time.

In practical operation of vessels, a spot of collision has to be deemed to be a single point but a closed zone. This closed zone is conceptually defined as a CPA (Closest Point of Approach). Further, the time taken to arrive at CPA is required for collision prediction, and the danger of collision is judged considering the TCPA (Time to CPA). The following figure illustrates a diagram caked "Collision Triangle".

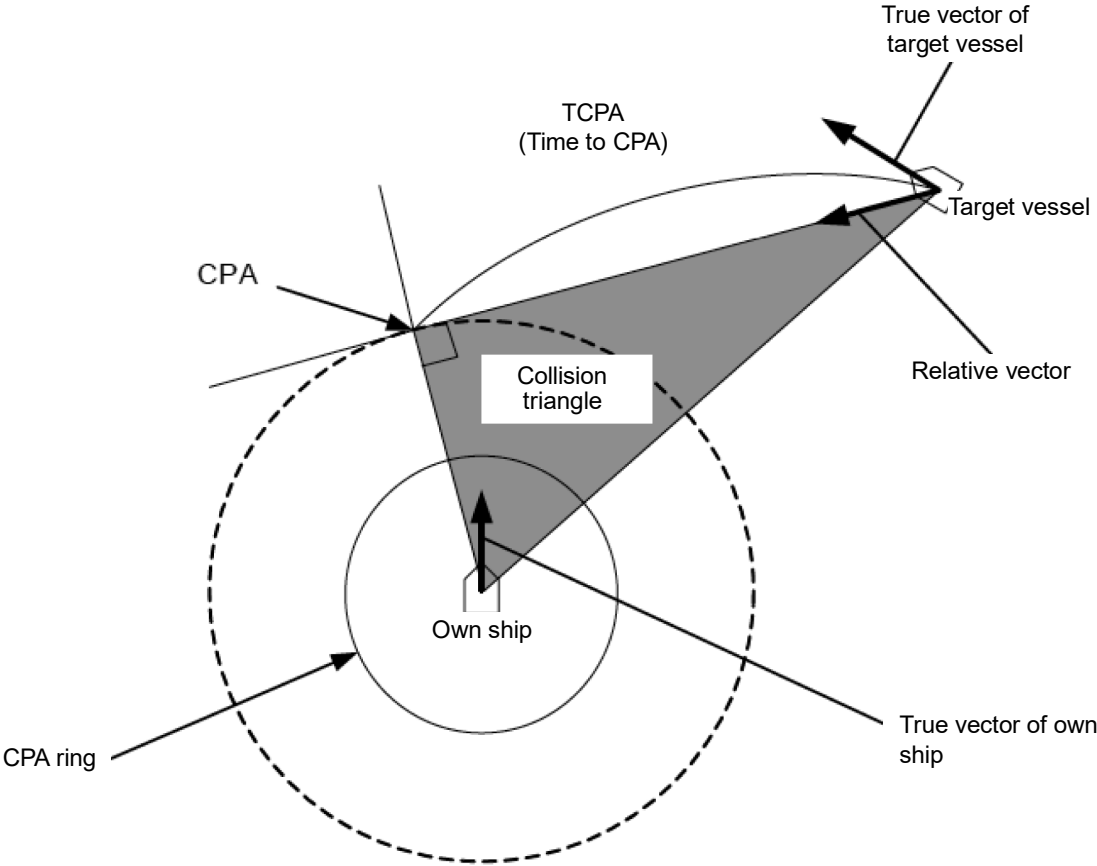

6.2.4 Relative vector and true vector

From two points of view, collision prediction and avoidance, it is necessary to obtain the relative vector of other ship for prediction and the true vector of other ship for collision avoidance in order to realize other ship's aspect.

The relationship between the relative vector and true vector is shown in the following figure.

Furthermore, the meanings of both vectors are explained.

Both rough CPA and TCPA can be obtained easily from the relative speed vector of other ship. This method has an advantage that the risks of collision with all other ships within the radar range can be seen at a glance. On the other hand, the course and speed of other ship can easily be obtained from its true speed vector, enabling other ship's aspect to be seen at a glance. Thus, the aspects of other ships (transverse, outsail, parallel run, reverse run, etc.) as described in the act of prevention of collision at sea can be readily understood. If there is a risk of collision with other ship, the operator can determine which rule to be applied and how to operate own ship.

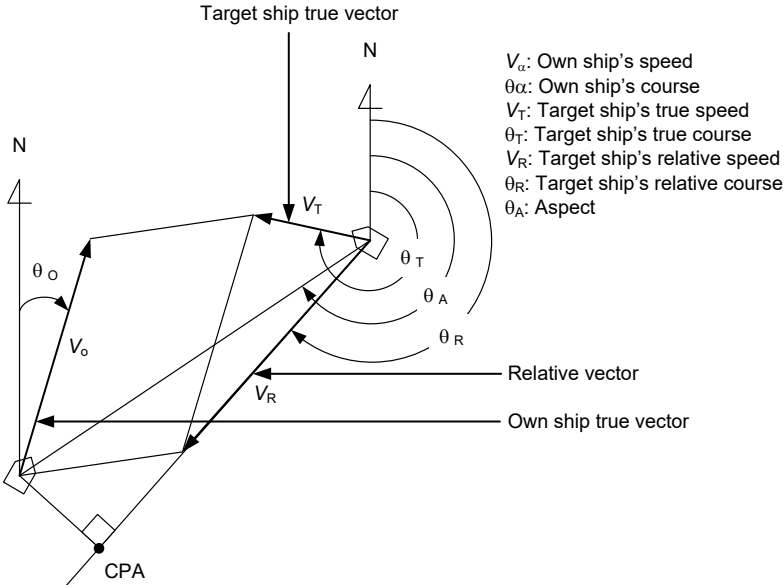

6.2.5 Radar and collision avoidance

Radar is still playing an important role for collision prevention and positioning.

A plotter is used to further enhance the radar functionality. The plotter is capable of plotting other positions of other ships in 3 to 6 minute intervals to monitor their movement. The plots of other ships represent their tracks relative to own ship, and it is shown whether there is a risk of collision, namely CPA and TCPA can be obtained. This method using a plotter is fairly effective, but the number of target ship, which is manually plotted, is limited and it takes several minutes to measure those.







6.3 Displaying Symbols

This section describes the symbols that are used for target tracking and AIS.



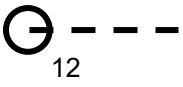

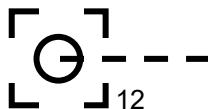

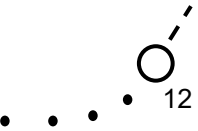
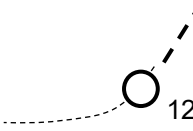



6.3.1 Displaying/hiding target tracking symbols/AIS target symbols













The displays of the target tracking symbols and AIS target symbols are set to enable at the time of shipment from factory. The setting can be changed to display or hide by selecting [View] - [Target]. For the details, refer to "11.1.6 Setting up the display of TT/AIS target".







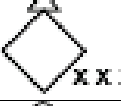

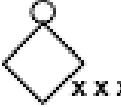
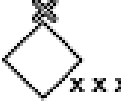



6.3.2 Types and definitions of target tracking symbols











| Symbol | Definition | Remarks |
|---|---|---|
|  | Initial acquisition target | This symbol is displayed until the vector is displayed after target acquisition. |
|  | Target acquired in automatic acquisition zone | The alarm sounds. The alarm message (New Target) turns orange and blinks. The symbol turns red and blinks. |
|  | Tracked target | This means a tracked target. |
|  | Dangerous target | The alarm sounds. The alarm message (CPA/TCPA) turns red and blinks. The symbol is enlarged and displayed in red. |
|  | Numeric displayed target | When the numeric data is displayed, the target symbol is enclosed in a square. |
|  | Lost target | The alarm sounds. The alarm message (Lost) turns orange and blinks. The symbol turns red. |
|  | Past position | The past positions of an AIS target are displayed as well as the target tracking symbol. |
|  | Target track | The track of another ship as an AIS target is displayed as well as the target tracking symbol. |









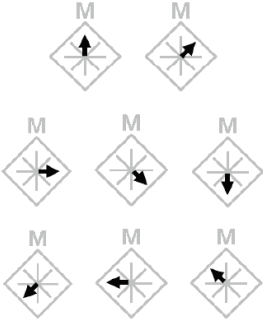

6.3.3 Types and definitions of AIS target symbols





| Symbol | Definition | Remarks |
|---|--------------------------|--|
|  | Sleeping target | This symbol is displayed when received data is valid. The direction of the triangle's vertex indicates the target's heading or course. |
|  | Target in pause state | When CTW/STW of the target cannot be received, the symbol is displayed in a broken line. |
|  | Activated target | The heading direction is displayed with a solid line, and the course vector is displayed with a dotted line. The line perpendicular to the heading direction indicates the direction to which the course is to be changed. This line may not be displayed. |
|  | Activated target | When CTW/STW of the target cannot be received, the symbol is displayed in a broken line. |
|  | Outline display | The outlines of ships are displayed scaled down. |
|  | Numeric displayed target | When the numeric data is displayed, the target symbol is enclosed in a square. |
|  | Dangerous target | The alarm sounds. The alarm message (CPA/TCPA) turns red and blinks. The symbol is enlarged and displayed in red. |
|  | Danger target | When CTW/STW of the target cannot be received, the symbol is displayed in a broken line. |
|  | Lost target | The warning sounds. The warning message (Lost) turns orange and blinks. The symbol is displayed by overlaying red x marks. |
|  | Sleeping AIS-SART target | Displayed by the same colour as AIS symbol. |

| Symbol | Definition | Remarks |
|---|---|--|
|  AIS12 | Activated AIS-SART target | Displayed target No. nearby the symbol. |
|  AIS12 | Numerical display AIS-SART target | When the numeric data is displayed, the target symbol is enclosed in a square. |
|  AIS12 | Lost AIS-SART target | Displayed if AIS-SART data is not received for 6 minutes. |
|  | Physical AIS AtoN target (Racon) | The target No./AtoN name (xxx) is displayed next to the symbol. |
|  | Physical AIS AtoN target (Emergency wreck mark) | The target No./AtoN name (xxx) is displayed next to the symbol. |
|  | Physical AIS AtoN target (North cardinal mark) | The target No./AtoN name (xxx) is displayed next to the symbol. |
|  | Physical AIS AtoN target (East cardinal mark) | The target No./AtoN name (xxx) is displayed next to the symbol. |
|  | Physical AIS AtoN target (South cardinal mark) | The target No./AtoN name (xxx) is displayed next to the symbol. |
|  | Physical AIS AtoN target (West cardinal mark) | The target No./AtoN name (xxx) is displayed next to the symbol. |
|  | Physical AIS AtoN target (Port hand mark) | The target No./AtoN name (xxx) is displayed next to the symbol. |
|  | Physical AIS AtoN target (Starboard hand mark) | The target No./AtoN name (xxx) is displayed next to the symbol. |
|  | Physical AIS AtoN target (Isolated danger) | The target No./AtoN name (xxx) is displayed next to the symbol. |
|  | Physical AIS AtoN target (Safe water) | The target No./AtoN name (xxx) is displayed next to the symbol. |
|  | Physical AIS AtoN target (Special mark) | The target No./AtoN name (xxx) is displayed next to the symbol. |

| Symbol | Definition | Remarks |
|---|---|---|
|  | Physical AIS AtoN target (Off position) | The symbol and target No./AtoN name (xxx) nearby the symbol are indicated in yellow. |
|  | Physical AIS AtoN target (On position) | The target No./AtoN name (xxx) is displayed next to the symbol. |
|  | Physical AIS AtoN target (Numerical display) | When the numeric data is displayed, the target symbol is enclosed in a square. |
|  | Physical AIS AtoN target (Lost display) | The alarm sounds. The alarm message (Lost) turns orange and blinks. The symbol is displayed by overlaying red x marks. |
|  | Physical AIS AtoN target (Flood light abnormality) | "Unlit" is displayed in yellow at the top of the symbol. The target No./AtoN name (xxx) is displayed nearby the symbol. |
|  | Physical AIS AtoN target (radar beacon abnormality) | "Racon err" is displayed in yellow at the top of the symbol. The target No./AtoN name (xxx) is displayed nearby the symbol. |
|  | Virtual AIS AtoN target (Emergency wreck mark) | The target No./AtoN name (xxx) is displayed next to the symbol. |
|  | Virtual AIS AtoN target (North cardinal mark) | The target No./AtoN name (xxx) is displayed next to the symbol. |
|  | Virtual AIS AtoN target (East cardinal mark) | The target No./AtoN name (xxx) is displayed next to the symbol. |
|  | Virtual AIS AtoN target (South cardinal mark) | The target No./AtoN name (xxx) is displayed next to the symbol. |
|  | Virtual AIS AtoN target (West cardinal mark) | The target No./AtoN name (xxx) is displayed next to the symbol. |
|  | Virtual AIS AtoN target (Port hand mark) | The target No./AtoN name (xxx) is displayed next to the symbol. |
|  | Virtual AIS AtoN target (Starboard hand mark) | The target No./AtoN name (xxx) is displayed next to the symbol. |

| Symbol | Definition | Remarks |
|---|---|---|
|  | Virtual AIS AtoN target (Isolated danger) | The target No./AtoN name (xxx) is displayed next to the symbol. |
|  | Virtual AIS AtoN target (Safe water) | The target No./AtoN name (xxx) is displayed next to the symbol. |
|  | Virtual AIS AtoN target (Special mark) | The target No./AtoN name (xxx) is displayed next to the symbol. |
|  | Virtual AIS AtoN target (Numerical display) | When the numeric data is displayed, the target symbol is enclosed in a square. |
|  | Virtual AIS AtoN target (Lost display) | The alarm sounds. The alarm message (Lost) turns orange and blinks. The symbol is displayed by overlaying red x marks. |
|  | Virtual AIS AtoN target (Intended location of missing AtoN) | "Missing" is displayed in yellow at the top of the symbol. The target No./AtoN name (xxx) is displayed nearby the symbol. |
|  | Physical mobile AIS AtoN target | The target No./AtoN name (xxx) is displayed next to the symbol. |
|  | Virtual mobile AIS AtoN target | The target No./AtoN name (xxx) is displayed next to the symbol. |
|  | Virtual AtoN Error | It is an icon when RACON err/off is combined. |
|  | Mobile AIS AtoN target (AtoNStatus = 0xae) | Self-propelled, but direction not reported or unavailable (AtoN Status bits 1010111x): |
|  | Mobile AIS AtoN target (AtoNStatus = 0xaa) | Tethered (AtoN Status bits 1010101x): |

| | | |
|---|---|--|
|  | <p>Mobile AIS AtoN target (COG information is provided)</p> | <p>If COG information is provided, it shall be presented with an arrow pointed in coarse direction of COG within $\pm 22,5^\circ$ sectors as defined by AtoN Status bits.</p> |
|  | <p>AIS SAR aircraft</p> | <p>Displayed by the same colour as AIS symbol.</p> |
|  | <p>Numerical display AIS SAR aircraft</p> | <p>When the numeric data is displayed, the target symbol is enclosed in a square.</p> |
|  | <p>Lost AIS SAR aircraft</p> | <p>The alarm sounds. The alarm message (Lost) turns orange and blinks. The symbol is displayed by overlaying red x marks.</p> |
|  | <p>AIS SAR aircraft (helicopter)</p> | <p>Displayed by the same color as AIS symbol.</p> |
|  | <p>Numerical display AIS SAR aircraft (helicopter)</p> | <p>When the numeric data is displayed, the target symbol is enclosed in a square.</p> |
|  | <p>Lost AIS SAR aircraft (helicopter)</p> | <p>The alarm sounds. The alarm message (Lost) turns orange and blinks. The symbol is displayed by overlaying red x marks.</p> |
|  | <p>AIS SAR ship</p> | <p>Displayed by the same colour as AIS symbol.</p> |
|  | <p>Numerical display AIS SAR ship</p> | <p>When the numeric data is displayed, the target symbol is enclosed in a square.</p> |
|  | <p>Lost numerical display AIS SAR ship</p> | <p>The alarm sounds. The alarm message (Lost) turns orange and blinks. The symbol is displayed by overlaying red x marks.</p> |

| Symbol | Definition | Remarks |
|---|---|---|
|  | AIS coastal base station | Displayed by the same colour as AIS symbol. |
|  | Numerical display AIS coastal base station | When the numeric data is displayed, the target symbol is enclosed in a square. |
|  | Lost AIS coastal base station | The alarm sounds. The alarm message (Lost) turns orange and blinks. The symbol is displayed by overlaying red x marks. |
|  | Call or unread message symbol (Example: Call or unread message symbol with AIS Target) | Received call or unread message shall be presented by having two increasing centered 1/8 arcs drawn using a thin solid line at upper right-hand side of the AIS target symbol, AIS AtoN physical symbol, Base station symbol etc. Displayed by the same color as AIS symbol. |

Memo

The AIS-SART target symbol is displayed in red when the target is activated.

6.3.4 About AIS AtoN (Aids to Navigation)

AIS AtoN is a system that displaying aid to navigation like a lighthouse, light buoy or unreal aid to navigation on the display unit on ships using AIS receiver.

There are following two kinds of AIS AtoN.

| AIS AtoN type | Function | Operation example |
|--------------------------|--|--|
| Physical AIS AtoN | Installs the AIS on real aid to navigation, and displays its location on the display unit on ships. | In low visibility, receiving the Physical AIS AtoN symbols facilitates identification of the light location and light buoy. |
| Virtual AIS AtoN | Displays virtual aid to navigation on the display unit on ships according to the signals transmitted from the AIS station on the land. | In the sea area where installation of the light buoy is difficult, the Virtual AIS AtoN symbols are displayed as virtual light buoys that are used as targets for getting to the destination. This system can also be used as the aid substituted for the aid to navigation damaged by natural disasters. |
| Physical mobile AIS AtoN | Installs the AIS on real aid to navigation, and displays its location on the display unit on ships. | In low visibility, receiving the Physical AIS AtoN symbols facilitates identification of the mark a moving or drifting hazard to navigation. |
| Virtual mobile AIS AtoN | Displays virtual aid to navigation on the display unit on ships according to the signals transmitted from the AIS station on the land. | In the sea area where installation of the physical mobile AIS AtoN is difficult, the Virtual mobile AIS AtoN symbols are displayed as virtual mark a moving or drifting hazard to navigation that are used as targets for getting to the destination. |

6.3.5 About AIS-SART Information

The AIS-SART function enables information about the location of wrecked ship to be displayed on the screen.

For the details, refer to "7.6 Display of AIS-SART".

6.3.6 About display priority of AIS targets

Up to 180*1 targets can be displayed in total of activated and sleeping AIS targets.

When there is an AIS target of 180*1 or more, the display is made according to the following priority order.

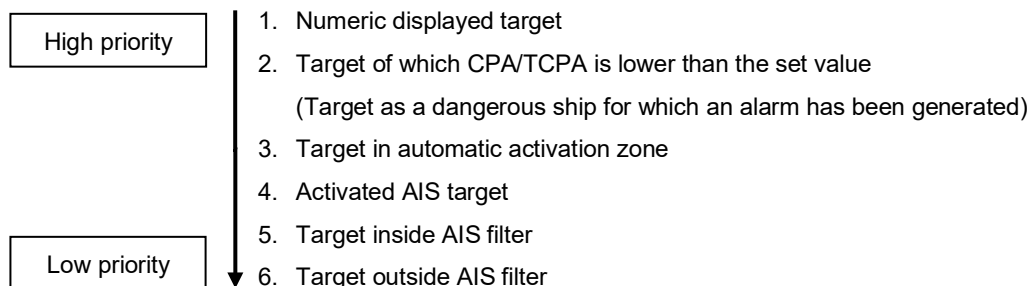

*1: The maximum number of AIS targets displayed can be changed to the option of 1000 targets.

If the number of targets at the same priority level exceeds the allowable maximum, they are displayed in the following priority order:

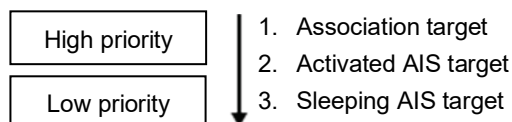

Memo

Maximum display number is sum of Class A AIS and Class B AIS.

Class A: The AIS that must be installed in the large ships specified in the SOLAS Convention.

Class B: The AIS for which medium and small sized vessels and fishing vessels are targeted.

<AIS Capacity>

AIS target=460 or 960

95%,Full:Caution (See 5.5.3 for alerts.)

AIS data report=20

Full:Information (See 5.13.2 for alerts.)

AIS locating device=20

Full:Information (See 5.14.2 for alerts.)

The AIS target number depends on the MAX AIS Number of installed licenses. Check the installed license in Menu - Maintenance - System information - Functionality.

- AIS target = 460 (MAX AIS Number = 500)

- AIS target = 960 (MAX AIS Number = 1000)

6.3.7 Switching between ground vector and water vector

The vector of an AIS target is to be displayed with a vector over ground or over water by switching the stabilisation mode. The type of the currently displayed vector can be confirmed by viewing the setting of the stable mode.

When [GND] is selected for the stabilisation mode: Ground vector

When [Sea] is displayed for the stabilisation mode: Water vector

When the vector of an AIS target is displayed with a vector over water, the system has converted the AIS target's vector over ground to the vector over water according to the data received from the AIS and the own ship's information.

6.3.8 Association target symbols

When the TT target and AIS target are determined to be the same targets, the association symbols are displayed as follows.

Symbol display for high-priority TT targets



12 — Association targets

Symbol display for high-priority AIS targets



AIS12 — Association targets

When the TT target and AIS target are determined to be the same targets, the TT target or AIS target that are displayed on a higher priority basis can be set.

1 Right-click on the tracked target with association displayed.

The context menu appears.

2 Click on [Property] in the context menu.

The [TT Target INFO] or [AIS Target INFO] dialogue appears.

3 Select [AIS] or [TT] from the [Priority] combo box.

[AIS]: The AIS target is displayed on a higher priority basis.

[TT]: The TT target is displayed on a higher priority basis.

6.4 Preparation

6.4.1 Setting the cursor mode to AUTO mode

If the cursor mode is set to the AUTO mode, various TT/AIS functions can be executed quickly.

- 1 Click on the [AUTO] (cursor mode selection) button on the toolbar.

The cursor mode changes to the AUTO mode.

The [AUTO] mode performs operation in accordance with the object at the cursor position when clicked.

For the details, refer to "3.15 Cursor AUTO Mode".

6.4.2 Setting vector

A vector to represent a target's predicted position can be presented in the True vector or Relative vector mode. In each mode, a Vector Length can be freely changed for a time interval of 1 to 120 minutes.

6.4.2.1 Vector modes

Different vector modes can be used as described below according to the purpose.

To perceive the true state of the target: True Vector

To perceive the closest approach point of the target: Relative Vector

True vector mode

In the true vector mode, the directions of vectors indicate the true courses of targets and the Vector Lengths indicate the values which are proportional to their speeds.

In the true vector mode, the movements of other ships around own ship can be accurately and easily monitored.

Vectors of own ship are displayed as shown below.

Memo

In true vector mode, CPA ring cannot be displayed.

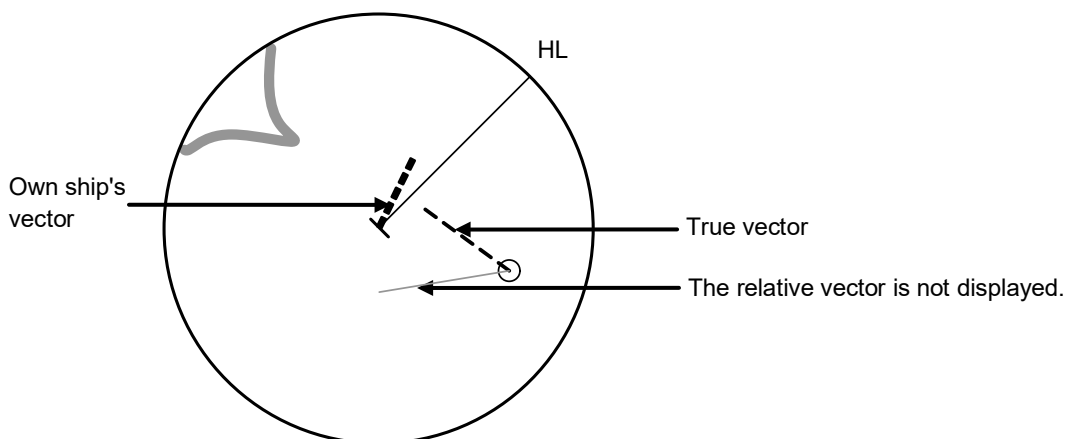

Example of True Vector Mode

Relative Vector Mode

The relative vector does not represent the true motion of the target, but its relative relation with own ship. A target with its relative vector directed to own ship (passing through the CPA limit ring) will be a dangerous target.

In the Relative Vector mode, it can be seen at a glance where the CPA limit of the dangerous target is.

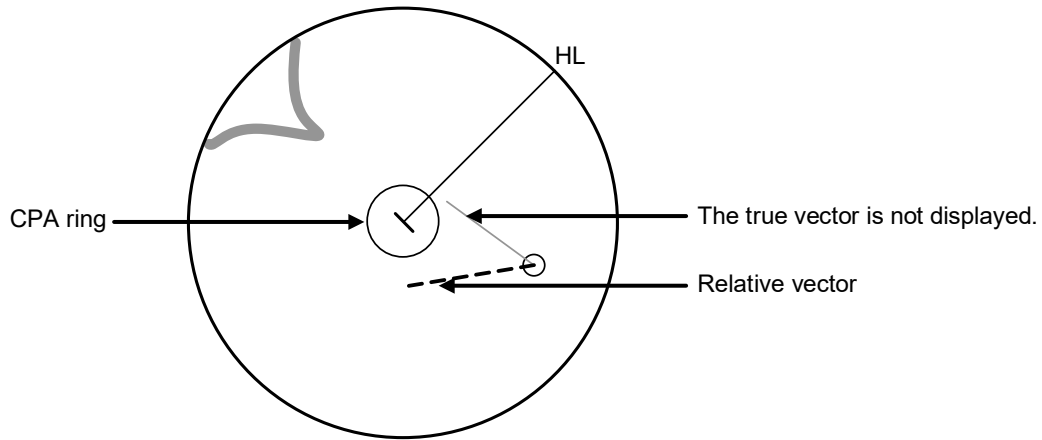

Example of Relative Vector Mode

6.4.2.2 Setting vector mode

- 1 Click on the Vector/Past POSN true/relative selector button in the other ship information window.

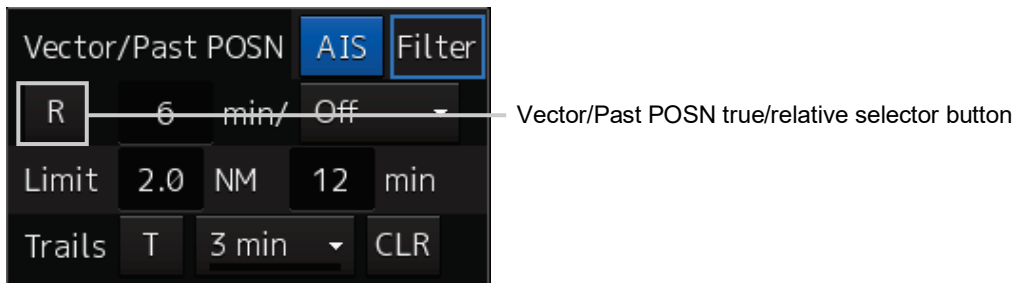

Each click switches track display mode between [T] and [R].

6.4.2.3 Vector length (Vector time)

The Vector Length of a target is proportional to its speed, and the vector time can be switched in a range of 1 to 120 minutes.

The following figure shows an example in which the Vector Length is set to 6 min, and the tip of the vector represents the target's position expected to reach 6 minutes later.

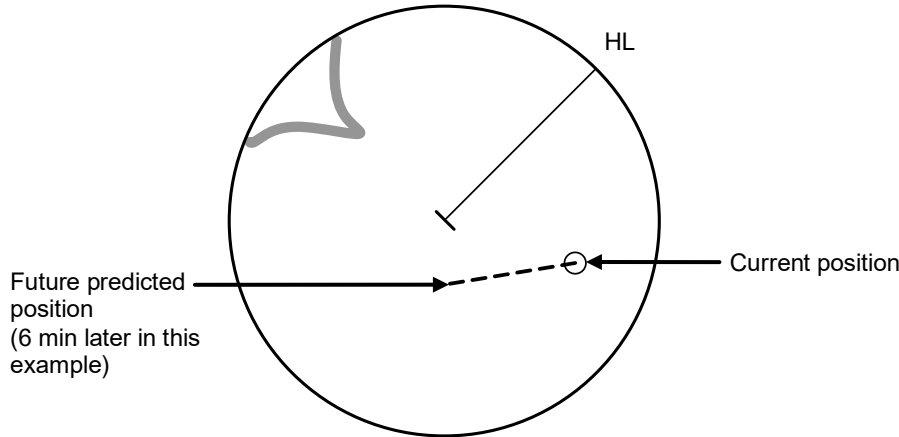

Example of Vector Length

6.4.2.4 Setting the vector length

The Vector Length is set in min in the range from 1 min to 120 min.

- 1 Click on the Vector Length input box in the other ship information window.



- 2 Enter the Vector Length.

6.4.3 Setting collision decision criteria

Collision decision criteria are set based on CPA and TCPA.

For an outline of CPA and TCPA, refer to "6.2.3 Basic concept of collision avoidance."

Memo

Set the optimum values of collision decision conditions, with consideration for vessel type, water area, weather and oceanographic conditions.

For the relations between those conditions and alarms, refer to "6.7 Alert Display".

6.4.3.1 Setting CPA limit

- 1 Click on the CPA limit value input box in the other ship information window.

Set the CPA limit in the unit of 0.1 NM within the range from 0.1 NM to 9.9 NM.



- 2 Enter the CPA limit.

6.4.3.2 Setting TCPA limit

- 1 Click on the TCPA limit value input box in the other ship information window.

Set the TCPA limit in the unit of 1 min within the range from 1 min to 99 min.

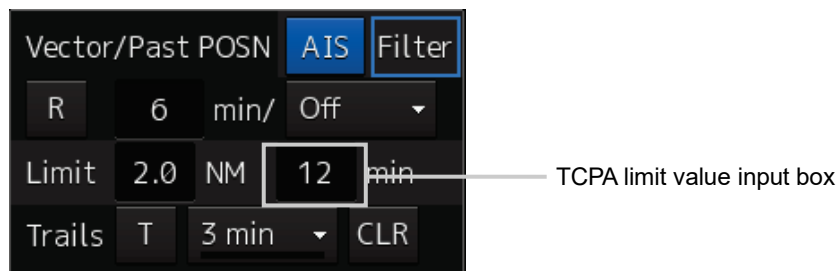

- 2 Enter the TCPA limit.

For the details on how to set up alerts based on the collision determination condition, refer to "12.2 Collision Avoidance Alert Generation Conditions".

6.4.4 Showing the CPA ring

The CPA ring is rendered as a red circle with the own ship centred and the CPA limit set distance used as the radius.

[Operation procedure]

Open the TT/AIS target setting screen by performing the following menu operations.

[Menu] button → View → Target

- 1 Check [CPA Ring (Only Relative mode)].

The CPA ring is shown.

Memo

When True is specified for the vector mode, [CPA Ring (Only Relative mode)] cannot be selected.

6.5 Setting and operating target tracking

The Target Tracking function automatically tracks the acquired targets and records and displays the course and speed of the targets as vector. Alerts can also be output based on the set collision decision criteria (CPA and TCPA).

Memo

At power off and during preparation for transmission, tracking data records are deleted.

6.5.1 Acquiring target

The methods for acquiring targets include AUTO Acquisition (automatic acquisition) mode and ACQ Manual (manual acquisition) mode.

Both modes can also be used concurrently.

6.5.1.1 Automatic acquisition (automatic acquisition) mode

By setting up and enabling the automatic acquisition/activation zone (AZ), targets intruding into the AZ can automatically be acquired/tracked and at the same time, a New Target Warning (automatically acquired target alarm) can be issued.

Memo

If manual acquisition is made in a state in which the number of targets being tracked has reached the maximum number of targets (30, TT option is available :100), the target with the lowest danger level among the targets that have been captured thus far automatically is erased successively. When all the targets that are tracked are for manual acquisition and the number has reached the maximum number of targets, no further acquisition is allowed.

[Operation procedure]

Open the New Target Warning setup screen by performing the following menu operations.

[Menu] button → Alert → New Target Warning

- 1 Enable the automatic acquisition/activation zone (AZ) by checking [Use AZ1] or [Use AZ2].**

Automatic acquisition/activation zone (AZ) includes AZ1 and AZ2.

To enable AZ1, check [Use AZ1].

To enable AZ2, check [Use AZ2].

Memo

For the details of [New Target Warning] dialogue box, refer to "12.3 New Target Warning Generation Conditions".

To automatic acquisition/activation zone (AZ):

Clear the check of [Use AZ1] or [Use AZ2].

AZ can be enabled or disabled by using the [AZ] key on the operation unit also.

For the details of function assignment to the [AZ] key, refer to "13.24 Setting Key Assignment".

6.5.1.2 ACQ manual (manual acquisition) mode

Memo

The manual acquisition mode does not function in the following states.

| State | Action to Take |
|---|---|
| The number of tracked targets has reached the maximum count. | Erase unnecessary targets. |
| The radar antenna is in the standby state. | Start the radar transmission. |
| A PROC (Interrupt) warning is being generated. | Clear the warning. |
| A Gyro (I/F)/Gyro (Data)/Heading (Data) warning is being generated. | |
| The tracked target is located 32 NM away from own ship. | The manual acquisition mode cannot be used. |
| The tracked target is located less than 0.1 NM from own ship. | |

To acquire the tracked target in the manual acquisition mode

- 1 Set the cursor mode to the AUTO mode.**
- 2 Place the cursor on the target to be acquired and then click on.**
The target is acquired and the initial acquisition symbol is displayed.
The vector is displayed within 1 minute.

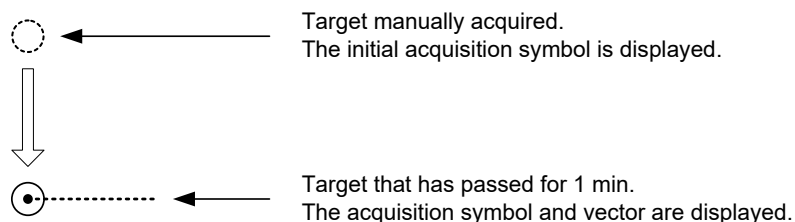

6.5.1.3 Using manual acquisition and AUTO acquisition together

By using manual acquisition with AZ enabled, AUTO acquisition and manual acquisition can be used together. They may be used if a target to which particular attention should be given is manually acquired and other targets are automatically acquired.

6.5.2 Setting up the automatic acquisition/activation zone (AZ)

Auto acquisition/activation zone has the shape of sector set up according to the angle and distance as shown in the following figure.

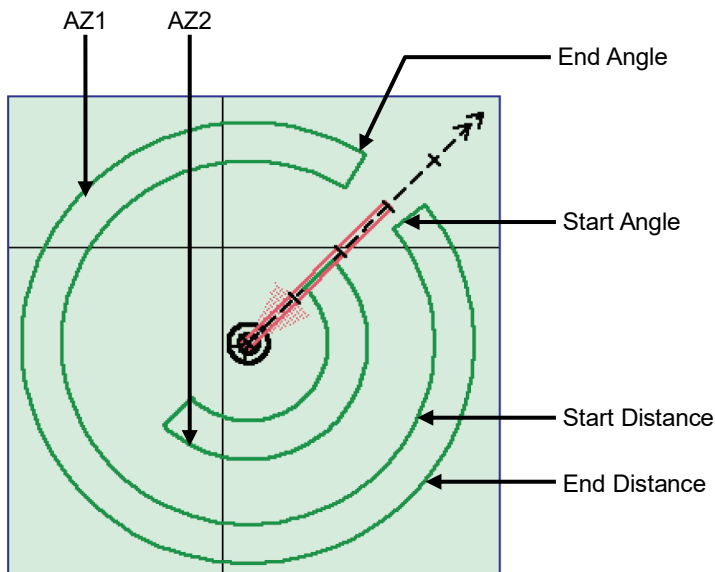

Example of AUTO acquisition/activation zone (AZ)

AUTO acquisition/activation zone (AZ) is set up using the following three methods.

- (1) Set by selecting [Alert] - [New Target Warning].
- (2) Use the cursor.
- (3) Use the EBL/VRM dial.

6.5.2.1 Using [New Target Warning] dialogue box in the [Alert] menu

[Operation procedure]

Open the target acquisition alarm setup screen by performing the following menu operations.

[Menu] button → Alert → New Target Warning

- 1** To set up AZ1, select the [Use AZ1] check box. To set up AZ2, select the [Use AZ2] check box.
- 2** To set up [Use AZ1], click on the [1] tab. To set up [Use AZ2], click on the [2] tab. Their respective setting items are displayed.
- 3** Select [Start Angle], [End Angle], [Start Distance], and [End Distance] of AZ and enter the information from the numeric value input keyboard.

6.5.2.2 Using the cursor

- 1 Select AZ ([Use AZ1] or [Use AZ2]) to be set.**
- 2 Click on the starting azimuth position.**
The starting azimuth is set.
- 3 Move the cursor and click on the ending azimuth position.**
A line connecting the starting azimuth and the ending azimuth is displayed.
- 4 Move the cursor and click at the start distance position.**
An arc appears at the start distance position.
- 5 Move the cursor and click at the end distance position.**
This creates an automatic acquisition/activation zone (AZ) of fan shape that is enclosed by the starting azimuth, the ending azimuth, and the ending distance.

6.5.2.3 Using the EBL/VRM dial for the setting

- 1 Select AZ ([Use AZ1] or [Use AZ2]) to be set.**
- 2 Click on the [Make AZ1] button or the [Make AZ2] button.**
The cursor enters the AZ creation mode.

Make AZ1

- 3 Set [Start Angle] by turning the EBL dial.**
- 4 Set [Start Distance] by turning the VRM dial.**
- 5 Press the EBL dial and the VRM dial.**
- 6 Set [End Angle] by turning the EBL dial.**
- 7 Set [End Distance] by turning the VRM dial.**
- 8 Press the EBL dial.**

6.5.3 Tracked target information display

Memo

When a target or own ship changes its course, or when a new target is acquired, its vector may not reach a given level of accuracy until 3 minutes or more has passed after such course change or target acquisition.

Even if 3 minutes or more has passed, the vector may include an error depending upon the tracking conditions.

- 1 Set the cursor mode to the AUTO mode.**
- 2 Click on the target of tracking whose numerical value is to be displayed.**
 Numeric data for the specified target is displayed in the information monitoring window.
 The symbol display is changed to "⊙". The target data will remain on the radar display until the target is lost and its vector disappears, or until another target is designated.
 If a target with the mark "⊙" is designated, only its true bearing and range appear until its vector appears.

Cancellation of numeric data display

- 1 Set the cursor mode to the AUTO mode.**
- 2 Place the cursor on the tracked target to cancel numeric value display and then click on.**
 The numeric value disappears.

Details on tracked target information

| Item | Explanation |
|---|--|
| TT ID | ID No. of tracked target being displayed |
| BRG | True bearing |
| Range | Distance |
| CTW (Course Through the Water stabilisation mode)/ COG (Course Over the Ground stabilisation mode) | Course |
| STW (Speed Through the Water stabilisation mode) / SOG (Speed Over the Ground stabilisation mode) | Speed |
| CPA | Closest approach distance |
| TCPA | Time up to closest approach distance |
| BCR | Bow crossing distance |
| BCT | Bow crossing time |

6.5.4 Erasing unwanted tracked targets

If the vectors and symbols of the unwanted tracked targets remain displayed, the radar screen may become difficult to view. In such a case, unwanted tracked targets can be erased from the radar screen using the following method.

To erase one target

- 1 Place the cursor on the tracked target to be cancelled and then right-click.**
The context menu is displayed.
- 2 Click on the [Cancel TT] on the context menu.**
The vector symbol of the tracked target disappears and only the radar image remains.

To erase multiple targets

- 1 Place the cursor on the tracked target to be cancelled and then right-click.**
The context menu is displayed.
- 2 Click on the [Cancel TT mode] on the Context menu.**
The cursor changes to the selection cursor.
- 3 Place the cursor on another target to be cancelled and then click on.**
- 4 Repeat the operation in step 3.**
The vector symbols of the clicked tracked targets disappear and only the radar image remains.
Finish the cancel TT mode by clicking the right mouse button.

To erase all targets

- 1 Place the cursor on the tracked target to be cancelled and then right-click.**
The context menu is displayed.
- 2 Click on the [Cancel All TT] on the context menu.**
The vector symbols of all the tracked targets disappear and only the radar image remains.

Memo

If all targets are cancelled, the tracking of all targets will stop; thus, automatic acquisition or manual acquisition must be performed newly. Unless necessary, do not cancel all targets.

6.5.5 Displaying target ID No.

A target ID number is a value displayed beside the acquisition symbol when a target is acquired.

A target ID number 1 to 30 is automatically assigned to each target in acquisition order. Once a target ID number is assigned, it identifies the target until the target is lost or the target acquisition is cancelled.

Memo

The ID number is always displayed for only targets with which numeric data is displayed.

[Operation procedure]

Open the TT/AIS target setup screen by performing the following menu operations.

[Menu] button → View → Target

1 Select an ID number display method from the [TT Target ID] list.

[Off]: Hides target ID numbers.

[On]: Displays target ID numbers.

[TT Track]: Displays ID numbers of only targets set for track of other ships.

[Ship's Name]: If the ship's name has been input in the [TT Target INFO] dialogue, the ship's name is displayed. If the ship's name has not been input, the identification number is displayed.

Memo

If there are many tracking targets and their symbol display is confusing, set Target Number Display to off to view the radar display easily.

6.5.6 Editing tracked target properties

The tracked target property such as tracked target ID name can be arbitrarily edited for individual tracked targets acquired.

The [TT Target INFO] dialogue is used for editing.

The following items are displayed.

| Item | Description |
|------------------|--|
| Target ID | Tracked target ID appears. |
| Name | Enter the tracked target ID name. |
| Edit Template | The tracked target ID name that was entered in [Name] is set. For the details, refer to "6.5.6.1 Adding tracked target ID name". |
| Track Colour | The track colour of tracked target is set. For the details, refer to "6.5.6.2 Setting track colour of tracked target". |
| Reference Target | The target for which ground is fixed is set to a reference target. For the details, refer to "6.5.7 Setting target for which ground is fixed to a reference target" |
| Priority | When a TT target and AIS target are determined to be the same targets, the TT target or AIS target to be displayed on a priority basis can be set. For the details, refer to "6.3.8 Association target symbols" |

6.5.6.1 Adding tracked target ID name

An ID name can be added to the tracked target acquired.

1 Right-click the cursor on the tracked target.

The context menu is displayed.

2 Click on [Property] on the context menu.

The [TT Target INFO] dialogue box appears

3 Click on the [Name] input box or ▼ .

The input method varies with the selected item.

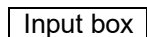

: Enter a new name.

When selected, the ship name ([Name]) entry window opens.

Enter a ship name of up to 15 characters.



: The names registered as templates are displayed in a list.

Select a name from the list.

To register ship names as templates

1 Click on the [Edit Template] button in the [TT Target INFO] dialogue.

The [Template] dialogue is opened.

2 Enter the ship name to be registered as a template in the input text box.

3 Click on the [Register] button.

The entered ship name is registered in the template list.

4 Repeat steps 2 and 3, and register necessary ship names.

To cancel unwanted ship name registration

1 Check the ship's name whose registration is to be cancelled on the template list in the [Template] dialogue.

2 Click on the [Delete] button.

The checked ship name is deleted from the template list.

6.5.6.2 Setting track colour of tracked target

The track colour of tracked target is set.

1 Right-click on the cursor at the tracked target.

2 Click on the [Property] on the context menu.

The [TT Target INFO] dialogue box appears.

3 Select a track colour from the [Track Colour] list.





The selection items are as follows.

Off, No.1-Colour, No.2-Colour, ... , No.10-Colour, No.11 to 20-Colour, No.21 to 30-Colour, ..., No.91 to 100-Colour

* In [Colour], the track colour name that was set by selecting menus, [View] - [Target Track] - [Plot] tab is displayed. For the details, refer to "11.1.7 Setting up the Display of Other Ship's Track".

6.5.7 Setting target for which ground is fixed to a reference target

By tracking the target for which ground is fixed and setting it to a reference target, the speed of the own ship can be obtained and displayed.

|  WARNING | |
|--|--|
|  | The reference target function is to be used if the own ship's speed cannot be displayed normally due to trouble such as a speed sensor malfunction. Do not use the reference target function except in emergencies. |
|  | Do not set as a reference target a large radar echo such as a land target. The vectors of the speed and other tracking targets will not be displayed correctly and may cause an accident. |
|  | Do not set as a reference target a sailing ship. The vectors of the speed and other tracking targets will not be displayed correctly and may cause an accident. |
|  | Do not use own speed based on reference target tracking for relative speed and CPA/TCPA calculation of AIS targets because the response of own speed is slower than actual own ship's speed change and it may cause a big error on the collision judgement of AIS targets. |

1 Acquire the ground-fixed target.

2 Click the right button on the acquired target.

A context menu is displayed.

3 Click on [Property] in the context menu.

The [TT Target INFO] dialogue is opened.

4 To set the target to a reference target, check [Reference Target].

To not set the target to a reference target, uncheck [Reference Target].

5 Select [TGT] from the COG/SOG source combo box in the own ship information at the top right corner of the screen.

The ship speed is automatically calculated from the reference target and is displayed as the COG/SOG speed.

When a reference target is set, the symbol display changes to “”.

Memo

- If the speed or course of the own ship is changed or a new reference target is set, the displayed speed may take 3 minutes or more to reach the specified speed after the speed/course change or the setting.
Even after 3 minutes or more has passed, the speed may differ from the specified speed depending on the tracking condition.
- If the reference target is lost or the Target Tracking function is stopped, the ship speed against the ground will be GPS. (Only if the GPS is equipped.)
- If the reference target is lost or the Target Tracking function is stopped, that will make a major impact on the accuracy of the target tracking and the own ship speed.
- The reference targets are only used for the calculation of true speed.
- Only one target can be set as a reference target. When a new reference target is set, the previous reference target is cancelled.

6.5.8 Operation test for target tracking

CAUTION



Simulation is a function for determining if the target tracking function is working correctly or not. Accordingly, this function should be used only to check for the target tracking function operation.

In particular, if this mode is used during navigation, a pseudo target will appear on the radar screen and cannot be easily identified from the real target. This may cause such an accident as collision. Do not use this mode during the navigation.

The following operation test and checking are performed to check the operation of target tracking as required. The [TT Test] dialogue is used for operation.

[Operation procedure]

Open the Target Tracking Test dialogue by performing the following operations.

[Menu] button → Settings → TT Test

6.5.8.1 [Test Video]

Test Video is used to check whether the video signals under target acquisition and tracking are input to and processed in the target detection circuit normally.

Normally, it is sufficient to just check that the VDIN of the Test Video is displayed.

Memo

Test Video may not be displayed for a target which is not yet acquired or tracked. Test Video may not be displayed either if the [GAIN] dial or [SEA] dial is not properly adjusted.

1 Select test video to be displayed from the [Test Video] combo box.

The selected test video is displayed in the rearward of the radar image.

If any target displayed clearly in the normal radar display is not displayed in the Test Video mode, the target detection circuit of the Target Tracking unit may have a trouble.

To cancel test video**1 Select [Off] from the [Test Video] combo box.**

Test Video display turns off.

6.5.8.2 [TT Simulator] (Target tracking simulator)

Pseudo-targets are generated in certain known positions to check whether the target tracking units are operating normally. Since the pseudo-targets move depending on known parameters, the values for these pseudo-targets can be compared with the known value if the pseudo-targets are acquired and tracked, and displayed. Thus, it can be checked if the system is operating normally.

- 1 Click on the Standby/Transmit selector button for Radar system information to place the radar in the standby state.

The button indication changes to [Standby].

- 2 Select simulator scenario from the [TT Simulator] combo box.

List of target tracking simulator/scenario

| Scenario | Target No. | Motion (true motion) | Moving start point | | |
|------------|------------|-------------------------|--------------------|------------|-------------|
| | | Speed [kn] | Course [°] | Range [NM] | Bearing [°] |
| Off | - | - | - | - | - |
| Scenario 1 | 1 | 28.3 | 45 | 9.5 | 270 |
| | 2 | 22.4 | 27 | 1.12 | 333 |
| | 3 | 15.3 | 293 | 9.25 | 45 |
| Scenario 2 | 1 | 30 | 135 | 8 | 23 |
| | 2 | 20 | 270 | 5 | 135 |
| Scenario 3 | 1 | 45 | 180 | 5 | 23 |
| | 2 | 0 | - | 3 | 340 |
| | 3 | 30 | 0 | 8 | 180 |
| Scenario 4 | 1 | 0 | 0 | 2.02 | 31 |
| | 2 | 70 | 225 | 7.01 | 37 |
| Scenario 5 | 1 | 20 | 45 | 4.47 | 288 |
| | 2 | 30 | 45 | 5.1 | 304 |
| | 3 | 40 | 45 | 6.71 | 288 |
| | 4 | 0 | - | 7.07 | 307 |
| | 5 | 60 | 200 | 12 | 352 |
| | 6 | 20 | 225 | 11 | 315 |
| | 7 | 40 | 190 | 14.4 | 349 |
| | 8 | - | - | 8 | 318 |
| | 9 | - | - | 9 | 318 |
| | 10 | - | - | 10 | 318 |
| Scenario 6 | 1 | 5 | 96 | 5 | 0 |
| | 2 | 105 | 225 | 6 | 45 |

Memo

When the simulator is operating, set 0° as the heading bearing

- 3 Click on the Standby/Transmit selector button to place the radar in the transmission state.

The button indication changes to [Transmit]. The simulator turns on, the pseudo-target is generated, and the letter "X" appears on the lower side of the radar screen and near the pseudo-target to indicate that simulation mode is being executed.

To cancel simulation

- 1 Click on the Standby/Transmit selector button to place the radar in the standby state.**
The button indication changes to [Standby] to enter transmission preparation state.
- 2 Select [Off] from the [TT Simulator] combo box in the [TT Test] dialogue.**
TT Simulator display turns off.

6.5.8.3 [Gate Display]

The gate displays an area monitoring a target using the TT function. This equipment allows the gate size to change automatically according to target range and size. The gate size can be checked using the following function.

- 1 Select the [Gate Display] checkbox.**
When [Gate Display] is selected, the gate is displayed.
When [Gate Display] is cleared, the gate is not displayed.
- 2 Set the cursor mode to the AUTO mode.**
- 3 Click on the target of tracking whose numerical value is to be displayed.**
Numeric data for the specified target is displayed in the information monitoring window.
The numeric value for the target is displayed, and the gate is displayed in green around the target tracking symbol.

Memo

The Target Tracking can display the gate of two targets simultaneously.

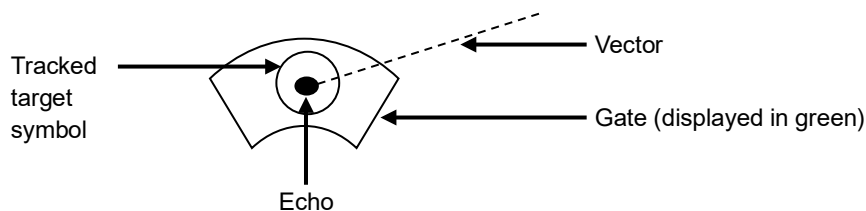

6.5.8.4 [Status] display

The status of the TT function is displayed.

- 1 Check the display of [Status].**

| | |
|--------------------------|--|
| [Vector Constant] | : Vector response |
| [VD Level Mode (Manual)] | : Using quantization level on manual acquisition |
| [VD Level (Manual)] | : Quantization level on manual acquisition |
| [Video Level (AUTO)] | : Quantization level on automatic acquisition |
| [Gate Size] | : Size of gate used for tracking |
| [Tracking] | : Number of targets currently acquired |

6.6 Setting and operating AIS

6.6.1 Enabling AIS function

Memo

- When the AIS function is set to Off, the AIS display function is turned off and AIS symbols are no longer displayed.
- Once AIS function is set to Off, even if a dangerous target exists, the function is not automatically switched to On.

- 1 Click on the [AIS] button for other ship information on the upper right of PPI.

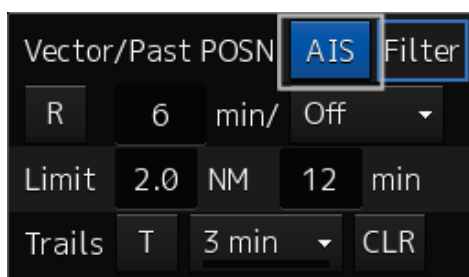

The button indication becomes ON and the AIS function becomes enabled.

ON indication: 

The received AIS information is displayed on the screen.

6.6.2 Activating AIS targets (Activate AIS)

Activates an AIS target, and displays the target's vector and make a collision decision.

6.6.2.1 Manual activation

Activates an AIS target in manual mode to display the vector and heading line.

- 1 Set the cursor mode to the AUTO mode.
- 2 Place the cursor on the sleeping AIS symbol to be activated and then click on.
The selected AIS target is activated.

6.6.2.2 Automatic activation

Activate an AIS target in automatic mode to display the vector and heading line.

When the automatic activation function is used, AIS targets are automatically activated when they go into the automatic activation zone. The automatic activation zone is identical to the automatic acquisition zone (AZ) used for target tracking. For the zone setting, refer to "6.5.1.1 Automatic acquisition".

Memo

- When the AIS target's symbol is activated but the vector is not displayed, the following are probable causes of the trouble:
 - COG/SOG is not input yet from the GPS.
 - The selected speed sensor is malfunctioning.
- The bearing or range in the acquisition/activation zone shall be based on the position of the radar antenna.
- If there are more AIS targets than the allowable maximum, they are deactivated from the low-priority (Refer to "6.3 Displaying Symbols").

6.6.3 Deactivating AIS targets

Deactivates an AIS target and clear the display of the vector and heading line.

[Deactivating one AIS target]

- 1 Right-click on the AIS target to be deactivated.**
The setting items for cursor modes are displayed.
- 2 Click on the [Deactivate] on the Context menu.**
The selected AIS target is deactivated.

[Deactivating multiple AIS targets]

- 1 Right-click on the AIS target.**
The setting items for cursor modes are displayed.
- 2 Click on [Deactivate mode] on the Context menu.**
The cursor changes to the selection cursor.
- 3 Click on the AIS target to be deactivated.**
The selected AIS target is deactivated.

Memo

This operation is available only for an activated AIS target.

6.6.4 Displaying AIS information

- 1 Set the cursor mode to the AUTO mode.
- 2 Place the cursor on the AIS target to display the activated AIS target information and then click on.

The information of the selected AIS target is displayed.

Memo

When the numeric data of a target is displayed but the mark " [] " is not on the radar display, the target is outside the display.

Canceling AIS target information display

- 1 Set the cursor mode to the AUTO mode.
- 2 Move the cursor to and click on the activated AIS target whose AIS target information is to be cancelled.

The information display of the selected AIS target is cancelled.

Details on AIS target information

Two AIS target information display modes are available, a standard mode, and an extended mode, and the items that are displayed vary depending on the mode.

Use the AIS Standard/Extended selector button for switching between the standard mode and the extended mode.

By setting the display to  by clicking on the AIS Standard/Extended selector button, an extended mode can be set. By setting the display to  by clicking on the button again, a standard mode can be set.

The display contents vary depending on the types of AIS targets.

For verifying more detailed information of the AIS target, refer to "2.3.1.4 AIS Detail INFO".

[Normal AIS target]

| Item | Explanation |
|------------|---|
| AIS ID | ID No. of AIS target |
| Name | Ship name of AIS target |
| Call Sign | Call sign of AIS target |
| MMSI | Maritime Mobile Service Identity |
| COG or CTW | COG: Course Over the Ground CTW: Course Through Water * In ground mode, COG is displayed. In water mode, CTW is displayed. |
| SOG or STW | SOG: Speed Over the Ground STW: Speed Through Water *If the SOG or STW column is Over, the speed of other system is 102.2 kn or more. * In extended mode, the display area for two simple modes is used. |
| CPA | Closest approach distance |
| TCPA | Time up to closest approach distance |

| Item | Explanation |
|-------------------|--|
| BRG | True direction * In standard mode, this item is not displayed. |
| Range | Distance * In standard mode, this item is not displayed. |
| Heading | Heading * In standard mode, this item is not displayed. |
| ROT | Rate of turn * In standard mode, this item is not displayed. * The display range of ROT is 0.00°/min to 697.50°/min. In the case of Over, the value will be greater. In the case of $\pm 5/30s$, it indicates that ± 127 is received. At this time, only turning direction indicated on the turn indicator is reliable. The turn indicator is displayed as a straight line normal to the heading direction on the AIS symbol. (Refer to "6.3 Displaying Symbols.") |
| POSN | Latitude/longitude * In standard mode, this item is not displayed. |
| >10m or <10m | >10m: Low positioning accuracy <10m: High positioning accuracy * In standard mode, this item is not displayed. |
| Destination | Destination * In standard mode, this item is not displayed. |
| Navigation Status | The status is displayed by number. For the details, refer to "Navigation Status" table. * In standard mode, this item is not displayed. |

Memo

In the extended mode, a display area equivalent to two standard mode areas is used.

Navigation Status

| Status |
|-------------------------------|
| 0: Under Way Using Engine |
| 1: at Anchor |
| 2: Not Under Command |
| 3: Restricted Manoeuvrability |
| 4: Constrained by Her Draught |
| 5: Moored |
| 6: Aground |
| 7: Engaged in Fishing |
| 8: Under Way Sailing |
| 9: Reserved for HSC |
| 10: Reserved for WIG |
| 11-14: Reserved |
| 15: Not Defined |

[AIS SART Target]

Neither a call sign nor a destination item is available. Displays of some items of the navigation status are different. For the other items, the display contents are the same as those of usual AIS target.

Navigation Status

| Display |
|--|
| 0 ~ 13: Same display as for the usual ship |
| 14: AIS-SART ACTIVE(14) |
| 15: AIS-SART TEST(15) |

Memo

Switching between standard and extended modes is not provided.

[AIS AtoN Target]

| Item | Description |
|---------------|---|
| AIS ID | AIS target ID |
| Name | Ship name of AIS target |
| MMSI | Maritime Mobile Service Identity code |
| BRG | True bearing |
| Range | Range |
| POSN | Latitude/longitude |
| >10m or <10m | >10m: Position fixing accuracy low <10m: Position fixing accuracy high |
| Type | Displays the AtoN type. For the details, refer to the "Type" table. * Not displayed in standard mode. |
| Virtual Flag | Real AtoN: Real AtoN Virtual AtoN: Virtual AtoN (does not exist) * Not displayed in standard mode. |
| Assigned Mode | Autonomous and continuous: Operating in autonomous/continuous mode Assigned: Operating in assignment mode * Not displayed in standard mode. |
| EPFS | Displays the EPFS type. For the details, refer to the "EPFS" table. * Not displayed in standard mode. |

| Type | EPFS |
|--|---------------------------------|
| Display | Display |
| Not Available | 0:Undefined |
| 1:Reference point | 1:GPS |
| 2:RACON | 2:GLONASS |
| 3:Fixed structure off shore | 3:combined GPS/GLONASS |
| 4:Emergency Wreck Marking Buoy | 4:LORAN-C |
| 5:Light,without sectors | 5:Chayka |
| 6:Light,with sectors | 6:Integarated Navigation System |
| 7:Leading Light Front | 7:surveyed |
| 8:Leading Light Rear | 8:Galileo |
| 9:Beacon,Cardinal N | 15:internal GNSS |
| 10:Beacon,Cardinal E | 9-14:not used |
| 11:Beacon,Cardinal S | |
| 12:Beacon,Cardinal W | |
| 13:Beacon,Port hand | |
| 14:Beacon,Starboard hand | |
| 15:Beacon,Preferred Channel port hand | |
| 16:Beacon,Preferred Channel starboard hand | |
| 17:Beacon,Isolated danger | |
| 18:Beacon,Safe water | |
| 19:Beacon,Special mark | |
| 20:Cardinal Mark N | |
| 21:Cardinal Mark E | |
| 22:Cardinal Mark S | |
| 23:Cardinal Mark W | |
| 24:Port hand Mark | |
| 25:Starboard hand Mark | |
| 26:Preferred Channel Port hand | |
| 27:Preferred Channel Starboard hand | |
| 28:Isolated danger | |
| 29:Safe Water | |
| 30:Special Mark | |
| 31:Light Vessel /LANBY/Rigs | |

6.6.5 Displaying Target ID No.

When an AIS target is activated, a target ID number is displayed next to the AIS target symbol. A target ID number 1 to 180 is assigned to each target in the order of receiving targets by MFD. Once a target ID number is assigned, it identifies the AIS target until the AIS target is lost.

[Operation procedure]

Open the TT/AIS target display setup screen by performing the following menu operations.

[Menu] button → View → Target

1 Select an ID number display method from the [AIS Target No.] combo box.

[Off] : Hides target ID numbers.

[On] : Displays target ID numbers.

[AIS Track] : Displays ID numbers of only targets set for track of other ships.

[Ship's Name] : Displays the ship's name.

Memo

- ID number or ship's name is always displayed for only targets with which numeric value is displayed.
- If there are many AIS targets and their symbol display is confusing, set Target Number Display to off to view the radar display easily.

6.6.6 Checking and setting AIS target property

The AIS target property such as ID name can be checked for individual acquired AIS targets.

The track colour of AIS target can also be set.

The [AIS Target INFO] dialogue is used for editing.

The following items are displayed.

| Item | Description |
|--------------|---|
| Target ID | AIS target ID appears. |
| Name | AIS target ID name appears. |
| Track Colour | The track colour of AIS target is set. For the details, refer to "6.6.6.1 Setting track colour of AIS target". |
| Priority | When a TT target and AIS target are determined to be the same targets, the TT target or AIS target to be displayed on a priority basis can be set. For the details, refer to "6.3.8 Association Target Symbols". |

6.6.6.1 Setting track colour of AIS target

The track colour of AIS target is set.

1 Right-click on the AIS target.

The context menu is displayed.

2 Display [Property] on the context menu.

3 Select a track colour from the [Track colour] combo box.

The selection items are as follows.

Off, No.1-Colour, No.2-Colour, ..., No.10-Colour, No.11 to 20-Colour, No.21 to 30-Colour, ..., No.91 to 100-Colour

* In [Colour], the track colour that was set by selecting [View] - [Target Track] - [Plot] tab on the menus is displayed. For the details, refer to "11.1.7 Setting the Display of Other Ship's Track".

6.6.7 Conditions for deciding AIS target to be lost

About an AIS target lost

When the data of a target cannot be received for a specified time, the target is decided to be lost and the target data is deleted. As shown in the table below, the time until target data is deleted varies depending on the class of received data and the target status.

| Memo | |
|------|--|
| • | Since the lost time and that of the AIS indicator are different, this equipment may display lost information earlier than the AIS display depending on the target status (speed, navigation status, etc.). |
| • | The target of lost target is continuously displayed until Lost Warning is approved. Since negligence of approval operation may hinder display of a new AIS target, perform approval operation as soon as possible. |
| • | When a dangerous target ship is lost, a lost alarm is issued and the symbol changes to a lost symbol. The system calculates the current position from the last-received data and continues displaying the symbol for eternity. |
| • | When the [AIS] button in the target ship information window is turned off, the symbol is cancelled. |

Conditions for Deciding Target to be Lost 1

| Target status | Time until data is lost | | |
|---|-------------------------|-----------------------------|-------------------------|
| | SOLAS ship (Class A) | Non-SOLAS ship (Class B) | |
| | | CS (Carrier Sense) | SO (Self Organising) |
| Vessel below 3 kn (Class A) or 2 kn (Class B) and it is now at anchor or on the berth | 18 min | 18 min | |
| Vessel of more than 3 kn and it is now at anchor or on the berth | 60 sec | - | |
| Vessel of 0 to 14 kn (Class B: 2 to 14 knots) | 60 sec | 180 sec | |
| Vessel of 0 to 14 kn and it is now changing the course | 60 sec | 180 sec | |
| Vessel of 14 to 23 knots | 36 sec | 180 sec | 90 sec |
| Vessel of 14 to 23 kn and it is now changing the course | 36 sec | 180 sec | 90 sec |
| Vessel of more than 23 kn | 30 sec | 180 sec | 30 sec |
| Vessel of more than 23 kn and it is now changing the course | 30 sec | 180 sec | 30 sec |

Conditions for Deciding Target to be Lost 2

| Target status | Time until data is lost | |
|---|-------------------------|--------|
| AtoN (Aids to navigation) | 18 min | 18 min |
| SART | 6 min | 6 min |
| AIS SAR aircraft (fixed wing, helicopter) | 60 sec | 60 sec |
| AIS coastal base station | 60 sec | 60 sec |

6.7 Alert Display

Target tracking and AIS system have the following alerts.

| Message | Description |
|--------------------|---|
| AIS 95% Capacity | The number of AIS targets reached 95% of tolerance. |
| AIS MAX Capacity | The number of AIS targets reached the maximum number of targets displayed. |
| CPA/TCPA(AIS) | CPA/TCPA warning (AIS) |
| CPA/TCPA(TT) | CPA/TCPA warning (TT) |
| Lost AIS Target | The AIS target was lost. |
| Lost TT REF Target | The referential TT target was lost. |
| Lost TT Target | Acquired TT was lost. |
| New AIS Target | The AIS target was acquired and activated. |
| New TT Target | TT was acquired. |
| On Trial(CPA/TCPA) | Under the trial process. Occurs instead of a danger target alarm when the predicted route of the tracking target intersects with the CPA/TCPA limit range |
| TT 95% Capacity | The number of TT targets reached 95% of tolerance. |
| TT MAX Capacity | The number of TT targets reached the maximum number of targets. |
| TT(Out of Range) | TT went out of 32NM. |

An alert is displayed in the alert notification area.

6.7.1 Danger target alarm (CPA/TCPA)

WARNING



Since these alarms may include some errors depending on the target tracking conditions, the navigation officer himself should make the final decision for ship operations such as collision avoidance.



Making the final navigation decision based only on the alarm may cause accidents such as collisions.

In this system, targets are categorized into two types: tracked targets and dangerous targets depending on the danger level. The danger level can easily be recognised on the display. So, it is easily possible for the ship operator to judge which target is to be cautious about.

The danger target symbol of the tracked target will be displayed until either the tracking is stopped or the conditions no longer apply.

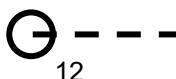

The types of target and alarm are shown below.

Dangerous Target Alarm

| Status | Symbol on display | Alert characters | Alarm sound | Conditions |
|----------------------|---|------------------|--|---|
| Tracked target |  | (Off) | (Off) | <ul style="list-style-type: none"> • CPA > CPA Limit • 0 > TCPA • TCPA > TCPA Limit |
| Activated AIS target |  | | | |
| Dangerous target |  Red blinking | CPA/ TCPA | Beep sound (beep-beep-beep) Alarm acknowledgeable | <ul style="list-style-type: none"> • CPA ≤ Limit • 0 ≤ TCPA ≤ TCPA Limit <p>An alarm is issued when all the conditions are met. The sleeping AIS targets will be activated.</p> |

CPA Limit and TCPA Limit: Setting Values

6.7.2 Warning for new target acquired in automatic acquisition guard zone (New target)

| | |
|--|---|
|  WARNING | |
|  | <p>In setting an automatic acquisition guard zone, it is necessary to adjust the gain, sea clutter suppression and rain/snow clutter suppression to ensure that target echoes are displayed in the optimum conditions.</p> <p>No automatic acquisition guard zone warnings will be issued for targets undetected by the radar, and this may cause accidents such as collisions.</p> |

The automatic acquisition function sets a zone in a range and issues a warning when a new target (which is not yet acquired) goes into this zone.

For the setting of an automatic acquisition guard zone, refer to "6.5.1 Acquiring target".

Warning for New Target Acquired in Automatic Acquisition Guard Zone

| Status | Symbol on display | Alert characters | Alert sound | Conditions |
|--|---|------------------|---|--|
| New target in automatic acquisition guard zone |  Red Blinking | New Target | Beep sound (beep-beep) Alert acknowledgeable | The warning is issued when a new target is acquired in the automatic acquisition guard zone. |

Memo

When an already acquired target goes into automatic acquisition guard zone, the warning for the new target acquired in automatic acquisition guard zone does not sound.

6.7.3 Lost target warning (Lost)

Memo
 If the gain, sea clutter suppression, rain/snow clutter suppression are not adjusted adequately, the lost target warning may be easily generated. So, such adjustments should be very carefully.

When it is impossible to continue tracking any acquired and tracked target, or the data of AIS target cannot received for a specified time, the [Lost] warning will be issued. The typical causes for warning are shown below:

- The target echo is very weak.
- The target is hidden by a shore or a large ship and its echo is not received.
- The target echo is blurred by sea clutter or rain/snow clutter.

If a target under tracking goes into a range over 32 NM and can no longer be tracked, it is cancelled without a lost target warning being issued.

Lost Target Warning

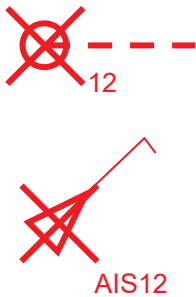
| Status | Symbol on display | Alert characters | Alert sound | Conditions |
|-------------|--|------------------|---|---|
| Lost target |  Red Blinking | Lost | Beep sound (beep-beep) Alert acknowledgeable | The warning will sound once when a lost target symbol is displayed. |

6.7.4 Target Tracking function alarm (TT Data)

If some failure occurs in input signals or the processor circuits, an alarm will be issued. If an alarm is issued in the Target Tracking function, [TT(Data)] is displayed in the alert notification area and nothing is displayed in the indication of the target tracking information. Its cause is inferred that the Target Tracking function is malfunctioned. In that case, please consult with our branch office, branch shop, sales office, or our distributor in your district to repair it.

Target Tracking function Alarm

| Alert characters | Alarm sound | Condition |
|------------------|-------------------|---|
| TT (Data) | Beep sound (pipi) | If the Target Tracking function has some abnormal condition, this alarm issues. |

6.7.5 Gyro set notification (Set Gyro)

The GYRO I/F receives signals from a gyro. Even if the power is turned off, the system will follow up the gyro. However, the system stops the follow-up operation when the power of the master gyro is turned off or when any trouble occurs to the line. When the power of the master gyro is recovered, the [Set Gyro] notification will be issued.

When this notification is issued, set the true bearing value of the gyro. For the details, refer to “5.4.13 Setting true bearing”.

Gyro Set Notification

| Alert characters | Alarm sound | Conditions |
|------------------|------------------|---|
| Set Gyro | Beep sound (pi-) | The signals from the gyro are stopped, but the gyro is recovered. |

6.8 Track Function

6.8.1 Setting the past position

- 1 Select the track display interval time from the past position interval selector combo box for other ship information at the upper right of PPI.

The past position is set.

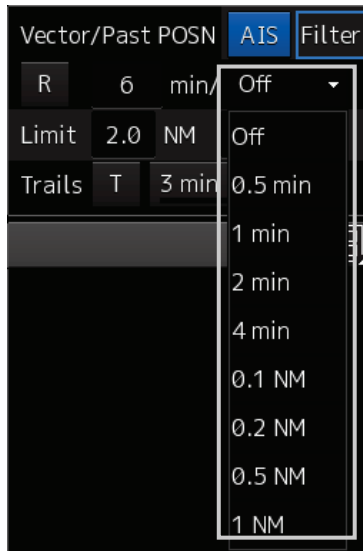

[Off] : Tracks are not displayed.

[Numeric] : Tracks are displayed at intervals of the specified value.

The past position function can display up to ten past positions of a target under tracking. The past position display interval can be set to specified time intervals of 0.5, 1, 2, or 4 minutes, or specified range intervals of 0.1, 0.2, 0.5, or 1 NM.

When [Off] is displayed, the track display function is turned off.

The track mode operates in conjunction with the vector mode, and a true or relative track is displayed.

In relative vector mode, the relative tracks of the target are displayed.

In true vector mode, true tracks that are calculated from the relative bearing, range, own ship's course, and speed are displayed.

Memo

When the target is acquired, past position of traced target is start plot. When the AIS target is displayed, past position of AIS target is start plot. If the past position plotted time or range is short, the indicated past position duration may not have achieved the specified time or range.

6.8.2 Setting the other ship's tracks

This function makes settings for the tracks of tracked targets and AIS targets.

This equipment can display the tracks of up to 30 target ships.

6.8.2.1 Setting track colour

For the details on how to set the track colour of tracked target, refer to "6.5.6.2 Setting track colour of tracked target". For the details on how to set the track colour of AIS target, refer to "6.6.6.1 Setting track colour of AIS target"

6.8.2.2 Turning on/off other ship's track function

For the details, refer to "13.13 Setting the Target Track Function to ON/OFF".

Memo

Note that when this function is turned off, all the other ship's track functions are turned off. In this case, the track data of other ships is not saved, so they cannot be traced later.

6.8.2.3 Setting other ship's track colours

You can set either one track colour for all targets under tracking, or individual colours for the ships of track numbers from 1st to 10th. For the ships from the 11th ship, a colour can be set and displayed for every 10 ships. For the details, refer to "11.1.7 Setting up the Display of Other Ship's Track".

Memo

If the other ship's track function (Target Track Function) is turned off, the track data of other ships is not saved.

6.8.2.4 Turning on/off other ship's track display

The target track display function can be turned on/off. Choices for track display are displaying/hiding the tracks of all ships and Individual (displaying the tracks of individual ships).

For the details, refer to "11.1.7 Setting up the Display of Other Ship's Track".

Memo

Even when Target Track Display is turned off, the track data of other ships is saved if Track display Interval is set.

6.8.2.5 Setting up the display interval of other ship's track

A display interval of other ship's track can be set.

For the details, refer to "11.1.7 Setting up the Display of Other Ship's Track".

Memo

This function is not available when the Target Track Function is turned off.

6.8.2.6 Clearing other ship's track

The other ship's track can be cleared by setting a colour or a track number.

For the details, refer to "11.1.7 Setting up the Display of Other Ship's Track".

6.8.2.7 Saving and loading other ship's track data

Other ship's track data can be saved on HDD and load from the HDD.

(Data can be saved to HDD until the data volume becomes full.)

For the details, refer to "3.23.1 File management".

6.9 Entering Own Ship's AIS Voyage Data

Set the own ship's AIS voyage data.

[Operation procedure]

Open the AIS voyage information setup screen by performing the following menu operations.

[Menu] button → TT/AIS → AIS Voyage Data

- 1 Since the information that was retrieved from AIS is displayed in the [AIS Voyage Data] dialogue, input the information that is not displayed or change the information that is displayed.

| Item | Setting |
|-------------------------------|--|
| Destination (Input box) | Enter the destination in the [Destination] input box (maximum 20 characters), or display the history list and click on the destination to enter. |
| Destination (History list) | |
| ETA (UTC) | Click on the calendar icon  to display the date picker, and enter the expected date (and time) of arrival by clicking. |
| NAV Status | Select from the combo box. For the details, refer to the [Navigation Status] table in "6.6.4 Displaying AIS information". |
| Draft | Enter draft in the input box within the range from 0 to 25.5 m. The draft can be entered in increments of 0.1 m. If the draft is more than 25.5 m, enter 25.5 m. |
| Cargo Cat. | Select the cargo category from the combo box. Category X (DG/HS/MP) Category Y (DG/HS/MP) Category Z (DG/HS/MP) Category OS (DG/HS/MP) No Additional Information All Ships of This Type Not Available |
| Person On-Board | Enter the number of crew members in the input box within the range from 0 to 8191. When the number of crew members is more than 8191, enter 8191. |

- 2 Click on the [Send] button to save the input information.

6.10 Editing and Sending AIS Messages

AIS messages can be edited and sent.

[Operation procedure]

Open the AIS message screen by performing the following menu operations.

[Menu] button → TT/AIS → Edit and Send AIS Message

- 1 Specify whether [Addressed] (transmit a message by specifying an MMSI code) or [Broadcast] (distribute a broadcast message) is applied.**

For the details, refer to "To send a message by specifying an MMSI code:" and "To distribute a broadcast message:"

- 2 Display the [Category] list, then select a category of the message to be transmitted.**

To send a safety related message: Click on [Safety Message].

To send a routine message: Click on [Routine Message].

- 3 Type a message in the message input area.**

To automatically enter own ship's latitude/longitude/UTC:

Click on the [LL & Time] button.

To copy an existing message: Display the contents of the AIS message tray by clicking on the [View Tray] button. Select a message to be copied and copy the message. The contents from the beginning to the maximum number of characters can be copied.

Memo

The maximum number of characters that can be input changes depending on the transmission method and the message type.

- Sending a message by specifying the MMSI code
 - Safety message: Up to 156 characters
 - Routine message: Up to 151 characters
- Distributing a broadcast message
 - Safety message: Up to 161 characters
 - Routine message: Up to 156 characters

- 4 Click on the [Send] button to send the message.**

The message transmission confirmation dialogue box appears.

- 5 Click on the [OK] button to send the message.**

To cancel the transmission of the message, click on the [Cancel] button.

The transmission of the message currently in progress can be stopped by clicking the [Cancel] button.

At transmission completion, a transmission completion dialogue is displayed.

- 6 Click on the [OK] button to close the dialogue box.**

-
-
- 7** To save an MMSI code and a typed message in the case of MMSI transmission, click on the [Save] button.
 - 8** Click on the [x] button to close the dialogue box.

To send a message by specifying an MMSI code:

- 1** Select the [Addressed] radio button.
- 2** Type an MMSI code (9 digits) in the [MMSI] input box.
The name of the ship having the entered MMSI code is displayed in the [Name] box.
The identification number is displayed in the [Target ID] box.
- 3** Type a message in the message input area.
In the case of a safety related message: Maximum 156 characters
In the case of a routine message: Maximum 151 characters

To distribute a broadcast message:

- 1** Select the [Broadcast] radio button.
- 2** Type a message in the message input area.
In the case of a safety related message: Maximum 161 characters
In the case of a routine message: Maximum 156 characters

6.11 AIS Message Tray

The received, sent and saved AIS messages are displayed in AIS Message Tray in a list form.

Memo

The information reference window such as AIS message tray can be switched to standard window display or extended window display.

In this example, extended window display is used.

For the details of switching between standard window display and extended window display, refer to "2.3.2.1 Switching between a standard window and an extended window".

6.11.1 Displaying the AIS message tray

[Operation procedure]

Open the AIS message tray by performing the following menu operations.

[Menu] button → TT/AIS → AIS Message Tray

1 Click on the [AIS MSG Tray] button.

The AIS Message Tray is displayed.

Memo

The AIS message tray can also be displayed by clicking on the [View Tray] button in the [Edit and Send AIS Message] dialogue.

Up to 50 most recent messages are displayed in the message list, from the newest date first. When the 51st message is registered, the message having the oldest date will automatically be deleted.

By clicking any item of the title columns, messages can be sorted in ascending or descending order.

When a message is clicked in the message list, the detailed information of that message will be displayed in the right area of the list.

6.11.2 Switching message display

To display transmitted messages:

Click on the [TX Tray] (Transmitted Tray) button.

To display saved messages:

Click on the [Saved Tray] button.

To display received messages:

Click on the [RX Tray] (Received Tray) button.

Unread messages are displayed in boldface.

To filter messages by specifying the transmission method:

To display only messages sent/received by specifying an MMSI code:

Select [Addressed] from the [Message Format] combo box.

To display only messages distributed through broadcasting:

Select [Broadcast] from the [Message Format] combo box.

When messages are not filtered by the transmission method:

Select [All] from the [Message Format] combo box.

How to select the target by searching with MMSI from the displayed AIS symbol method:

Click on the [Select Symbol] button.

To filter messages by specifying category:

To display only safety related messages:

Select [Safety] from the [Message Category] combo box.

To display only routine messages:

Select [Routine] from the [Message Category] combo box.

When messages are not filtered by category:

Select [All] from the [Message Category] combo box.

If the capacity is exceeded the following rules will be to organize the message.

| Message Type | | Max | Message Organizing Rules. |
|---|----|---|---------------------------|
| Safety Related Address specification | 20 | | |
| Safety Related Broadcast | 20 | (For each AIS type) Delete the oldest message. | |
| Safety Related (Retained) | 20 | (For each AIS type) Delete the oldest message from retained and move It to address or broadcast. If it is exceeded at that time, delete the oldest message. | |
| Routine Message | 50 | (For routine message) Delete the oldest message. | |

6.11.3 Sending a message in the message tray after editing

- 1 Click the message to copy in the message list.
- 2 Click on the [Edit] or [Select] button.

When the AIS message tray is displayed by opening the [AIS Message Tray] submenu:

Click on the [Edit] button.

The [Edit and Send AIS Message] dialogue box appears, and the AIS message will be copied to the [Edit and Send AIS Message] dialogue box. When a message is sent by specifying an MMSI code, the MMSI code will also be copied:

When the AIS Message Tray was displayed by clicking the [View Tray] button in the [Edit and Send AIS Message] dialogue box:

Click the [Select] button.

The AIS message will be copied to the [Edit and Send AIS Message] dialogue box. The MMSI code is not copied by this method.

6.12 Highlighting TT/AIS Symbols

TT/AIS symbols can be highlight them.

[Operation procedure]

Open the highlighting setup screen by performing the following menu operations.

[Menu] button → TT/AIS → Highlighting

6.12.1 Highlighting TT/AIS Symbols by specifying search criteria

TT/AIS symbols can be searched by specifying criteria and highlight them.

- 1 Check [Highlighting by the Following Search Criteria].**
- 2 Check the items you want to make highlighted.**
- 3 Specify search conditions for the checked items.**

[TT/AIS] tab

| Item | Setting |
|-------------------|---|
| Transit Direction | Select a transit direction to be highlighted from the combo box. |
| TCPA (MIN) | Specify the minimum and maximum values in the range between 1 to 99 min. |
| TCPA (MAX) | |
| CPA (MIN) | Specify the minimum and maximum values in the range between 0.1 to 9.9 NM. |
| CPA (MAX) | |
| SOG (MIN) | Specify the minimum and maximum values in the range between 0.0 to 1022.0 kn. |
| SOG (MAX) | |
| Same Fleet (link) | Select a consort ship to be highlighted by linking. For setting the consort ship preset, refer to “13.10 Setting Consort Ship Preset”. |

[AIS] tab

| Item | Setting |
|-------------------|---|
| Length (MIN) | Specify the minimum and maximum values in the range between 1.0 to 1022.0 m. |
| Length (MAX) | |
| Type of Ship | Open the list and click on the type of the ship to be highlighted. For the details of the types of the ships that can be selected, refer to the “List of types of ships”. |
| Cargo Category | Open the list and click on the cargo category to be highlighted. |
| Registry Ship | Specify the MMSI MID Code in the range between 200 and 800. The registry of ship corresponding to the entered code is displayed. |
| Navigation Status | Open the list and select the navigation status to be highlighted. For the details that can be selected, refer to the “Navigation Status” table in “6.6.4 Displaying AIS information”. |

6.12.2 Highlighting AIS Symbols by list

Highlighting by selecting the AIS Target from AIS list displayed ship's name order near in distance from the own ship.

- 1 Check [Highlighting AIS by List].**
- 2 Click on the [List] button.**
The [AIS Highlighting list] dialogue box is displayed.
- 3 Check the radio button you want to make highlighted AIS target.**
The checked AIS target is highlighted.

6.13 Trial Manoeuvring

Memo

- Trial manoeuvring is to simulate own ship's course and speed in the conditions that the course and speed of a target ship are unchanged as they are. The situation is different from any actual ship manoeuvring, so set values with large margins to CPA Limit and TCPA Limit.
- During trial, the CPA/TCPA (TT) alarm cannot be approved. To approve the alarm, terminate the trial.

6.13.1 Outline of trial manoeuvring

The trial manoeuvring is the function of simulating own ship's course and speed for collision avoidance when a dangerous target appears. When the own ship's course and speed are entered in manual mode, the trial manoeuvring function checks if pre-acquired or pre-activated targets are dangerous.

Trial manoeuvring in the true vector mode

If the own ship's vector mode is the true vector mode, the own ship's vector is calculated according to the own ship's trial speed and trial course as well as the own ship's dynamic characteristic, and the result is displayed as the own ship's expected course. The following figures show an example of veering to the left: the dangerous target at front right has changed to a safe target as a result of trial manoeuvre.

The tracked target information indicates the current CPA and TCPA values regardless of the result of simulation.

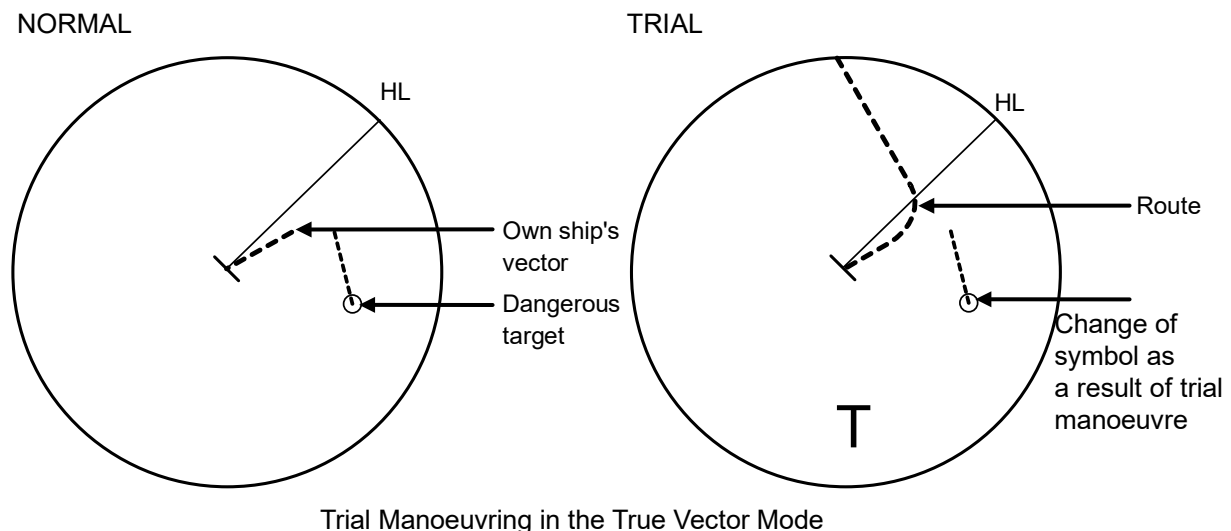

Trial manoeuvring in the relative vector mode

If the own ship's vector mode is the relative vector mode, an expected relative course of the target is displayed in relation to the own ship's expected course when in the true vector mode. The following figures show an example of a dangerous target changing to a safe target. The target vector will cross the CPA ring and will thus be a dangerous target. By trial manoeuvre of ship avoidance simulation (under the same condition as the true vector in the previous section), the relative vector (expected course) of the target changes to a safe target as shown in the lower figure.

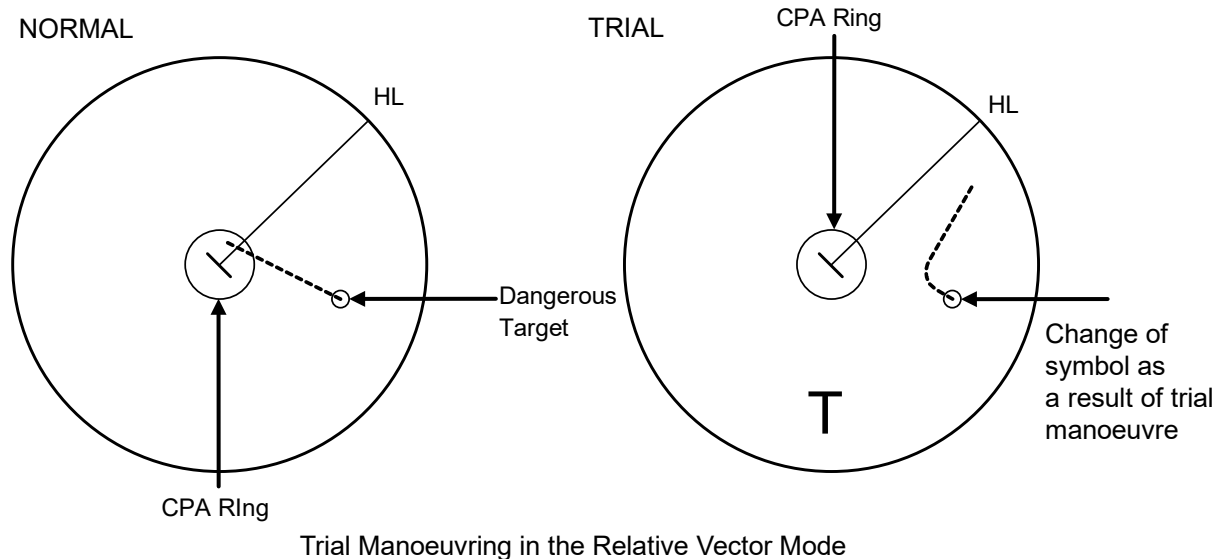

The above figure shows that the relative vector of the target has changed as shown in the Figure as a result of simulation (course and speed) in the previous section, so that the symbol colour is changed into "White", a safe target.

Irrespective of the simulation results, the current CPA and TCPA values are shown in the tracked target information just like when the true vector mode is active.

The course change of own ship is displayed as a dotted-line.

Better information is provided by using the trial relative vector mode when sea stabilisation mode is active.

6.13.2 Performing a trial manoeuvre

[Operation procedure]

Open the Trial (Trial Manoeuvre) screen by performing the following menu operations.

[Menu] button → TT/AIS → Trial Manoeuvre

1 Select the [Trial Function] checkbox.

The trial function is turned on.

When Trial Function is set to On, the character "T" blinks at the bottom of the own ship display field in the radar display and means a trial manoeuvre.

2 Click on the [Course] and [Speed] boxes and enter setting values.

Memo

[Course] can be set up by turning the [EBL] dial and [Speed] by turning the [VRM] dial.

3 Set other characteristics.

[Vector Time]: Vector time (1 to 120 min)

[Time to Manoeuvre]: Time until trial manoeuvring is started (0 to 30 min)

[Own Ship's Dynamic Trait]:

A dialogue for setting a dynamic trait of own ship is displayed.

For the setting of [Own Ship's Dynamic Trait], refer to "13.9 Setting Own Ship's Dynamic Trait".

The dangerous target symbol is displayed in red and the safe target symbol is displayed in white.

The safe target symbol colour can be changed by using [Target Symbol] that is displayed by selecting [Settings] - [Colour and Brightness]. For the details, refer to "13.22 Setting Colours and Brightness".

Vector Time is valid only when Trial Function is set to On. If it is Off, the vector time before trial manoeuvring is displayed.

Time until the start of trial manoeuvring is counted down directly after the input.

The acceleration and deceleration are influenced depending on the relationship between the current speed and the input speed for trial manoeuvring.

If 0.0 kn/min is set for [Acceleration] when the speed for trial manoeuvring is faster than the current speed, or for [Deceleration] when the speed for trial manoeuvring is slower than the current speed, the system performs simulation on the assumption that the speed is changed directly after the time set for [Time to Manoeuvre].

To finish trial operation:

1 Clear the [Trial Function] checkbox.

6.14 Displaying the TT/AIS Target List

The information of targets being monitored with the TT and AIS functions can be displayed in a list on the information monitoring window.

[Operation procedure]

Open the TT/AIS list by performing the following menu operations.

[Menu] button → TT/AIS → TT/AIS List

6.14.1 TT list

Take the following steps to display the TT list and AIS list.

When the [TT List] button is clicked on, TT information is displayed.

For the TT list, a standard window and an extended window can be switched alternately.

To switch to an extended window, click on the List extension button.

To switch to a standard window, click on the List Standard button.



The following items are displayed in the TT list.

| Item | Description |
|------------|---|
| ID | ID No. of tracked target |
| CPA | Closest approach distance |
| TCPA | Time up to closest approach distance |
| BCR | Bow crossing distance |
| BCT | Bow crossing time |
| COG or CTW | COG: Course Over the Ground or CTW: Course Through the Water bearing *In ground mode, COG is displayed. In water mode, CTW is displayed. |
| SOG or STW | SOG: Speed Over the Ground or STW: Speed Through the Water *In ground mode, SOG is displayed. In water mode, STW is displayed. |
| BRG | True bearing from target own ship *Displayed when [BRG/RNG] is selected. |
| RNG | Range from target own ship *Displayed when [BRG/RNG] is selected. |
| LAT | Target latitude *Displayed when [LAT/LON] is selected. *Not displayed on the standard window. |
| LON | Target longitude *Displayed when [LAT/LON] is selected. *Not displayed on the standard window. |
| Status | Status Acquiring / Tracking / Lost *Not displayed on the standard window. |

6.14.2 AIS list

When the [AIS List] button is clicked on, AIS information is displayed.

For the AIS list, a standard window and an extended window can be switched alternately.

To switch to an extended window: Click on the List extension button.

To switch to a standard window: Click on the List standard button.



The following items are displayed in the AIS list.

| Item | Description |
|------------|--|
| ID | ID No. of AIS |
| CPA | Closest approach distance |
| TCPA | Time up to closest approach distance |
| COG or CTW | COG: Course Over the Ground or CTW: Course Through the Water bearing *In ground mode, COG is displayed. In water mode, CTW is displayed. *Displayed when [COG/SOG/Name/Call Sign/MMSI/Source] is selected. |
| SOG or STW | SOG: Speed Over the Ground or STW: Speed Through the Water *In ground mode, SOG is displayed. In water mode, STW is displayed. *Displayed when [COG/SOG/Name/Call Sign/MMSI/Source] is selected. |
| Name | Ship name *Displayed when [COG/SOG/Name/Call Sign/MMSI/Source] is selected. |
| Call Sign | Call sign *Displayed when [COG/SOG/Name/Call Sign/MMSI/Source] is selected. |
| MMSI | Maritime Mobile Service Identity *Displayed when [COG/SOG/Name/Call Sign/MMSI/Source] is selected. |
| Source | AIS information source - Direct - Repeated - VTS *Displayed when [COG/SOG/Name/Call Sign/MMSI/Source] is selected. *Not displayed on the standard window. |
| BCR | Bow crossing distance *Displayed when [BCR/BCT/BRG/RNG/HDG/POSN/Status] is selected. *Not displayed on the standard window. |
| BCT | Bow crossing time *Displayed when [BCR/BCT/BRG/RNG/HDG/POSN/Status] is selected. *Not displayed on the standard window. |
| BRG | True direction *Displayed when [BCR/BCT/BRG/RNG/HDG/POSN/Status] is selected. *Not displayed on the standard window. |
| RNG | Distance *Displayed when [BCR/BCT/BRG/RNG/HDG/POSN/Status] is selected. *Not displayed on the standard window. |

| Item | Description |
|--------------------------|--|
| HDG | Heading *Displayed when [BCR/BCT/BRG/RNG/HDG/POSN/Status] is selected. *Not displayed on the standard window. |
| Lat | Latitude *Displayed when [BCR/BCT/BRG/RNG/HDG/POSN/Status] is selected. *Not displayed on the standard window. |
| Lon | Longitude *Displayed when [BCR/BCT/BRG/RNG/HDG/POSN/Status] is selected. *Not displayed on the standard window. |
| Status | Status Sleeping: Sleeping in progress Activated: Activation in progress Lost: Lost status Danger: Dangerous ship (only transmitting state) *Displayed when [BCR/BCT/BRG/RNG/HDG/POSN/Status] is selected. *Not displayed on the standard window. |
| [Show AIS Detail] button | When one item is selected from the list and this button is clicked, AIS detail information is displayed in the information monitoring window. For the details, refer to "2.3.1.4 AIS Detail INFO". |

6.15 Confirming Own Ship's AIS Information

[Operation procedure]

Open the own ship's AIS information screen by performing the following menu operations.

[Menu] button → TT/AIS → Own Ship AIS Data

When the [Own Ship AIS Data] button is clicked on, AIS information of own ship is displayed.

For the own ship's AIS information screen, a standard window and an extended window can be switched alternately.

To switch to an extended window: Click on the List extension button.

To switch to a standard window: Click on the List standard button.

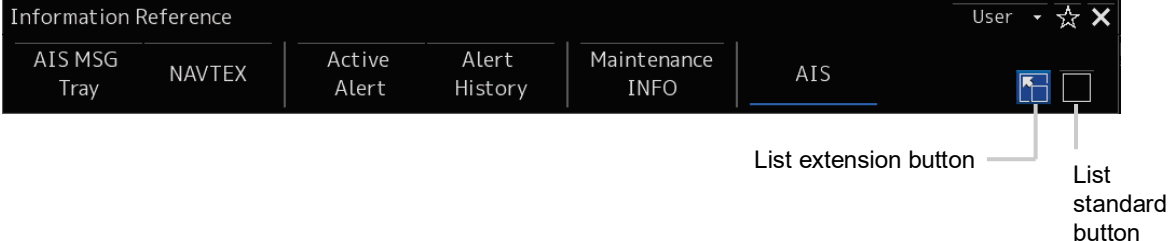

6.16 Displaying the Last Lost AIS Target

[Operation procedure]

Open the last lost AIS target information screen by performing the following menu operations.

[Menu] button → TT/AIS → Last Lost AIS Data

When the [Last Lost AIS Data] button is clicked on, the last lost AIS information is displayed.

For the last lost AIS target information screen, a standard window and an extended window can be switched alternately.

To switch to an extended window: Click on the List extension button.

To switch to a standard window: Click on the List standard button.



Section 7 True and False Echoes on Display

The radar operator has a role of interpreting the radar displays to provide his best aid in manoeuvring the ship.

For this purpose, the operator has to observe the radar displays after fully understanding the advantages and disadvantages that the radar has.

For better interpretation of radar display, it is important to gain more experiences by operating the radar equipment in fair weathers and comparing the target ships watched with the naked eyes and their echoes on the radar display.

The radar is mainly used to monitor the courses of own ship and other ships in open seas, to check buoys and other nautical marks when entering a port, to measure own ship's position in the coastal waters relative to the bearings and ranges of the shore or islands using a chart, and to monitor the position and movement of a heavy rain if it appears on the radar display.

Various types of radar display are explained below.

7.1 Radar Wave with the Horizon

Radar beam radiation has the nature of propagating nearly along the curved surface of the earth. The propagation varies with the property of the air layer through which the radar beam propagates. In the normal propagation, the distance (D) of the radar wave to the horizon is approximately 10% longer than the distance to the optical horizon. The distance (D) is given by the following formula:

$$D = 2.23(\sqrt{h_1} + \sqrt{h_2}) \text{ (NM)}$$

h_1 : Height (m) of radar antenna above sea level

h_2 : Height (m) of a target above sea level

The following figure illustrates a diagram for determining the maximum detection range of a target that is limited by the curve of the earth surface in the normal propagation.

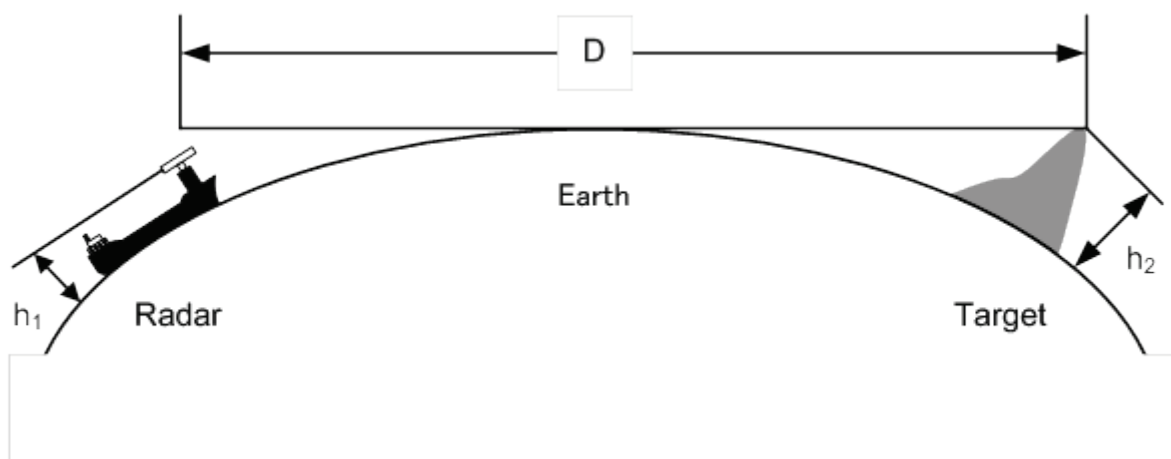

Radar Wave with the Horizon

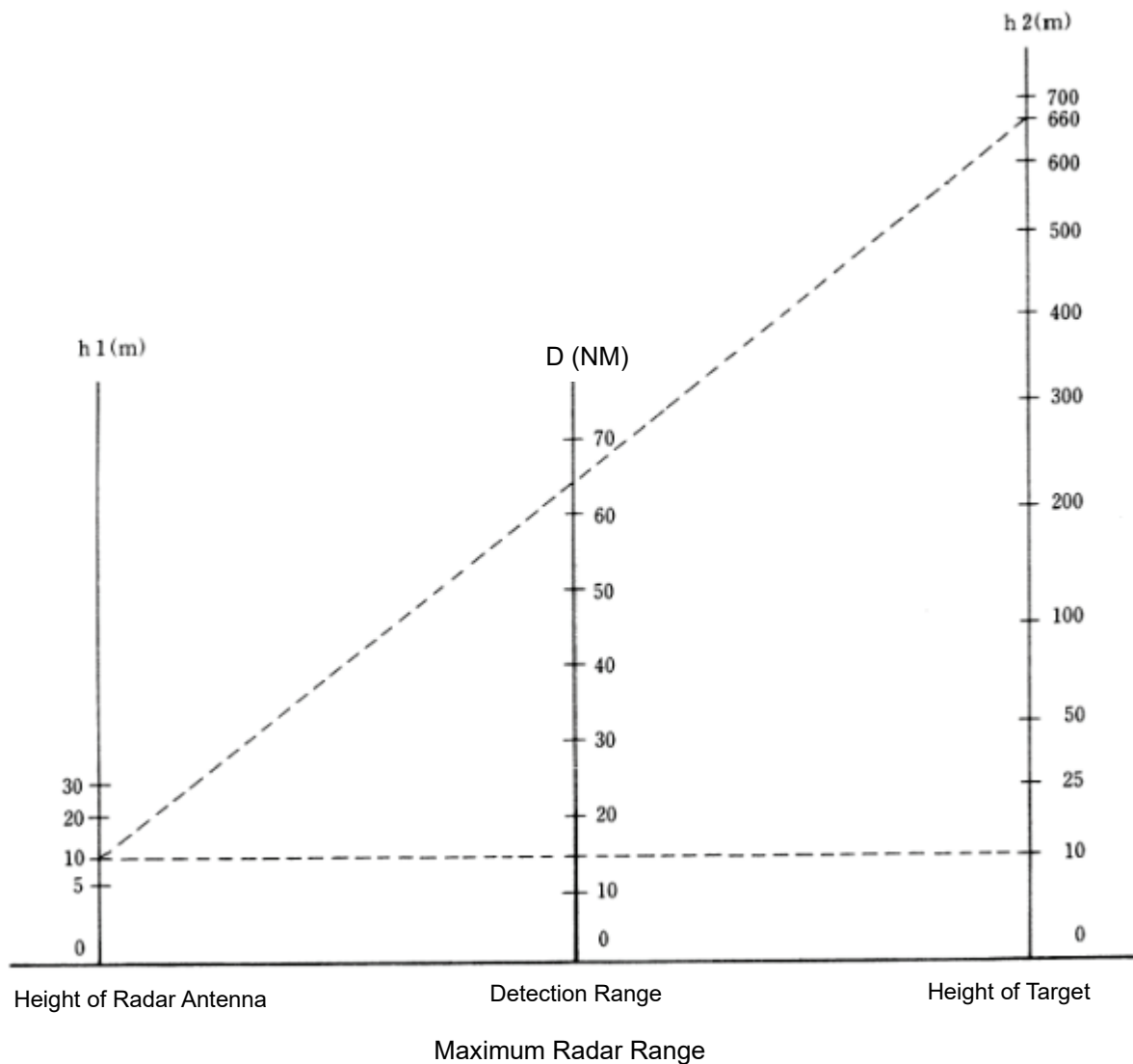

When the height of own ship's radar antenna is 10 m for instance,

- (1) A target that can be detected at the radar range of 64 NM on the radar display is required to have a height of 660 m or more.
- (2) If the height of a target is 10 m, the radar range has to be approx. 15 NM.

However, the maximum radar range at which a target can be detected on the radar display depends upon the size of the target and the weather conditions, that is, the radar range may increase or decrease depending upon those conditions.

7.2 Intensity Reflected from the Target

The signal intensity reflected from a target depends not only on the height and size of the target but also on its material and shape. The echo intensity from a higher and larger target is not always higher in general. In particular, the echo from a coast line is affected by the geographic conditions of the coast. If the coast has a very gentle slope, the echo from a mountain of the inland like the figure below appears on the radar display. Therefore, the distance to the coast line should be measured carefully.

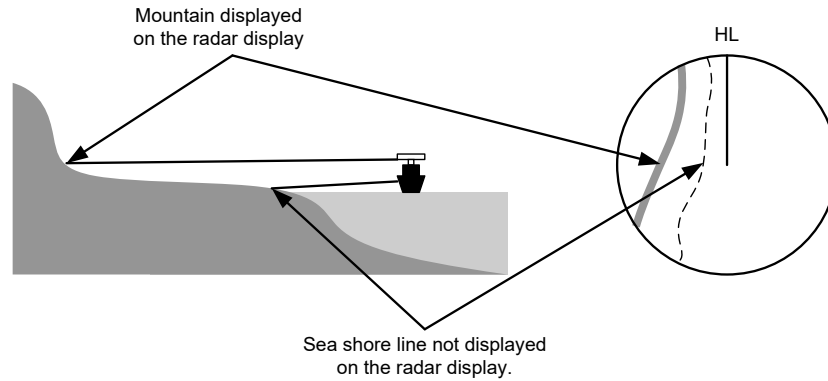

Sea Shore Line Not Displayed on the Radar Display

The next table shows the relation between the target detection range and the radar reflection cross-sectional area (RCS) with regard to the type and the height of the target in a situation in which the weather is good, the sea state is calm and the radio wave propagation is normal. As revealed by this table, even on the same sea shore line, detection range greatly differs depending on the height of the target from the surface of the sea. Furthermore, because the target detection range is greatly influenced by the shape and material of the target and environmental conditions, such as the sea state, weather, and radio wave propagation, caution should be taken when detecting range of target.

Relation between Type and Height of Target and Detection Range and RCS

| Type of target | Height from sea surface (m) | Detection range (NM) | | RCS (m ²) | |
|---|-----------------------------|----------------------|--------|-----------------------|--------|
| | | X band | S band | X band | S band |
| Sea shore line | 60 | 20 | 20 | 50,000 | 50,000 |
| Sea shore line | 6 | 8 | 8 | 5,000 | 5,000 |
| Sea shore line | 3 | 6 | 6 | 2,500 | 2,500 |
| SOLAS target ship (>5000GT) | 10 | 11 | 11 | 50,000 | 30,000 |
| SOLAS target ship (>500GT) | 5 | 8 | 8 | 1,800 | 1,000 |
| Small boat with IMO standard compatible radar reflector | 4 | 5.0 | 3.7 | 7.5 | 0.5 |
| Marine buoy with corner reflector | 3.5 | 4.9 | 3.6 | 10 | 1 |
| Standard marine buoy | 3.5 | 4.6 | 3.0 | 5 | 0.5 |
| 10-metre small boat without radar reflector | 2 | 3.4 | 3.0 | 2.5 | 1.4 |
| Waterway location beacon | 1 | 2.0 | 1.0 | 1 | 0.1 |

Memo

Detection range shown in the above table may greatly decrease depending on the shape of the target, sea state, weather and radio wave propagation conditions.

7.3 Sea Clutter and Rain/Snow Clutter

In addition to the echoes required for observing ships and land, radar video images that are displayed also include undesirable echo images, such as reflection from waves on the sea surface and reflection from rain and snow. Reflection from the sea surface is called sea clutter and reflection from rain, snow, and cloud is called rain and snow clutter. Those interfering waves must be eliminated by the clutter rejection function ([Settings] – [Signal Process] – [Video Noise Rejection]). (Refer to “13.2 Setting Radar Signal Processing”.)

7.3.1 Sea clutter

Sea clutter appears as an image radiating outwardly from the centre of the radar display and changing depending on the size and the shape of waves. Generally, as waves become larger, image level of the sea clutter is intensified and the clutter far away is also displayed. In this case, it is difficult to distinguish sea clutter from a small boat whose reflection intensity is weak. Accordingly, it is necessary to properly adjust the sea clutter rejection function.

The following tables show the relation between the sea state (SS) showing the size of waves generated by wind and the radar's detection probability.

Sea State and Probability of Target Detection

| RCS | SS1 to 2 | SS2 to 3 | SS3 to 4 | SS4 to 5 |
|--------------------|----------|----------|----------|----------|
| 0.1 m ² | V | V-M | M-NV | |
| 0.5 m ² | V | V | V-M | M-NV |
| 1 m ² | V | V | V | V-M |

S band radar (probability to detect a target at a range of 0.4 NM)

| RCS | SS1 to 2 | SS2 to 3 | SS3 to 4 | SS4 to 5 |
|-------------------|----------|----------|----------|----------|
| 1m ² | V-M | M-NV | | |
| 5 m ² | V | V-M | M-NV | |
| 10 m ² | V | V | V | V-M |

X band radar (probability to detect a target at a range of 0.7 NM)

V: Detection probability of 80 %

M: Detection probability of 50 %

NV: Detection probability of less than 50 %

As shown in the following table, the number of SS increases as the wind speed becomes high and the waves become large. The tables in the previous page show that detection probability decreases from V (80 %) to NV (less than 50 %) as the number of SS increases. Therefore, even if the sea state is calm and a target clearly appears on the radar display, when the sea state becomes rough, target detection probability decreases resulting in difficulty of target detection by the radar.

Relation between Douglas Sea State and Average Wind Speed and Significant Wave Height

| Sea state | Average wind speed (kn) | Significant wave height (m) |
|-----------|-------------------------|-----------------------------|
| 0 | <4 | <0.2 |
| 1 | 5-7 | 0.6 |
| 2 | 7-11 | 0.9 |
| 3 | 12-16 | 1.2 |
| 4 | 17-19 | 2.0 |
| 5 | 20-25 | 3.0 |
| 6 | 26-33 | 4.0 |

Significant wave height: an average of top N/3 higher waves when the number of waves detected within a constant time duration is N

For example, in the case of a standard marine buoy, RCS of X band radar is 5 m² as shown in the Table “Relation between Type and Height of Target and Detection Range and RCS” on Page 7-4. When observing such a target in the sea state (SS3) in which significant wave height exceeds 1.2 metres, detection probability is M-NV, as shown in the Table on page 7-5, which indicates 50 % or less.

7.3.2 Rain and snow clutter

Rain and snow clutter is a video image that appears in a location where rain or snow is falling. The image changes according to the amount of rain (or the amount of snowfall). As precipitation increases, the image of rain and snow clutter becomes intensified on the radar display, and in the case of localized heavy rain, an image similar to the image indicating land is displayed in some cases. Furthermore, because radio waves tend to attenuate due to rain and snow, the ability to detect a target in the rain and snow clutter or a target beyond the rain and snow clutter may decrease. The amount of attenuation depends on the transmission frequency, antenna beam width, and the pulse length. The following 2 graphs show examples in which detection range is reduced due to the influence of precipitation. Because of this, a target, which clearly appeared up to 10 NM by an X band radar (pulse length of 0.8 μs) when it was not raining, may become dimly visible up to 5 NM when the amount of rain becomes 4 mm/hr. Furthermore, when comparing the X band radar with the S band radar, target detection range decreases less when an S band radar is used, which means it is influenced less by precipitation.

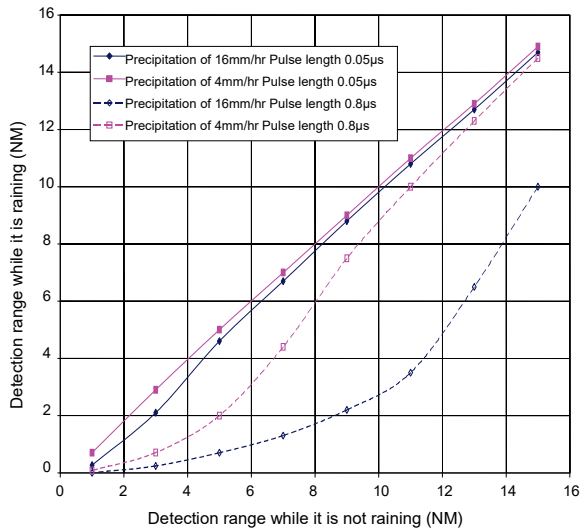

Decreased Target Detection Range by S Band Radar due to Precipitation

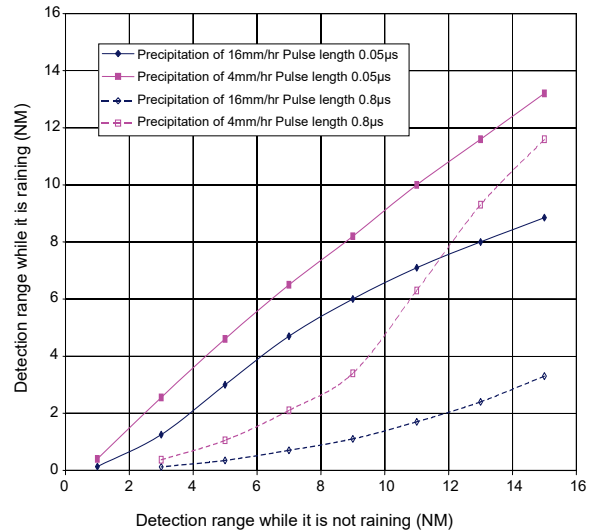

Decreased Target Detection Range by X Band Radar due to Precipitation

Memo

Under rain, the targets that enter within sea clutter may be more difficult to detect.

7.3.3 Coping with sea clutter and rain/snow clutter

Under the conditions of rough ocean due to bad weather, the use of S band radar is effective because of its comparatively low influence from sea clutter and low attenuation against raindrops. When an X band radar is used, the use of short pulse is effective by reducing the applied pulse width since a reduction of the pulse width reduces the influence of interfering waves and also increases the effect of interfering wave rejection function. The effect of interfering wave control can be enhanced further by setting various items of Radar signal information.

By using the observation scene selection function, the optimum setting values can also be retrieved according to various conditions such as weather (the setting value for Storm or Rain is recommended for stormy weather).

For the description of the observation scene button, refer to "5.3.7 Adjusting to optimal images (Selection of observation scenes)". While these settings are effective, targets, particularly, those that move at high speed may not be recognised visually.

7.4 False Echoes

The radar observer may be embarrassed with some echoes that do not exist actually. These false echoes appear by the following causes that are well known:

7.4.1 Shadow

When the radar antenna is installed near a funnel or mast, the echo of a target that exists in the direction of the funnel or mast cannot appear on the radar display because the radar beam is reflected on the funnel or mast. Whether there are some false echoes due to shadows can be checked monitoring the sea clutter, in which there may be a part of weak or no returns. Such shadows appear always in the same directions, which the operator should have in mind in radar operation.

7.4.2 Side lobe effect

A broken-line circular arc may appear at the same range as the main lobe of the radar beam on the radar display. This type of false echo can easily be discriminated when a target echo appears isolated.

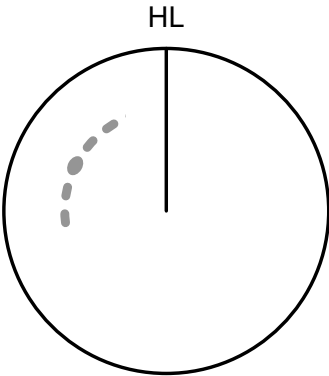

False Echoes

When a radar antenna for the solid-state radar is connected, a false echo may occur in the range direction of the target image. This false echo normally means a range side lobe, which is generated as a result of pulse compression processing when a large target such as a vessel is at a short distance.

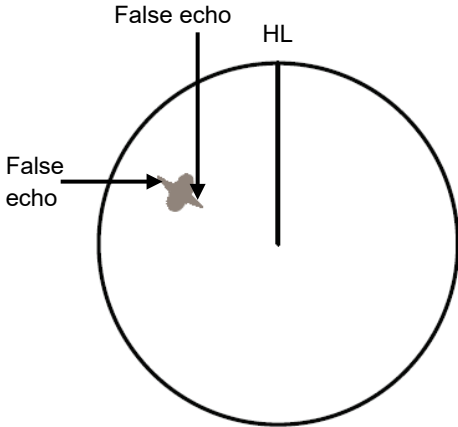

Range Side Lobe

7.4.3 False echo by secondary reflection

When a target exists near own ship, two echoes from the single target may appear on the radar display.

One of those echoes is the direct echo from the target and the other is the secondary reflection from a mast or funnel that stands in the same direction as shown in the following Figure.

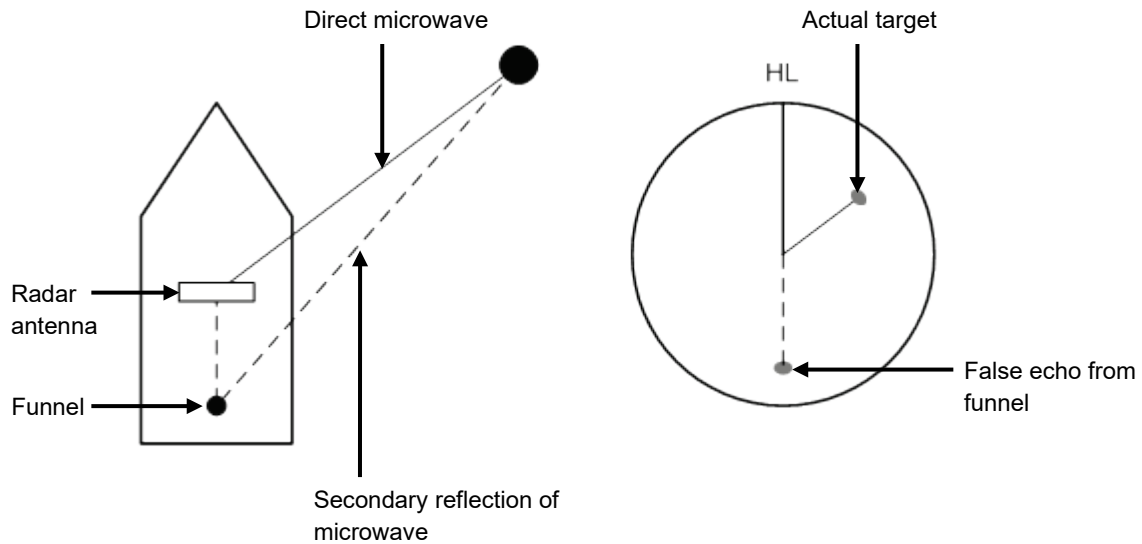

Example of false echo by secondary reflection

7.4.4 False echo by multiple reflection

When there is a large structure or ship with a high vertical surface near own ship as shown in the following Figure, multiple reflection may appear on the radar display. These echoes appear in the same intervals, of which the nearest echo is the true echo of the target.

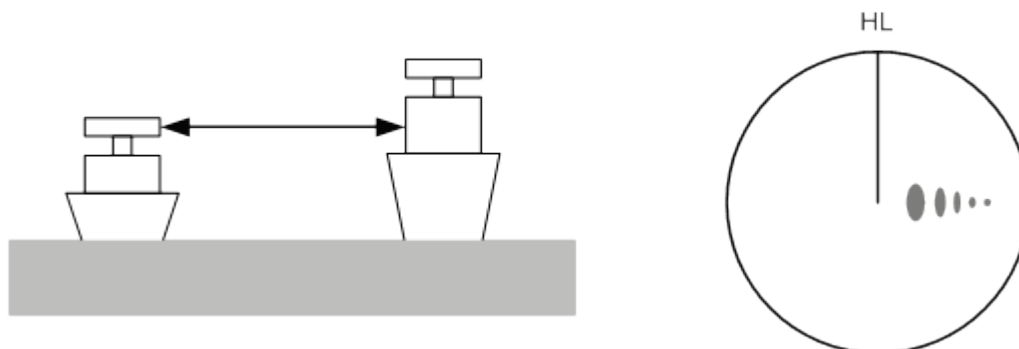

False Eco by Multiple Reflection

7.4.5 Second time echoes

The maximum radar detection range depends upon the height of the radar antenna and the height of a target as described in the section "7.1 Radar Wave with the Horizon". If a so-called "duct" occurs on the sea surface due to a certain weather condition, however, the radar beam may propagate to an abnormally long distance, at which a target may be detected by the radar.

For instance, assuming that the transmitter pulse length is MP3 (on the repetition frequency of 1400 Hz), the primary pulse is reflected about 58 NM or more away from a target and received during the next pulse repetition time. In this case, a target image appears as a false echo (second time echo) at a position that is about 58 NM less than the actual range on the radar screen.

If the false echo appears at 5 NM on the radar display, the true range of the target is $5 + 58 = 63$ NM.

On the transmitter pulse length is SP1 (on the repetition frequency of 2250 Hz), a false echo may appear at a position that is about 36 NM less than the actual range.

This type of false echo can be discriminated by checking the change of the target range by switching the transmitted pulse length (the repetition frequency).

False echoes can be suppressed by specifying [Economy] after selecting [Setting] – [TXRX] – [PRF] or by setting [Stagger Trigger] to On after selecting [Settings] – [TXRX] - [Stagger Trigger]. (For the details, refer to "13.7 Setting Radar Antennas".)

7.4.6 Radar interference

When another radar equipment using the same frequency band is near own ship, a radar interference pattern may appear on the radar display. This interference pattern consists of a number of spots which appear in various forms. In many cases, these spots do not always appear at the same places, so that they can be discriminated from the target echoes.

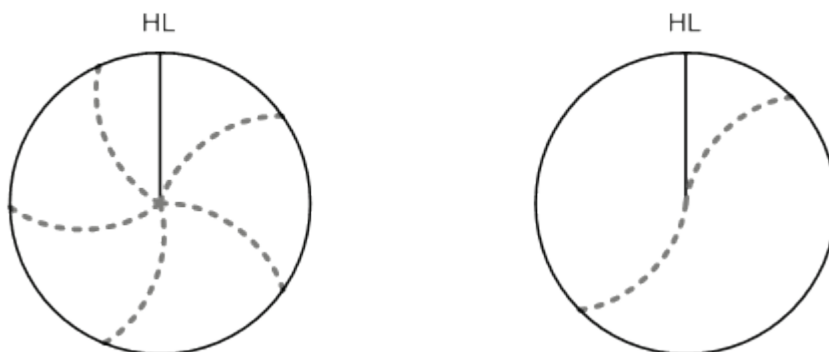

If radar equipment causing an interference pattern and this equipment are of the same model, their transmitting repetition frequency is nearly the same. As a result, interference patterns may be displayed concentrically.

In this case, since the interference patterns cannot be rejected by using only the interference rejection function, fine-tune the transmitting repetition frequency. (Refer to "13.7 Setting Radar Antennas")

By applying different transmitting repetition frequencies, the interference rejection effect can be improved.

7.5 Radar Transponder (SART) Screen Display

SART is life-saving equipment that was approved by GMDSS and is used for detecting positions of survivors who suffer from distress accidents. SART, which operates under the frequency band of 9GHz, receives a radar wave of 9GHz that is launched from the radar of the rescue boat or plane and generates a series of response signals to notify the accident position to the searchers.

Set the equipment to the following in order to receive SART signals. Use the settings for SART reception for detecting beacons and target enhancers also.

- 1 Set the range scale to [6NM] or [12NM] by using the Range Scale button on the RADAR screen.**
- 2 Set the settings of [Settings] – [Signal Process] – [SART] to On (check the check box for SART).**

Memo

The SART setting check boxes are not displayed at connection of a solid-state radar antenna.

The SART display mode is set to On. In this case, the items on the [Settings] menu are changed automatically as shown in the table below.

For the settings of SART, refer to “13.2 Setting Radar Signal Processing”

| Setting item | Setting value |
|----------------------------------|--|
| Sea (Sea clutter control) | In [MAN] (manual), the value is changed to 0 (minimum value) and in [AUTO] (automatic), the mode is changed to [MAN] and the value to 0 (minimum value). |
| Rain (rain/snow clutter control) | |
| Manual Tune (Tuning) | Off (Set tuning to Off to weaken clutter display) |
| IR (Interference removal) | Off |
| Echo Process (Image processing) | Process Off |

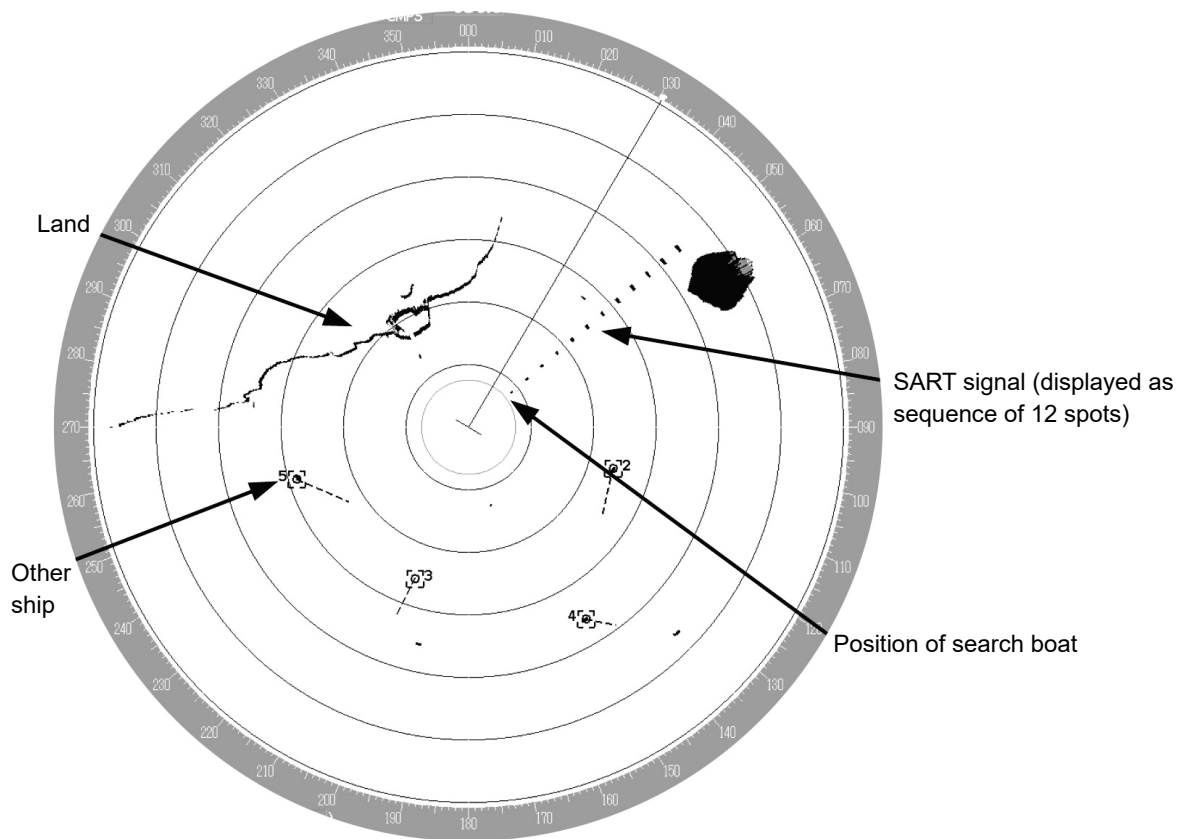

Memo

- When the SART display mode is set to On to detect SART signals, small targets around own ship may no longer be displayed on the radar. Therefore, implement sufficient visual monitoring at the periphery of own ship to prevent collision and grounding. When multiple radars are installed, use one 9-GHz band radar for detection of SART signals and use others as normal radars for collision prevention, monitoring of targets at the periphery of own ship, prevention of grounding, and checking of own ship's position.
- After termination of SART signal detection, set the SART display to Off (uncheck the check box for SART after selecting [Settings] – [Signal Process] – [SART]). The radar is reset to the normal navigation mode.

7.6 Display of AIS-SART

AIS-SART is a device to display data relating to the position of the ship in distress on the AIS display unit of the ship station and coast radio station which install the AIS.

This device can be applied instead of Radar Transponder (SART).

When connecting this device with the AIS, AIS-SART symbols can be also displayed on the radar screen.

7.6.1 Radar screen display example

If receiving AIS-SART signals from its device, an AIS-SART symbol is displayed on the radar screen.

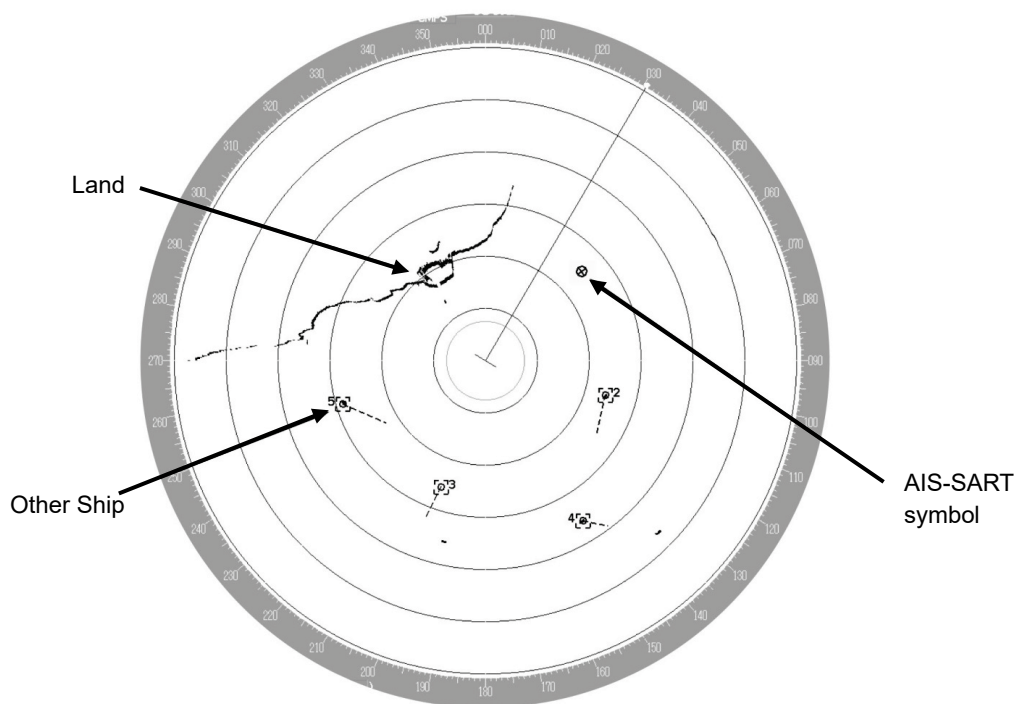

Example of AIS-SART Symbol Display

*For the details of AIS-SART symbols, refer to "6.3.3 Types and Definitions of AIS Target Symbols".

7.6.2 Numeric data display example

If the symbol is clicked on while the AIS-SART symbol is displayed, AIS-SART numeric information is displayed on [Target Information] on the information monitoring window.

Navigation information is displayed according to the operating status as shown below.

- Normal operation: AIS-SART ACTIVE (14)
- Trial operation: AIS-SART TEST (15)

If displaying "AIS-SART TEST (15)", it indicates that the AIS-SART operation test is performing.

Section 8 Monitoring a Dragging Anchor

Anchor Watch is a function that sets a circular or polygonal dragging anchor monitoring area around the own ship and realizes safe voyage by generating an anchor alarm when a part of the outline of the own ship exceeded the monitoring area.

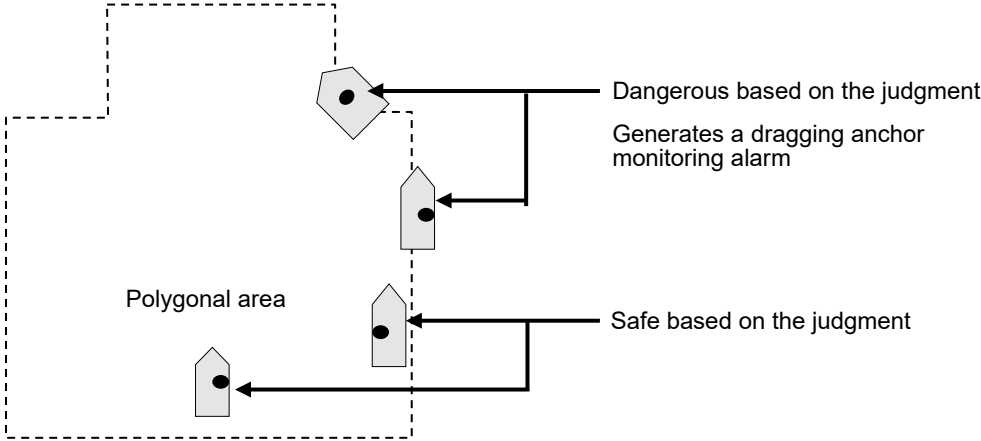
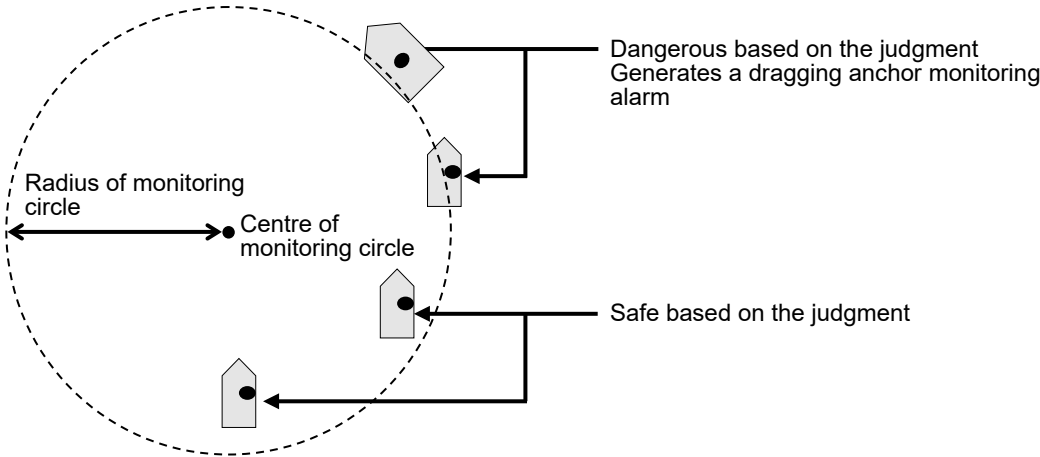

Dragging Anchor Monitoring Area

8.1 Setting a Dragging Anchor Monitoring Area

This section describes the setting of a dragging anchor monitoring area.

The setting varies depending on whether the shape of the dragging anchor area is a circle or a polygon.

[Operation procedure]

Open the Dragging Anchor Monitoring screen by performing the following menu operations.

[Menu] button → Anchor Watch

8.1.1 Setting a dragging anchor monitoring circle

- 1 Select [Circle] from the [Mode] (dragging anchor monitoring mode) combo box.
- 2 Enter the centre position and size of the dragging anchor monitoring area.
[Position]: Input latitude in the input box.
Input longitude in the input box.
[Radius]: Input a radius of the circle in the input box.
Input range: 10 to 1500 m

8.1.2 Setting a dragging anchor monitoring polygon

- 1 Select [Polygon] from the [Mode] (dragging anchor monitoring mode) combo box.
- 2 Click on the [New] button.
The data of the [Point] (vertex) list is cleared.
- 3 Place the cursor on the chart.
- 4 Create a polygon by dragging the cursor on the chart.

By inputting position coordinates (longitude and latitude) of the vertex position of the polygon in the [Point] list, the vertex position can be changed.

When a polygon is created, the number of vertices is displayed in [(Total:)]. Up to 360 vertices can be set.

Creation example:

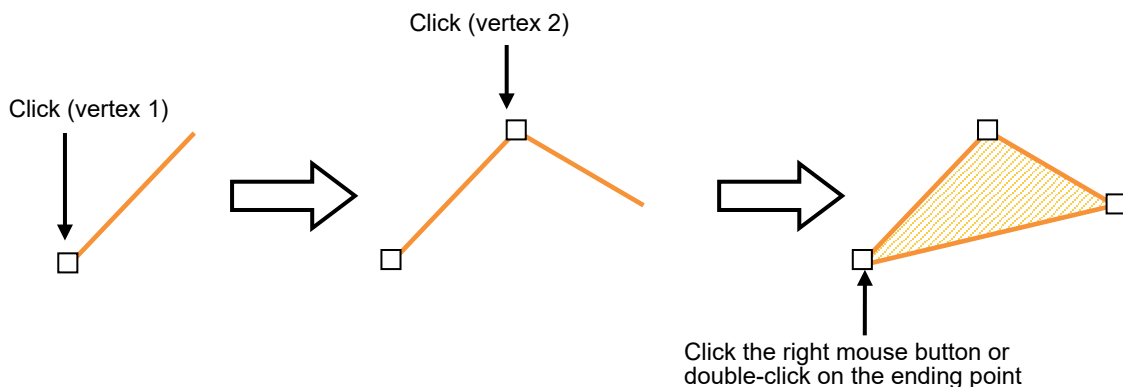

8.2 Starting and Ending Dragging Anchor Monitoring

8.2.1 Starting dragging anchor monitoring

[Operation procedure]

Open the dragging anchor monitoring screen by performing the following menu operations.

[Menu] button → Anchor Watch

- 1 When the dragging anchor monitoring screen is opened, the preview of the dragging anchor monitoring area that was set on the chart is displayed (broken line).**

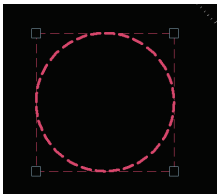

When the dialogue is displayed, the own ship's position is placed at the centre of the circle.

- 2 Set the dragging anchor monitoring to [On] by clicking on the [Monitoring Anchor] button.**

Dragging anchor monitoring starts based on the setting.

The dragging anchor monitoring area on the chart is changed to a solid line.

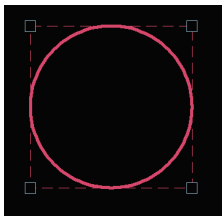

When own ship exits from the dragging anchor monitoring area, the "Dragging anchor" warning is displayed.

8.2.2 Ending dragging anchor monitoring

Set the button display to [Off] by clicking on the [Monitoring Anchor] button.

Alternatively, use the following procedure.

- 1 Click the right mouse button on the dragging anchor monitoring circle.**

A context menu is displayed.

- 2 Click on [Finish Anchor Watch] on the context menu.**

The [Monitoring Anchor] button display is set to [Off] and the dragging anchor monitoring area on the chart changes to broken line display.

8.3 Moving/Editing/Deleting a Dragging Anchor Monitoring Area on the Chart

A dragging anchor monitoring area can be moved to any position or the size or shape can be changed or deleted on the chart.

These operations are also available on the context menu.

These operations can be performed either before or after starting dragging anchor monitoring.

8.3.1 Moving a dragging anchor monitoring circle on the chart

- 1 Click on the dragging anchor monitoring circle.**
A square enclosing the dragging anchor monitoring circle is displayed.
- 2 Click on the dragging anchor monitoring circle.**
The cursor is set to the Edit cursor.
- 3 Move the cursor to any position and click the mouse button.**
The dragging anchor monitoring circle is moved.

8.3.2 Moving a dragging anchor monitoring circle on the context menu

The moving of a dragging anchor monitoring circle can also be executed from the context menu.

- 1 Click on the dragging anchor monitoring circle.**
A square enclosing the dragging anchor monitoring circle is displayed.
- 2 Click the right mouse button on the dragging anchor monitoring circle.**
The context menu is displayed.
- 3 Click on [Move this object] on the context menu.**
The cursor is set to the Edit cursor.
- 4 Move the cursor to any position and click the mouse button.**
The dragging anchor monitoring circle is moved.

8.3.3 Moving a dragging anchor monitoring polygon on the chart

- 1 Click the mouse button inside of the dragging anchor monitoring polygon.**
The [Anchor Watch] dialogue is displayed.
- 2 Click the mouse button inside of the dragging anchor monitoring polygon.**
The cursor is set to the Edit cursor.
- 3 Move the cursor to any position and click the mouse button.**
The dragging anchor monitoring polygon is moved.

8.3.4 Moving a dragging anchor monitoring polygon on the context menu

The moving of a dragging anchor monitoring polygon can also be executed from the context menu.

- 1 Click the right mouse button on a line of the dragging anchor monitoring polygon.**
A context menu is displayed.
- 2 Click on [Move this object] on the context menu.**
The cursor is set to the Edit cursor.
- 3 Move the cursor to any position and click the mouse button.**
The dragging anchor monitoring polygon is moved.

8.3.5 Changing a size of a dragging anchor monitoring circle on the chart

- 1 Click on the dragging anchor monitoring circle.**
A square enclosing the dragging anchor monitoring circle is displayed.
- 2 Click on any of the vertices of the square enclosing the dragging anchor monitoring circle.**
The cursor changes to the arrow cursor.
- 3 Move the cursor until the dragging anchor monitoring circle becomes a required size and click the mouse button.**
The size of the dragging anchor monitoring circle is changed.

8.3.6 Changing a size of a dragging anchor monitoring circle on the context menu

Change of a dragging anchor monitoring circle can also be executed from the context menu.

- 1 Click on the dragging anchor monitoring circle.**
A square enclosing the dragging anchor monitoring circle is displayed.
- 2 Click the right mouse button on any of the vertexes of the square enclosing the dragging anchor monitoring circle.**
A context menu is displayed.
- 3 Click on [Change Radius] on the context menu.**
The cursor is set to the Arrow cursor.
- 4 Move the cursor until the dragging anchor monitoring circle becomes a required size and click the mouse button.**
The size of the dragging anchor monitoring circle is changed.

8.3.7 Changing a shape of a dragging anchor monitoring polygon on the chart

Changing a vertex

- 1 Click the mouse button inside of the dragging anchor monitoring polygon.**
The [Anchor Watch] dialogue is displayed.
- 2 Click on the vertex of the dragging anchor monitoring polygon to be changed.**
The cursor is set to the Edit cursor.
- 3 Move the cursor to the required vertex position of the dragging anchor monitoring polygon and click the mouse button.**
The position of the vertex is changed.

Adding a vertex

- 1 Click the mouse button inside of the dragging anchor monitoring polygon.**
The [Anchor Watch] dialogue is displayed.
- 2 Click the mouse button on the position where a vertex to be added.**
The cursor is set to the Edit cursor.
- 3 Move the cursor to the position where a vertex is to be set and click the mouse button.**
A new vertex is added.

8.3.8 Changing a shape of a dragging anchor monitoring polygon on the context menu

The following operation can be performed on the context menu that is displayed by clicking the right mouse button on the dragging anchor monitoring polygon.

[Clicking the right mouse button on the line other than vertices of the dragging anchor monitoring polygon]

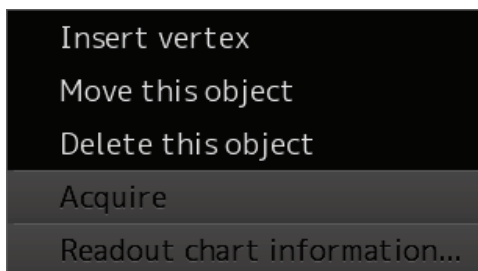

[Clicking the right mouse button on a vertex of a dragging anchor monitoring polygon]

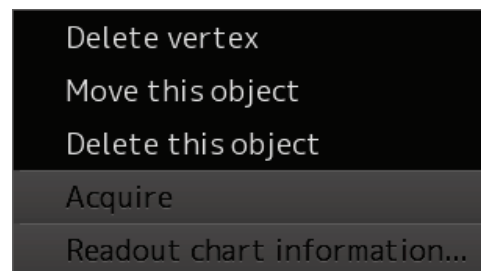

Each function is as follows.

[Insert vertex]

Adds a vertex at the position where the mouse button is clicked on.

[Delete vertex]

Deletes the selected vertex.

[Move this object]

Moves the selected dragging anchor monitoring polygon to any position.

[Delete this object]

Deletes a selected dragging anchor monitoring polygon.

Memo

If an attempt is made to delete a dragging anchor monitoring polygon during execution of dragging anchor monitoring, a confirmation dialogue appears.

To execute deletion, click on the [Yes] button. The monitoring area is deleted and dragging anchor monitoring is terminated.

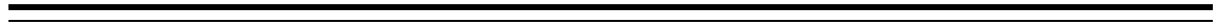

Section 9 Chart

Use the [Chart] menu for the operations relating to charts.

9.1 Common

9.1.1 Special Line

9.1.1.1 Managing special line data

Manage special line data in the Chart Maintenance menu.

Open the “Chart Maintenance” screen from the Mode Selection screen.

The [Import Special Line] button is assigned on the “Chart Maintenance” screen.

Insert the USB containing the special line data to be imported and execute Import.

The procedure for importing special line data is provided below.

1 Click on the [Import Special Line] button.

A selection screen for special line data to be imported is displayed.

2 Select special line data to be imported from the folder list in the USB and click on the [OK] button.

The [OK] button can be clicked on only when the special line data at the level that can be imported is selected from the folder list.

3 When an import verification screen is displayed, click on [OK] when continuing import.

4 When Import is successful, an import successful popup window is displayed.

Terminate the processing by clicking on the [OK] button.

When Import failed, a popup window is displayed notifying the import failure. The cause of the failure may be due to insufficient free space or removal of the USB card during import processing.

9.2 C-MAP MAX

Memo

Don't insert the SD card during startup the mode from the Mode Selection screen.

9.2.1 Warning screen

A warning screen relating to the C-MAP MAX chart is displayed at the following timing.

At startup

When the RADAR mode is selected on the mode selection screen, if any of the following conditions is satisfied, a warning screen is displayed.

- Consent has never been made on any warning screen after the power was turned on.
- C-MAP MAX is selected on the chart display menu.
- The SD card of C-MAP MAX is inserted.

Upon chart switching

When the chart is switched to C-MAP MAX on the chart display menu and the following conditions are satisfied, a warning screen is displayed.

- Consent has never been made on any warning screen after the power was turned on.
- The SD card of C-MAP MAX is inserted.

When a warning screen is displayed, read the contents of the warning carefully. When the [OK] button is clicked on, the system assumes that consent has been made and closes the warning screen.

9.2.2 C-MAP cartridge information

Cartridge information of C-MAP can be displayed.

[Operation procedure]

Open the Cartridge Information screen by performing the following menu operations.

[Menu] button → Chart → Cartridge Information

9.2.2.1 Contents of C-MAP cartridge information

The following contents are displayed on the “Cartridge Information” screen.

| Display item | Display contents |
|-------------------|---|
| Cartridge Code | Displays the cartridge code. For the details, refer to “9.2.2.2 Cartridge code”. |
| Description | Displays the name of the cartridge. |
| Geographical Area | Displays the geographical area that is defined by the area code. For the details, refer to “9.2.2.3 Area code”. |
| Cartridge Type | Displays the cartridge type. One of the following types is displayed: Marine / Terrestrial / Aeronautical / Submarine / Inland Waters / Road |
| Release Date | Displays the release date. The information expires one year after the date of release and an expiration warning screen is displayed. Read the contents of the warning carefully and click on the [OK] button. The system assumes that consent has been made and closes the screen. |
| Release Version | Displays the release version. |

9.2.2.2 Cartridge code

The cartridge code that is contained in the C-MAP cartridge information is displayed in the format of “XX-Yxxx-yy”.

The meaning of each field is as follows.

| Field | Contents |
|-------|--|
| XX | Area code (for the details, refer to 9.2.2.3 Area code.) |
| Y | Generation ID |
| xxx | Serial number |
| yy | Data version |

9.2.2.3 Area code

The table below shows the correspondence between the area code that is contained in the cartridge information and the area name.

| Area code | Area name |
|-----------|-------------------------|
| AF | Africa |
| AN | North Asia |
| AS | South Asia |
| AU | Australia/New Zealand |
| CA | Central America |
| CU | Custom |
| DM | Demonstration |
| EM | Mediterranean |
| EN | Northern Europe |
| EW | Western Europe |
| IN | Indian Ocean |
| ME | Middle East |
| NA | North America |
| PC | Pacific Ocean territory |
| RS | Russia |
| SA | South America |
| WW | Worldwide |

9.2.3 Searching for a port or service

This function searches for a port or service around the specified coordinates.

When [Search Port or Service] is selected from the context menu that is displayed when you right-click on the screen, the “Search Port or Service” screen is opened and a search starts.

The following items are displayed on the search screen.

| Item | Contents | Setting value |
|---|---|--|
| Search Position | Displays the specified coordinates under which a port or a service is searched for. The coordinates when the context menu was opened by right-clicking are displayed. | - |
| Port or Service | Select a target to be searched for. | Port (always displayed) Item that is selected on the “Search Service Setting” screen. |
| [Search Service Setting] button | Clicking on this button opens the “Search Service Setting” screen. To search for a service, check the check box for the service to be searched for on this screen. A service can be selected from the Port and Service combo box. | - |
| [] input box | A port or a service is searched for based on the contents that are input. | Up to 32 characters No input is acceptable. |
| Search Range | Specify a search range based on the specified coordinates. | 0.1 to 99.9 NM |
| Level | Specify a level of the port or the service to be searched for. A level is assigned to a port or service and the port or the service is displayed or hidden according to the display scale. When the [Current Level] check box is checked, this item cannot be specified. | W (Wide) Z A B C D E F G (Detail) |
| Current Level | Sets the level of the port or the service to be searched for to the level according to the current display scale. | Enable: Checked Disable: Unchecked |
| [Search] button | When this button is clicked on, search for a port or a service starts. At completion of the search, the result is displayed in the search result list. | - |

9.2.4 Pick report (C-MAP MAX)

This function retrieves information from an object on a chart and displays it on the pick report screen. When you right-click on a chart and then select [Readout Chart Information] from the displayed context menu, the pick report screen is opened, enabling the checking of chart information.

The following contents are displayed on the pick report screen for C-MAP MAX.

[Object] tab

| Item | Contents | Setting value |
|----------------|---|------------------------------|
| Geometry | Select geometry. The display contents are filtered based on the selected geometry. All --- All the objects are displayed without filtering. Point --- Only the point object is displayed. Line --- Only the line object is displayed. Area --- Only the area object is displayed. | All Point Line Area |
| Object List | | |
| Picked Objects | Displays in the list the objects within the pick cursor. | - |
| Name | Displays the name of the selected object. | Point Line Area |
| Attribute List | | |
| Attribute | Displays the attribute name of the object that has been selected from the object list. | - |
| Value | Displays the attribute value of the object that has been selected from the object list. When the value is unknown, "Unknown" is displayed. | - |

[Legend] tab

| Item | Contents | Setting value |
|-----------------------|--|--|
| Area Information List | | |
| Information | Displays the area information of the point that has been picked. | Scale Depth Unit Height Unit Update Application Date (UTC) Position Referred To Source Indication Height Referred Buoyage System |
| Value | Displays the value of the area information. When the value is unknown, "Unknown" is displayed. | |

9.3 newpec

9.3.1 Warning screen

A warning screen relating to the newpec chart is displayed at the following timing.

At startup

When the RADAR mode is selected on the mode selection screen, if any of the following conditions is satisfied, a warning screen is displayed.

- Consent has never been made on any warning screen after the power was turned on.
- newpec is selected on the chart display menu.

Upon chart switching

When the chart is switched to newpec on the chart display menu and the following conditions are satisfied, a warning screen is displayed.

- Consent has never been made on any warning screen after the power was turned on.

When a warning screen is displayed, read the contents of the warning carefully. When the [OK] button is clicked on, the system assumes that consent has been made and closes the warning screen.

9.3.2 Managing the newpec chart

Manage chart data on the Chart Maintenance menu.

Open the “Chart Maintenance” screen from the Mode Selection screen.

The [Import newpec chart] button is provided on the “Chart Maintenance” screen.

Insert the USB containing new chart data and execute import.

The newpec chart import procedure is shown below.

1 Click on the [Import newpec chart] button.

The newpec import selection screen is displayed.

2 Select the newpec data that is stored in USB from the folder list for import and click on the [OK] button.

The [OK] button can be clicked on only when a layer into which the newpec can be imported is selected from the folder list.

3 When an import confirmation screen is displayed, click on the [OK] button to continue import.

Since the old data is deleted when the [OK] button is clicked on the import confirmation screen, newpec can no longer be used if the execution is cancelled before completion.

4 When import is completed successfully, a successful import popup window is displayed. Terminate the processing by clicking on the [OK] button.

If import fails, a popup window is displayed indicating the failure. The possible failure causes are insufficient storage space and removal of the USB card during import processing, among others.

9.3.3 Pick report (newpec)

This function retrieves information on an object on a chart and displays it on the pick report screen.

When you right-click on a chart and then select [Readout Chart Information] from the displayed context menu, the pick report screen is opened, enabling the checking of chart information.

The following contents are displayed on the pick report screen for newpec.

| Item | Contents |
|----------------|---|
| Object List | |
| Picked Object | Displays in the list the objects within the pick cursor. |
| Name | Displays the name of the object. |
| Attribute List | |
| Attribute | Displays the additional information of the object that has been selected from the object list. |
| Value | Displays the value of the additional information of the object that has been selected from the object list. |

Section 10 Creating a User Map

This Section describes the procedure for creating a user map.

User map

A user specific map can be created by drawing various objects (mark, line, area, and text) that are not displayed on the existing chart. The created user map can also be updated by editing.

A user map can be displayed by overlapping on a chart. A user map can be created by merging two user maps.

The following diagrams show how to use user maps.

Display example 1

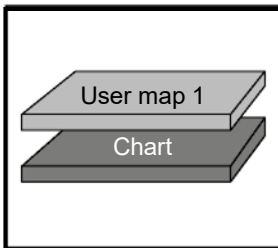

Display example 2

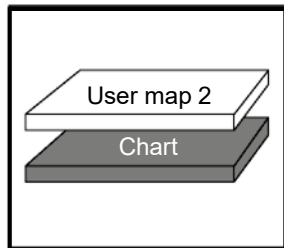

Display example 3

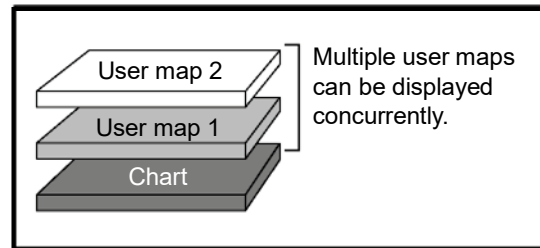

Example: User maps 1 and 2 are merged and displayed on a chart by overlaying.

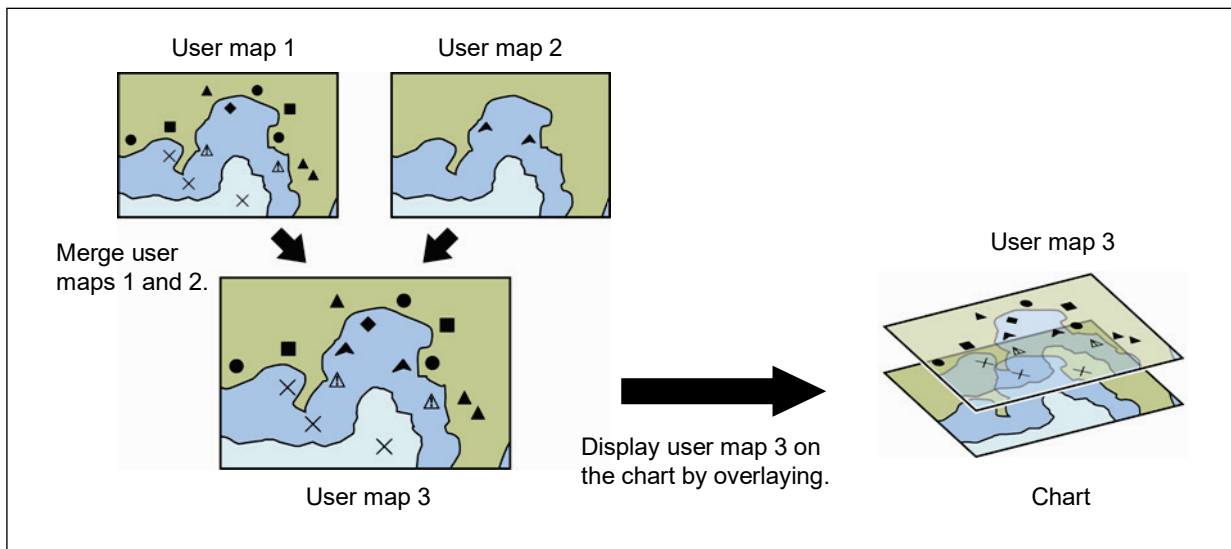

10.1 Display the "User Map" menu

Use the "User Map" menu when creating/editing a user map.

[Operation procedure]

Open the "User Map" menu by performing the following menu operations.

[Menu] button → User Map

The "User Map" menu comprises the following submenus.

| Submenu | Function |
|-----------------------|---|
| File Operation | <ul style="list-style-type: none">• Managing user map files (new creation, copying, deletion)• Displaying/editing a user map• Merging user map files Refer to "10.2 Creating/Editing a User Map". |
| Mark Line/List | Managing/editing objects Refer to "10.3 Managing/Editing an Object [Mark/Line List]". |
| Delete by Type/Colour | Deleting objects collectively Refer to "10.4 Bulk Deletion of Objects [Delete by Type/Colour]". |

10.2 Creating/Editing a User Map

Use the following procedure to create/edit a user map.

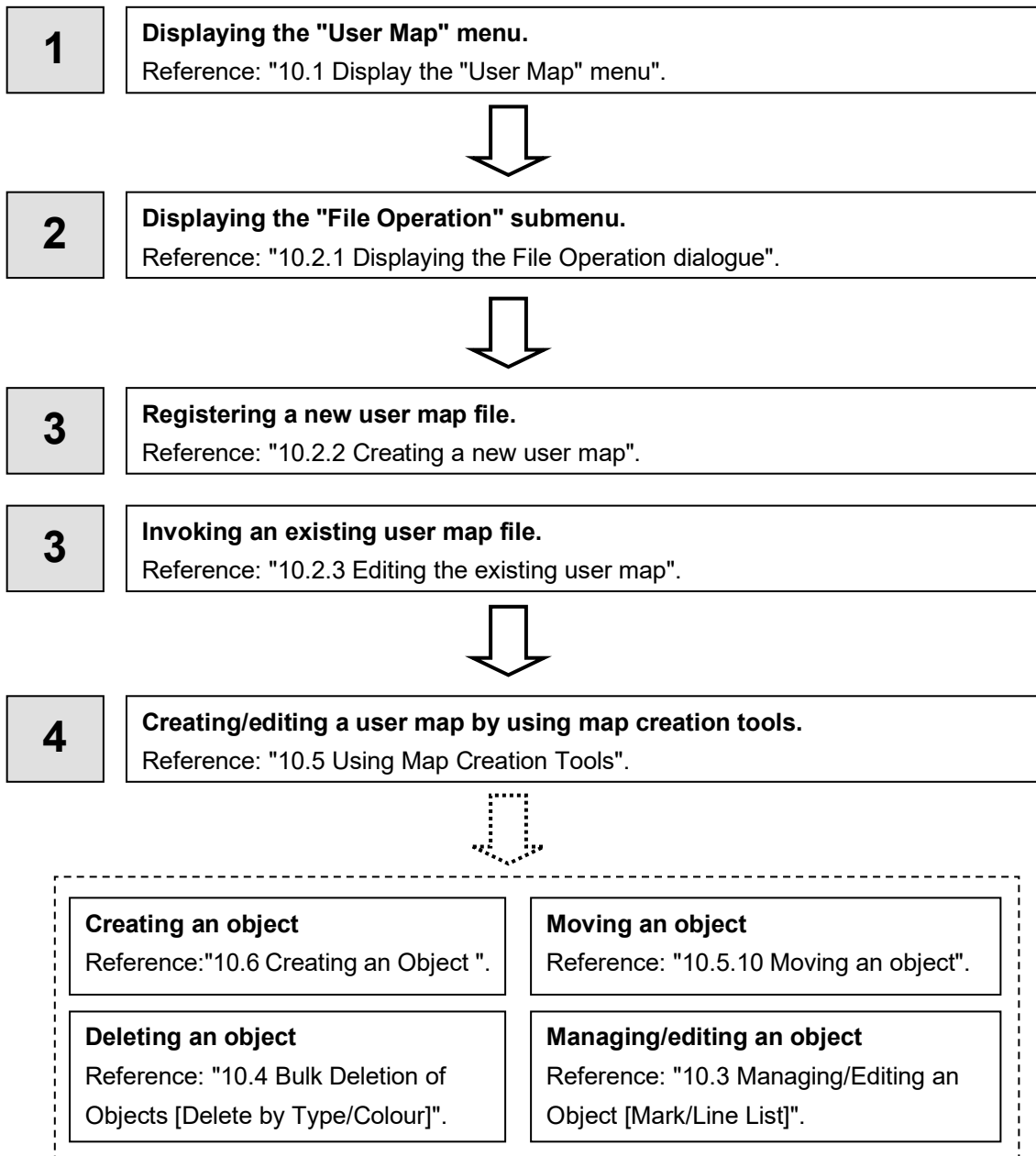

10.2.1 Displaying the File Operation dialogue

Manage the file at user map creation and display and edit the user map on the [File Operation] dialogue box.

[Operation procedure]

Open the File Operation dialogue by performing the following menu operation.

[Menu] button → User Map → File Operation

10.2.1.1 [File Operation] dialogue

The user map files that are currently saved are displayed in the file list.

The number of objects that are displayed is indicated at the bottom right corner of the dialogue.

File list

Up to 500 user map files (.uchr) can be registered in a file list. The following information is displayed for the user map files that are currently saved.

| Item | Information |
|------------------------------------|--|
| [Name] | Indicates the name of the user map file (up to 64 characters). The name can be changed by clicking on the name in the list. |
| [Count] | Indicates the total number of objects that are registered in the user map file. |
| [Comment] | Indicates the comment on the user map file (up to 64 characters). The comment can be changed by clicking on the comment in the list. |
| [Date (UTC)] (Last update date) | Last update date of the user map file |
| [Geodetic] | Displays the geodetic datum of the user map file. |
| [Display] | The [Display] check box is checked for the user map file that is displayed. For the method of using the [Display] check box, refer to "10.2.4 Displaying a user map". |
| [Editing] | The [Editing] button is set to ON for the user map file that is being created or edited. For the method of using the [Editing] button, refer to "10.2.3 Editing the existing user map". |

File operation buttons

| Button name | Function |
|-------------|---|
| [New] | Creates a new user map file. For the details, refer to "10.2.2 Creating a new user map". |
| [Delete] | Deletes a user map file. For the details, refer to "10.2.5.1 Deleting a user map file". |
| [Copy] | Copies a user map file For the details, refer to "10.2.5.2 Copying a user map file". |

[Merge Display Files] button

This button merges the selected user map files.

For the details, refer to "10.2.5.3 Merging multiple user map files".

[Edit User Map] button

This button edits the existing user map file.

For the details, refer to "10.2.3 Editing the existing user map".

10.2.2 Creating a new user map

1 Click on the [New] button.

The new user map file is registered in the file list.

The file name can be changed by clicking on the file name that is displayed in the [Name] column in the file list.

2 Click on the [Edit User Map] button in the [File Operation] dialogue.

The map creation tool is displayed.

Create or edit the user map by using the map creation tool. (Refer to "10.5 Using Map Creation Tools").

10.2.3 Editing the existing user map

1 Click on the [Editing] button of the user map file to be edited in the file list on the [File Operation] dialogue.

The user map file to be edited is displayed.

2 Click on the [Edit User Map] button on the [File Operation] dialogue.

The map creation tools (drawing toolbar and the user map information bar) are displayed and the cursor changes from the cross-hair cursor to the mark cursor. Edit the user map by using the map creation tools. (Refer to "10.5 Using Map Creation Tools").

10.2.3.1 Editing the user map that is currently displayed

1 Display a user map. (Refer to "10.2.4 Displaying a user map").

2 Click on the Write tool button on the Tool Bar.

The map creation tools (drawing toolbar and the user map information bar) are displayed and the cursor changes from the cross-hair cursor to the mark cursor.

3 Edit the user map by using the map creation tools. (Refer to "10.5 Using Map Creation Tools").

4 To edit another user map, click on the [File Operation] dialogue display button on the user map information bar. (Refer to "10.5 Using Map Creation Tools").

The [File Operation] dialogue box appears.

5 Click on the [Editing] button of the user map file to be edited in the file list on the [File Operation] dialogue.

The selected user map is displayed.

10.2.4 Displaying a user map

1 Select the [Display] check box of the user map file to be displayed in the file list on the [File Operation] dialogue.

The selected user map is displayed.

10.2.5 Operating a user map file

Manage the file at user map creation and merge user maps on the [File Operation] dialogue.

10.2.5.1 Deleting a user map file

- 1 Click on the user map file to be deleted in the file list.

The user map file is selected.

- 2 Click on the [Delete] button.

The selected user map file is deleted.

10.2.5.2 Copying a user map file

- 1 Click on the file to be copied in the file list.

The user map file is selected.

- 2 Click on the [Copy] button.

The selected user map file is copied.

The copied file is named under "Copy of (copy source file name)".

Memo

If the file name exceeds 64 characters including "Copy of", the file cannot be copied.

10.2.5.3 Merging multiple user map files

- 1 Select the [Display] check boxes of the files to be merged in the file list.

The user map files to be merged are displayed.

- 2 Click on the [Merge Display Files] button.

A user map file is created by merging the user maps that are being displayed. The merged user map file is named under "Merged User Map Filexxx" (xxx: serial number starting from 001).

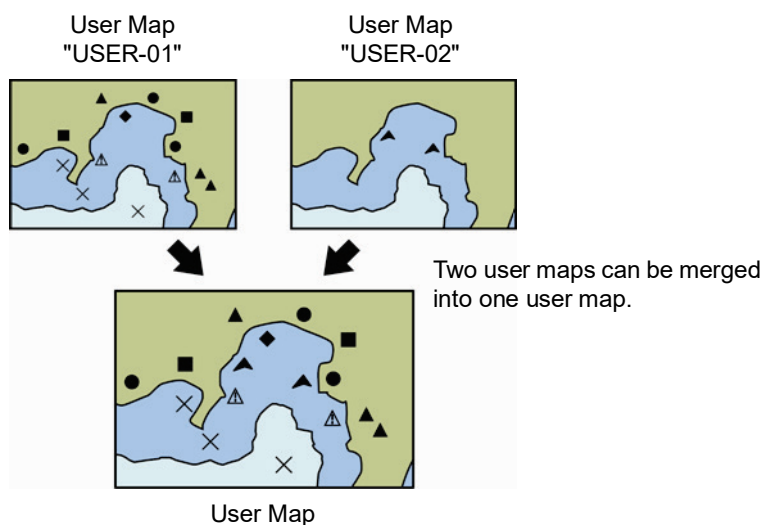

10.3 Managing/Editing an Object [Mark/Line List]

Objects of a user map can be managed/edited on [Mark/Line List].

[Operation procedure]

Open the [Mark/Line List] screen by performing the following menu operations.

[Menu] button → User Map → Mark/Line List

10.3.1 Displaying a user map list

Display the user map list that is currently displayed.

The display of each category can be switched by clicking on the [Mark] button, [Line] button, or [Text] button.

10.3.1.1 Copying an object

Select a line of the object to be copied and click on the [Insert] button.

10.3.1.2 Deleting an object

Select a line of the object to be deleted and click on the [Delete] button.

Memo

When the [Delete] button is clicked on, the object is deleted immediately. Reconfirm if the object can be deleted before clicking on the [Delete] button.

10.4 Bulk Deletion of Objects [Delete by Type/Colour]

[Delete by Type/Colour] enables deletion of objects of the same type or colour in bulk.

[Operation procedure]

Open the Mark/Line deletion screen by performing the following menu operations.

[Menu] button → User Map → Delete by Type/Colour

- 1 Select a parameter common to the objects to be deleted from the list in the [Type] combo box or [Colour] combo box.**

When [All] is selected, all the objects are deleted.

- 2 Click on the [OK] button.**

10.5 Using Map Creation Tools

Use the map creation tools to create/edit a user map.

The following tools can be used for user map creation.

10.5.1 User map information bar

The user map information bar is located at the bottom right of the screen and displays the user map name that is currently being created/edited.

[Operation procedure]

Display the user map information bar by performing the following menu operations.

[Menu] button → User Map → File Operation

1 Click on the [Edit User Map] button.

The user map information bar is displayed in the bottom right of the screen.

The user map information bar can also be displayed by clicking on the write tool button on the toolbar.

The [File Operation] dialogue can be displayed by clicking on the [File Operation] dialogue display button.

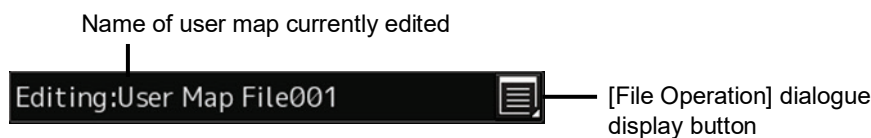

10.5.2 Drawing toolbar

Use a drawing toolbar for creating a user map.

Display a drawing toolbar by clicking on the [Drawing tool] button on the toolbar on the top screen.

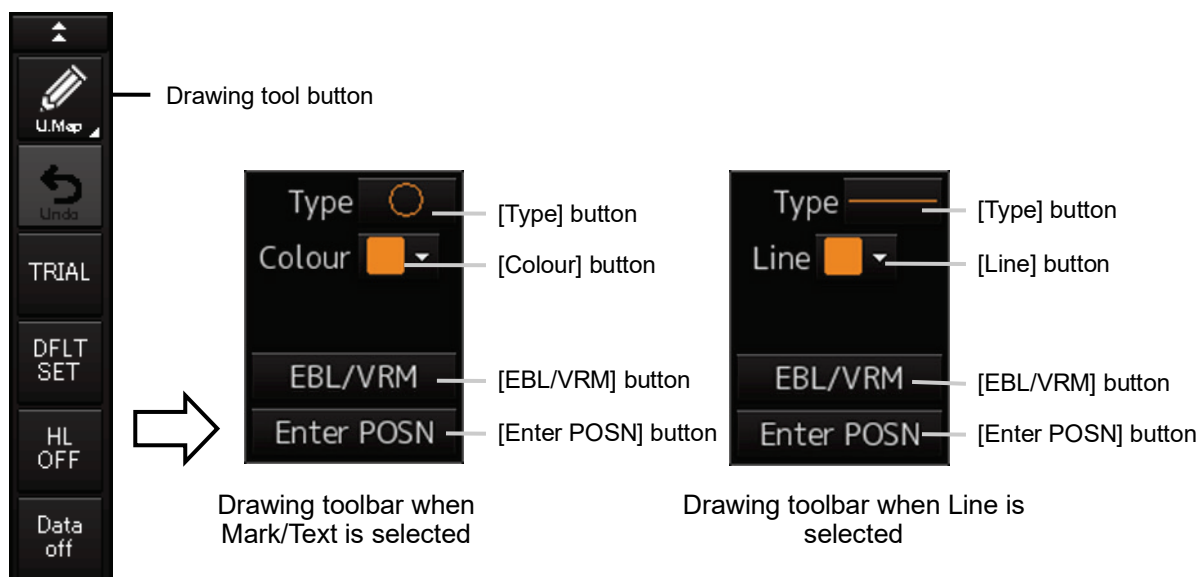

At creation of a user map, "U.Map" is displayed on the drawing tool button.

Memo

At user map creation, the azimuth mode is fixed to the [N UP] mode.

A drawing toolbar comprises the following tool buttons. The buttons that are assigned vary according to the type of the object that is currently selected (Mark/Line/Text).

| Tool button | Function |
|---|--|
| [Type] button | Displays an icon list dialogue. (Refer to "10.5.3 Selecting an object type".). |
| [Colour] button (when Mark/Text is selected) | Select the colour of the mark/text. (Refer to "10.5.4 Selecting a colour of an object".). |
| [Line] button (when Line is selected) | Enables selection of a colour of the line that forms the object. (Refer to "10.5.4 Selecting a colour of an object".). |
| [EBL/VRM] button | Switches the cursor mode of the user map creation function to the EBL/VRM mode. (Refer to "10.5.5 Creating an object in the EBL/VRM mode".). |
| [Enter POSN] ([Enter Position] dialogue display) button | Displays the [Enter Position] dialogue (Refer to "10.5.6 Creating an object by specifying latitude and longitude".). |

10.5.3 Selecting an object type

By displaying an icon list dialogue, the type of the object ([Mark], [Line], or [Text]) for the user map can be selected.

1 Click on the [Type] button on the drawing toolbar.

An icon list dialogue is displayed.

2 Select a type of the object (Mark/Line/Text) to be used on the user map menu of the icon list dialogue and select an icon.

For the icons that can be selected for each object type, refer to "Appendix D.5 Icon Button List for User Map".

10.5.4 Selecting a colour of an object

Select a required colour from the list that is displayed.

1 Click on the [Colour] button (when selecting Mark/Text) or the [Line] button (when selecting Line) on the drawing toolbar.

A colour list is displayed.

2 Select a required colour from the list that is displayed.

The following 10 colours are available.

| | |
|---------|----------|
| White | Cyan |
| Grey | Green |
| Amber | Yellow |
| Magenta | Orange |
| Blue | Dark Red |

10.5.5 Creating an object in the EBL/VRM mode

- 1 Click on the [EBL/VRM] button on the drawing toolbar.

The user map creation function mode is switched from the cursor mode to the EBL/VRM mode. When the mode is switched to the EBL/VRM mode, the cursor changes to the following state.



EBL/VRM base point cursor

The EBL/VRM mode is switched to cursor mode when the right mouse button is clicked on the chart or the [Enter POSN] button on the drawing toolbar is clicked on.

10.5.6 Creating an object by specifying latitude and longitude

Using the [Enter Position] dialogue, it is possible to create an object at the specified latitude and longitude.

Displaying the [Enter Position] dialogue

- 1 Click on the [Enter POSN] button on the drawing toolbar.

Memo

An object cannot be created with the cursor mode and EBL/VRM mode while this dialogue is displayed.

10.5.6.1 Creating an object of Mark/Text

Enter latitude and longitude values of the object in the [Position] box and click on the [Enter] button. The [Bearing] box, [Distance] box, and the [New] button are disabled.

10.5.6.2 Creating an object of Line

Use the following procedure to create an object with vertices such as Line.

- 1 Enter latitude and longitude values of a vertex of the object in the [Position] box and click on the [Enter] button.
The position of one of the vertices of the object is determined.
The [Bearing] box and the [Distance] box are enabled.
- 2 Enter latitude and longitude values of the next vertex in the [Position] box. Alternatively, enter the bearing and distance from the previous vertex that was determined in the [Bearing] box and the [Distance] box.
- 3 Click on the [Enter] button.
- 4 Repeat Steps 2 and 3.
A line can be determined by two or more vertices.
- 5 To create an object continuously on another position, click on the [New] button.

10.5.7 Deleting an object

- 1 Click on the eraser tool button on the toolbar.

The cursor changes to the eraser cursor.



- 2 Place the cursor on the eraser cursor and click the mouse button.

When the right button is clicked on any position with the eraser cursor, the cursor mode is reset to the cross-hairs cursor.

Objects of the same shape or colour can be deleted collectively. For the details, refer to "10.4 Bulk Deletion of Objects [Delete by Type/Colour]".

10.5.8 Object property dialogue

An object property dialogue displays the properties of the object that is currently selected.

Parameter settings of the object can be verified/changed.

10.5.8.1 Selecting an object

- 1 Click on the object to be selected with the cross-hairs cursor.

The object is selected and the object property dialogue appears.



10.5.8.2 Setting a comment

In the object property dialogue, a comment for the object can be entered. When the [Show Comment] check box is selected, a comment can be displayed on the user map.

- 1 Enter a comment in the [Comment] box (up to 64 characters).
- 2 To display the comment that is input on the user map, select the [Show Comment] check box.

10.5.9 Changing an object display scale range

An object display scale range (1:1 to 1:100,000,000) can be changed on the object property dialogue.

- 1 Select a minimum scale on the [MIN scale] combo box.
- 2 Select a maximum scale on the [MAX scale] combo box.

10.5.10 Moving an object

To move an object, use the context menu that is displayed by clicking the right button on the object.

- 1 **When the object to be moved is in the selected state, unselect the object.**
To unselect the object, click on a section without display or another object.



- 2 **Click the right button on the object.**

The object is selected and the context menu is displayed.

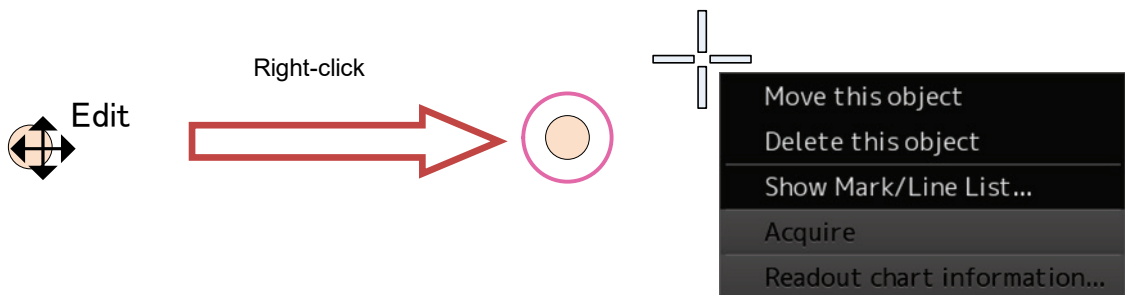

- 3 **Click on [Move this object].**
- 4 **Click on the position to which the object is to be moved.**
The selected object moves to the position on which the button was clicked.

10.6 Creating an Object

This section describes the procedures for creating an object on the chart of the user map and to change the parameters of the object.

Memo

After automatic sailing, the mark/line may be shifted depending on how the cursor is placed on the target at the input.

To prevent the shift, place the cursor on the front edge of the target.

- Input method that does not cause shift (place the cursor on the front edge of the target)

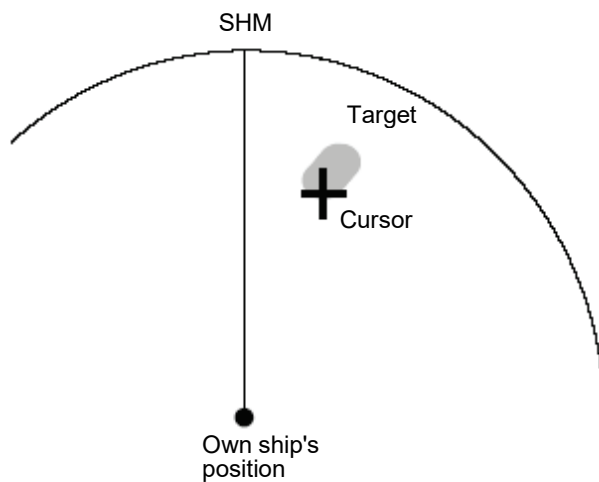

- Input method that causes shift (place the cursor on the centre of the target)

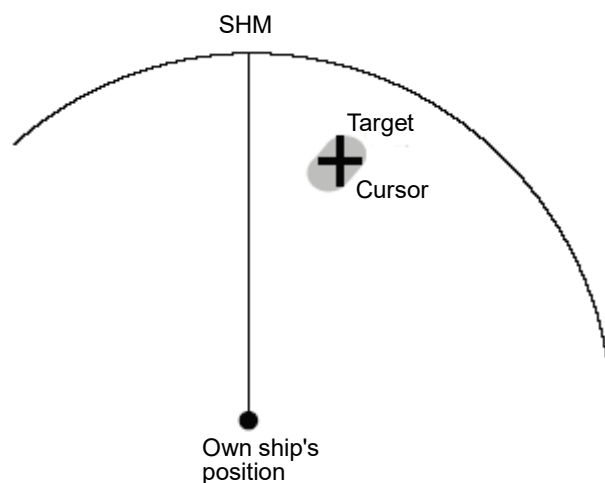

10.6.1 Creating a mark (Mark object)

A mark can be created by specifying the creation position with the cursor.

1 Click on the [Type] button on the drawing toolbar.

An icon list dialogue is opened.

Select an icon of the mark. (Refer to "10.5.3 Selecting an object type").

2 Click on the position on which the mark is to be created by using the cursor.



The mark is displayed on the position on which the mouse button was clicked and the parameters of the mark that was created are displayed in the object property dialogue.

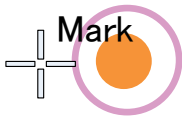

3 Adjust the parameters on the object property dialogue.

4 To create an object on another position continuously, repeat Steps 2 and 3.

10.6.1.1 Creating an object by specifying the latitude and longitude

1 Click on the [Enter POSN] button on the drawing toolbar.

The [Enter Position] dialogue appears (Refer to "10.5.6 Creating an object by specifying latitude and longitude").

2 Enter the latitude and longitude of the position on which an object is to be created and click on the [Enter] button.

An object is created on the specified latitude and longitude and the property information is reflected in the object property dialogue. (Refer to "10.5.8 Object property dialogue").

3 Adjust the parameters on the object property dialogue.

4 To create an object on another position continuously, repeat Steps 2 and 3.

At user map creation, the mark size can be changed by selecting [View] – [User Map].
For the details, refer to "11.1.4 Setting up the display of User Map".

10.6.1.2 Creating an object with EBL/VRM operation

1 Click on the [EBL/VRM] button on the drawing toolbar.

The cursor changes to the EBL/VRM reference point cursor. (Refer to "10.5.5 Creating an object in the EBL/VRM mode").

2 Click on the position of the reference point of the EBL/VRM marker.

The EBL/VRM marker is displayed.

3 Place the EBL/VRM marker on the position on which the object is to be created and click the button.

An object is created on the position on which the button was clicked and the property information is reflected in the object property dialogue. (Refer to "10.5.8 Object property dialogue").

4 Adjust the parameters on the object property dialogue.

5 To create an object on another position continuously, repeat Steps 2 to 4.

10.6.2 Creating a line (Line object)

The line is created by using one vertex as one object.

1 Click on the [Type] button on the drawing toolbar.

An icon list is opened. Select an icon of the line. (Refer to "10.5.3 Selecting an object type").

2 Click on the starting point with the cursor.

A vertex is created and the property information of the vertex is displayed on the object property dialogue.

3 Move the cursor to the next vertex.

The latitude and longitude of the cursor are displayed near the cursor.

4 Click on the position on which the 2nd vertex is to be created.

A vertex is created and the parameters of the 2nd vertex are displayed on the object property dialogue.

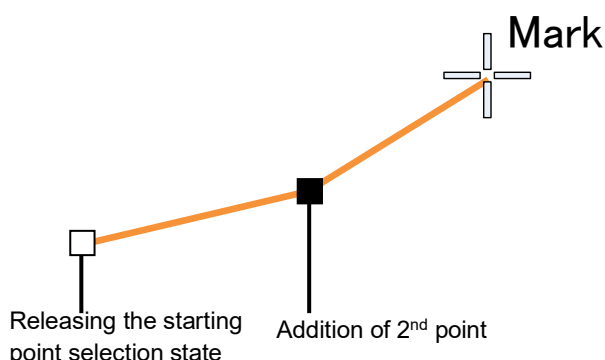

5 Determine the Line by double-clicking on the button or right-clicking the button.

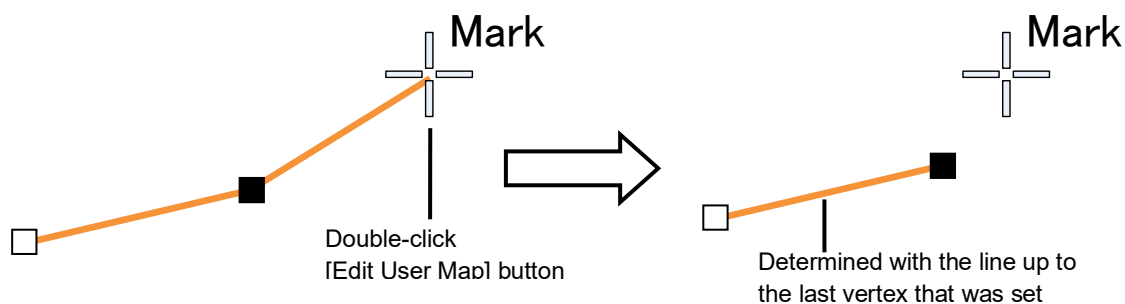

6 Adjust the parameters on the object property dialogue.

7 To create an object on another position continuously, repeat Steps 2 to 6.

Memo

The property screen for the vertex that was created can be edited in AUTO mode.

For the details of AUTO mode, refer to "3.15 Cursor AUTO Mode".

10.6.2.1 Creating a vertex by entering the position

- 1** Click on the [Enter POSN] button on the drawing toolbar.
The [Enter Position] dialogue appears.
- 2** Enter the values of latitude and longitude of the vertex of the object in the [Position] box and click on the [Enter] button.
The position of the vertex of the object is determined.
The [Bearing] box and the [Distance] box are enabled.
- 3** Enter the values of the latitude and the longitude of the next vertex in the [Position] box. Alternatively, enter the bearing from the vertex that was determined immediately previously in the [Bearing] box and the [Distance] input box.
- 4** Click on the [Enter] button.
- 5** Adjust the parameters on the object property dialogue.
- 6** To create an object in another position continuously, click on the [New] button of the [Enter Position] dialogue and repeat Steps from 2 to 5.

10.6.2.2 Creating an object with EBL/VRM operation

1 Click on the [EBL/VRM] button on the drawing toolbar.

The cursor changes to the EBL/VRM reference point cursor. (Refer to "10.5.5 Creating an object in the EBL/VRM mode").

2 Click on the position of the reference point of the EBL/VRM marker.

The EBL/VRM marker is displayed.

3 Place the EBL/VRM marker on the starting point and click the button.

A vertex is created on the position on which the button was clicked and the information is reflected in the object property dialogue. (Refer to "10.5.8 Object property dialogue").

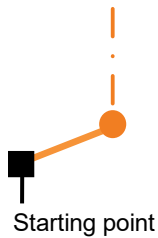

4 Click on the position of the reference point.

The EBL/VRM marker that determines the 2nd point is displayed.

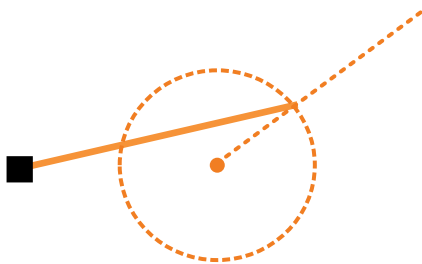

5 Place the EBL/VRM marker on the 2nd vertex and click the button.

A vertex is created on the position on which the button was clicked and the information is reflected in the object property dialogue. (Refer to "10.5.8 Object property dialogue").

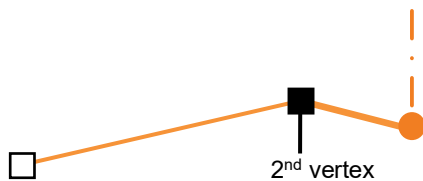

The EBL/VRM marker is reset to the EBL/VRM reference point cursor.

6 Adjust the parameters on the object property dialogue.

7 To create an object on another position continuously, repeat Steps 2 to 6.

10.6.3 Creating a text (Text object)

Any character information can be displayed on the user map.

1 Click on the [Type] button on the drawing toolbar.

An icon list dialogue is opened.

Select a text (Txt) icon. (Refer to "10.5.3 Selecting an object type").

2 With the cursor, click on the position on which an object is to be created.



A text box is created at the position on which the button was clicked and a text is displayed.



The parameters of the text that was created are displayed on the object property dialogue.

3 Adjust the parameters on the object property dialogue.

For the text input method, refer to "10.6.3.3 Editing a text", for the template usage method, refer to "10.6.3.4 Editing a template", and for the text angling method, refer to "10.6.3.5 Changing a text angle".

4 To create an object on another position continuously, repeat Steps 2 and 3.

10.6.3.1 Creating a text by specifying the latitude and longitude

1 Click on the [Enter POSN] button on the drawing toolbar.

The [Enter Position] dialogue appears (Refer to "10.5.6 Creating an object by specifying latitude and longitude").

2 Enter the latitude and longitude of the object to be created and click on the [Enter] button.

An object is created on the specified latitude and longitude and the property information is reflected in the object property dialogue. (Refer to "10.5.8 Object property dialogue").

3 Adjust the parameters on the object property dialogue.

For the text input method, refer to "10.6.3.3 Editing a text", for the template usage method, refer to "10.6.3.4 Editing a template", and for the text angling method, refer to "10.6.3.5 Changing a text angle".

4 To create an object on another position continuously, repeat steps 2 and 3.

10.6.3.2 Creating a text with EBL/VRM operation

- 1 Click on the [EBL/VRM] button on the drawing toolbar.**

The cursor changes to the EBL/VRM reference point cursor. (Refer to "10.5.5 Creating an object in the EBL/VRM mode").
- 2 Click on the position of the reference point position of the EBL/VRM marker.**

The EBL/VRM marker is displayed.
- 3 Place the EBL/VRM marker on the position on which an object is to be created and click the button.**

An object is created on the position on which the button was clicked and the property information is reflected in the object property dialogue. (Refer to "10.5.8 Object property dialogue").
- 4 Adjust the parameters on the object property dialogue box.**

For the text input method, refer to "10.6.3.3 Editing a text", for the template usage method, refer to "10.6.3.4 Editing a template", and for the text angling method, refer to "10.6.3.5 Changing a text angle".
- 5 To create an object on another position continuously, repeat Steps 2 to 4.**

10.6.3.3 Editing a text

- 1 Click on the [Text] input box**

A character input full keyboard is displayed.
- 2 Create a text.**

For the method of using the character input full keyboard, refer to "3.19.2 Name and function of each section of the keyboard".
- 3 Close the character input full keyboard by clicking on the [Enter] key.**
- 4 To change a character colour, select a required character colour from the [Colour] combo box.**
- 5 To change a font size, select a required font size from the [Font Size] combo box.**

10.6.3.4 Editing a template

By registering a frequently used text as a template, the template can be used at text creation.

1 Click on the [Edit Template] button.

The [Template] dialogue appears.

2 Click on a text input area.

A character input full keyboard is displayed.

3 Create a text.

For the method of using the character input full keyboard, refer to "3.19.2 Name and function of each section of the keyboard".

4 Close the character input full keyboard by clicking on the [Enter] key.

5 Click on the [Register] button.

6 Close the [Template] dialogue and click on [▼] on the right side of the text input area of the object properties dialogue.

[Template List] is displayed.

7 Select any template.

8 To delete unnecessary templates, select unnecessary templates in the [Template List] and click on the [Delete] button.

10.6.3.5 Changing a text angle

Under the factory setting, a text is oriented horizontally. The text can be angled or inverted according to the text creation position.

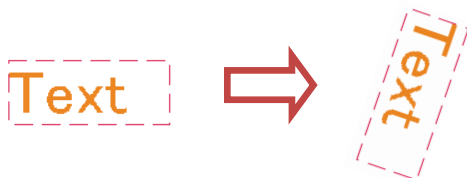

1 Click on the [Angle] input box.

A numeric value input keyboard is displayed.

2 Enter an angle.

Specify an angle in clockwise based on the direction of the 12 O'clock as 0°. Under the factory setting, the angle is set to 90° (horizontal).

For the method of using the numeric value input keyboard, refer to "3.19.2 Name and function of each section of the keyboard".

Section 11 Setting up Screen View

Screen display detail is set through the [View] menu.

11.1 Setting Screen Display Options

In the [View] dialogue, screen display options can be set.

Display targets for classification pane

The following table shows the classification panes that are displayed and the reference sections.

| Classification pane | Reference |
|---------------------|--|
| Own Ship | 11.1.1 Setting up the display of own ship symbol |
| Own Track | 11.1.2 Setting up the display of own ship's tracks |
| Past Position | 11.1.3 Setting up the display of the past position |
| User Map | 11.1.4 Setting up the display of user map |
| RADAR | 11.1.5 Setting up transparency of echo/radar trails |
| Target | 11.1.6 Setting up the display of TT/AIS target |
| Target Track | 11.1.7 Setting up the display of other ship's track |
| Chart View | 11.1.8 Setting a chart |
| C-MAP MAX | 11.1.9 Setting up the display of C-MAP MAX |
| newpec | 11.1.10 Setting up the display of newpec |
| Tools | 11.1.11 Setting up the display of range/bearing measurement function |
| Unit | 11.1.12 Setting up the display of unit of setting value |
| Control | 11.1.13 Setting control of the top screen and menus |
| Depth Graph | 11.1.14 Setting up the display of depth graph |
| Water TEMP Graph | 11.1.15 Setting up the display of water temperature graph |

11.1.1 Setting up the display of own ship symbol

Configure the setting for own ship symbols.

[Operation procedure]

Open the display setting screen of the own ship symbol by performing the following menu operations.

[Menu] button → View → Own Ship

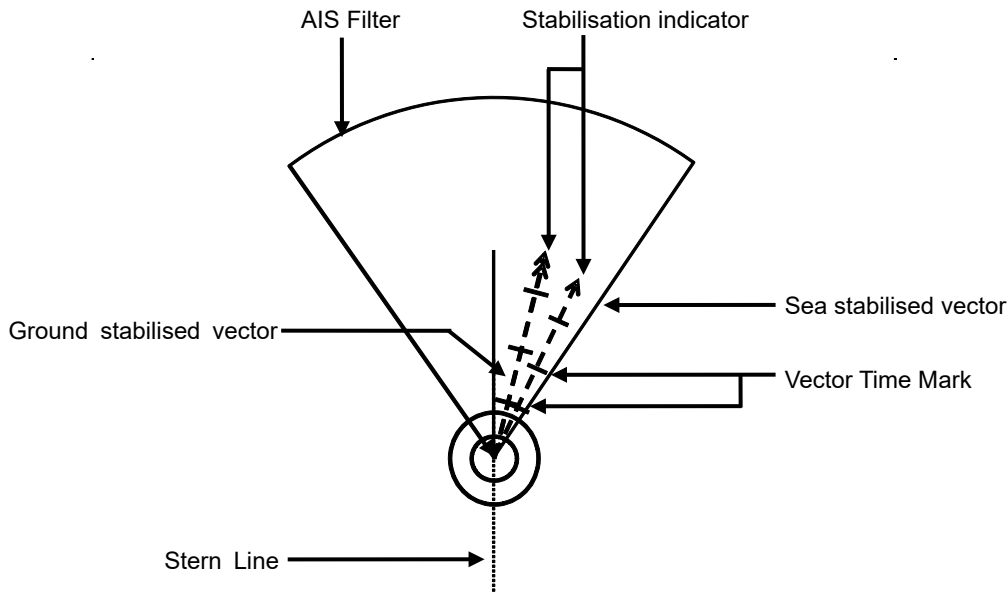

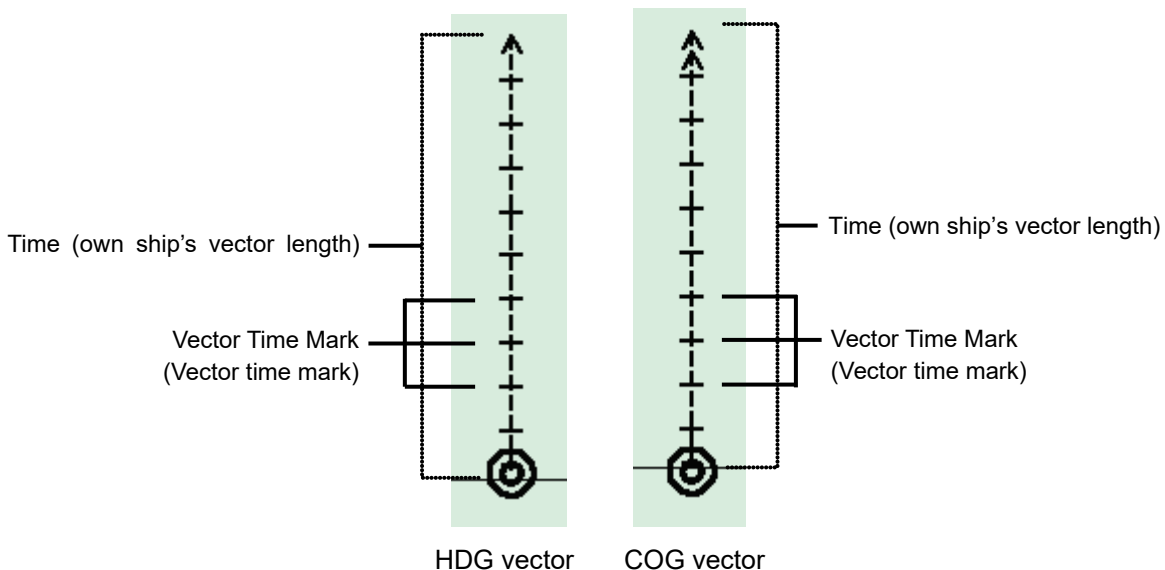

Vector display at primary position

In the own ship symbol, COG (Course Over the Ground) vector, HDG (Heading) vector, and heading line can be displayed. The COG or HDG vector can also be displayed by the length proportionate to the current ship speed in minute by the setting. For example, when the vector length is set to 10 minutes, the vector tip is at the predicted position after 10 minutes if the ship is assumed to navigate at the current speed.



- To display COG (Course Over the Ground) vector, select [Ground stabilised vector] in [Vector].
- To display the HDG (ship's heading) vector, select [Sea stabilised vector] in [Vector].

For details on the setting of type and length of the vector to be displayed, refer to the following table.

| Setting Item | Description of Setting | Setting Value |
|---|---|--|
| Type | Select an own ship symbol from the combo box (symbols of other ships are also linked).  : Outline  : Minimised Symbol | Outline Minimised Symbol |
| Stern Line | Enable the display of stern line by selecting this item. | To enable: Select. To disable: Clear. |
| Ground stabilised vector (Display of ship speed relative to land) | Enable the display of ship speed relative to land by selecting this item. | To enable: Select. To disable: Clear. |
| Sea stabilised vector (Display of ship speed relative to water) | Enable the display of ship speed relative to water by selecting this item. | To enable: Select. To disable: Clear. |
| Time (own ship vector length) | Enter the time when the ship speed relative to water is displayed in the box. | 1 to 120 min |
| Stabilisation indicator | Selecting this enables to display the stabilisation indicator. Memo Automatically enabled when both the display of ship speed relative to ground and the display of ship speed relative to water are enabled. | To enable: Select. To disable: Clear. |
| Vector Time Mark | Selecting this enables the interval of the vector time mark. | To enable: Select. To disable: Clear. |
| Interval | Select an interval of the vector time mark from the pulldown menu when [Vector Time mark] is enabled. | 1 to 6 min |

Shortcuts

Click on any of available shortcuts to display the related dialogue.

| Shortcut | Setup Dialogue |
|-----------------------|---------------------------------------|
| Setting of AIS Filter | [Settings] – [Filter] dialogue |
| Settings of AZ | [Alert] – [New Target Alarm] dialogue |

11.1.2 Setting up the display of own ship's tracks

Configure the settings for own tracks. The own ship's track dialogue comprises the [Display] tab, the [Plot] tab, and the [Clear] tab. Information of own tracks is recorded in the SSD at intervals in accordance with the settings. Information of a maximum of 20,000 points (When the plotter option is available, maximum of 1,000,000 points) are displayed on a chart as own tracks.

[Operation procedure]

Open the own ship's track display setting screen by performing the following menu operations.

[Menu] button → View → Own Track

[Display] tab

The following table shows the description of the item that is set on the [Display] tab.

| Setting Item | Description of Setting | Setting Value |
|-------------------|---|--|
| Own Track Display | Switch the display of own ship's track to On/Off. | On: Displays own ship's track. Off: Hides own ship's track. |

[Plot] tab

The [Plot] tab can be selected only when the [Own Track Display] on the [Display] tab is set to On.

The following table shows the descriptions of the items that are set on the [Plot] tab.

| Setting Item | Description of Setting | Setting Value |
|----------------|---|---|
| Track Type | Set the type of the own ship's track. Only Standard can be selected. | Standard |
| Plot Colour | Set a colour of the own ship's track. This is in conjunction with own symbol colour. | The colour that was selected from [Settings]-[Colour and Brightness]-[Own Symbol / HL /Vector] |
| Plot Interval | Set a plot interval. A time or a range can be used to set the interval. | Off / 3 s / 5 s / 10 s / 30 s / 1 min / 3 min / 5 min / 10 min / 30 min / 60 min / 1 NM / 3 NM / 5 NM / 10 NM / 0.1 NM / 0.2 NM / 0.3 NM / 0.5 NM |
| Time Label | Display/hide a time label interval. | Display: Select / Hide: Clear |
| Plot Interval | Set a time label interval when [Time Label] is selected. | 1 min / 3 min / 5 min / 10 min / 30 min 60 min |
| File Load/Save | Display the dialogue by selecting [Tools] – [File Manager] – [File Load/Save]. | - |

[Clear] tab

The [Clear] tab can be selected only when [Own Track Display] on the [Display] tab is selected.

The following table shows the descriptions of the setting of the [Clear] tab.

| Setting Item | Description of Setting | Setting Value |
|----------------|--|---------------|
| Track Colour | Specify a colour of the own ship's track to be deleted. Only [All] can be selected. | All |
| Clear | Execute the deletion of the tracks of the colour that was specified in Track Colour. | - |
| File Load/Save | Display the dialogue by selecting [Tools] – [File Manager] – [File Load/Save]. | - |

11.1.3 Setting up the display of the past position

Set the display of the past position.

[Operation procedure]

Open the past position display setting screen by performing the following operations.

[Menu] button → View → Past Position

| Setting Item | Description of Setting | Setting Value |
|---------------|---|---|
| Past Position | Select an interval of the past position. When Off is selected, the past position is not displayed. | Off / 0.5 min / 1 min / 2 min / 4 min / 0.1 NM / 0.2 NM / 0.5 NM / 1 NM |

11.1.4 Setting up the display of user map

Set up the display of User Map.

[Operation procedure]

[Menu] button → View → User Map

The descriptions of settings are shown in the table below.

| Setting Item | Description of Setting | Setting Value |
|-------------------|--|---|
| Object Type | Click on the button to specify whether to display or hide the object mark, and select the mark to be displayed. All On: Displays all marks. Individual: Displays selected marks. | All On / Individual Types of selectable marks Mark: Refer to Appendix D.5 "Icon Button List for User Map". Line: Solid Line, Dotted Line, Dashed Line Text: Text |
| Mark/Line Colour | Display/Hide the colour for Mark/Line. Select the colour to be set. | Display: Select Hide: Clear White / Grey / Amber / Magenta / Blue / Cyan / Green / Yellow / Orange / Dark Red |
| Mark Size | Set the mark display size. | 1 (Minimum) /2/3/4/5 (Maximum) |
| Comment Font Size | Set the font size of the comment. | Standard / Small |

11.1.5 Setting up transparency of echo/radar trails

When you select [RADAR] in the classification pane, the [RADAR] dialogue is displayed in the edit pane.

[Operation procedure]

Open the radar setting screen by performing the following menu operations.

[Menu] button → View → RADAR

The descriptions of settings are shown in the table below.

| Setting Item | Description of Setting | Setting Value |
|-----------------------------|--|--|
| Transparency of Echo/Trails | Click on the control on the slider and set up the transparency of echoes/trails. | 0 to 7 0 = Opaque (Nontransparent) 7 = Transparent |

11.1.6 Setting up the display of TT/AIS target

When you select [Target] in the classification pane, the [Target] dialogue is displayed in the edit pane.

Configure the settings for TT/AIS targets.

[Operation procedure]





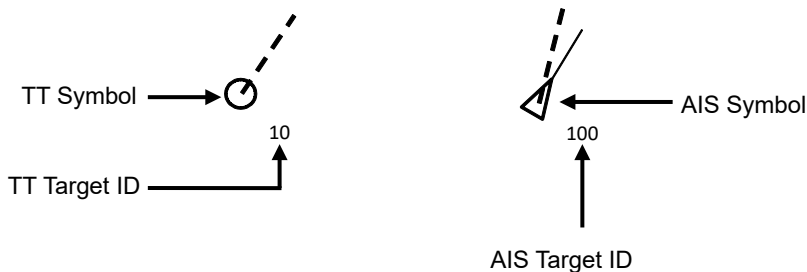



Open the TT/AIS target setting screen by performing the following menu operations.

[Menu] button → View → Target



The descriptions of settings are shown in the table below.

| Setting Item | Description of Setting | Setting Value |
|-------------------------------|---|--|
| CPA Ring (Only Relative mode) | Enable the display of the CPA ring (circle created by using the CPA limit setting range as the radius and own ship as the centre) | To enable: Select. To disable: Clear. |
| AIS Symbol | Selecting this enables to display the AIS symbol. | To enable: Select. To disable: Clear. |
| Physical AtoN | When the AIS symbol is selected and this item is selected, the display of Physical AIS AtoN symbol is enabled. | To enable: Select. To disable: Clear. |
| Virtual AtoN | When the AIS symbol is selected and this item is selected, the display of Virtual AIS AtoN symbol is enabled. | To enable: Select. To disable: Clear. |

| Setting Item | Description of Setting | Setting Value |
|---------------|--|--|
| TT Symbol | Select this item to enable the TT symbol. | To enable: Select. To disable: Clear. |
| TT Target ID | <p>Select a display mode of the TT target ID from the combo box.</p> <p>Off: Hide On: Show TT Track: Displays only the target that shows other ship's track. Ship's Name: When the ship's name has been input in the [TT Target INFO] (property of tracked target) dialogue, that ship name is displayed. If the ship's name has not been input, the identification number is displayed.</p> <p>Display</p> <p> : Off</p> <p> : On</p> <p> : TT Track</p> <p> : Ship's Name</p> | Off / On / TT Track / Ship's Name |
| AIS Target ID | <p>Select a display mode of the AIS target ID from the combo box.</p> <p>Off: Hide On: Show AIS Track: Displays only the target that shows other ship's track (target track). Ship's Name: When the ship's name has been input in the [AIS Target INFO] (property of AIS target) dialogue, that ship name is displayed. If the ship's name has not been input, the identification number is displayed.</p> <p>Display</p> <p> : Off</p> <p> : On</p> <p> : AIS Track</p> <p> : Ship's Name</p> | Off / On / AIS Track / Ship's Name |

11.1.7 Setting up the display of other ship's track

The [Target Track] dialogue consists of the [Display], [Plot] and [Clear] tabs.

[Operation procedure]

Open the other ship's track display setting screen by performing the following menu operations.

[Menu] button → View → Target Track

[Display] tab

On the [Display] tab, set up the display of other ship's tracks.

The descriptions of settings are shown in the table below.

| Setting Item | Description of Setting | Setting Value |
|----------------------|--|--|
| Target Track Display | Select Hide/Display of other ship's track by clicking on the button and set a track to be displayed by selecting the item. All On: Displays all the tracks of other ships. All Off: Hides all the tracks of other ships. Individual: Displays the selected tracks of other ships. | All On / All Off / Individual When Individual is selected: Select from Track1/Track 2 .../Track 10/Track 11 to Track 20/Track 21 to 30/.../Track 91 to 100. |
| File Load/Save | Display the [Tools] – [File Manager] – [File Load/Save] dialogue. | - |

[Plot] tab

The edit pane of the [Plot] tab is divided into two dialogues.

The descriptions of settings are shown in the table below.

| Setting Item | Description of Setting | Setting Value |
|-----------------------------|---|---|
| For All Target Track | Select the radio button, set it to On, and select the colour of the plot of the other ship's track from the combo box. | White / Grey / Amber / Magenta / Blue / Cyan / Green / Yellow / Orange / Dark Red |
| For Individual Target Track | Select the radio button, set it On, and select the colour of the plot of each other ship's track (Track 1, Track 2, ..., Track 10 and Tracks 11 to 20, Tracks 21 to 30, ... Tracks 91 to 100) from the combo box. | White / Grey / Amber / Magenta / Blue / Cyan / Green / Yellow / Orange / Dark Red * The setting value is common among all the combo boxes. |
| Plot Interval | Select a plot interval of target tracks from the combo box. | Off / 3 s / 5 s / 10 s / 30 s / 1 min / 3 min / 5 min / 10 min / 30 min / 60 min / 1 NM / 3 NM / 5 NM / 10 NM / 0.1 NM / 0.2 NM / 0.3 NM / 0.5 NM |
| File Load/Save | Display the [Tools] – [File Manager] – [File Load/Save] dialogue. | - |

[Clear] tab

On the [Clear] tab, clear the other ship's track.

| Setting Item | Description of Setting | Setting Value |
|----------------|---|---|
| Track Colour | By specifying a colour, clear the track. When the [Clear] button is pressed after selecting a colour, a confirmation message dialogue is displayed for clearing the track. To execute Clear, press the [OK] button. | White / Grey / Amber / Magenta / Blue / Cyan / Green / Yellow / Orange / Dark Red |
| Track Number | By specifying a number of other ship's track, clear the track. When other ship's track is selected and the [Clear] button is pressed, a confirmation message is displayed for clearing the track. To execute Clear, press the [OK] button. | Track1 / Track 2 / ... / Track10 / Track 11 to 20 / Track21 to 30 / ... / Track91 to 100 |
| File Load/Save | Display the dialogue by selecting [Tools] – [File manager] – [File Load/Save]. | - |

11.1.8 Setting a chart

When you select [Chart View] in the classification pane, the [Chart View] dialogue is displayed in the edit pane.

[Operation procedure]

Open the chart selection screen by performing the following menu operations.

[Menu] button → View → Chart View

The following table shows the descriptions of the settings.

| Setting Item | Description of Setting | Setting Value |
|----------------------|---|---|
| Chart Type | Select a type of the chart to be displayed by clicking on the button. Displayed only when newpec is installed. C-MAP MAX: Displays the C-MAX chart. newpec: Displays the newpec chart. | C-MAP MAX newpec |
| Display Fishing Area | Displays/hides the fishing area. | Shown: Selected Hidden: Clear |
| Special Line Type | Set up the line type of special line. Off : Hides special lines. Other than Off : Displays special lines in selected type. | Off / Dotted line / Solid line / Dashed line |

11.1.9 Setting up the display of C-MAP MAX

Set drawing of C-MAP MAX.

This setting is allowed only when [C-MAP MAX] is selected in [Chart View].

[Operation procedure]

Open the C-MAP MAX drawing setting screen by performing the following menu operations.

[Menu] button → View → C-MAP MAX

The following table shows the descriptions of the settings.

| Setting Item | Description of Setting | Setting Value |
|----------------------|--|--|
| Page1 | | |
| Mode | Select a water depth shadow mode. The details of a water depth shadow mode are provided in a separate table below. | Off / Normal / Safe / Dynamic / Dynamic Inverted |
| Highlight Depth Area | Set a water depth area fill. On: Fill Off: No fill (white) | On: Selected Off: Clear |
| Minimum Depth | Set a minimum value of the water depth shadow fill range. This item can be set only when [Dynamic] mode or [Dynamic Inverted] mode is selected for the water depth shadow mode. | 0m to Maximum Depth |
| Maximum Depth | Set a maximum value of the water depth shadow fill range. This item can be set only when [Dynamic] mode or [Dynamic Inverted] mode is selected for the water depth shadow mode. | Minimum Depth to 9999 m |
| Safety Contour | Set a safety contour. This item can be set only when [Safe] mode is selected as the water depth shadow mode. | 0m to 9999 m |
| Page2 | | |
| Point of Interested | Display/hide the facility information object. | Shown: Selected Hidden: Clear |
| Land Elevation | Display/hide the land elevation object. | Shown: Selected Hidden: Clear |
| Roads | Display/hide the road object. | Shown: Selected Hidden: Clear |
| Land Elevation Value | Display/hide the land evaluation value. | Shown: Selected Hidden: Clear |
| Land Marks | Display/hide the land mark object. | Shown: Selected Hidden: Clear |
| River & Lake | Display/hide the river and lake object. | Shown: Selected Hidden: Clear |

| Setting Item | Description of Setting | Setting Value |
|--------------------------------|--|----------------------------------|
| Page3 | | |
| Name Tags | Display/hide the name object. | Shown: Selected Hidden: Clear |
| Tides and Currents | Display/hide the tide and current object. | Shown: Selected Hidden: Clear |
| Place Name | Display/hide the place name object. | Shown: Selected Hidden: Clear |
| Seabed Type | Display/hide the seabed symbol object. | Shown: Selected Hidden: Clear |
| Port & Services | Display/hide the port and service object. | Shown: Selected Hidden: Clear |
| Attention Areas | Display/hides the attention sea area object. | Shown: Selected Hidden: Clear |
| Track & Routes | Display/hide the track and route object. | Shown: Selected Hidden: Clear |
| Under Water | Display/hide the object such as reef. | Shown: Selected Hidden: Clear |
| Navigation Aids & Light Sector | Display/hide navigation aid and visible arc/invisible arc objects. | On / Off / No Sector |
| Light Sectors Level | Switch the lighthouse light range level. Specify a degree of details of the C-MAP MAX chart in the order of A to H. A indicates the outline and H indicates the highest detail level. | A / B / C / D / E / F / G / H |

| Setting Item | Description of Setting | Setting Value |
|--------------------------|---|---|
| Page4 | | |
| VAD(Value Added Data) | Display/hide the value added data object. | Shown: Selected Hidden: Clear |
| Chart Boundaries | Display/hide the chart boundaries. To display the chart boundaries, select the check box and select the detail setting from the combo box. | Check box Shown: Selected Hidden: Clear Combo box AUTO/Full |
| Wrecks Depth Label | Display/hide the wreck label. Wreck label: Digit that is displayed next to the wreck object. | Shown: Selected Hidden: Clear |
| Diffusers Depth Label | Display/hide the diffuser label. | Shown: Selected Hidden: Clear |
| Obstructions Depth Label | Display/hide the obstruction label. | Shown: Selected Hidden: Clear |
| Rocks Depth Label | Display/hide the rock label. | Shown: Selected Hidden: Clear |
| Graticule | Display/hide the latitude/longitude lines. | Shown: Selected Hidden: Clear |

Water depth shadow mode

| Mode | Description |
|------------------|--|
| Normal | Display the depth shadow range of the UKHO (United Kingdom Hydrographic Office) accurately. The depth shadow is expressed in three colours (Dark Blue, Light Blue, and White) only. |
| Safe | Although the expression is the same as that of the [Normal] mode, two colours can be used instead of three colours. A safe depth threshold value can be set and the safe depth (depth greater than the threshold value) is expressed in Blue. The colour of safe depth is Green and other depths are expressed in Grey. |
| Dynamic | Express a depth shadow in 32 types of Blue. In [Dynamic] mode, a minimum depth and a maximum depth can be set. Shallows are expressed in a darker shading of Blue. White indicates the depth greater than the maximum depth. |
| Dynamic Inverted | Although the expression is the same as that of the [Dynamic] mode, the depth shadow is expressed by the inverted algorithm. In the same way as the dynamic mode, a minimum depth and a maximum depth can be specified. Shallows are expressed in a lighter shading of Blue and offshore is expressed in darker blue. White indicates the depth shallower than the minimum depth. |

11.1.10 Setting up the display of newpec

Set drawing of newpec.

Display of newpec can be set only when newpec is selected in [Chart View].

[Operation procedure]

Open the newpec drawing setting screen by performing the following menu operations.

[Menu] button → View → newpec

The following table shows the setting descriptions.

[Contour] tab

| Setting Item | Description of Setting | Setting Value |
|------------------|---|--|
| Page1 | | |
| Safety Contour | Set Display/Hide and depth of the safety contour. | Off / 2 m / 5 m / 10 m |
| Contour Display | Display/hide the contour. When this item is selected, the following items are displayed as Enabled, enabling the setting. | Shown: Selected Hidden: Clear |
| Shallow Contour | Set a minimum depth of the contour to be displayed. | 0 to Deep Contour |
| Deep Contour | Set a maximum depth of the contour to be displayed. | Shallow Contour to 9999 |
| Contour Interval | Set a drawing interval of the contour to be displayed. | 1m / 5m / 10m / 20m / 50m / 100m / 200m / 500m / 1000m |
| Line Type | Set a line type of the contour to be displayed. | Solid line / dotted line / dashed line / chain line / two-dot chain line / chain line2 / two-dot chain line2 |
| Colour Mode | Set a colour mode of the contour. Simple Colour: Draws a contour with the specified colour. Standard: Colours according to the depth with the newpec standard colour. | Simple Colour / Standard |
| Colour | Set a colour of the contour to be displayed. This item is displayed only when [Simple Colour] is selected in Colour Mode. | White / Grey / Amber / Magenta / Blue / Cyan / Green / Yellow / Orange / Dark Red / Pale Blue / Green Yellow / Blue Violet / Crimson / Off |

| Setting Item | Description of Setting | Setting Value |
|-----------------------|---|---|
| Page2 | | |
| Highlight Contour | Set a specified contour (contour to be highlighted). Up to nineteen contours can be registered. | - |
| Contour | Specify a water depth of the contour. When a numeric value is entered and the [▼] button is pressed, water depth values that can be set are retrieved and displayed. A contour can be input by selecting a contour on the screen. | 0 to 9999m |
| Add | When this button is clicked on, the water depth value that was specified in the text box is registered in the water depth list. | - |
| Delete | Delete the column that is selected by selecting the check box in the water depth list. | - |
| Contour list | Display the contours of the water depths that are registered in the list. A colour and a line type can be specified for each contour that is displayed. When Off is specified for a colour, the contour will be hidden. | [Colour] White / Grey / Amber / Magenta / Blue / Cyan / Green / Yellow / Orange / Dark Red / Pale Blue / Green Yellow / Blue Violet / Crimson / Off [Line Type] Solid line / dotted line / dashed line / chain line / two-dot chain line chain line2 two-dot chain line2 |
| Contour Value Display | Display/hide the contour value. | Shown: Selected Hidden: Clear |
| Display Priority | Set up a drawing order of the contour. Contour : Draw the contour over the echo. Echo : Draw the contour under the echo. | Contour Echo |

[Chart] tab

| Setting Item | Description of Setting | Setting Value |
|--|--|----------------------------------|
| Name | Display/hide the location name. | Shown: Selected Hidden: Clear |
| Text Size | Set a character size for displaying a location name. This item can be set only when Display is selected for Name. | Large / Small |
| Anchorage Obstruction with Caution | Display/hide Anchorage Obstruction with Caution. | Shown: Selected Hidden: Clear |
| Miscellaneous Boundary | Display/hide facilities and boundaries. | Shown: Selected Hidden: Clear |
| Inshore Light, Ports and Harbors Light | Display/hide inshore lights and port and harbor lights. | Shown: Selected Hidden: Clear |
| Navigation Dangerous Obstruction | Display/hide navigation dangerous obstructions. | Shown: Selected Hidden: Clear |
| Route Boundary | Display/hide route boundaries. | Shown: Selected Hidden: Clear |
| Beacon | Display/hide route beacons. | Shown: Selected Hidden: Clear |
| Anchorage Area | Display/hide anchorage areas. | Shown: Selected Hidden: Clear |
| Landmark | Display/hide landmarks. | Shown: Selected Hidden: Clear |
| Fixed Fishing Net | Display/hide fixed fishing nets. | Shown: Selected Hidden: Clear |
| Graticule | Display/hide latitude/longitude lines. | Shown: Selected Hidden: Clear |
| Sea Fill | Select/clear Sea Fill. | Shown: Selected Hidden: Clear |

11.1.11 Setting up the display of range/bearing measurement function

When you select [Tools] in the classification pane, the [Tools] dialogue is displayed in the edit pane.

[Operation procedure]

Open the [Tools] dialogue by performing the following menu operations.

[Menu] button → View → Tools

The descriptions of settings are shown in the table below.

| Setting Item | Description of Setting | Setting Value |
|------------------------------------|--|---|
| Range Rings (Fixed range rings) | When this item is selected, the range ring display is enabled. | To enable: Select. To disable: Clear. |
| EBL1 | Selecting this enables to display the EBL1/EBL2 markers. | To enable: Select. |
| EBL2 | | To disable: Clear. |
| VRM1 | Selecting this enables to display the VRM1/VRM2 markers. | To enable: Select. |
| VRM2 | | To disable: Clear. |
| PI (Parallel index line) | Enable the display of a parallel index line by selecting the item and select the parallel index line to be displayed by selecting the line. | To enable: Select. To disable: Clear. Selection of parallel index line Index Line1 to 8 |
| Expand Cursor readout & EBL/VRM | Set an expanded display of cursor information and EBL/VRM. On Always expanded for display. On(5s) Expanded for 5 seconds after the operation. Off Not expanded. | On / On(5s) / Off |
| Operating Time on PPI | Display/hide total operating time of display unit and TX time of scanner on PPI. | Shown: Selected Hidden: Clear |

11.1.12 Setting up the display of unit of setting value

Memo

Some items may not be displayed depending on the installation setting.

Set a unit to be displayed for each setting value.

[Operation procedure]

Open the setting screen of unit display by the following menu operations.

[Menu] button → View → Unit

The descriptions of settings are shown in the table below.

| Setting Item | Description of Setting | Setting Value |
|--------------------------|--|-------------------------|
| Depth | Select a unit of the water depth from the combo box. | m / ft / fm |
| Depth (C-MAP MAX) | Select a water depth display unit on the chart from the combo box. | ft / fm / m /decimal fm |
| Current Speed | Select a unit of the current speed from the combo box. | kn / m/s / km/h |
| Wind Speed | Select a unit of the wind speed from the combo box. | kn / m/s / km/h |
| Air TEMP | Select a unit of the air temperature from the combo box. | °C / °F |
| Water TEMP | Select a unit of the water temperature from the combo box. | °C / °F |
| Air Pressure | Select a unit of the air pressure from the combo box. | hPa / mbar |
| Wind Direction (True) | Select a wind direction (true) display method from the combo box. | 16points / Degree |

11.1.13 Setting control of the top screen and menus

When you select [Control] in the classification pane, the [Control] dialogue is displayed in the edit pane.

[Operation procedure]

Open the top screen control setting screen by performing the following menu operations.

[Menu] button → View → Control

Top screen information [Page 1]

Set control of the information that is displayed on the top screen.

| Setting Item | Description of Setting | Setting Value |
|---------------------------------|--|--|
| Show Own Track Control | Selecting this enables to display own track control. | To enable: Select. To disable: Clear. |
| Display Key Operation Number | Display/hide the badge on the target component by menu operations on numeric keys. | Shown: Selected Hidden: Clear |

Menu Display [Page 2]

Set each menu to be displayed or hidden.

This function enables the hiding of menus of low use frequency freely.

1 Set the check box of the target menu to On/Off.

On (selected): Displays on the menu.

Off (cleared): Hides from the menu.

For [View] and [View] – [Control] (this menu) are constantly set to On and cannot be hidden.

Context menu [Page 3]

Set the items on the context menu to be displayed/hidden.

The context menu that is displayed when the right mouse button is clicked on TT/AIS is targeted.

1 Set the target context menu item check box to On/Off.

On (selected): Displays the item on the context menu.

Off (cleared): Hides the item from the context menu.

At the initial setting, all the items are set to On.

Setting a conning block [Page 4]

Set some contents of the conning block to be displayed/hidden.

| Setting Item | Description of Setting | Setting Value |
|---------------------------|--|--|
| Display Order Value | When this item is selected, the indication value display and the indication value bar display are enabled. | To enable: Select. To disable: Clear. |
| MAX | Enter a maximum value of the rudder angle block. | 0 to 180° |
| Display Air Temperature | When this item is selected, air temperature display is enabled. | To enable: Select. To disable: Clear. |
| Display Water Temperature | When this item is selected, water temperature display is enabled. | To enable: Select. To disable: Clear. |
| Display Air Pressure | When this item is selected, air pressure display is enabled. | To enable: Select. To disable: Clear. |
| Display Humidity | When this item is selected, humidity display is enabled. | To enable: Select. To disable: Clear. |

11.1.14 Setting up the display of depth graph

When [Depth Graph] is selected in the classification pane, the “Depth Graph” dialogue is displayed in the editing pane.

[Operation procedure]

Open the “Depth Graph” dialogue by using the following procedure.

[Menu] button → View → Depth Graph

The setting contents are shown in the following table.

| Setting item | Description of setting | Setting value |
|--------------|--|---|
| Depth Range | Select a depth range of the depth graph. | AUTO / 50m / 100m / 250m |
| Time Range | Select a time range of the depth graph. | 10min / 15min / 30min / 60min / 12hours |
| Reference | Select a reference of the depth. | AUTO / Keel |

11.1.15 Setting up the display of water temperature graph

When [Water TEMP Graph] is selected in the classification pane, the “Water TEMP Graph” dialogue is displayed in the editing pane.

[Operation procedure]

Open the “Water TEMP Graph” dialogue by using the following procedure.

[Menu] button → View → Water TEMP Graph

The setting contents are shown in the following table.

| Setting item | Description of setting | Setting value |
|--------------|---|---|
| Graph Colour | Select a colour of the water temperature graph. | Grey / Blue / Cyan / Green / Yellow / Orange / Dark Red |
| Time Range | Select a time range of the water temperature graph. | 10min / 15min / 30min / 60min / 12hours |



Section 12 Setting up Alerts

By setting this equipment to generate an alert when the own ship's position or the condition meets the specific condition or any other ship or obstacle approaches to a specific range, preliminary measures can be taken, avoiding collisions, grounding, and deviation from the route.

This section explains the method of setting conditions (threshold values) for generating alerts, alert processing operations, and alert timer setting using the [Alert] menu.

12.1 Selecting Setting Items

The following items can be set in the [Alert] dialogue box.

| Memo Some items may not be displayed depending on the installation setting. | |
|---|---|
| Setting item | Setting contents |
| Collision Avoidance | Set the following conditions to generate a collision avoidance alert. <ul style="list-style-type: none">• CPA/TCPA limit value• Status of the AIS/TT target to be targeted for a lost alert Refer to "12.2 Collision Avoidance Alert Generation Conditions". |
| New Target Warning (Target acquisition warning) | Set the following conditions to generate an automatic acquisition target warning <ul style="list-style-type: none">• Area (AZ) for TT target automatic acquisition• Enable/disable AZ Refer to "12.3 New Target Warning Generation Conditions". |
| Depth (Water depth) | Set the following conditions to generate a grounding avoidance alert. <ul style="list-style-type: none">• Below keel water depth alarm Refer to "12.4 Depth Alert Issuing Conditions". |
| RADAR Alarm | Set the following conditions to issue a radar alarm. <ul style="list-style-type: none">• Sector alarm Refer to "12.5 RADAR Alarm Issuing Conditions". |
| Position Integrity | Set the conditions for issuing a Position monitor and a HDOP Limit caution. Refer to "12.6 Position Integrity Alert Generation Conditions". |
| AMS (Alert Management System) | Set the actions to be taken at the next stage for an unacknowledged alert. Refer to "12.7 Setting up Alert Processing". |

12.2 Collision Avoidance Alert Generation Conditions

[Operation procedure]

Open the [Collision Avoidance] dialogue by performing the following menu operations.

[Menu] button → Alert → Collision Avoidance

In this dialogue, the collision detection condition (CPA/TCPA limit) and the AIS target status, which is the target of alert detection, can be set.

For the details of CPA/TCPA, refer to "6.2 Collision Avoidance Issue (Explanation)".

Memo

As for the values of collision detection conditions, please specify the optimal values according to the ship type, sea area, weather and marine conditions. (For the condition and type of each alert, refer to "6.7 Alert Display".)

12.2.1 Setting the CPA/TCPA limit values

- 1 Enter the value of [CPA Limit] in a range from 0.1 NM to 9.9 NM.
- 2 Enter the value of [TCPA Limit] in a range from 1 min to 99 min.

12.2.2 Setting the status of the AIS/TT target that is targeted for lost warning

- 1 Select a target for detecting a lost warning of the AIS/TT target from the [Lost Warning] combo box.

TT & Activated AIS: Tracking inner TT targets excluding initial acquisition targets and activated AIS targets (including danger targets and numeric value display targets) are included.

Danger : Danger targets are included.

Off : Lost warnings are not generated.

Memo

- Lost warnings for sleeping AIS targets will not be generated.
- The following message is displayed in the alert status area when [Off] is set.
Lost Alert is Disabled

- 2 Setting a target for detection limit of the AIS/TT target from the [Lost Detection Limit] input box

- 3 Select a target for detecting a CPA/TCPA alarm of the AIS target from the [AIS CPA/TCPA Alarm] combo box.

ACT & Sleep : Activated AIS targets and sleeping AIS targets are included.

ACT : Activated AIS targets are included.

Off : CPA/TCPA alarms are not generated.

12.3 New Target Warning Generation Conditions

[Operation procedure]

Open the [New Target Warning] dialogue by performing the following menu operations.

[Menu] button → Alert → New Target Warning

In this dialogue, it is possible to set the AZ (automatic acquisition/activation zone) and switch the AZ to enable/disable.

For the details of the setting of the AZ, refer to "6.5.1.1 Automatic acquisition (automatic acquisition) mode".

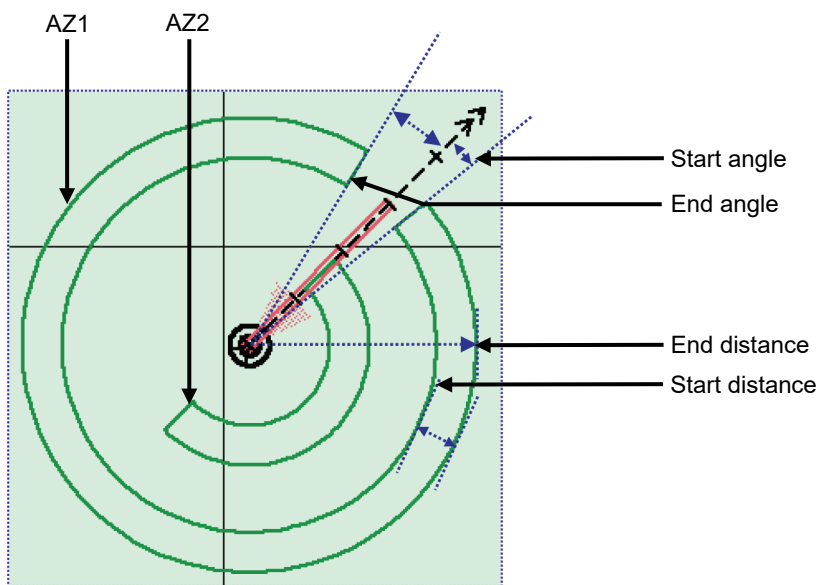

12.3.1 Switching AZ1/AZ2 to enable/disable

12.3.1.1 Enabling AZ1 or AZ2

Select the [Use AZ1] or [Use AZ2] check box.

A TT target / AIS target in the applicable AZ is automatically acquired / activated and it becomes a target of collision detection.

A "  " mark and identification number are assigned to the acquired TT target on the radar screen, which are moved together with the TT target, and then a vector is displayed within 1 min.

12.3.1.2 Disabling AZ1 or AZ2

Clear the [Use AZ1] or [Use AZ2] check box.

Acquired and activated zones disappear from the RADAR screen. However, already acquired TT targets are continuously tracked. Moreover, activated AIS targets remain activated.

12.4 Depth Alert Issuing Conditions

[Operation procedure]

Open the [Depth] dialogue by performing the following menu operations.

[Menu] button → Alert → Depth

In this dialogue, a threshold value for issuing [Depth Below Keel alarm] can be set.

A [Depth Below Keel] threshold value can be set within the range from 0 m to 200 m.

12.5 RADAR Alarm Issuing Conditions

[Operation procedure]

Open the RADAR Alarm issuing condition setting screen by performing the following menu operations.

[Menu] button → Alert → RADAR Alarm

In this dialogue, set a RADAR Alarm issuing range.

The following table shows the setting items.

| Setting item | Description of setting | Setting value |
|------------------|---|----------------------------|
| RADAR Alarm Mode | Set a condition for issuing an alarm. In: A "RADAR Alarm (In)" alarm is issued while a target (echo) exists within the alarm range. Out: A "RADAR Alarm (Out)" is issued while a target (echo) exists outside of the alarm range. | In / Out |
| Detection Level | Set a signal level of the radar echo that is recognised as a target. | 1 (Low) / 2 / 3 / 4 (High) |

[Sector] tab

Set a Sector alarm issuing range.

| Setting item | Description of setting | Setting value |
|-------------------------------|---|--------------------------|
| 1/2 tab | A sector to be set can be selected from Sector 1 or Sector 2. | 1 / 2 |
| Use Sector 1 / Use Sector 2 | Set a sector alert to On/Off. When this item is set to Off, the Sector is hidden. | On: Select Off: Clear |
| Make Sector 1 / Make Sector 2 | The cursor mode is set to a sector creation mode. When the [Make Sector] button is pressed and the [Use Sector 1 / Use Sector 2] check box is Off, the item is set to On automatically. | - |
| Start Angle | Set a sector start angle. | 000.0° to 359.9° |
| End Angle | Set a sector end angle. | 000.0° to 359.9° |
| Start Distance | Set a sector start distance. | 0.10 NM to 31.50 NM |
| End Distance | Set a sector end distance. A sector end distance can be set under the conditions where the distance width from the start distance is within the range from 0.50 NM to 2.00 NM. | 0.60 NM to 32.00 NM |

[Polygon] tab

Set a polygon alarm issuing range.

This function cannot be used now.

12.6 Position Integrity Alert Generation Conditions

[Operation procedure]

Open the [Position Integrity] dialogue by performing the following menu operations.

[Menu] button → Alert → Position Integrity

In this dialogue, [Position monitor] issuing conditions and [HDOP Limit] can be set.

12.6.1 Setting up the generation condition of the Position monitor

Enter the following threshold value for issuing a position monitor.

Position Difference Limit:

The difference in distances when two GPS positions are compared at every second is used as a threshold value. Specify the difference in a range between 0.010 and 9.990 NM.

Memo

[Position Difference Limit] functions when two GPS systems are installed.

Radius Limit (GPS):

The radius of a monitoring circle having the predicted position of a GPS 1 sec later at the centre is used as a threshold value. If the position actually measured is not within the time monitoring circle specified in [Time Limit], it will be subjected to an alert. Specify the radius limit in a range between 10 and 100 m.

Radius Limit (DGPS):

The radius of a monitoring circle having the predicted position of DGPS 1 sec later at the centre is used as a threshold value. If the position actually measured is not within the time monitoring circle specified in [Time Limit], it will be subjected to an alert. Specify the radius limit in a range between 10 and 100 m.

Time Limit:

The time during which the position actually measured by a GPS/DGPS deviates from the monitoring circle is used as a threshold value. The time limit can be specified in a range between 1 and 29 s.

12.6.2 Setting up the HDOP exceeded generation condition

Select HDOP threshold limit value in the [HDOP exceeded] combo box.

Select either one of [4], [10] and [20].

12.7 Setting up Alert Processing

[Operation procedure]

Open the [AMS] dialogue by performing the following menu operations.

[Menu] button → Alert → AMS

In this dialogue, the time to activate the action at the next stage when acknowledge is not performed for an alert can be set up.

Enter a wait time up to the issuing of an alert of the next stage in each [Time Limit].

[Reactivation of Silenced Alert]–[Time Limit]:

The time required to reactivate the alert sound that was silenced temporarily. It is fixed for 30 seconds.

[Transfer to BNWAS]–[Time Limit]:

When a BNWAS (Bridge Navigational Watch Alarm System) is connected, specify the time to transfer an unacknowledged alert to the BNWAS in a range between 0 and 60 s.

[Repetition of UNACK Warning]–[Time Limit]:

Specify the time to regenerate an unacknowledged warning as an alert sound in a range between 16 and 300 s. A warning will be generated repeatedly until it is acknowledged.

Section 13 Setting up the Operation Mode

13.1 Basic Operation of the [Settings] Dialogue

You can set up the operation mode in the [Settings] dialogue.

Classification pane display targets

The table below provides the classification panes that are displayed and the related sections.

| Classification pane | Related section |
|-----------------------|---|
| Signal Process | 13.2 Setting Radar Signal Processing |
| Obs. Scene Preset | 13.3 Presetting Each Observation Scene |
| Obs. Scene Common | 13.4 Observation Scene Common Settings |
| Trails | 13.5 Setting Other Ship's Radar Trails |
| Trails Masking | 13.6 Setting Radar Trail Mask |
| TXRX | 13.7 Setting Radar Antennas |
| Association | 13.8 Setting Associations |
| Ship's Dynamic Trait | 13.9 Setting Own Ship's Dynamic Trait |
| Preset of Same Fleet | 13.10 Setting Consort Ship Preset |
| TT Test | 13.11 Setting Operation Tests |
| Filter | 13.12 Setting AIS Filters |
| Target Track | 13.13 Setting the Target Track Function to ON/OFF |
| NAVTEX | 13.14 Setting NAVTEX |
| Event Mark | 13.15 Setting an Event Mark |
| Geodetic | 13.16 Setting Datum Conversion |
| General | 13.17 Setting Navigation Equipment |
| GPS | 13.18 Setting GPS |
| DGPS | 13.19 Setting DGPS |
| SBAS | 13.20 Setting SBAS |
| Cursor, EBL/VRM | 13.21 Setting Cursor, EBL/VRM |
| Colour and Brightness | 13.22 Setting Colours and Brightness |
| Sounds | 13.23 Setting Sounds |
| Key Assignment | 13.24 Setting Key Assignment |
| Preferences | 13.25 Setting Preferences Information |
| Screen Capture | 13.26 Setting Screen Capture |

13.2 Setting Radar Signal Processing

Set various processing methods of radar signals.

[Operation procedure]

Open the radar signal processing setting screen by performing the following menu operations.

[Menu] button → Settings → Signal Process

| Setting Item | Description of Setting | Setting Value |
|----------------------------|---|---|
| Video Latitude | Set up the gradation of the radar video. | Narrow / Normal / Wide / Super Wide |
| Video Noise Rejection | Set up to remove noise and signals which are considered to be clutters of radar video. | Off / Level1 (Low)/ Level2 (High) |
| AUTO Dynamic Range Control | When this is selected, the dynamic range is automatically adjusted. | To enable: Select. To disable: Clear. |
| Process Switch | Specify a particular area and set up a mode for performing video processing on the inside and outside of the particular area. | Off / Range Fix / AUTO |
| 2nd Process Mode | Set up a processing mode used in the outside of the particular area. This item is enabled when an option other than [Off] is selected in the [Process Switch] combo box. | PROC Off 3Scan CORREL 4Scan CORREL 5Scan CORREL Remain Peak Hold Bird |
| Process Switch Range | Set up the boundary range of a particular area. This item is enabled when [Range Fix] is selected in the [Process Switch] combo box. | 0.1 to 25.5 NM |
| Fast Target Detection | When this item is enabled, high-speed moving targets that are suppressed by the scan correlation processing can be detected more easily. | To enable: Select. To disable: Clear. |
| SART | If it is enabled, the Radar Transponder (SART: Search and Rescue Radar Transponder) screen can be displayed. This item is valid on the RADAR screen only. | To enable: Select. To disable: Clear. |

13.3 Presetting Each Observation Scene

CAUTION



Adjust the preset of the observation scene according to the oceanographic condition, with the thorough understanding of the features of the radar signal processing setting. The optimum radar performance may not be able to be demonstrated due to the contents of the changed setting or the oceanographic condition at that time.

There are 12 types of observation scenes; you can preset each observation scene.

The items that can be preset are displayed in the editing pane by being divided into six setup dialogues.

[Operation procedure]

Open the observation scene preset screen by performing the following menu operations.

[Menu] button → Settings → Obs. Scene Preset

The following table shows the items that are displayed for each dialogue.

Memo

Some items may not be displayed depending on the installation setting.

Common

| Setting Item | Description of Setting | Setting Value |
|--------------|-------------------------------|--|
| Obs. Scene | Set up the observation scene. | Standard / Coast / Open-Sea / Fishnet / Storm / Calm / Rain / Bird / Long / Buoy / User1 / User2 |

Page 1

| Setting Item | Description of Setting | Setting Value |
|------------------------------------|--|---|
| IR (Interference Rejection) | Set up the IR (Interference Rejection) function. | IR Off / IR Low / IR Middle / IR High |
| Target Enhance | Set up the Target Enhance function. | ENH Off / ENH Level1 / ENH Level2 / ENH Level3 |
| Echo Process | Set up the Echo Process function. If the ship's heading cannot be acquired, [PROC Off] is set. | PROC Off 3Scan CORREL 4Scan CORREL 5Scan CORREL Remain Peak Hold |
| Sea (sea clutter adjustment) | You can switch between MAN and AUTO. MAN: Manually removes sea clutters. AUTO: Automatically removes sea clutters. | MAN / AUTO |

| Setting Item | Description of Setting | Setting Value |
|--|--|--------------------------|
| Rain (rain/snow clutter adjustment) | You can switch between MAN and AUTO. MAN: Manually removes rain/snow clutters. AUTO: Automatically removes rain/snow clutters. | MAN / AUTO |
| AUTO Change H-UP | Set whether the PPI bearing mode is to be changed when the observation scene is changed. On: The bearing mode is changed to H-UP automatically when the observation scene is changed. Off: The bearing mode is not changed even if the observation scene is changed. | On: Select Off: Clear |

Page 2

| Setting Item | Description of Setting | Setting value (by antenna) | | | | | |
|-----------------------|--|----------------------------|-------------------|---------------------------------|--|---------------------------------|---------------------------------|
| | | 4 kW | 6 kW | 10 kW | 25 kW | 30 kW | Solid state |
| 0.75 (0.75 to 1.5) NM | Select a pulse width of 0.75 NM range. | SP1 MP1 | SP1 MP1 | SP1 MP1 | SP1 MP1 | SP1 MP1 | SP1 MP1 |
| 1.5 (1.5 to 3) NM | Select a pulse width of 1.5 NM range. | SP1 MP1 MP2 | SP1 MP1 MP2 | SP1 MP1 MP2 | SP1 MP1 MP2 MP3 | SP1 MP1 MP2 MP3 | SP1 MP1 MP2 |
| 3 (3 to 6) NM | Select a pulse width of 3 NM range. | SP1 MP1 MP2 | SP1 MP1 MP2 | SP1 MP1 MP2 LP1 | SP1 MP1 MP2 MP3 LP1 | MP1 MP2 MP3 LP1 | SP1 MP1 MP2 LP1 LP2 |
| 6 (6 to 12) NM | Select a pulse width of 6 NM range. | MP1 MP2 LP1 | MP1 MP2 LP1 | SP1 MP1 MP2 LP1 LP2 | SP1 MP1 MP2 MP3 LP1 LP2 | MP1 MP2 MP3 LP1 LP2 | MP1 MP2 LP1 LP2 |
| 12 (12 to 16) NM | Select a pulse width of 12 NM range. | MP1 MP2 LP1 | MP1 MP2 LP1 | SP1 MP1 MP2 LP1 LP2 | SP1 MP1 MP2 MP3 LP1 LP2 | MP1 MP2 MP3 LP1 LP2 | MP2 LP1 LP2 |
| 16 (16 to 22)NM | Select a pulse width of 16 NM range. | MP1 MP2 LP1 | MP1 MP2 LP1 | MP1 MP2 LP1 LP2 | MP1 MP2 MP3 LP1 LP2 | MP1 MP2 MP3 LP1 LP2 | LP1 LP2 |

| Setting Item | Description of Setting | Setting Value |
|----------------------------|--|---|
| Video Latitude | Set up the radar image. | Narrow / Normal / Wide / Super Wide |
| Video Noise Rejection | Set up to remove noise and signals which are considered to be clutters of radar images. | Off / Level1 (Low) / Level2 (High) |
| AUTO Dynamic Range Control | When this is selected, the dynamic range is automatically adjusted. | To enable: Select To disable: Clear |
| Process Switch | Specify an area and set up a mode for performing video processing on the inside and outside of the area. | Off / Range Fix / AUTO |
| 2nd Process Mode | Set up a processing mode used in the outside of the area. The setting is enabled when an option other than [Off] is selected in the [Process Switch] combo box. | PROC Off 3Scan CORREL 4Scan CORREL 5Scan CORREL Remain Peak Hold Bird |
| Process Switch Range | Set up the boundary range of a particular area. The setting is enabled when [Range Fix] is selected in the [Process Switch] combo box. | 0.1 to 25.5 NM |
| Fast Target Detection | When this item is enabled, high-speed moving targets that are suppressed by the scan correlation processing can be displayed more easily. The setting is enabled when [2nd Process Mode] is within the range of [3Scan CORREL] to [5Scan CORREL]. | To enable: Select. To disable: Clear. |

| Setting Item | Description of Setting | Setting Value |
|--------------------------------------|--|--|
| Trails Mode | Select a radar trail display mode. | True / Relative |
| Trails Ref Level | Set an image level required to draw radar trails. The higher the level is, the higher the threshold value for drawing radar trails becomes. | Level1 (Low) Level2 Level3 Level4 (High) |
| Trails Reduction | Set a radar trail thinning processing level. The higher the level is, the stronger the effect of the thinning processing level becomes. | Off Level1 (Wide) Level2 Level3 (Narrow) |
| Use MAX Length Preset (Check box) | By selecting/clearing the check box, the using/not using of the setting at the change of the observation scene is determined. When the check box is selected, select the maximum value of the time for displaying the radar trails from the combo box. | Short / Middle / Long |
| Maximum length selection (Combo box) | | |
| Trails Length | Set up the interval for displaying radar trails. | <Setting [Short]> Off / 15 s / 30 s / 1 min / 3 min / 6 min / 10 min / 15 min / 30 min / 60 min <setting [Long]> Off / 30 min / 1 hour / 2 hour / ... (subsequently, 1-hour units) ... 24 hour |
| Use Vector Length Preset (Check box) | By selecting/clearing the check box, the using/not using of the setting at the change of the observation scene is determined. When this check box is selected, set a vector length to be assigned to the observation scene. | 1 to 120 min |
| Vector length input (Text box) | | |

Page 5

| Setting Item | Description of Setting | Setting Value |
|-------------------|--|---|
| Gain Offset | Set up the gain offset for sensitivity compensation. | -32 to 32 |
| PRF | Set up the operation mode of the transmitter's repetition transmission frequency. [Economy] cannot be selected when a solid state radar antenna is connected. If a solid state radar antenna is connected while [Economy] is being selected, the setting will be reset to the default (factory preset) value. | Normal / Economy / High Power |
| Fishnet Detection | Turn On/Off the fishnet detection mode. | To enable: Select. To disable: Clear. |
| Antenna Height | Set up the radar antenna height. When this is set to [Default], the value that has been set in [Antenna Height] by selecting [Service] - [Adjustment] - [TXRX] is used. | Default / -5 m / 5-10 m / 10-20 m / 20 m- |

Page 6

| Setting Item | Description of Setting | Setting Value |
|-----------------------|--|---------------|
| Save as User Settings | Data that can be called is saved as the user default values of the selected observation scene. | - |
| Load User Settings | Load the user default values to the data that can be called. | - |
| Initialise | Load the data that is set at the factory shipment to the data that can be loaded. | - |

13.4 Observation Scene Common Settings

Set observation scenes to be assigned to any of the short range, middle range, and long range.

[Operation procedure]

Open the observation scene common setting screen by performing the following menu operations.

[Menu] button → Settings → Obs. Scene Common

| Setting Item | Description of Setting | Setting Value |
|---------------------|---|--|
| Short (Short range) | Select a range of observation scene "AUTO(S)". A range shorter than MID (middle range) and Long (long range) can be set. | 0.125 to 48.000 NM *The maximum value is less than the range that is set in MID. |
| MID (Middle range) | Select a range of observation scene "AUTO(M)". A range longer than Short (short range) and shorter than Long (long range) can be set. | 0.250 to 96.000 NM *The minimum value is greater than the range that is set in Short. |
| Long (Long range) | Display the range of observation scene "AUTO(L)". The value that was set in the middle range is displayed. | - |
| Obs. Scene - Short | Select an observation scene to be set in observation scene "AUTO(S)". | Standard / Coast / Open-Sea / Fishnet / Storm / Calm / Rain / Bird / Long / Buoy / User1 / User2 |
| Obs. Scene - MID | Select an observation scene to be set in observation scene "AUTO(M)". | Same as above |
| Obs. Scene - Long | Select an observation scene to be set in observation scene "AUTO(L)". | Same as above |
| Show Obs. Scene | Select an observation scene to display on the screen. Checking the checkbox of the Obs. Scene to be used. [Standard] is constantly set to On and cannot change. [AUTO] is set to Off, setting of [AUTO change Obs. Scene] is disabled. | |

13.5 Setting Other Ship's Radar Trails

Set other ship's radar trails.

[Operation procedure]

Display the radar trail setting screen by performing the following menu operations.

[Menu] button → Settings → Trails

The following table shows the setting items.

| Setting Item | Description of Setting | Setting Value |
|------------------|--|--|
| Trails Mode | Select a radar trail display mode. | True / Relative |
| Trails Ref Level | Set up a video level required to draw radar trails. The higher the level gets, the higher the threshold value for drawing radar trails becomes. | Level1 (Low) Level2 Level3 Level4 (High) |
| Trails Reduction | Set up the radar trail reduction processing level. The higher the level gets, the stronger the reduction processing level becomes. | Off Level 1 (Wide) Level2 Level3 (Narrow) |
| MAX Length | Select the maximum value of the time to display radar trails. | Short / Long |

13.6 Setting Radar Trail Mask

Radar trail mask

If radar trails of unnecessary targets are not drawn on the radar trail of target you want to focus on, you can leave the radar trail you want to pay attention to. By specifying a target, that radar trail will be masked and will not be drawn.

The target that can mask the radar trail is up to four tracking targets and the associated AIS targets. If an unassociated AIS target is specified, acquire the target and mask the radar trail. If a sleeping AIS target is specified, activate and acquire the target and mask the radar trail.

Memo

The following targets can not be associated, so they are not targeted for the radar trail mask.

- AIS AtoN
- AIS SAR aircraft
- AIS coastal base station
- Initial acquisition target
- External TT

The area of radar trail mask can be displayed and extended. However, if the mask area is excessively extended, a radar trail of target passing nearby is not drawn.

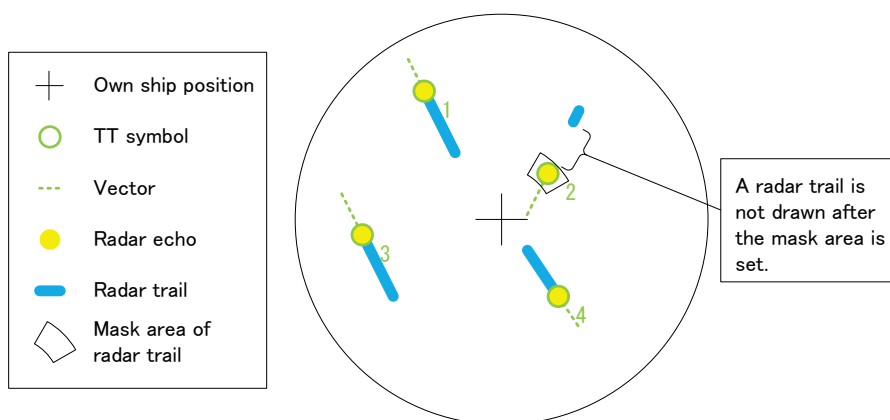

Set a radar trail mask function.

[Operation procedure]

Open the radar trail mask setting screen by performing the following menu operations.

[Menu] button → Settings → Trails Masking

The following table shows the setting items.

| Setting Item | Description of Setting | Setting Value |
|--------------------------|---|--------------------------------------|
| Show Trails Masking Area | Display/hide radar trail mask. | To display: Select To hide: Clear |
| Expand Masking Size | Specify a size for expanding the trail mask area. When the [Def.] button is pressed, the expansion size is reset to the initial value. | Specify from 5 levels. |

Specify a radar trail mask of target

- 1 Right-click a target. The context menu is displayed.**
- 2 Select [Mask trails] in the context menu.**
- 3 Specify the number of mask from 1 to 4. The radar trail of specified target is masked.**

Cancel a radar trail mask of target

- 1 Right-click a target. The context menu is displayed.**
- 2 Select [Mask trails] in the context menu.**
- 3 Select the ID of target to cancel. The radar trail mask of selected target is canceled.**

13.7 Setting Radar Antennas

Set radar antennas.

[Operation procedure]

Open the antenna setting screen by performing the following menu operations.

[Menu] button → Settings → TXRX

| Setting Item | Description of Setting | Setting Value |
|------------------------|--|--|
| PRF Fine Tuning | You can reduce the setting value of the repetition transmission frequency by 0.2% (maximum value is 0). | 0 to 31 |
| Stagger Trigger | Select On/Off of the Radio Wave Interference Reduction function. It is not displayed when a solid state radar antenna is connected. The previous setting value is maintained, however. | To enable: Select. To disable: Clear. |
| PRF | Set up the operation mode of the transmitter's repetition transmission frequency. [Economy] is not displayed when a solid state radar antenna is connected. If a solid state radar antenna is connected while an operation mode is being specified, the setting will be reset to the default value. | Normal / Economy / High Power |
| Ice Class Standby Mode | Turn On/Off the Ice Class Standby mode. | To enable: Select. To disable: Clear. |

Memo

- If a small solid state radar antenna is connected, the setting in [Stagger Trigger] will not be saved and it will turn On (its check box is already selected) at each startup.
- When a new antenna (NKE-2255) is connected, the [REF] combo box is not displayed.

13.8 Setting Associations

Set TT/AIS.

[Operation procedure]

Open the TT/AIS setting screen by performing the following menu operations.

[Menu] button → Settings → Association

The AIS target and the tracking target are checked if they are identical and if so, an association symbol is displayed for the targets. In this case, the AIS target symbol is automatically activated.

Memo

If you don't want to perform an identical target judgement, or if you want to display hidden symbols, turn the association setting to Off.

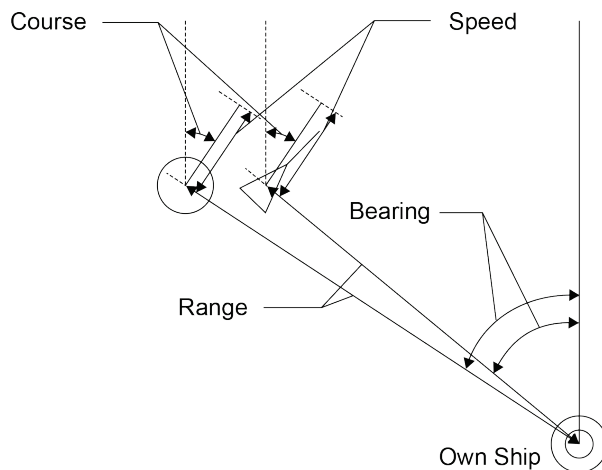

| Setting Item | Description of Setting | Setting Value |
|-----------------------|---|--|
| Association | Turn On/Off the association setting. | To enable: Select. To disable: Clear. |
| Priority | Select a priority of association target display. | AIS / TT |
| Bearing | Set up the bearing difference of the association target. | 0.0 to 9.9° |
| Range | Set up the range difference of the association target. | 0 to 999 m |
| Course | Set up the course difference of the association target. | 0 to 99° |
| Speed | Set up the speed difference of the association target. | 0 to 99.9 kn |
| Applicable AIS Target | Select a state of the AIS which will be an association target. Only the AIS target you specified will be an association target. | ACT / ACT & Sleep |

13.9 Setting Own Ship's Dynamic Trait

Set dynamic traits of own ship.

[Operation procedure]

Open the own ship's dynamic trait setting screen by performing the following menu operations.

[Menu] button → Settings → Ship's Dynamic Trait

| Setting Item | Description of Setting | Setting Value |
|--------------|--|---------------------|
| Reach | Set up the distance to reach the turn. | 0 to 2000 m |
| Turn Mode | Set up the Turn mode. | Radius / Rate |
| Radius | Enter the radius of the turn rate. This item is displayed when [Radius] is selected in the [Turn Mode] combo box. | 0.10 to 2.00 NM |
| Rate | Enter the speed of the turn rate. This item is displayed when [Rate] is selected in the [Turn Mode] combo box. | 20 to 720°/min |
| Acceleration | Enter the rate of change of speed (acceleration) of own ship's dynamic trait. | 0.0 to 100.0 kn/mir |
| Deceleration | Enter the rate of change of speed (deceleration) of own ship's dynamic trait. | 0.0 to 100.0 kn/mir |

13.10 Setting Consort Ship Preset

Specify a consort ship (accompany ship).

[Operation procedure]

Open the consort ship preset setting screen by performing the following menu operations.

[Menu] button → Settings → Preset of Same Fleet

[TT] tab

| Setting Item | Description of Setting |
|--------------|---|
| No. | Display the consort ship number. The consort ship number is between 1 and 20. |
| Target ID | Specify a Target ID of the TT that is specified as the consort ship. When the TT option is available, ID between 1 and 100 can be specified and when the TT option is not available, ID between 1 and 30 can be specified. |
| Delete | Delete the Target ID of the selected consort ship number. Target ID to be deleted can be selected by using the check box next to the number. |

[AIS] tab

| Setting Item | Description of Setting |
|--------------|--|
| No. | Display the consort ship number. The consort ship number is between 1 and 20. |
| MMSI | Specify MMSI that is specified for the consort ship. |
| Delete | Delete the Target ID of the selected consort ship number. MMSI to be deleted can be selected by using the check box next to the number. |

13.11 Setting Operation Tests

Set information on operation tests.

[Operation procedure]

Open the operation test setting screen by performing the following menu operations.

[Menu] button → Settings → TT Test

| Setting Item | Description of Setting | Setting Value |
|------------------------|--|---|
| Test Video | Set up the type of test video. | Off / VDIN |
| TT Simulator | Set up the scenario of the TT Simulator mode. | Off / Scenario1 / Scenario 2 / Scenario 3 / Scenario 4 / Scenario 5 / Scenario 6 |
| Gate Display | Switch between On/Off of the Gate Display mode. | To enable: Select. To disable: Clear. |
| Vector Constant | Set up the vector's tracking performance. | 1 to 8 |
| VD Level Mode (Manual) | Display the threshold value display method of the quantization mode at manual acquisition. | AUTO Threshold1 AUTO Threshold 2 Manual Threshold |
| VD Level (Manual) | Set up the quantization level when acquiring manually. | 0 to 255 |
| VD Level (AUTO) | Set up the quantization level when acquiring automatically. | 0 to 255 |
| Gate Size | Display the gate size to be used for tracking. | Small / Medium / Large |
| Tracking | The number of currently acquired targets is displayed in a range from 0 to the maximum TT display count. | - |

13.12 Setting AIS Filters

Set information on AIS filters.

By setting an AIS filter, the AIS target within the area can be displayed preferentially or only the inside of the area can be displayed.

[Operation procedure]

Open the filter setting screen by performing the following menu operations.

[Menu] button → Settings → Filter

| Setting Item | Description of Setting | Setting Value |
|----------------|--|--|
| Sector Filter | When this item is enabled, Sector Filter is displayed on the screen and filtering is performed in the operation mode that is selected in [Filtering Mode]. | To enable: Select. To disable: Clear. |
| Start Angle | Set up the starting angle of the Sector Filter. The angle value indicates the relative bearing based on the ship's heading as the reference. When entry is confirmed, the entered value takes effect immediately. | 0.0 to 359.9° |
| End Angle | Set up the end angle of the Sector Filter. The angle value indicates the relative bearing based on the ship's heading as the reference. When entry is confirmed, the entered value takes effect immediately. | 0.0 to 359.9° |
| Ring Filter | When this item is enabled, Ring Filter is displayed on the dialogue and filtering is performed in the operation mode that is selected in [Filtering Mode]. | To enable: Select. To disable: Clear. |
| Distance | Set up the distance of the Ring Filter. When entry is confirmed, the entered value takes effect immediately. | 0.0 to 120.0 NM |
| Filtering Mode | Select an operation mode of the AIS filter. Display: AIS targets cannot be displayed outside of the AIS filter range. Priority: Priority is determined within the range of the AIS filter and AIS targets are displayed based on the priority. | Display / Priority |

Creating a filter in the dialogue

Creating a Sector Filter

1 Click on the [Sector] tab.

2 Click on [Make AIS Filter].

The button is highlighted and the cursor mode is set to the Make AIS Filter mode.

3 Move the cursor to the start angle of the sector filter to be set and click the mouse button.

A start angle can be directly input by selecting the [Start Angle] text box.

4 Move the cursor to the end angle of the sector filter to be set and click the mouse button.

An end angle can be directly input by selecting the [End Angle] text box.

Creating a Ring Filter

- 1** Click on the [Ring] tab.
- 2** Click on [Make AIS Filter].
The button is highlighted and the cursor mode is set to the Make AIS Filter mode.
- 3** Move the cursor, place it on the distance of the Ring filter you want to set up, and then click on it.
A distance can also be directly input by selecting the [Distance] text box.

Memo

When the AZ function is set to ON, a distance smaller than the outer arc of AZ cannot be set for the Ring Filter.

13.13 Setting the Target Track Function to ON/OFF

Enable/Disable the other ship's track function.

[Operation procedure]

Open the other ship's track function setting screen by performing the following menu operations.

[Menu] button → Settings → Target Track

| Setting Item | Description of Setting | Setting Value |
|-----------------------|--|--|
| Target Track Function | Turn On/Off the target track function. | To enable: Select. To disable: Clear. |

Shortcuts

Click on any of the following shortcuts to display the related dialogue box.

| Shortcut | Settings Dialogue Box |
|-----------------------|--|
| View for Target Track | Display the dialogue by selecting [View] – [Target Track]. |
| File Load/Save | Display the dialogue by selecting [Tools] – [File Manager] – [File Load/Save]. |

13.14 Setting NAVTEX

Set the display method of the NAVTEX message that is displayed when the [NAVTEX] button of the information reference window is clicked on.

[Operation procedure]

[Menu] button → Settings → NAVTEX

The following table shows the setting items.

| Setting Item | Description of Setting | Setting Value |
|--|---|--|
| Show NAVTEX | Enable/disable the display of the NAVTEX mark. | To enable: Select. To disable: Clear. |
| Navigation Alarm | Set highlighted display of navigation alarm. When this item is enabled, the alarm message is displayed in black characters on the yellow background. | To enable: Select. To disable: Clear. |
| Weather Alarm | Set highlighted display of weather alarm. When this item is enabled, the alarm message is displayed in black characters on the yellow background. | To enable: Select. To disable: Clear. |
| Ice Warning | Set highlighted display of ice warning. When this item is enabled, the alarm message is displayed in black characters on the yellow background. | To enable: Select. To disable: Clear. |
| Search and Rescue Information | Set highlighted display of search and rescue information. When this item is enabled, the information is displayed in black characters on the yellow background. | To enable: Select. To disable: Clear. |
| Extended Navigational Information | Set highlighted display of supplementary information of navigation warning. When this item is enabled, the information is displayed in black characters on the yellow background. | To enable: Select. To disable: Clear. |
| [Display Filtering for NAVTEX Messages] button | When this button is clicked on, the [Display Filtering for NAVTEX Messages] dialogue is opened. For details, refer to “Displaying only the NAVTEX messages that satisfy a specific condition”. | - |

Displaying only the NAVTEX messages that satisfy the specific conditions

When the [Display Filtering for NAVTEX Message] button is clicked on, the [NAVTEX Message Request] dialogue is opened.

NAVTEX message to be displayed can be filtered on this dialogue.

| Setting Item | Description of Setting | Setting Value |
|---------------------------|--|--|
| Station-Display Filtering | Select a base station from which messages are to be displayed. When the [Display Filtering] check box is selected, selection of the check box of each base station is enabled. Select a required base station by checking the check box. | To enable: Select. To disable: Clear. |
| Month/Year | Only the messages that are received on the selected month/year are displayed. Select a required month/year by checking the check box. | To enable: Select. To disable: Clear. |
| Message-Display Filtering | Select a type of the messages to be displayed. When the [Display Filtering] check box is selected, selection of the message type check box is enabled. Select a required message type by checking the check box. | To enable: Select. To disable: Clear. |

13.15 Setting an Event Mark

Set a shape and a colour of the mark that is set as an event mark.

[Operation procedure]

Open the event mark setting screen by performing the following menu operations.

[Menu] button → Settings → Event Mark

Contact In (RPU) list

Set a shape and a colour of the event mark that is set by contact input.

| Setting Item | Description of Setting | Setting Value |
|--------------|---|---|
| No. | Display the number for setting the event mark. Numbers 1 to 3 correspond to Contact In 1 to 3 of RPU. | - |
| Type | Select a shape of the event mark to be set from the combo box. | 29 mark types For the details, refer to "10.5.3 Selecting an object type". |
| Colour | Select a colour of the event mark to be set for each number from the combo box. If Selected Colour is selected, the colour is selected by the user map colour of the top screen (refer to 2.2.8 Other Common Area). | White / Grey / Amber / Magenta / Blue / Cyan / Green / Yellow / orange / Dark Red / Selected Colour |

Contact In (SLC) list

Set a shape and a colour of the event mark that is set by contact input.

| Setting Item | Description of Setting | Setting Value |
|--------------|---|---|
| No. | Display the number for setting an event mark. No.1 corresponds to Contact In 1 of SLC, No.2 corresponds to Contact In 2 of SLC, No.3 corresponds to Contact In 3 of SLC, and No.4 corresponds to Contact In 4 of SLC. | - |
| Type | Select a shape of the event mark to be set from the combo box. | 29 mark types For the details, refer to "10.5.3 Selecting an object type". |
| Colour | Select a colour of the event mark to be set for each number from the combo box. If Selected Colour is selected, the colour is selected by the user map colour of the top screen (refer to 2.2.8 Other Common Area). | White / Grey / Amber / Magenta / Blue / Cyan / Green / Yellow / orange / Dark Red / Selected Colour |

13.16 Setting Datum Conversion

Set for conversion of datum to the Japanese datum.

[Operation procedure]

Open the datum conversion setting screen by performing the following menu operations.

[Menu] button → Settings → Geodetic

| Setting Item | Description of Setting | Setting Value |
|-------------------------------|--|--|
| Convert WGS-84 to Tokyo Datum | Enable/disable the data conversion function. Disable: Received data is used without performing datum conversion for the own ship's latitude and longitude and received AIS latitude and longitude. Enable: When the datum of the own ship's latitude and longitude is WGS-84 or no DTM sentence has not been received, own ship's latitude and longitude are converted to the Japanese datum. The AIS latitude and longitude are converted to the Japanese datum regardless of own ship's latitude and longitude. | To enable: Select To disable: Clear |
| Except Own Ship's LAT/LON | Set enable/disable to exclude own ship's latitude and longitude from the target of geodetic conversion. Enable: Own ship's latitude and longitude are not converted to geodetic. Disable: Own ship's latitude and longitude are converted to geodetic. When Convert WGS-84 to Tokyo Datum is enabled, this setting is valid. | To enable: Select To disable: Clear |

13.17 Setting Navigation Equipment

Set the navigation equipment.

The bearing that is received when the setting screen is opened is displayed as the default value.

[Operation procedure]

Open the navigation equipment setting screen by performing the following menu operations.

[Menu] button → Settings → General

| Setting Item | Description of Setting | Setting Value |
|--------------|---|---------------|
| Gyro Setting | The initial setting value of the gyro can be input. | 0.0 to 359.9° |

13.18 Setting GPS

Set a GPS receiver.

[Operation procedure]

Open the GPS receiver setting screen by performing the following menu operations.

[Menu] button → Settings → GPS

The items that are displayed vary depending on the version of GPS that is installed.

The following table shows the setting items.

| Setting Item | Description of Setting | Setting Value |
|---------------------|---|--|
| Position | Enter a position of own ship. | 0°00.00' ~ 81°00.00'N/S 0°00.00' ~ 180°00.00'E/W |
| Exclusion Satellite | Enter a satellite number that is to be prohibited from use. This item is displayed only for the GPS of Version R29.xx and earlier versions. | 0 ~ 32 |
| Geodetic Datum | Select a geodetic datum. | 0 ~ 8, 11 ~ 47 (Example) 0: WGS-84 |
| Antenna Height | Enter an antenna height. | Integer within the range from to 8191 |
| Fix Mode | Set a position fixing mode. 2D: Use when obtaining position information from 3 satellites only by assuming the altitude. 3D: Use when obtaining position information from four or more satellites. | 2D / 3D / AUTO |
| DOP Level | Set a HDOP level. The lower the value, the higher the precision becomes and the higher the value, lower the precision becomes. | Up to 4 / Up to 10 / Up to 20 |
| Position Averaging | Set a position averaging level. The display item and input range vary depending on the GPS version. ~R26.00 : Combo box R26.01 ~ 39.99 : Numeric value input box R40.00~ : Numeric value input box (Position/Speed/Course) | <~R26.00> Short / Standard / Long <R26.01 ~ 29.03> 1 ~ 99 sec <R29.04 ~ 39.99> 0 ~ 99 sec <R40.00 ~> 0 ~ 99 seconds |
| Elevation Mask | Limit the satellites to be used according to the elevation angle. | Integer between 5°~ 89° |
| RAIM Level | Set a precision of RAIM that can be used. This item is displayed only for GPS Version R39.00 and later versions. | Off / 10 m / 30 m / 50 m / 100 m |

| Setting Item | Description of Setting | Setting Value |
|--------------|---|--|
| GNSS | Select a system to be used from GLONASS, BDS, and QZSS. However, a combination of GLONASS and BDS is not allowed. This item is displayed only when the GPS Version is R41.00 or a later version and the satellite type is available. | To enable: Select. To disable: Clear. |
| Master Reset | When this item is enabled and the setting value is transmitted, the GPS receiver is initialised. | To enable: Select. To disable: Clear. |
| Send Data | Transmit the setting contents to the GPS receiver. During the transmission, "Sending ..." is displayed as the status. When the transmission is successful, "Completed" is displayed. When the transmission failed, "Not Completed" is displayed. | - |

13.19 Setting DGPS

Set a DGPS receiver.

[Operation procedure]

Open the DGPS receiver setting screen by performing the following menu operations.

[Menu] button → Settings → DGPS

The following table shows the setting items.

| Setting Item | Description of Setting | Setting Value |
|----------------|--|--|
| Select Station | Set a frequency mode that is used by the beacon station. | AUTO / Manual |
| Frequency | Set a frequency that is used by the beacon station. This item can be set only when Manual is selected in station selection. | 275.0 ~ 335.0 kHz |
| Bit Rate | Set a communication baud rate with a beacon station. This item can be set only when Manual is selected in station selection. | 50 / 100 / 200 |
| DGPS Mode | Enable/Disable the DGPS mode. | To enable: Select To disable: Clear |
| DGPS Status | Displays the DGPS status. The status cannot be edited. Frequency: Displays the frequency used. Bit Rate: Displays the modulation speed. RSSI: Displays the received signal intensity. | - |
| Send Data | Send the setting contents to the DGPS receiver. During the transmission, "Sending ..." is displayed as the status. When the transmission is successful, "Completed" is displayed. When the transmission failed, "Not Completed" is displayed. | - |

13.20 Setting SBAS

Set a SBAS receiver.

[Operation procedure]

Open the SBAS receiver setting screen by performing the following menu operations.

[Menu] button → Settings → SBAS

The following table shows the setting items.

| Setting Item | Description of Setting | Setting Value |
|--------------------|---|--|
| Search SBAS | Set whether differential information from the SBAS receiver is received from a beacon or a satellite. | Beacon / SBAS / AUTO |
| Ranging | Set whether the SBAS satellite is used as a positioning satellite. | To enable: Select To disable: Clear |
| Type 0 Information | Set whether the information of prohibited SBAS is used. | To enable: Select To disable: Clear |
| SBAS Select Mode | Set a selection mode of the SBAS satellite number to be used. | AUTO / Manual |
| SBAS No. | Set a SBAS satellite number to be used. This item can be set only when Manual is selected in SBAS selection mode. | 120 to 138 |
| Send Data | Sends the setting contents to the SBAS receiver. During the transmission, "Sending ..." is displayed as the status. When the transmission is successful, "Completed" is displayed. When the transmission failed, "Not Completed" is displayed. | - |

13.21 Setting Cursor, EBL/VRM





Set Cursor, EBL/VRM

[Operation procedure]

Open the Cursor, EBL/VRM setting screen by performing the following menu operations.

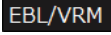
[Menu] button → Settings → Cursor, EBL/VRM

The following table shows the setting items.

| Setting Item | Description of Setting | Setting Value |
|---|--|--|
| Change distance unit to "m" with less than 1 NM | <p>Enable/disable synchronisation of the cursor distance unit and the VRM distance unit.</p> <p>Enable: Based on the range unit setting, when VRM is set to the unit within 1 NM/1 sm/1 km, the VRM distance unit is set to the m unit.</p> <p>Disable: The VRM distance is displayed according to the VRM distance unit setting.</p> | <p>To enable: Select</p> <p>To disable: Clear</p> |
| EBL/VRM Control Cursor | <p>Enable the cursor operation by the EBL/VRM dial when the trackball fails to function.</p> <p>Enable: Enables the EBL/VRM cursor operation. The EBL/VRM badge  is displayed on own ship information while the function is enabled, indicating that the EBL/VRM cursor operation is enabled.</p> <p>Disable: Disables the EBL/VRM cursor operation.</p> | <p>To enable: Select</p> <p>To disable: Clear</p> |
| Cross-hair Cursor Pattern | Set up icon of cross-hair cursor type. |  Large/Small  Large/Small  Large/Small  Large/Small |

13.22 Setting Colours and Brightness

Set the colours and brightness of the display contents.

[Operation procedure]

Open the colour and brightness setting screen by performing the following menu operations.

[Menu] button → Settings → Colour and Brightness

| Setting Item | Description of Setting | Setting Value |
|---------------|--|--------------------------------------|
| Day / Night | Set up the colour of the dialogue box itself. | Day1 / Day2 / Day3 / Dusk / Night |
| [Def.] button | Reset all the setting items of the mode that is selected from the [Day/Night] combo box to the default values. | - |

[Display Colour] tab

Set the colours of the display contents.

| Setting Item | Description of Setting | Setting Value |
|----------------------|---|--|
| Outer PPI | Set up the colour outside the PPI. The label changes depending on the screen to be called. | Dark / Black |
| Inner PPI | Set up the colour inside the PPI. This item can be set in radar mode only. | Blue / Dark Blue / Black |
| Character | Set up the text colour. | White / Green / Gold / Orange / Dark Red |
| RADAR Video | Set up the colour of radar video. | Yellow / Green / Orange / Purple / Dark Red |
| RADAR Trails(Time) | Set up the colour of radar trails. | White / Blue / Cyan / Green |
| Target Symbol | Set up the colour of other ship's symbol. | White / Cyan / Green / Orange |
| Range Rings | Set up the colour of range rings. | White / Cyan / Green / Orange |
| Own Symbol/HL/Vector | Set up the colour of own ship symbol, heading line and vector. | White / Cyan / Green / Orange |
| EBL1/VRM1/PI | Set up the colours of EBL1, VRM1, and parallel index lines (PI). | White / Cyan / Green / Orange |
| EBL2/VRM2 | Set up the colour of EBL2 and VRM2. | White / Cyan / Green / Orange |
| Special Line | Set up the colour of special lines. | White / Grey / Amber / Magenta / Blue / Cyan / Green / Yellow / Orange / Dark Red |

| Setting Item | Description of Setting | Setting Value |
|--------------|--|---|
| Fishing Area | Set up the colour of fishing area. | White / Grey / Amber / Magenta / Blue / Cyan / Green / Yellow / Orange / Dark Red |
| Graticule | Set up the colour of latitude and longitude lines. | White / Grey / Amber / Magenta / Blue / Cyan / Green / Yellow / Orange / Dark Red |

[Brightness] tab

Set up the brightness of the display contents.

| Setting Item | Description of Setting | Setting Value |
|----------------------|--|---|
| Character | Set up the text brilliance. | Level1 (Dark) Level2 Level3 Level4 (Light) |
| RADAR Video | Set up the brilliance of radar video. | Level1 (Dark) Level2 Level3 Level4 (Light) |
| RADAR Trails | Set the brightness of the radar image trail. | Level1 (Dark) Level2 Level3 Level4 (Light) |
| Target Symbol | Set up the brightness of other ship's symbol/vector. | Level1 (Dark) Level2 Level3 Level4 Level5 (Light) |
| Range Rings | Set up the brilliance of range rings. | Level1 (Dark) Level2 Level3 Level4 (Light) |
| EBL/VRM/PI | Set up the brilliance of EBL, VRM and parallel index lines. | Level1 (Dark) Level2 Level3 Level4 (Light) |
| Own Symbol/HL/Vector | Set up the brilliance of own ship symbol, heading line and vector. | Level1 (Dark) Level2 Level3 Level4 (Light) |

| Setting Item | Description of Setting | Setting Value |
|----------------|--|---|
| Chart | Set up the brightness of chart. | [C-MAP selected] Level1 (Dark) Level2 (Light) [newpec selected] Level1 (Dark) Level2 Level3 (Light) |
| User Map/Track | Set up the brightness of User Map, Track. | Level1 (Dark) Level2 Level3 Level4 Level5 (Light) |
| Fishing Area | Set up the brightness of fishing area. | Level1 (Dark) Level2 Level3 Level4 Level5 (Light) |
| Graticule | Set up the brightness of latitude and longitude lines. | Level1 (Dark) Level2 Level3 Level4 Level5 (Light) |
| Panel | Set the brightness of the operation unit. | Off Level1 (Dark) Level2 Level3 Level4 (Light) |
| Display | Set the value that is input in the box for the brightness of the display unit. | 0 to 100 ^{*1} |

^{*1} The brightness default values are as follows.

| 26-inch screen | 19-inch screen |
|---|--|
| Day1 / Day2 / Day3: 67 Dusk: 60 Night: 11 | Day 1 / Day 2 / Day 3: 70 Dusk: 62 Night: 10 |

13.23 Setting Sounds

Set volumes of the operation sound, operation error sound, and alarm melody.

When the volume or melody is changed, the selected volume or melody is played back, enabling the user to set while listening to the sound.

[Operation procedure]

Open the sound setting screen by performing the following menu operations.

[Menu] button → Settings → Sounds

[Volume] tab

| Setting Item | Description of Setting | Setting Value |
|------------------------|---|---|
| Key ACK | Set the volume of the sound emitted when the key is pressed. | Off Level1 (Soft) Level2 Level3 Level4 (Loud) |
| Misoperation | Set the volume of the operation error sound. | Off Level1 (Soft) Level2 Level3 Level4 (Loud) |
| Response/Notification | Set the volume of the control response sound to external equipment and control completion notification sound (including the interswitch control) from external equipment. | Off Level1 (Soft) Level2 Level3 Level4 (Loud) |
| Message Notification | Set the volume of the message notification sound. | Off Level1 (Soft) Level2 Level3 Level4 (Loud) |
| Alert Setting Reminder | Set the volume of the sound notifying that the alarm condition has not been set. | Off Level1 (Soft) Level2 Level3 Level4 (Loud) |
| Alarm | Set the volume of the system alarm sound.*1 | Level1 (Soft) Level2 Level3 Level4 (Loud) |

| Setting Item | Description of Setting | Setting Value |
|--------------|---|---|
| Warning | Set the volume of the system warning sound. | Off Level1 (Soft) Level2 Level3 Level4 (Loud) |

[Melody] tab

| Setting Item | Description of Setting | Setting Value |
|---------------|----------------------------------|--|
| Alarm | Set the melody of system alarm. | Sound1 Sound 2 Sound 3 Sound 4 |
| Warning alarm | Set the melody of warning alarm. | Sound 1 Sound 2 Sound 3 Sound 4 |

*1 These volumes may not be selected except Level 4 (Loud) depending on the setting.

13.24 Setting Key Assignment

Set the keys on the operation unit and the functions that are assigned to the [MULTI] dial.

Only the items whose functions are available on the mode screen are displayed on the screen.

[Operation procedure]

Open the key assignment setting screen by performing the following menu operations.

[Menu] button → Settings → Key Assignment

[User Key] tab

| Setting Item | Description of Setting | Setting Value |
|--------------|--|---|
| User Key1 | Select a function to assign to the [USER1] key on the operation unit. When the [Detail] button is clicked on while the button is enabled, the detail setting screen of the function that was assigned is displayed. | Refer to a separate table, "User key list". |
| User Key 2 | Select a function to assign to the [USER2] key on the operation unit. When the [Detail] button is clicked on while the button is enabled, the detail setting screen of the function that was assigned is displayed. | Same as above |

[Multi Dial] tab







| Setting Item | Description of Setting | Setting Value |
|--------------------|--|--|
| Vector Time | When this is selected, the vector length setup function will be manipulated with the [MULTI] control. | To enable: Select. To disable: Clear. |
| Trails Length | When this is selected, the radar trail length setup function will be manipulated with the [MULTI] control. | To enable: Select. To disable: Clear. |
| C UP Angle | When this is selected, the course adjustment function in the course-up mode will be manipulated with the [MULTI] control. | To enable: Select. To disable: Clear. |
| Own Track Colour | When this is selected, the own ship track colour switch function will be manipulated with the [MULTI] control. | To enable: Select. To disable: Clear. |
| Mark/Line Colour | When this item is enabled, the user map colour switching function is operated by the [MULTI] dial. | To enable: Select. To disable: Clear. |
| Manual Tune | When this is selected, the manual tuning function will be manipulated with the [MULTI] control. In Slave (sub display) mode, the item is not displayed. | To enable: Select. To disable: Clear. |
| Display Brightness | When this is selected, the display brightness adjustment function will be manipulated with the [MULTI] control. It cannot be changed since power is always on. | Always Enabled |
| Panel Brightness | When this is selected, the operation unit brightness adjustment function will be manipulated with the [MULTI] control. This item is always displayed. | To enable: Select. To disable: Clear. |
| Gain | When this item is enabled, the gain adjustment function is operated by the [MULTI] dial. When the RADAR function can be used, the item will be displayed. | To enable: Select. To disable: Clear. |
| Sea | When this item is enabled, the sea adjustment function is operated by the [MULTI] dial. When the RADAR function can be used, the item will be displayed. | To enable: Select. To disable: Clear. |
| Rain | When this item is enabled, the rain and snow adjustment function is operated by the [MULTI] dial. When the RADAR function can be used, the item will be displayed. | To enable: Select. To disable: Clear. |

[AZ Keys] tab

| Setting Item | Description of Setting | Setting Value |
|-----------------|--|--|
| AZ 1 | When this is selected, AZ1 can be turned On/Off by pressing the [AZ] key. All checked items can be turned On/Off at once by pressing the [AZ] key. | To enable: Select. To disable: Clear. |
| AZ 2 | When this is selected, AZ2 can be turned On/Off by pressing the [AZ] key. All checked items can be turned On/Off at once by pressing the [AZ] key. | To enable: Select. To disable: Clear. |
| Sector Alarm1 | When this is selected, Sector Alarm 1 can be turned On/Off by pressing the [AZ] key. All checked items can be turned On/Off at once by pressing the [AZ] key. | To enable: Select. To disable: Clear. |
| Sector Alarm 2 | When this is selected, Sector Alarm 2 can be turned On/Off by pressing the [AZ] key. All checked items can be turned On/Off at once by pressing the [AZ] key. | To enable: Select. To disable: Clear. |
| Polygon Alarm1 | This function cannot be used now. | To enable: Select. To disable: Clear. |
| Polygon Alarm 2 | This function cannot be used now. | To enable: Select. To disable: Clear. |
| Polygon Alarm 3 | This function cannot be used now. | To enable: Select. To disable: Clear. |
| Polygon Alarm 4 | This function cannot be used now. | To enable: Select. To disable: Clear. |
| Polygon Alarm 5 | This function cannot be used now. | To enable: Select. To disable: Clear. |
| Polygon Alarm 6 | This function cannot be used now. | To enable: Select. To disable: Clear. |

User Key list

The following table shows the functions that can be assigned to user keys.

| Function | Description | | | | | | |
|---|--|-----------|--------|---|--|---|--|
| Show Preset Menu | <p>Display the pre-registered screen.</p> <p>By displaying a screen to be registered and holding down the key to which [Show Press Menu] is assigned, the screen can be registered/cancelled. A screen can also be registered from the combo box (User) that is displayed on the title bar on each screen. When “Off” is selected in the item of the combo box, the registration is cancelled.</p> <table border="1"> <thead> <tr> <th>Combo box</th> <th>Status</th> </tr> </thead> <tbody> <tr> <td></td> <td>Indicates that the screen is assigned to the user key (User [number that is assigned])</td> </tr> <tr> <td></td> <td>Indicates that the screen is not assigned to the user key.</td> </tr> </tbody> </table> | Combo box | Status |  | Indicates that the screen is assigned to the user key (User [number that is assigned]) |  | Indicates that the screen is not assigned to the user key. |
| Combo box | Status | | | | | | |
|  | Indicates that the screen is assigned to the user key (User [number that is assigned]) | | | | | | |
|  | Indicates that the screen is not assigned to the user key. | | | | | | |
| Show Favourite | Display the favourite list screen. | | | | | | |
| Zoom | Enable/disable the Zoom function. | | | | | | |
| Capture Screen | Execute screen capture. | | | | | | |
| Show Geodetic | Display the geodetic system display screen by selecting [Settings] – [Geodetic]. | | | | | | |
| Clear Target Track | Clear other ship’s track by selecting it. | | | | | | |
| Clear Mark/Line | Clear a mark/line. Select the mark/line on the setting screen that is displayed by pressing the [Detail] button. | | | | | | |
| Plot Event Mark | Enter an event mark on the own ship’s position. Select the event mark on the setting screen that is displayed by pressing the [Detail] button. | | | | | | |
| Plot Mark | Enter a mark on the cursor position. Select the mark to be entered on the setting screen that is displayed by pressing the [Detail] button. | | | | | | |
| Select Obs. Scene | Select an observation scene that was set. Select the observation scene on the setting screen that is displayed by pressing the [Detail] button. | | | | | | |
| Load User Setting (Obs. Scene) | Execute [Settings] – [Obs. Scene Preset] – [Load User Setting] for the observation scene that is currently selected by the user. | | | | | | |
| Add Reference Mark | Add any reference mark on the cursor position. This item can be used in synthesis mode only. | | | | | | |
| Record Operation (Macro name) | Reproduce the key operation that was registered by [Record Operation]. | | | | | | |
| TM Reset | Execute the TM reset function | | | | | | |
| PRF Fine Tuning | Increment by 1, the setting of [Settings] – [TXRX] – [PRF Fine Tuning]. | | | | | | |
| Acquire | Perform the same operation as the acquisition key of the multi-function operation unit. | | | | | | |
| Readout Information | Perform the same operation as the numeric key of the multi-function operation unit. | | | | | | |
| Clear | Execute the Clear function for the object under the cursor. | | | | | | |
| Close All Dialogue | Close all the dialogues/menus that are displayed on the screen. | | | | | | |

13.25 Setting Preferences Information

The main operation/setting information relating to the RADAR mode can be stored and called collectively.

[Operation procedure]

Open the environment setting screen by performing the following menu operations.

[Menu] button → Settings → Preference

The following table shows the display items.

| Display item | Description |
|--------------------------------|--|
| Name | Up to 10 names that have been set by the individuals are displayed. When the file names overflow the display area, the remaining file names are displayed with an abbreviation symbol (...). |
| Save | Save the current setting. |
| Load | Load the selected setting. |
| Delete | Delete the selected setting. |
| Default display configurations | Set the display setting to the default settings. |

To save a preferences

1 Click on the [Save] button.

The confirmation dialogue box appears.

2 Enter a name in the text box and click on the [OK] button.

The current preferences are saved.

A maximum of 64 characters can be entered for a file name. If all the file name characters do not fit in the display area, the remaining file name characters will be displayed with an abbreviation symbol (...).

To cancel saving, click on the [Cancel] button.

When saving is completed, an item is added to a blank line in the Preferences Name list.

To load preferences

1 Select the name of the preferences you want to load, and then click on the [Load] button.

The confirmation dialogue box appears.

2 Click on the [OK] button.

The selected preferences are loaded.

A maximum of 64 characters can be entered for a file name. If all the file name characters do not fit in the display area, the remaining file name characters will be displayed with an abbreviation symbol (...).

To cancel loading, click on the [Cancel] button.

To delete preferences

- 1 Select the name of the preferences you want to delete, and then click on the [Delete] button.**

The confirmation dialogue box appears. A maximum of 64 characters can be entered for a file name. If all the file name characters do not fit in the display area, the remaining file name characters will be displayed with an abbreviation symbol (...).

- 2 Click on the [OK] button.**

The selected preferences are deleted.

To cancel deleting, click on the [Cancel] button.

To set up default display

- 1 Click on the [Default display configurations] button.**

The confirmation dialogue box appears.

- 2 Click on the [OK] button.**

The display configurations are changed to the default values.

To cancel changing, click on the [Cancel] button.

Items of preferences and default display configurations

The items of preferences and default display configurations are shown in the tables below.

Task "Route monitoring"

| Item saved | Preferences save target | | Value set at shipment from factory, value displayed when the [Default display configurations] is pressed |
|-----------------|---|-----------------|--|
| | Location | Item | |
| position sensor | Common screen - Own Ship Information or Maintenance screen - Sensor Selection | Position source | GPS 1*1 |

*1 GPS when there is only one GPS

Task "Collision avoidance"

| Item saved | Preferences save target | | Value set at shipment from factory, value displayed when the [Default display configurations] is pressed |
|---------------------------------|--|--|--|
| | Location | Item | |
| Gain and anti-clutter functions | RADAR screen - Radar signal information | <ul style="list-style-type: none"> • Reception sensitivity adjustment value (Gain) • Sea clutter adjustment value (Sea) • Sea clutter rejection mode • Rain/snow clutter adjustment (Rain) • Rain/snow clutter rejection mode | - |
| Tuning | RADAR screen - Radar system information | <ul style="list-style-type: none"> • Tuning mode AUTO/MAN • Fine tuning value (under MAN) | <ul style="list-style-type: none"> • Tuning mode AUTO/MAN: AUTO • Fine tuning value (under MAN): 0 |
| Range | RADAR screen - Range and mode information | <ul style="list-style-type: none"> • Range scale | 6NM |
| Fixed rings | RADAR screen - Range and mode information | <ul style="list-style-type: none"> • Range rings display On/Off | Off |
| Operational alarms | [Alert] - [Collision Avoidance] - [AIS Lost Warning] | AIS Lost Warning <ul style="list-style-type: none"> • AIS Lost Warning detection target setting On/Off | TT & Activated AIS |

| Item saved | Preferences save target | | Value set at shipment from factory, value displayed when the [Default display configurations] is pressed |
|------------|--|--|---|
| | Location | Item | |
| VRMs | RADAR screen - EBL/VRM read information area | VRM1 (VRM2) <ul style="list-style-type: none"> • Display On/Off • Control right • Distance value • EBL1/VRM1 measurement reference point (blank space/C/D and floating position. In the case of C, the information is stored in the form of DC coordinate and in the case of D, the information is stored in the form of latitude/longitude.) • Unit of VRM distance (commonly applied to both VRM1 and VRM2) | VRM1: <ul style="list-style-type: none"> • Display On/Off: On • Control right: On • Distance value: 0.25 NM • EBL1/VRM1 measurement reference point: Blank space (CCRP) • EBL2/VRM2 measurement reference point: Blank space (CCRP) VRM2: Display Off <ul style="list-style-type: none"> • Unit of VRM distance: NM |
| EBLs | RADAR screen - EBL/VRM read information area | RADAR screen - EBL/VRM read information area EBL1 (EBL2) <ul style="list-style-type: none"> • Display On/Off • Control right • Bearing value • EBL bearing True/Relative (commonly applied to both EBL1 and EBL2) | EBL1 <ul style="list-style-type: none"> • Display On/Off: On • Control right: On • Bearing value: 000.0 EBL2 : Display Off <ul style="list-style-type: none"> • EBL bearing True/Relative: True |

| Item saved | Preferences save target | | Value set at shipment from factory, value displayed when the [Default display configurations] is pressed |
|-----------------------------------|--|--|--|
| | Location | Item | |
| Parallel index lines | RADAR screen - PI (Parallel Index) | RADAR screen – PI (Parallel Index) <ul style="list-style-type: none"> • Display On/Off • Control right PI measurement reference point (blank space/C/D and floating position. In the case of C, the information is stored in the form of DC coordinate and in the case of D, the information is stored in the form of latitude/longitude.) | <ul style="list-style-type: none"> • Display On/Off: Off • Control right: On • Bearing value: 0° • Interval: +0.00 NM Display for All Lines: Off Mode: All Operation Area: One Side Floating: Off Heading Link: Off Reference Bearing: True |
| Display mode of the radar picture | RADAR screen - Range and mode information | <ul style="list-style-type: none"> • Motion mode • Bearing mode | True motion North-up TM reset position |
| Stabilisation Sea/Ground | RADAR screen - Range and mode information | <ul style="list-style-type: none"> • Stabilisation mode (combo box) | Sea |
| Off-centring | RADAR screen - Range and mode information | <ul style="list-style-type: none"> • Off Centre button → Off Centre On/Off state and Off Centre DC position | Off Centre: Off = On Centre |
| Target trails | RADAR screen - Other ship's information | <ul style="list-style-type: none"> • Trail true/relative • Trail length | <ul style="list-style-type: none"> • Trail true/relative: True • Trail length: 6 min |
| Past positions | RADAR screen - Other ship's information | <ul style="list-style-type: none"> • Past POSN | Off |
| Vector mode | RADAR screen - Other ship's information | <ul style="list-style-type: none"> • Vector/past position true/relative | Relative |
| Vector time | RADAR screen - Other ship's information | Vector Length | 6 min |

| Item saved | Preferences save target | | Value set at shipment from factory, value displayed when the [Default display configurations] is pressed |
|---------------------------------------|---|--|--|
| | Location | Item | |
| Automatic radar target acquisition | [Alert] - [New Target Warning] | AZ1 function On/Off AZ1 Start Angle value AZ1 End Angle value AZ1 Start Distance value AZ1 End Distance value AZ2 function On/Off AZ2 Start Angle value AZ2 End Angle value AZ2 Start Distance value AZ2 End Distance value | AZ1 function On/Off: Off AZ1 Start Angle value: 315.0° AZ1 End Angle value: 045.0° AZ1 Start Distance value: 3.00NM AZ1 End Distance value: 3.50NM AZ2 function On/Off: Off AZ2 Start Angle value: 135.0° AZ2 End Angle value: 225.0° AZ2 Start Distance value: 3.00 NM AZ2 End Distance value: 3.50 NM |
| Graphical AIS reported target display | [View] - [Target] | AIS Symbol display On/Off TT Symbol display On/Off | AIS Symbol display On/Off: On TT Symbol display On/Off: On |
| Radar and AIS Target fusion | [Settings] - [Association] | Association function On/Off | On |
| Collision warning | RADAR screen - Other ship's information (Vector/Past POSN/Limit/Trails) | CPA limit TCPA limit | CPA limit: 2.0 NM TCPA limit: 12 min |

13.26 Setting Screen Capture

Set screen capture.

[Operation procedure]

Open the screen capture setting screen by performing the following menu operations.

[Menu] button → Settings → Screen Capture

The following table shows setting items.

| Setting Item | Description of Setting | Setting Value |
|-----------------------|--|--|
| AUTO Capture Interval | Set up the interval at which the Screen Capture dialogue box is automatically saved. If this is set to 0, the Screen Capture dialogue box will not automatically be saved. | 0 to 999 min |
| AUTO File Erase | Specify whether or not to delete the screen shot file automatically. | To enable: Select. To disable: Clear. |

Shortcut

| Shortcut | Settings Dialogue Box |
|-----------------|---|
| File Management | Display the [Tools] - [File Manager] - [File Management] tab. |

Section 14 Adjusting and Setting up Equipment (for Services)

This section describes the methods for radar adjustment, installation verification, and maintenance that are conducted by the service staff by using the Service menu at installation construction of this equipment.

CAUTION



Never make adjustments while sailing.

Doing so may adversely affect the radar functions, causing accidents and/or malfunctions.

14.1 Service Menu

The Service menu consists of three submenus of Adjustment, Installation and Maintenance. To display the Service menu, a password is required.

[Operation procedure]

Open the Code Input screen by performing the following menu operations.

[Menu] button → Code Input

1 Enter password “0” in the Code Input screen.

When the Code Input screen is closed, open the Service menu by performing the following menu operations.

[Menu] button → Service

2 Select one of the submenus, ([Adjustment], [Installation], [Maintenance]) and display the dialogue.

14.2 Radar Adjustment

Use the [Adjustment] dialogue to adjust the radar of this equipment.

14.2.1 Performing basic adjustments on the radar

Perform basic adjustments on the radar by using the [Basic Adjustment] dialogue.

[Operation procedure]

Open the basic radar adjustment screen by performing the following menu operations.

[Menu] button → Service → Adjustment → Basic Adjustment

14.2.1.1 Tune adjustment

Memo

- After replacement of the magnetron, perform rough tuning while the image is stable after setting the radar to the Standby state for 20 to 30 minutes as the preheating time, operating the radar from the short pulse range, and shifting the operation to the long pulse range sequentially.
- This operation is disabled when the Radar Interswitch is set to the Slave mode.
- Not displayed when the solid-state radar antenna is connected.

1 Click on the [Tune Adjustment] (coarse tuning adjustment) input box.

A numeric value input keyboard is displayed. (0 to 127)

2 Enter an adjustment value (0 to 127) in the input box so that the tuning bar indicates the maximum level (the tuning bar touches the right-most position).

For the method of using the numeric value input keyboard, refer to "3.19.2 Name and function of each section of the keyboard".

14.2.1.2 Automating coarse tuning adjustment

Select MAN (manual)/AUTO (automatic) in the [Tune Adjustment Mode] (tuning mode) combo box. This setting is displayed only when [NKE-2255-7/9/6HS] is connected as the radar antenna. This setting is not displayed when any other radar antenna is connected.

[MAN] (Manual):

Cancels automation of coarse tuning adjustment. Tuning is to be adjusted manually.

[AUTO] (Automatic):

Coarse tuning adjustment is automated.

14.2.1.3 Adjusting the bearing

Adjust the bearing so that the bearing of the target measured by the compass on the ship and the bearing of the image that is displayed on the radar match.

Memo

This function is disabled in rader interswitch mode.

- 1 Set the bearing mode to [H UP] on a top screen and set the image processing mode to [Process Off].**

For the bearing mode setting method, refer to "5.4.5 Setting the azimuth mode" and for the image processing mode setting method, refer to "5.4.4 Using video processing (Echo Process)".

- 2 Measure a bearing in the ship's heading direction of a suitable target (for instance, halted ship, breakwater, and buoy) by using the compass on the ship.**

- 3 Click on the [Bearing Adjustment] input box.**

A numeric value input keyboard is displayed.

- 4 Input an adjustment value in the input box so that the bearing of the target that was measured in Step 2 indicates a correct bearing. (0 to 359.9°)**

For the method of using the numeric value input keyboard, refer to "3.19.2 Name and function of each section of the keyboard".

14.2.1.4 Adjusting a distance

Adjust the distance of the target on the screen so that the correct distance is displayed.

- 1 On the radar screen, specify a target whose distance is available in advance.**

- 2 Click on the [Range Adjustment] input box.**

A numeric value input keyboard is displayed.

- 3 Enter an adjustment value in the input box so that the distance of the target specified in Step 1 indicates the correct distance. (128 to 1024)**

For the method of using the numeric value input keyboard, refer to "3.19.2 Name and function of each section of the keyboard".

14.2.1.5 Radar operation modes

Click on one of the radar operation mode buttons to select either the [Master] mode or the [Slave] mode.

[Master] : Can control the radar antenna.

[Slave] : Cannot control the radar antenna. The display unit uses the radar signals controlled by the master radar antenna.

Memo

While in the Slave mode, the operation to control the radar antenna is disabled.

14.2.2 Adjusting radar antenna

Adjust the radar antenna by using the [TXRX] dialogue.

[Operation procedure]

Open the radar antenna adjustment dialogue by performing the following menu operations.

[Menu] button → Service → Adjustment → TXRX

14.2.2.1 Adjusting an radar antenna height

- 1 Measure the height from the sea surface to the radar antenna.**
- 2 In the [Antenna Height] combo box, select a setting value corresponding to the antenna height that was measured in Step 1.**
 - Under 5 m
 - 5-10 m
 - 10-20 m
 - 20 m Over

14.2.2.2 Setting a tuning bar peak value

Set the scale when the tuning indication bar touches the peak value.

Memo

- This function is disabled under radar slave mode.
- Not displayed when a solid-state radar antenna or a NKE-2255 radar antenna is connected.

- 1 Set the range to 48 NM or more.**
- 2 Click on the [Tune Indicator] (tuning bar adjustment) input box.**

A numeric value input keyboard is displayed.
- 3 Input a setting value in the input box so that the tuning bar oscillates within the range from 80% to 90% of the maximum amplitude position (0 to 127).**

For the method of using the numeric value input keyboard, refer to "3.19.2 Name and function of each section of the keyboard".

14.2.2.3 Adjusting a tuning peak value

Adjust a tuning indication and an echo peak.

Memo

- Disabled in radar slave mode.
- Displayed under 10 kW radar (NKE-2103-4/6/6HS) only.

- 1 Adjust the tuning indication bar as described in “14.2.2.2 Setting a tuning bar peak value”.**
- 2 Set the range to 48 nm or more.**
- 3 Click on the [Tune Peak Adjustment] (adjustment peak value) input box.**
A numerical value input keyboard is displayed.
- 4 Adjust the tuning peak adjustment value so that the radar image becomes strongest when the tuning indication at the top left corner of the screen points to the maximum.**
For the method of using the numerical value input keyboard, refer to “3.19.2 Name and function of each section of the keyboard”.

14.2.2.4 Setting bearing pulse output

- 1 From the [Output BP] combo box, select a bearing pulse count (2048 or 4096) that is output from the radar antenna.**

14.2.3 Adjusting a radar performance monitor

To adjust a radar transmitting/receiving status, use the [Performance Monitor] dialogue or the [Performance Monitor (SSR)] dialogue.

[Operation procedure]

Open the radar transmitting/receiving status adjustment screen by performing the following menu operations.

[Menu] button → Service → Adjustment → MON / MON (SSR)

14.2.3.1 Displaying the [Performance Monitor]/[Performance Monitor (SSR)] dialogue

When [MON] is selected in the classification pane, the [Performance Monitor] dialogue (when a magnetron radar is used) or the [Performance Monitor (SSR)] dialogue (when a solid-state radar is used) is displayed. The items to be displayed change according to the type of the radar antenna.

Memo

- When the radar is in the Slave mode, the [Performance Monitor] dialogue (or [Performance Monitor (SSR)] dialogue) is disabled.
- If a master unit other than straight connection is being set in interswitch setting, the "Performance Monitor" screen (or "Performance Monitor (SSR) " screen) is disabled (may also be enabled depending on the equipment setting.).
- When the [Performance Monitor] dialogue is displayed, the sector blank in the PPI screen is hidden. When the solid state radar antenna is connected, the PM sector is displayed; in the case of the magnetron radar, the sector is not displayed.
- While adjusting the performance monitor, TGT acquisition is not cancelled by the target tracking function.
If a TGT symbol is displayed inside a pattern of the performance monitor and adjusting is difficult, cancel TGT acquisition once.

14.2.3.2 Adjusting a performance monitor of magnetron radars (NKE-2103, NKE-1130/A)

On the [Performance Monitor] dialogue, adjust a magnetron radar transmitting/receiving status while checking the performance monitor level.

Adjusting a monitor reception level

Adjust the circuit for monitoring the radar equipment reception performance.

- 1 Click on the [MON Adjustment] (performance monitor adjustment) input box.

A numeric value input keyboard is displayed.

- 2 Enter a setting value in the input box so that the farthest position of the performance monitor pattern becomes 18.00 NM. (0 to 127)

For the method of using the numeric value input keyboard, refer to "3.19.2 Name and function of each section of the keyboard".

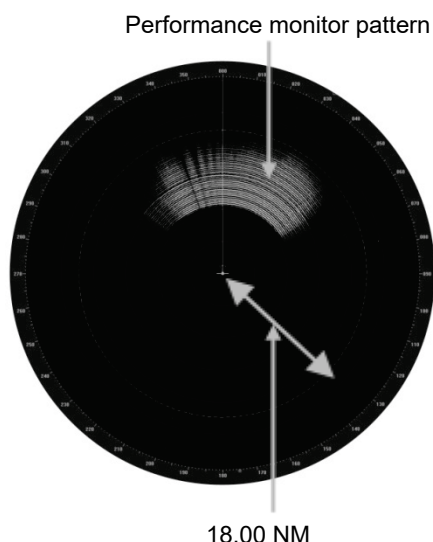

Adjusting a monitor transmission level

Adjust the circuit for monitoring the radar equipment transmission performance.

- 1 Click on the [MON Indicator Adjustment] (performance monitor indicator adjustment) input box.

A numeric value input keyboard is displayed.

- 2 Enter a setting value so that the MON level indicates "8" (0 to 127).

For the method of using the numeric input keyboard, refer to "3.19.2 Name and function of each section of the keyboard".

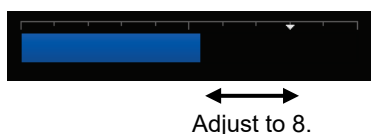

14.2.3.3 Adjusting a performance monitor of a magnetron radar (NKE-2255)

Use the [Performance Monitor] dialogue.

Perform the following adjustments based on the transmitting/receiving attenuator value as the reference.

Memo

- [PM Sector] (monitor sector) influences both the transmission monitor and the reception monitor.
- Do not change the value set in the [PM TI Sector] (transmission sector in monitoring) input box.
- Do not change the values set in the [TX Monitor Timing] (transmission monitor timing adjustment value) input box and the [RX Monitor Timing] (reception monitor timing adjustment value) input box.
- Adjust the direction of orientation before adjusting the monitor level.

Adjusting a monitor reception level

Adjust the circuit for monitoring the radar equipment reception performance.

- 1** Select the [PM Sector] tab, and adjust a value so that the maximum value will be displayed in [RX Level] for the [Start Angle] (starting angle) and [End Angle] (ending angle).



When changing the PM Sector, take care about the following two items.

- Sector width : Maintain Start Angle – End Angle = +10 degrees or -350 degrees.
- Estimated Start Angle : +350 degrees to +20 degrees. (Heading direction)

- 2** Click on the [RX Monitor Adjustment] (reception monitor adjustment) input box.
A numeric value input keyboard is displayed.
- 3** Input a setting value in the input box so that a value of [0.0±1.0 dB] will be displayed in [RX Level] (received signal attenuation value). (0 to 127)

Adjusting a monitor transmission level

Adjust the circuit for monitoring the radar equipment transmission performance.

- 1** Select the [PM Sector] tab. ([Start Angle] and [End Angle] is already adjusted at adjusting a RX Level.)
- 2** Click on the [TX Monitor Adjustment] (transmission monitor adjustment) input box.
A numeric value input keyboard is displayed.
- 3** Input a setting value in the input box so that a value of [0.0±1.0 dB] will be displayed in [TX Level] (transmitted signal attenuation value). (0 to 127)

14.2.3.4 Adjusting a performance monitor of a Solid State Radar (NKE-1632/A, NKE-2632/A, NKE-2632-H)

Use the [Performance Monitor (SSR)] dialogue.

Perform the following adjustments based on the transmitting/receiving attenuator value as the reference.

Memo

Do not change the values that are set in the [Monitor Range] input box and the [RX Monitor Gain] input box.

Adjusting a monitor reception level

Adjust the circuit for monitoring the radar equipment reception performance.

- 1 Click on the [Monitor Sector] (transmission monitor timing adjustment value) input box.**

A numeric value input keyboard is displayed.

- 2 Input a setting value in the input box so that the maximum value is displayed in [RX Level] (received signal attenuation value).**

For the method of using the numeric value input keyboard, refer to "3.19.2 Name and function of each section of the keyboard".

- 3 Click on the [RX Monitor Adjustment] (received signal monitor adjustment value).**

A numeric value input keyboard is displayed.

- 4 Input a setting value (0 to 127) so that [0.0±1.0dB] is displayed in [RX Level] (received signal attenuation value).**

For the method of using the numeric value input keyboard, refer to "3.19.2 Name and function of each section of the keyboard".

Adjusting a monitor transmission level

Adjust the circuit for monitoring the radar equipment transmission performance.

- 1 Click on the [TX Monitor Adjustment] (transmission signal monitor adjustment value) input box.**

A numeric value input keyboard is displayed.

- 2 Input a setting value in the input box so that [0.0±1.0dB] is displayed in [TX Level] (transmission signal attenuation value). (0~127)**

For the method of using the numeric value input keyboard, refer to "3.19.2 Name and function of each section of the keyboard".

14.2.4 Setting sector blank

The sector blank is an area that has been set up by specifying a fan-shaped range (sector), stopping the transmission in that bearing, and hiding radar echoes. The sector blank runs in the relative bearing using the ship's heading as reference.

Three types of sectors can be set up (sector blanks 1/2/3).

Set sector blank by using the [Sector Blank] dialogue.

[Operation procedure]

Open the sector blank setting screen by performing the following menu operations.

[Menu] button → Service → Adjustment → Sector Blank

14.2.4.1 Setting sector blank

Memo

This function is disabled when the interswtich is in slave mode.

- 1** Select the [Use Sector 1/2/3] check box and select a sector blank to be set.
- 2** Click on the [Make Sector 1/2/3] button corresponding to the sector blank number that was selected in Step 1.

- 3** Draw sector blank with the cursor.

The following information items are displayed regarding the sector blank that is being created.

Start Angle: Sector blank starting angle

End Angle: Sector blank ending angle

14.2.5 Adjusting the TT function

Adjust the following TT function parameters by using the [TT] dialogue.

- Vector constant
- Quantization level
- Target symbol display position
- Gate size used for tracking
- TT limit ring

[Operation procedure]

Open the [TT] dialogue by performing the following menu operations.

[Menu] button → Service → Adjustment → TT

What is quantization level?

A quantization level is a signal level that is recognised by the TT function as a target.

By setting a lower value, input of signals of weak targets in the TT target detection circuit is enabled. However, many unnecessary signals are also input, destabilising acquisition and tracking of targets due to unnecessary signals. It is important to set a value greater than the value for detecting unnecessary signals by 4 or 5.

CAUTION



Do not change the quantization level settings indiscreetly.

If inappropriate values are set, the acquisition of the target tracking function and the tracking function will deteriorate, possibly causing accidents.

14.2.5.1 Setting vector constants

Adjust the vector tracking of the target tracking function.

Memo

Do not change this setting unnecessarily. Normally, set 4 for [Vector Constant].

14.2.5.2 Setting a quantization level at manual acquisition

CAUTION



The quantization level and the tracking performance must not be changed unnecessarily since the optimum values are set. Otherwise, the performances of the target tracking function may be affected and an accident may occur.

- 1 Click on the [VD Level (Manual)] (quantization level at manual acquisition) input box.**
A numeric value input keyboard is displayed.
- 2 Enter a setting value in the input box. (0 to 255)**
For the method of using the numeric value input keyboard, refer to “3.19.2 Name and function of each section of the keyboard”.

14.2.5.3 Setting a quantization level at automatic acquisition.

CAUTION



The quantization level and the tracking performance must not be changed unnecessarily since the optimum values are set. Otherwise, the performances of the target tracking function may be affected and an accident may occur.

- 1 Click on the [VD Level (AUTO)] (quantization level at automatic acquisition) input box.**
A numeric value input keyboard is displayed.
- 2 Enter a setting value in the input box. (0 to 255)**
For the method of using the numeric value input keyboard, refer to "3.19.2 Name and function of each section of the keyboard".

14.2.5.4 Setting a gate size used for tracking

- 1 Select a gate size from the [Gate Size] combo box.**
 - Small
 - Medium
 - Large

14.2.5.5 Displaying a TT limit ring

- 1 To display a TT limit ring, select the [Limit Ring] check box.**

14.2.6 Adjusting MBS

MBS (Main Bang Suppression) adjustment is to adjust a display unit processing circuit in order to suppress main bang, which is the reflection signal from a microwave transmission circuit of a waveguide that normally appears as an image of a circle at the centre of the radar screen.

Perform MBS adjustment by using the [MBS] dialogue.

[Operation procedure]

Open the MBS adjustment screen by performing the following menu operations.

[Menu] button → Service → Adjustment → MBS

WARNING



Do not change Initial Level/Area Offset indiscreetly.

If wrong adjustment is performed, the nearest target will be erased, causing collision to lead to death or serious injury.

14.2.6.1 Performing MBS adjustment

- 1 Click on the [Initial Level] (MBS initial level) input box.**
A numeric value input keyboard is displayed.
- 2 Enter an initial level of MBS so that the image of main bang becomes optimum (faint image remains on the screen). (0 to 1023)**
For the method of using the numeric value input keyboard, refer to "3.19.2 Names and functions of the sections of the keyboard".

14.2.6.2 Adjusting an MBS application range

- 1 Expand the display range up to the range where a main bang can be identified.**
- 2 Click on the [Area Offset] input box.**
A numerical value input keyboard is displayed.
- 3 Adjust the application range so that the main bang adjustment range becomes the optimum (distance where only the main bang section becomes the MBS adjustment range) (-0.200 NM ~ 0.200 NM).**
Adjust the range together with the MBS adjustment to the degree where the nearest target will not be lost.
For the method of using the numerical value input keyboard, refer to "3.19.2 Name and function of each section of the keyboard".

14.3 Verifying Installation and Initial Setting

Use the [Installation] dialogue to verify the installation of this equipment and perform initial setting.

14.3.1 Verifying/setting CCRP (Consistent Common Reference Point)

Set a measurement reference position (CCRP) on own ship by using the [CCRP] dialogue.

[Operation procedure]

Open the CCRP dialogue by performing the following menu operations.

[Menu] button → Service → Installation → System Configuration → CCRP

Memo

Set up the GPS radar antenna correctly. The latitude and longitude data received from the GPS is compensated and then displayed as own ship's latitude and longitude. If the GPS radar antenna is not set up correctly, an AIS symbol and a radar echo may deviate when displayed.

14.3.1.1 Setting CCRP

Set the following items in the [CCRP] dialogue.

| Setting Item | Description of Setting | Setting Value |
|--|---|---|
| Length | Enter the ship's length in the box. | 1.0 to 1022.0 m |
| Beam | Enter the ship's width in the box. | 1.0 to 126.0 m |
| GPSx (When two or more GPS units are present, "x" indicates the unit number.) | Enter the equipment positions of GPSx in the boxes. X: Horizontal axis position on the ship of the applicable GPS (Centre: 0) Y: Front-back axis position on the ship of the applicable GPS (Stern: 0) Memo <ul style="list-style-type: none"> This item may not be displayed depending on the equipment setting. When the input range is changed by modifying [Length] and [Beam], if a value exceeding the input range after modifying has already been entered, the value will be corrected to the maximum or minimum value. | Changes depending on the value of [Length] and [Beam]. If Length=a and Beam=b: X $-b/2$ to $b/2$ Y 0.0 to a For example, <ul style="list-style-type: none"> if Length=1.0 and Beam=1.0: X -0.5 to 0.5 Y 0.0 to 1.0 if Length=700.0 and Beam=70.0: X -35.0 to 35.0 Y 0.0 to 700.0 |

| Setting Item | Description of Setting | Setting Value |
|--|---|--|
| Scanner Unit1 to 8 (equipment positions of radar antennas 1 to 8) | <p>Enter the equipment positions of Radar Antennas 1 to 8 in the boxes.</p> <p>X: Horizontal axis position of radar antennas 1 to 8 on the ship (Centre: 0)</p> <p>Y: Front-back axis position of radar antennas 1 to 8 on the ship (Stern: 0)</p> <p>Memo</p> <ul style="list-style-type: none"> • If "No Equipment" is specified in the [DipSW] settings of the interswitch unit, this is not displayed. • When the input range is changed by modifying [Length] and [Beam], if a value exceeding the input range after modifying has already been entered, the value will be corrected to the maximum or minimum value. | <p>Varies depending on the values set in [Length] and [Beam].</p> <p>When Length =a Beam =b:</p> <p>X $-b/2$ to $b/2$</p> <p>Y 0.0 to a</p> <p>For instance,</p> <ul style="list-style-type: none"> • When Length =1.0 Beam =1.0 X -0.5 to 0.5 Y 0.0 to 1.0 • When Length =700.0 Beam =70.0 X -35.0 to 35.0 Y 0.0 to 700.0 |
| CCRP1/2/3/4 | <p>Enter the positions of CCRP1 to CCRP4 of the ship in the boxes.</p> <p>X: Horizontal axis position of CCRP1/2/3/4 on the ship (Centre: 0)</p> <p>Y: Front-back axis position of CCRP1/2/3/4 on the ship (Stern: 0)</p> <p>Memo</p> <p>When the input range is changed by modifying [Length] and [Beam], if a value exceeding the input range after modifying has already been entered, the value will be corrected to the maximum or minimum value.</p> | |
| Radio button on the left side of each CCRP | Select the position to be used as the ship's CCRP by clicking on the applicable button. | CCRP1 CCRP2 CCRP3 CCRP4 |

14.3.2 Setting a serial port

Verify the setting of the serial port of this equipment and perform initial setting by using the [Serial Port] dialogue.

[Operation procedure]

Open the [Serial Port] dialogue by performing the following menu operations.

[Menu] button → Service → Installation → System Configuration → Serial Port

14.3.2.1 [Diagnosis] lamp light colours

The [Diagnosis] lamp displays the diagnosis result as to whether the sentence of a sensor specified for each serial port is received and the status of ISW/MTR/OPU.

Lit in red: Data not received.

Lit in green: Data is receiving.

Lit in orange: In diagnosis (before decision).

No colour: Serial port is disabled.

14.3.2.2 Setting a serial port

In the [Serial Port] dialogue, allocate sensors to be connected to the serial port on RPU (central processing unit) and the serial port on SLC.

[RPU] tab

[Setting a serial port on RPU]

Set each item as follows.

“Table A Sensors that can be selected by serial ports on RPU” shows selectable sensors.

However, the sensors that actually can be selected vary depending on the equipment setting.

For the sensor communication speed, refer to "Selectable baud rates".

| Setting Item | Description of Setting | Setting Value |
|--------------|--|--|
| GPS | <ol style="list-style-type: none">1. Select the [RPU] tab.2. Enable the serial port for GPS by selecting the [GPS] check box.3. Select a sensor to be connected to the serial port for the GPS from the [Sensor] combo box. When not selecting a sensor, set [-]. | To enable: Select. To disable: Clear. Refer to Table A for selectable sensors. |
| Gyro Compass | <ol style="list-style-type: none">1. Select the [RPU] tab.2. Enable the serial port for Gyro Compass by selecting the [Gyro Compass] check box.3. On the [Sensor] combo box, select a sensor to be connected to the gyro compass serial port. When not selecting a sensor, select 0.1.[-]. | To enable: Select. To disable: Clear. Refer to Table A for selectable sensors. |

Table A: Sensors that can be selected by serial ports on RPU

| Serial port | Sensor name | |
|--------------|---|-----------------|
| GPS | GPS 1 | |
| | GPS 2* ¹ | |
| | GPS 3* ¹ | |
| | GPS 4* ¹ | |
| Gyro Compass | Heading Sensor1 | |
| | Heading Sensor2 | |
| | NSK *Since the following combo boxes are enabled when NSK is selected, select a Heading Sensor to be connected to NSK and Log. | |
| | Heading Sensor | Heading Sensor1 |
| | | Heading Sensor2 |
| | Log | Log1 |
| | | Log2 |

*¹ May not be displayed depending on the number of GPS units

[Setting a serial port of built-in SLC]

Set CH1 to CH6 and gyro serial ports that are directly assigned to the display as shown below.

| Setting Item | Description of Setting | Setting Value |
|--------------|--|---|
| CH1 to CH6 | <ol style="list-style-type: none"> 1. Select the [RPU] tab. 2. Enable the serial port of the channel by selecting the check box. 3. Select a sensor*¹ to be connected to the channel on the [Sensor] combo box. When not selecting a sensor, select [-]. | To enable: Select. To disable: Clear. |
| Gyro | <ol style="list-style-type: none"> 1. Select the [RPU] tab. 2. Enable the serial port of the channel by selecting the [Gyro] check box. 3. In the [Sensor] combo box, select the sensor to be connected to the Gyro serial port. When not selecting a sensor, select [-]. | To enable: Select. To disable: Clear. Selectable sensors: Heading Sensor1(NMEA) Heading Sensor2(NMEA) |

*¹ The following sensors can be selected on the built-in SLC (CH1 to CH6).

However, the sensors that can be actually selected vary depending on the equipment setting.

AUTO, Heading Sensor 1, Heading Sensor 2, Log 1, Log 2, GPS 1, GPS 2, GPS 3, GPS 4, Ship's Clock, Echo Sounder 1, Echo Sounder 2, AIS, NAVTEX, NAVTEX(Japanese), Anemometer, Water Temperature Metre, Current Metre, Climate Metre, ROT Indicator, Rudder, RADAR1(TT RX), RADAR2(TT RX), Alert(to BNWAS), GPS/SAT Buoy, WPT(from Plotter)

[SLC1] tab/[SLC2] tab

[Setting a serial port on SLC]

Set a serial port on the SLC that is installed as follows.

| Setting Item | Description of Setting | Setting Value |
|--------------|---|--|
| CH1 to CH8 | <ol style="list-style-type: none">1. Select the [SLC1] tab or the [SLC2] tab.2. Enable the serial port of the channel by selecting the check box.3. Select a sensor^{*1} to be connected to the channel on the [Sensor] combo box. When not selecting a sensor, select [-]. | To enable: Select. To disable: Clear. |
| CH9/CH10 | <ol style="list-style-type: none">1. Click on the [SLC1] tab or the [SLC2] tab.2. Enable the serial port of the channel by selecting the check box.3. Select a sensor^{*1} to be connected to the channel on the [Sensor] combo box. When not selecting a sensor, select [-]. | To enable: Select. To disable: Clear. |

^{*1} The sensors that can be selected on SLC are indicated below.

However, the sensors that can be selected actually vary depending on the installation setting.

AUTO, Heading Sensor 1, Heading Sensor 2, Log 1, Log 2, GPS 1, GPS 2, GPS 3, GPS 4, Ship's Clock, Echo Sounder 1, Echo Sounder 2, AIS, NAVTEX, NAVTEX(Japanese), Anemometer, Water Temperature Metre, Current Metre, Climate Metre, ROT Indicator, Rudder, RADAR1(TT RX), RADAR2(TT RX), Alert(to BNWAS), GPS/SAT Buoy, WPT(from Plotter)

14.3.2.3 To change the communication settings of the serial port

Display the [Detail] dialogue by clicking on the [Detail] button of the serial port that is enabled.

The setting targets can be checked with the [Source Device] display, the [Terminal] display, and the [Sensor] display ([Gyro Sensor] display and the [Log Sensor] display when NSK is selected).

Set the items that are shown in the following table and click on the [Set] button.

| Setting Item | Description of Setting | Setting Value |
|---------------|---|---|
| Baud Rate | Selects the baud rate of the serial port on the combo box. | Selectable baud rates vary depending on the serial port (refer to "Selectable baud rates"). |
| Stop Bits | Selects the stop bit length of the serial port from the combo box. | 1 / 2 |
| Checksum | Selects the check box and enable the checksum of the sentence of the corresponding serial port. | To enable: Select. To disable: Clear. |
| Data Length | Selects the data length of the corresponding serial port from the combo box. | 5 / 6 / 7 / 8 |
| Buffer Size | Enters the buffer size of the corresponding serial port in the box. | 0 to 10240 byte |
| Parity | Selects the parity of the corresponding serial port from the combo box. | None / Odd / Even |
| Time Out | Enters the time-out duration of the corresponding serial port in the box. | 0 to 999 s |
| HBT check box | Displayed in the case other than the case where [Alert (to BNWAS)] is selected as the sensor. Enables/disables the setting of HBT transmission interval. | To enable: Select. To disable: Clear. |

The "Alert (from Sensor)" only supports the reception of HBT sentences.

Selectable baud rates

| Serial port | Baud rate |
|---------------------------------|---------------------------------|
| Serial port on RPU | |
| GPS | Fixed to 4800 |
| Gyro Compass | 1200/2400/4800/9600/19200/38400 |
| Serial port on the built-in SLC | |
| CH1-4 | 2400/4800/9600 |
| CH5/6 | 2400/4800/9600/19200/38400 |
| Gyro | Fixed to 38400 |
| Serial port on SLC1/SLC2 | |
| CH1-8 | 2400/4800/9600 |
| CH9/10 | 2400/4800/9600/19200/38400 |

14.3.3 Setting own ship's parameters

Set parameter values of own ship by using the [Ship's Parameters] dialogue.

[Operation procedure]

Open the own ship's parameters screen by performing the following menu operations.

[Menu] button → Service → Installation → Ship's Parameters

14.3.3.1 Setting own ship's parameters

Set the following items in the [Ship's Parameters] dialogue.

| Setting Item | Description of Setting | Setting Value |
|-----------------|--|--------------------|
| Ship's Name | Enters own ship's name in the box. | MAX. 20 characters |
| Length | Enters own ship's length in the box. | 1.0 to 1022.0 m |
| Beam | Enters own ship's beam in the box. | 1.0 to 126.0 m |
| Keel-Trans | Enters the distance between the transducer of the depth sounder and the keel. (Required when displaying the water depth with the keel fixed) | 0.0 to 20.0 m |
| MAX Speed Limit | Enters the ship's maximum speed in the box. | 10.0 to 99.9 kn |

14.3.4 Setting the AIS password

Set the AIS password by using the [AIS] dialogue.

[Operation procedure]

Open the AIS password setting screen by performing the following menu operations.

[Menu] button → Service → Installation → Settings → AIS

14.3.4.1 Setting the AIS password

Set the following item on the [AIS] dialogue.

| Setting item | Description of setting | Setting value |
|------------------|--|--|
| Setting Password | To change Voyage data from the external device, JHS-183 requires the password. When the AIS password is changed, change this setting value. When the password is not required, this setting value is ignored in (JHS-182). | Up to 32 characters (numeric value only) |

14.4 Maintenance

Use the [Maintenance] dialogue for maintenance operation of this equipment.

14.4.1 Managing storage

[Operation procedure]

Open the information display screen by performing the following menu operations.

[Menu] button → Service → Maintenance → Information

[Storage] tab

The total storage capacity and available capacity of drive (C:) are displayed in the [Drive Information] list.

The [File Information] list shows the size of each file that is stored in the data folder. The information is available for the files that are managed under [File Manager].

[Hardware] tab

The MAC address is displayed.

14.4.2 Maintaining the radar

Use the [RADAR] dialogue to maintain the radar.

[Operation procedure]

Open the [RADAR] dialogue by performing the following menu operations.

[Menu] button → Service → Maintenance → RADAR

14.4.2.1 Changing the operation mode of the safety switch

Open the list of the [Safety Switch] box and select the operation to be performed when the safety switch of the radar antenna is set to OFF.

| Setting | Operation |
|---------|--|
| TX-Off | <ul style="list-style-type: none">• No radiant section's rotation and transmission• PPI screen in the transmitting state• Maintains the transmitting state without generating BP or BZ alarm |
| Standby | <ul style="list-style-type: none">• No radiant section's rotation and transmission• PPI screen standby |
| TX-On | <ul style="list-style-type: none">• No radiant section's rotation, with transmission• PPI screen in the transmitting state• Maintains the transmitting state without generating BP or BZ alarm |

14.4.2.2 Clearing a radar antenna operation time

The total transmission time and the total motor rotation time of a radar antenna can be cleared.

Clearing the total transmission time of a radar antenna

- 1 Click on the [Clear TX Time] button.

Clearing the total motor rotation time of a radar antenna

- 1 Click on the [Clear Motor Time] button.

Clearing the total fan rotation time of the radar antenna

- 1 Click on the [Clear FAN Time] button.

This item is displayed only when a radar antenna (magnetron/small solid state) is connected.

Clearing the total power supply unit fan rotation time of the radar antenna

- 1 Click on the [Clear PS FAN Time] button.

This item is displayed only when a new type of radar antenna (NKE-2255-7/9/6HS) is connected.

Clearing the total transmission unit fan rotation time of the radar antenna

- 1 Click on the [Clear TX FAN Time] button.

This item is displayed only when a new type of radar antenna (NKE-2255-7/9/6HS) is connected.

14.4.2.3 Replacing a TXRX circuit of a radar antenna

Verify the total transmission time and the total motor rotation time of the radar antenna and use the information as the guideline for replacement.

Acquiring the data of the total transmission time and the total motor rotation time from a radar antenna

- 1 Click on the [TXRX To Display Unit] button.

The data of the total transmission time and the total motor rotation time is acquired from radar the antenna and is stored in a display unit. The time that is acquired is displayed on the [Saved Time To Display Unit] display section.

Transmit: Total time acquired from the radar antenna

Motor Rotate: Total motor rotation time acquired from the radar antenna

FAN Rotate: Total fan rotation time that is acquired from the radar antenna

Displayed only when a radar antenna (small solid state) is connected.

PS FAN: Total power supply unit fan rotation time that is acquired from the radar antenna

Displayed only when a new type of radar antenna (NKE-2255-7/9/6HS) is connected.

TX FAN: Total transmission unit fan rotation time that is acquired from the antenna

Displayed only when a new type of radar antenna (NKE-2255-7/9/6HS) is connected.

Storing data of the total transmission time and the total motor rotation time in the radar antenna

1 Click on the [Display Unit To TXRX] button.

The total transmission time and total motor rotation time saved in the display unit are saved to the radar antenna.

If data is saved normally, the data saved in the display unit will be deleted.

When a command is sent from the display unit to the radar antenna, the transmission result is displayed as follows.

Result waiting state: "Sending..." is displayed blinking at intervals of 1 sec.

When the result is success: "Completed" is displayed.

When the result is failure: "Not Completed" is displayed.

Replacing a TXRX circuit

[Notice] displays the operation procedure and precautions.

- 1 By clicking on the [TXRX To Display Unit] button, load the data of the total transmission time and the total motor rotation time from the radar antenna to the display unit.
- 2 Turn off the power of the system and replace the TXRX circuit.
- 3 Turn on the power of the system and write the data of the total transmission time and the total motor rotation time in the transceiver unit of the radar antenna by clicking on the [Display Unit To TXRX].

Memo

Make sure that data is written to the transceiver unit of the same radar antenna when the data is loaded.

14.4.3 Initialising menu setting values

Initialise menu setting values. To reflect the setting, restart the unit.

[Operation procedure]

Open the initialisation execution selection screen by performing the following menu operations.

[Menu] button → Service → Maintenance → Initialisation

14.4.3.1 Initialising the settings other than equipment configuration

- 1 Click on the [Set Default] button of initialisation (all the settings except the equipment configuration).**

An initialisation and restart confirmation popup window is displayed.

- 2 To execute initialisation of the settings other than the equipment configuration, select the [OK] button.**

The application restarts and initialisation is executed.

When [Cancel] is selected, the initialisation execution selection screen is displayed.

14.4.3.2 Initialising equipment configuration

- 1 Click on the [Set Default] button of initialisation (equipment configuration).**

An initialisation and restart confirmation popup window is displayed.

- 2 To execute initialisation of the equipment configuration, select the [OK] button.**

The application restarts and initialisation is executed.

When [Cancel] is selected, the initialisation execution selection screen is displayed.

14.4.4 Backing up the setup file

Output the setup file in this equipment to an external storage device such as USB memory device.

[Operation procedure]

Open the setting file backup execution screen by performing the following menu operations.

[Menu] button → Service → Maintenance → Settings Backup

14.4.4.1 Backing up the setup file

- 1 Select a backup destination folder path in the text box of [Main Drive C: >>].**

Select a backup destination folder from the [Browse] button or select a folder path by directly entering it on the software keyboard.

When the selected folder does not exist, a new folder is created.

- 2 Click on the [Backup] button.**

During backup processing, [Processing] is displayed under the [Backup] button.

When backup failed, an error message is displayed on the popup window.

Section 15 Maintenance & Inspection

15.1 Maintenance Functions Executed from Menu

This section explains maintenance functions that are executed from the menu.

15.1.1 Setting Date/Time/Time zone

[Operation procedure]

Open the date/time/time zone setting screen by performing the following menu operations.

[Menu] button → Maintenance → Date/Time/Time Zone



| Item | Description | Setting value |
|---|--|--|
| Date | Sets the year, month and day on the calendar. For the details of how to use the calendar, refer to "3.20 Setting a Date and a Time (Calendar Operation)". | - |
| Time (LMT) | Enters the time. The time entered will be reflected on the clock. | 00:00 to 23:59 |
| Time Zone (Time difference) | Selects a current time zone. | -13:30 to +13:30 (Every 30 minutes) (UTC standard) |
| Display Style | Selects a display style of year, month, and day. | YYYY-MM-DD MMM DD,YYYY DD MMM,YYYY |
| Synchronise with Time Source(Date/Time) | Sets synchronisation/asynchronisation of the date and time by using the time information (ZDA sentence) from the time information source (GPS, Ship's Clock). | Synchronise: Select Asynchronisation: Clear |
| Synchronise with Time Source(Time Zone) | Sets synchronisation/asynchronisation of the time zone by using the time zone information (ZDA sentence) from the time information source (GPS, Ship's Clock). | Synchronise: Select Asynchronise: Clear |

Memo

When [Synchronise with Time Source (Date/Time)] is not checked, the time is reset to the initial value at the start of power supply. Therefore, set a correct time manually.

15.1.2 Confirming system information

System information can be confirmed.

| | |
|--|---|
|  WARNING | |
|  | When you want to use a USB memory device to read or write a file, make sure in advance that the USB memory device is not affected by a computer virus. If the indicator is infected with a virus, other equipment will also be infected, with the result that a trouble will occur. |
|  | Before removing the USB memory device, check for the access lamp of the USB memory device and make sure that it is not being accessed. If you remove the USB memory device when it is accessed, data may be destroyed and a trouble may occur. |

[Operation procedure]

Open the software information display screen by performing the following menu operations.

[Menu] button → Maintenance → System Information

[Software] tab

Software information is displayed.

| Memo Some items may not be displayed depending on the equipment configuration. | |
|--|--|
| Item | Displayed information |
| Application | Version of the application software |
| Maintenance No. | 7-digit maintenance number |
| TXRX | Version of the software used for the radar transmitter-receiver unit * This information is displayed when the system is equipped with the RADAR function. |
| No.1 GPS | Software version of No.1 GPS. |
| No.2 GPS | Software version of No.2 GPS. |
| No.3 GPS | Software version of No.3 GPS. |
| No.4 GPS | Software version of No.4 GPS. |
| Save to USB Device | When this button is clicked on, the contents displayed are saved in the USB memory device in text format. |

[Functionality] tab

The availability of the functions that are installed are displayed.

| Item | Displayed information |
|--------------------|--|
| Type name | Displays the type and model name of the system. |
| Plotter | Displays the [Plotter] option licence value (Enable/Disable). |
| MAX TT Number | Displays the TT option licence setting value (30/100). |
| MAX AIS Number | Displays the AIS option licence setting value (180/1000). |
| Save to USB Device | When this button is clicked on, the contents that are displayed are saved in the USB memory device in text format. |

[Specification] tab

The [Specification] tab displays the equipment licence information when the equipment licence is available.

| Item | Displayed information |
|-------------------------------|--|
| Equipment licence information | Displays the licence standard of the equipment licence. |
| Save to USB Device | When this button is clicked on, the contents that are displayed are saved in the USB memory device in text format. |

15.1.3 Checking the GPS status

[Operation procedure]

Confirm the GPS Status by performing the following menu operations.

[Menu] button → Maintenance → GPS Status

The following contents are displayed.

| Item | Displayed information |
|-----------------|--|
| Date/Time (UTC) | Displays the date and time when information is received from GPS. |
| LAT / LON | Displays the latitude and longitude. |
| Altitude | Displays the antenna altitude. |
| Fix Mode | Displays the position fixing mode. One of No Fix, 2D, and 3D is displayed. |
| DOP Level | Displays the HDOP level. |
| RAIM Level | Displays the RAIM level. Displays one of 10 m/30 m/50 m/100 m/Off. |
| WER | Displays the beacon signal error rate. |
| RSSI | Displays the signal strength. |
| RAIM Status | Displays the RAIM status. Displays one of Safe/Caution/Unsafe/No Fix. |
| Fix Status | Displays the position fixing status. Displays one of No Fix/GPS/DGPS. |
| Ver. | Displays the ROM version. The content displayed is R26.00 and so on. |

The following table shows the contents displayed in the satellite information list section.

| Item | Displayed information |
|---------------|---|
| System | Displays the satellite positioning system. Displays one of GPS/QZSS/BDS/GLONASS/Galileo. |
| Satellite No. | Displays the visible satellite number. |
| Fix | Displays the satellite positioning status. Displays one of Use/Demodulation/Non-Demodulation/None-use. |
| Azimuth | Displays the azimuth angle. |
| Elevation | Displays the elevation angle. |
| Level | Displays the SNR signal strength. |

15.1.4 Confirming operating time

Confirm the operating time of this system.

[Operation procedure]

Open the equipment operating time confirmation screen by performing the following menu operations.

[Menu] button → Maintenance → Operating Time

The following table show the contents displayed.

| Item | Displayed information |
|--------------------------------|--|
| Operating Time of Display Unit | |
| Total | Total operating time of this equipment |
| LCD FAN | Total LCD fan operating time. The estimated replacement time is indicated in (). |
| RPU FAN | Total RPU fan operating time. The estimated replacement time is indicated in (). |
| Operating Time of Scanner Unit | |
| Total | Total operating time of the radar antenna |
| Transmit | Total operating time of the transmitter. The estimated replacement time is indicated in (). |
| Motor | Total operating time of the motor. The estimated replacement time is indicated in (). |
| FAN | Total operating time of the radar antenna fan. The estimated replacement time is indicated in (). This item is displayed only when the current radar antenna (magnetron/small solid state) is connected. |
| PS FAN | Total operating time of the power supply unit fan. The estimated replacement time is indicated in (). This item is displayed only when a new type of radar antenna (NKE-2255-7/9/6HS) is connected. |
| TX FAN | Total operating time of the fan of the transmission unit. The estimated replacement time is indicated in (). This item is displayed only when a new type of radar antenna (NKE-2255-7/9/6HS) is connected. |

Memo

[Operating Time of Scanner Unit] is displayed only when the radar antenna is connected in RADAR mode.

15.1.5 Displaying/resetting the current voyage distance

This equipment displays the current voyage distance (estimated voyage distance) that is calculated from the speed over the ground and the speed through the water.

The voyage distance can also be reset.

Memo

While the ship is anchored or sailing at low speed, it takes up to around 2 minutes to reset the current voyage distance.

[Operation procedure]

Open the voyage distance display screen by performing the following menu operations.

[Menu] button → Maintenance → Voyage Distance

The following table shows the items that are displayed.

| Item | Displayed information |
|-------------------------|--|
| Current Voyage Distance | Displays the current voyage distance. |
| Ground | Displays the current voyage distance that was calculated from the speed over the ground. |
| Water | Displays the current voyage distance that was calculated from the speed through the water. |
| Clear | Resets the accumulated voyage distance. When this button is clicked on, a confirmation dialogue is displayed. To reset the voyage distance, click on the [Yes] button, to not reset the voyage distance, click on the [No] button. |

15.1.6 Setting and confirming the sensor source

Set and confirm the sensor source.

15.1.6.1 Setting the sensor source

Select a sensor source.

[Operation procedure]

Open the sensor source setting screen by performing the following menu operations.

[Menu] button → Maintenance → Sensor Selection/Status → Sensor Selection

The table below shows the setting items.

Memo

Some sources may not be selected depending on the configuration.

| Setting item | Setting contents | Setting value |
|--------------|---|---|
| Position | Selects a sensor source of the position information from the combo box. | GPS1 / GPS2 / GPS3 / GPS4 |
| Heading | Selects a heading sensor source from the combo box. When [MAN] is set for the sensor source, a ship's heading value can be input in the [Heading] input box. Ship's heading value input range: 0.0-359.9° | MAN / Gyro1 / Gyro2 / G/C 1 / G/C 2 / MAG1 / MAG2 |

| Setting item | Setting contents | Setting value |
|--------------|--|---|
| STW | Selects a Speed Through Water sensor source from the combo box. When the sensor source is set to [MAN], a Speed Through Water can also be input in the [STW] input box. Speed Through Water value input range: -99.9 - 99.9 kn | MAN / Log1 / Log2 |
| COG/SOG | Selects Course Over the Ground/Speed Over the Ground sensor source from the combo box. When GPS is selected for the sensor source of [Position], the same GPS is selected automatically. | Log1 / Log2 / GPS / TGT |
| Time | Selects a sensor source to be used for time correction of this equipment from the combo box. | GPS Ship's Clock |
| Depth | Selects a water depth sensor source from the combo box. | FWD / AFT / MID / AUTO* / E/S1* / E/S2* |

*1 When both Echo Sounder 1 and Echo Sounder 2 are installed as the water depth sensor sources, E/S1 (AUTO) and E/S2 (AUTO) are displayed instead of AUTO.

15.1.6.2 Checking the sensor source status

Check the sensor source.

[Operation procedure]









Open the sensor source setting screen by performing the following menu operations.

[Menu] button → Maintenance → Sensor Selection/Status → Position Status

The following table shows the items that are displayed.

| Display item | Displayed information |
|--------------|--|
| CCRP1/2/3/4 | Displays any of CCRP1 to CCRP4 that is currently selected. Displays the setting of the CCRP that is selected in the system configuration. X: On-board horizontal axis position of CCRP1/2/3/4 Y: On-board vertical axis position of CCRP1/2/3/4 |

15.2 General Maintenance

|  DANGER | |
|---|---|
|  | Never attempt to check or repair the inside of the equipment. Checking or repair by an unqualified person may cause a fire or an electric shock. Contact our branch office, branch shop, sales office, or our distribution in your district. |
|  | Never remove the cover of this equipment. Touching the high-voltage section inside will cause an electric shock. |
|  | Do not attempt to disassemble or tamper with this equipment. Otherwise, a fire, an electric shock, or a malfunction may occur. |
|  | When conducting maintenance, make sure to turn the main power off. Failure may result in electric shock. |
|  | Turn off all the main powers before cleaning the equipment. Make sure to turn it off since voltage is still outputted from the rectifier even after the indicator and the radar are turned off. Failure may result in equipment failure, or death or serious injury due to electric shock. |
|  | When conducting maintenance work on the radar antenna, make sure to turn all the main powers off. Failure may result in electric shock or injuries. |
|  | Make sure to turn off the radar antenna safety switch. Failure may result in injuries caused by physical contact with the rotating radar antenna. |

For operating this equipment in the good conditions, it is necessary to make the maintenance work as described below. If maintenance is made properly, troubles will reduce. It is recommended to make regular maintenance work.







The general maintenance work common among each equipment is as follows.

Clean the equipment.

Remove the dust, dirt, and sea water rest on the equipment cabinet with a piece of dry cloth. Especially, clean the air vents with a brush for good ventilation.

15.3 Maintenance on Each Unit

15.3.1 Radar antenna NKE-1130/A, NKE-1632/A, NKE-2632/A, NKE-2043, NKE-2063A, NKE-2103, NKE-2255

|  WARNING | | | | | | | | | | | | | | | | | | | | | | | | | | | | | | | | | |
|--|--|---------------------|----------------------|---------------------|----------------------|----------|-----|------|-----|-----------|-----|------|-----|----------|-----|------|-------|----------|-----|------|-------|------------|------|------|-------|------------|-------|-------|---------|------------|-------|-------|---------|
|  | <p>When turning off the power supply, do not hold down the power button of the operation unit. Otherwise, a trouble may occur due to termination failure.</p> | | | | | | | | | | | | | | | | | | | | | | | | | | | | | | | | |
|  | <p>Never directly touch the internal components of the radar antenna or indicator. Direct contact with these high-voltage components may cause electric shock. For maintenance, inspection, or adjustment of equipment components, consult with our branch office, branch shop, sales office, or our distributor in your district.</p> | | | | | | | | | | | | | | | | | | | | | | | | | | | | | | | | |
|  | <p>Do not get close to the radiant section of the radar antenna. It is a rotating part, and it may cause injuries if it suddenly starts rotating and consequently hits the body. The radiant section be installed at a high place such as on the roof of the wheelhouse, on the flying bridge, on the trestle, or on the radar mast so that no one can get close to it.</p> | | | | | | | | | | | | | | | | | | | | | | | | | | | | | | | | |
|  | <p><u>Microwave radiation level of the radar antenna</u> Keep away from the radar antenna during transmission. Microwaves are generated from the front centre of the radiant section of the radar antenna at the levels indicated in the table below. Exposure to microwaves at close range can result in injury (especially damage to eyes).</p> <table border="1" style="width: 100%; border-collapse: collapse;"> <thead> <tr> <th style="width: 25%;">System</th> <th style="width: 25%;">50 W/m²</th> <th style="width: 25%;">10 W/m²</th> <th style="width: 25%;">2.5 W/m²</th> </tr> </thead> <tbody> <tr> <td>NKE-2043</td> <td>n/a</td> <td>40cm</td> <td>n/a</td> </tr> <tr> <td>NKE-2063A</td> <td>n/a</td> <td>22cm</td> <td>n/a</td> </tr> <tr> <td>NKE-2103</td> <td>n/a</td> <td>26cm</td> <td>123cm</td> </tr> <tr> <td>NKE-2255</td> <td>5cm</td> <td>81cm</td> <td>162cm</td> </tr> <tr> <td>NKE-1130/A</td> <td>11cm</td> <td>76cm</td> <td>181cm</td> </tr> <tr> <td>NKE-2632/A</td> <td>1.4cm</td> <td>3.1cm</td> <td>209.8cm</td> </tr> <tr> <td>NKE-1632/A</td> <td>1.5cm</td> <td>3.3cm</td> <td>128.4cm</td> </tr> </tbody> </table> | System | 50 W/m ² | 10 W/m ² | 2.5 W/m ² | NKE-2043 | n/a | 40cm | n/a | NKE-2063A | n/a | 22cm | n/a | NKE-2103 | n/a | 26cm | 123cm | NKE-2255 | 5cm | 81cm | 162cm | NKE-1130/A | 11cm | 76cm | 181cm | NKE-2632/A | 1.4cm | 3.1cm | 209.8cm | NKE-1632/A | 1.5cm | 3.3cm | 128.4cm |
| System | 50 W/m ² | 10 W/m ² | 2.5 W/m ² | | | | | | | | | | | | | | | | | | | | | | | | | | | | | | |
| NKE-2043 | n/a | 40cm | n/a | | | | | | | | | | | | | | | | | | | | | | | | | | | | | | |
| NKE-2063A | n/a | 22cm | n/a | | | | | | | | | | | | | | | | | | | | | | | | | | | | | | |
| NKE-2103 | n/a | 26cm | 123cm | | | | | | | | | | | | | | | | | | | | | | | | | | | | | | |
| NKE-2255 | 5cm | 81cm | 162cm | | | | | | | | | | | | | | | | | | | | | | | | | | | | | | |
| NKE-1130/A | 11cm | 76cm | 181cm | | | | | | | | | | | | | | | | | | | | | | | | | | | | | | |
| NKE-2632/A | 1.4cm | 3.1cm | 209.8cm | | | | | | | | | | | | | | | | | | | | | | | | | | | | | | |
| NKE-1632/A | 1.5cm | 3.3cm | 128.4cm | | | | | | | | | | | | | | | | | | | | | | | | | | | | | | |
|  | <p>Make sure to install the radar antenna at a place higher than human height. Direct exposure to electromagnetic wave at close range will have adverse effects on the human body.</p> | | | | | | | | | | | | | | | | | | | | | | | | | | | | | | | | |
|  | <p>When it is necessary to get close to the radar antenna for maintenance or inspection purposes, make sure to turn the power switch of the display unit to "OFF" or "STBY". Direct exposure to electromagnetic waves at close range will have adverse effects on the human body.</p> | | | | | | | | | | | | | | | | | | | | | | | | | | | | | | | | |



When conducting maintenance work, make sure to turn off the power so that the power supply to the equipment is completely cut off.
Some equipment components can carry electrical current even after the power switch is turned off, and conducting maintenance work may result in electric shock, equipment failure, or accidents.

After the maintenance work, turn the safety switch to stop the radar antenna to "ON".

15.3.1.1 Precautions in mounting the cover

When the cover is removed for regular inspection and replacement of parts and refitted after such work, the procedures of fastening bolts shall be taken with the following precautions:

[NKE-2255,NKE-1130/A,NKE-1632/A,NKE-2632A,NKE-2632-H,NKE-2103,NKE-2063A]

- (1) The proper fastening torque of the fitting bolts (M8) is 1176 to 1470 N•cm (120 to 150 kgf•cm) (which makes the inside water-tight and protects the packings against permanent compressive strain). The packings start sticking out from the cover at a torque of approximately 1470 N•cm (150 kgf•cm). Do not fasten the bolts with a torque exceeding the specified value. Otherwise, the screws may be broken.
- (2) Use an offset wrench of 11 mm × 13 mm or a double-ended wrench of 13 mm × 17 mm (not longer than 200 mm).
- (3) Screw all the bolts by hand first to prevent them playing, then fasten them evenly in order not to cause one-sided fastening. (Fasten the bolts with 25% of the required torque at the first step.)

* Fasten the bolts in the diagonal order.

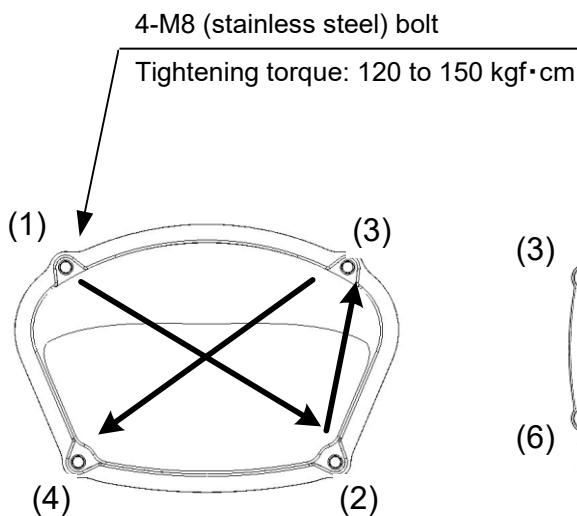

Bolt Tightening Order of
NKE-2255 Cover

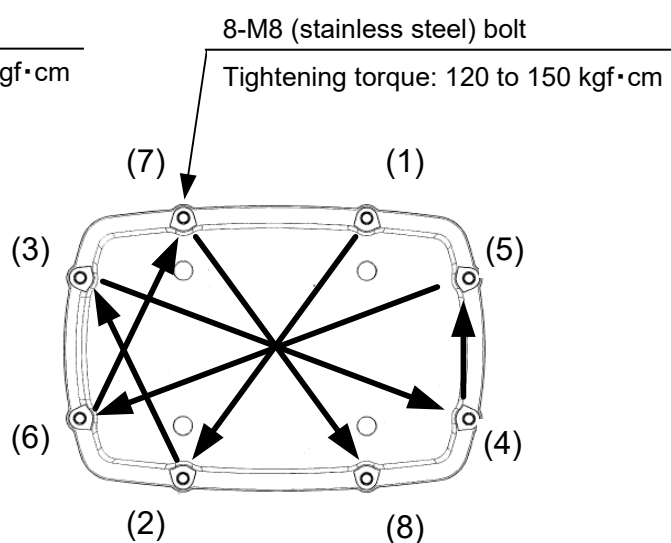

Bolt Tightening Order of
NKE-1130/A、1632/A Cover

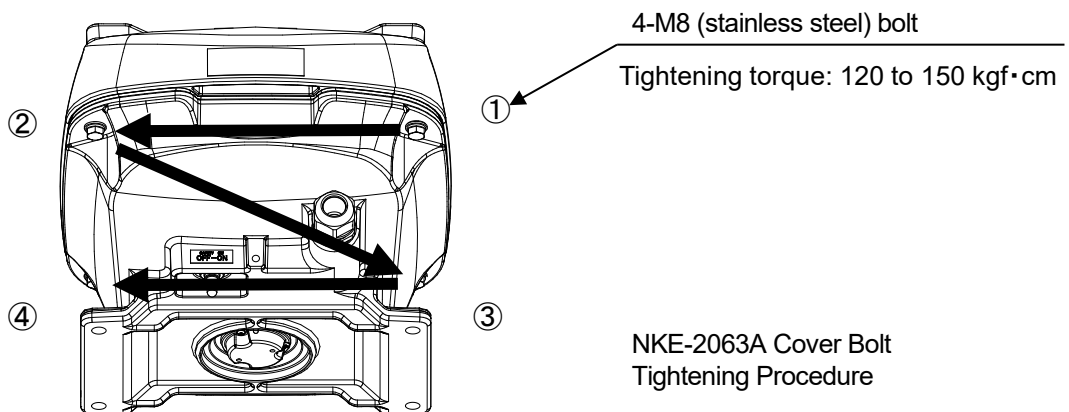
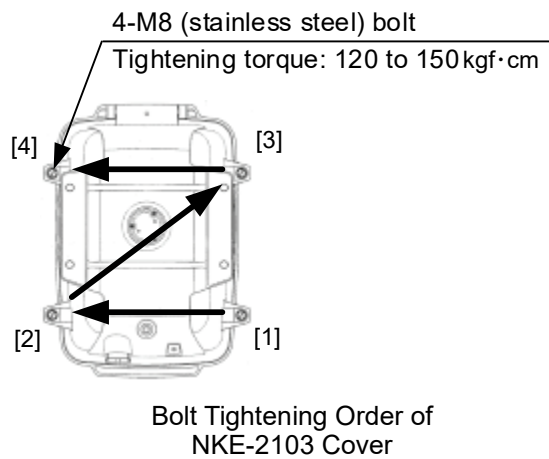
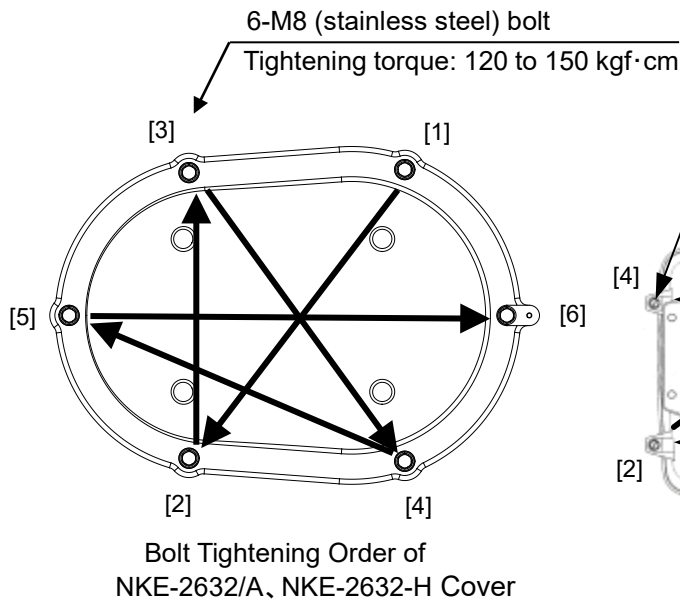

[NKE-2043]

- (1) The proper fastening torque of the fitting bolts (M5) is 102.96 N·cm (10.5kgf·cm) (which makes the inside water-tight and protects the packings against permanent compressive strain). Do not fasten the bolts with a torque exceeding the specified value. Otherwise, the screws may be broken
- (2) Use an 8mm wrench as a tool.
- (3) Screw all the bolts by hand first to prevent them playing, then fasten them evenly in order not to cause one-sided fastening. (Fasten the bolts with 25% of the required torque at the first step.)

*: Fasten the bolts in the diagonal order.

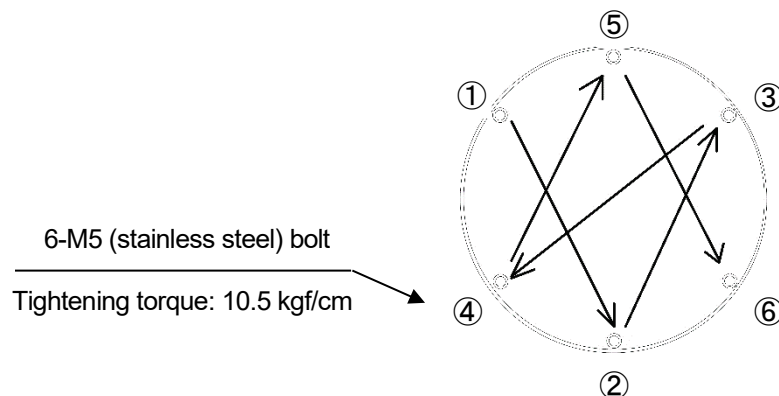

15.3.1.2 Radiator

Perform inspection and cleaning of the radiator.

Memo

- If the radiator front face (radiation plane) is soiled with smoke, salt, dust, paint or birds' droppings, wipe it with a piece of soft cloth wetted with alcohol or water and try to keep it clean at all times. Otherwise, radar beam radiation may attenuate or reflect on it, resulting in deterioration of radar performance.
- Never use solvents of gasoline, benzene, trichloroethylene and ketone for cleaning. Otherwise, the radiation plane may deteriorate.

15.3.1.3 Rotating section

Supply oil seal

When there is not a grease nipple, the replenishment of grease oil is unnecessary.

Remove the cap on the grease nipple located on the front of the part at which the radiator is supported, and grease with a grease gun. Make the oiling every six months. The oil quantity shall be approximate 100 g, which is as much as the grease comes out of the oil seal. Use the grease of Mobilux2 of Mobil Oil.

Oiling gears

Apply grease evenly to the tooth surfaces of the main shaft drive gear and the encoder drive gear with a spreader or brush. Oiling in short intervals is more effective to prevent the gears from wear and tear and extend their service life, but oil at least every six months.

Use the grease of Mobilux2 of Mobil Oil or equivalent.

Mounting legs

Check the mounting legs and mounting bolts of the radar antenna chassis for corrosion at intervals and maintain them to prevent danger. Apply paint to them once a half year because painting is the best measure against corrosion.

15.3.2 Display unit

Dust accumulated on the screen will reduce clarity and darken the video.

For cleaning it, wipe it with a piece of soft cloth (flannel or cotton). Do not wipe it strongly with a piece of dry cloth nor use gasoline or thinner. Otherwise the screen surface may be damaged.

15.4 Performance Check

Make performance check on the radar equipment regularly and if any problem is found, investigate it immediately. Pay special attention to the high voltage sections in inspection and take full care that no trouble is caused by any error or carelessness in measurement. Take note of the results of inspection, which can be used effectively in the next inspection work.

Carry out performance check on the items listed in the check list below.

Check List

| Equipment | Item to be checked | Criteria | Remarks |
|----------------------|---|--|-------------|
| Transmitter-receiver | Synchronisation LED of Receiver | The LED is lit during operation | 48 NM range |
| Display unit | Video and echoes on the screen Sensitivity Brightness Various markers Various numerical indications Lighting | Can be correctly controlled | |
| Radar antenna | Magnetron current | 15.4.5 Checking the magnetron current level of the radar antenna [Magnetron Curr.] | |
| | Performance Monitor | 15.4.7 Checking the performance monitor status | |

15.4.1 Confirming the screen status [Monitor Test]

Confirm the screen status.

[Operation procedure]

Open the Monitor Test screen by performing the following menu operations.

[Menu] button → Maintenance → Diagnosis → Monitor Test

When a colour of the dialogue or pattern button is clicked on in a monitor test, the colour or the pattern is displayed on the screen. Check the status of this screen in the display status. Check the screen status with the display status.

To reset the display, click on the button again.

Pattern list

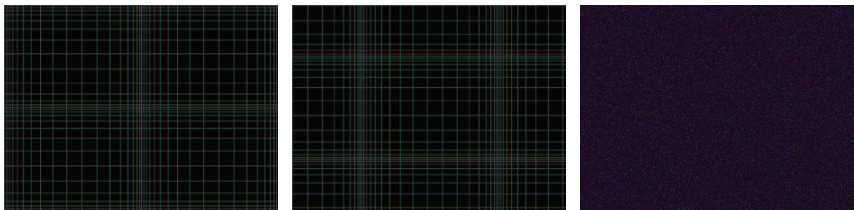
| Pattern button name | Display |
|---------------------|--|
| All Red | The entire screen is displayed in red. |
| All Green | The entire screen is displayed in green. |
| All Blue | The entire screen is displayed in blue. |
| All White | The entire screen is displayed in white. |
| Pattern1 | Displays the pattern for checking the communication quality for VDR.  |
| Pattern2 | |
| Pattern3 | |
| | Patter1 Pattern2 Pattern3 |
| Grey Scale | Displays the grey scale pattern for checking the monitor brightness adjustment. Grey scale patterns can be identified with brightness in day/night mode. By adjusting the monitor brightness to facilitate identification of grey scale patterns, the optimum brightness can be set. The brightness in night mode can also be adjusted in the same way. Use the [Day/Night] button on the right Toolbar to switch between the day mode and the night mode. For the details of the [Day/Night] button, refer to “2.2.5 Right toolbar”. |

15.4.2 Confirming the operation of the operation unit [Key Test]

Confirm the operation of the keys of the operation unit.

[Operation procedure]

Open the Key Test screen by performing the following menu operations.

[Menu] button → Maintenance → Diagnosis → Key Test

Click on the [Key Test Start] button.

The image of the operation unit is displayed.

Operate the keys, buttons and dials in the operation unit.

If the performance of the operation unit is normal, the colours of the keys, buttons and dials are changed.

When multiple operation units are connected, the operation unit can be switched to the one to be tested by using the toggle button provided at the top left corner.

The following table shows the types of operation units.

| Operation unit | | Type |
|-------------------------------|--------------------------------|---------------------|
| Standard operation unit | | NCE-5794 |
| Multi-function operation unit | | NCE-5795 |
| MFD operation unit | Trackball unit | NCE-5605 + NCE-5625 |
| | Trackball unit + keyboard unit | |

Click on the [Key Test Stop] button after the operation check.

Returns to the [Diagnosis] dialogue.

15.4.3 Confirming the alert sound [Sound Test]

Confirm the alert sound.

[Operation procedure]

Open the sound volume test screen by performing the following menu operations.

[Menu] button → Maintenance → Diagnosis → Sound Test

1 **Click on the [Sound Test Start] button.**

A sound volume test starts. All the available beep sound volumes can be tested by increasing the level from 0.

15.4.4 Testing the brightness of LED [Light Test]

Test the brightness of the LED of the operation unit.

[Operation procedure]

Open the Light Test screen by performing the following menu operations.

[Menu] button → Maintenance → Diagnosis → Light Test

1 **Click on the [Light Test Start] button.**

A LED brightness test starts. All the available brightness level can be tested by increasing the level from 0.

15.4.5 Checking the magnetron current level of the radar antenna [Magnetron Curr.]

This function is used to check the magnetron current level of the radar.

This function is displayed only when the magnetron radar antenna is connected.

[Operation procedure]

Open the magnetron current test screen by performing the following menu operations.

[Menu] button → Maintenance → Diagnosis → Magnetron Curr.

The magnetron current level of the radar antenna is displayed.

The current level is normal if it is within the following scope under the 48 NM range.

10 kW transmitter: Scale 4 to 7

25/30 kW transmitter: Scale 6 to 9

Memo

In the sector blank area, the display of the magnetron current becomes unstable.

Check that there are no fluctuations (drift) of 2 scales or more while sector blank is not set. For the details of sector blank setting, refer to "14.2.4 Setting Sector Blank".

15.4.6 Checking the memory [Memory Check]

Check the memory.

[Operation procedure]

Open the Memory Check screen by performing the following menu operations.

[Menu] button → Maintenance → Diagnosis → Memory Check

1 **Click on the [Memory Check Start] button.**

Memory checking starts and the checking result is displayed on the [Result] list.

15.4.7 Checking the performance monitor status

This function is used to check the status of the radar performance monitor.

Items displayed under this function vary depending on the type of the radar antenna.

When a magnetron radar (NKE-2103, 1130/A) is used, refer to “15.4.7.1 MON Check (NKE-2103, NKE-1130/A)”.

When a magnetron radar (NKE-2255) is used, refer to “15.4.7.2 MON Check (NKE-2255)”.

When a solid-state radar (NKE-1632/A, NKE-2632/A, NKE-2632-H) is used, refer to “15.4.7.3 MON Check (NKE-1632/A, NKE-2632/A, NKE-2632-H)”.

15.4.7.1 MON Check (NKE-2103, NKE-1130/A)

[Operation procedure]

Open the performance monitor status checking screen by performing the following menu operations.

[Menu] button → Maintenance → Diagnosis → MON Check

The following table shows the items that are displayed.

| Item | Displayed information |
|--------------------|---|
| Transmitter System | |
| Attenuation Value | Displays the attenuation level of the radar transmitter at the top bar and as the number value [dB]. |
| Receiver System | |
| MON Pattern Range | The distance [NM] is displayed when the user adjusts VRM to the farthest edge of the performance monitor pattern. |
| Attenuation Value | Displays the attenuation level of the radar receiver in [dB]. |

Checking a performance monitor status

Memo

In case of equipped with Interswitch function (Option):

To check the performance with the performance monitor, set the interswitch connection to straight (i.e. No. 1 radar antenna is connected to No. 1 display unit).

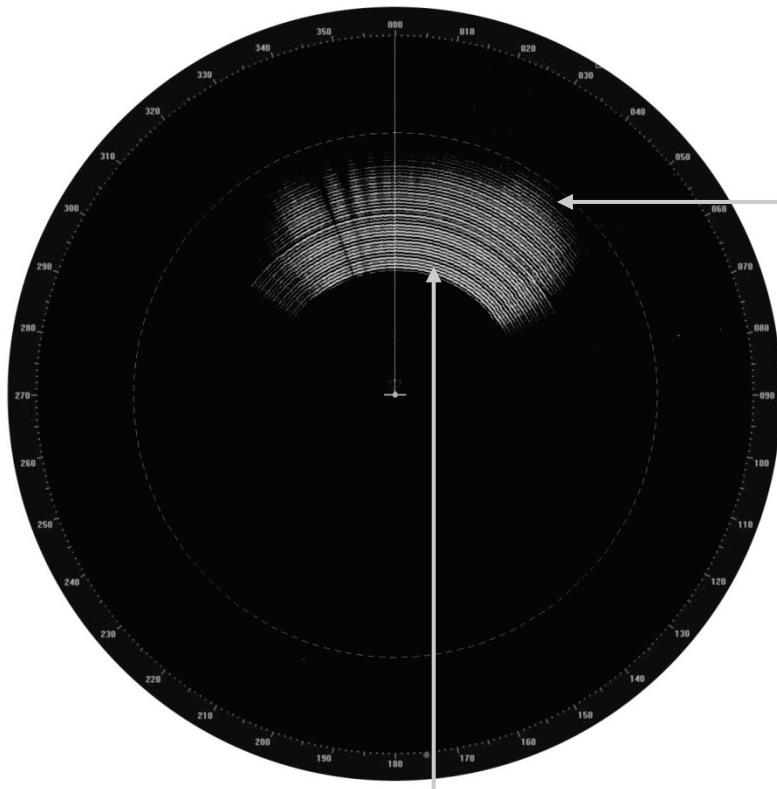

Adjust VRM to the farthest edge of the performance monitor pattern.

Performance monitor pattern
(If the performance of the receiver degrades, the pattern range becomes short.)

- 1 Turn the [VRM] dial of the operation unit to the farthest edge of the performance monitor pattern.

Check the amount of attenuation in the dialogue.

Benchmarks for the amount of attenuation are as follows:

Attenuation Value of Transmitter:

At normal: -6.9 dB to +2.0 dB

At degrading performances: -15.0 dB to -7.0 dB

Attenuation Value of Receiver:

At normal: -2.9 dB to +3.5 dB

At degrading performances: -15.0 dB to -3.0 dB

Memo

- When confirming the attenuation value of the transmitter, after opening the dialogue, wait for one minute, and then read its value.
- If the attenuation value of the transmitter is -7 dB or lesser, or the receiver's attenuation indicator is -3 dB or lesser, it indicates that performances of the transmitter/receiver unit are degrading.

In this case, inspection by the specialized service personnel is required. Contact our dealer, the nearest service representative or JRC sales.

15.4.7.2 MON Check (NKE-2255)

[Operation procedure]

Open the performance monitor status checking screen by performing the following menu operations.

[Menu] button → Maintenance → Diagnosis → MON Check

The following table shows the items that are displayed.

| Item | Displayed information |
|----------|--|
| TX Level | Displays the attenuation level of the radar transmitter in a numeric value [dB]. The guidelines of attenuation values are as follows. Normal: -6.9 dB to +7.0 dB Performance deterioration: -20.0 dB to -7.0 dB |
| RX Level | Displays the attenuation level of the radar receiver in a numeric value [dB]. The guidelines of attenuation values are as follows. Normal: -6.9 dB to +7.0dB Performance deterioration: -20.0 dB to -7.0 dB |

Memo

- When confirming the attenuation value of the transmitter, after opening the dialogue, wait for one minute, and then read its value.
- If the attenuation value of the transmitter is -7 dB or lesser, or the receiver's attenuation indicator is -7 dB or lesser, it indicates that performances of the transmitter/receiver unit are degrading.

In this case, inspection by the specialized service personnel is required. Contact our dealer, the nearest service representative or JRC sales.

15.4.7.3 MON Check (NKE-1632/A, NKE-2632/A, NKE-2632-H)

[Operation procedure]

Open the performance monitor status checking screen by performing the following menu operations.

[Menu] button → Maintenance → Diagnosis → MON Check (SSR)

The following table shows the items that are displayed.

| Item | Displayed information |
|----------|--|
| TX Level | Displays the attenuation level of the radar transmitter in a numeric value [dB]. The guidelines of attenuation values are as follows. Normal: -6.9 dB to +7.0 dB Performance deterioration: -20.0 dB to -7.0 dB |
| RX Level | Displays the attenuation level of the radar receiver in a numeric value [dB]. The guidelines of attenuation values are as follows. Normal: -6.9 dB to +7.0 dB Performance deterioration: -20.0 dB to -7.0 dB |

Memo

- When confirming the attenuation value of the transmitter, after opening the dialogue, wait for one minute, and then read its value.
- If the attenuation value of the transmitter is -7 dB or lesser, or the receiver's attenuation indicator is -7 dB or lesser, it indicates that performances of the transmitter/receiver unit are degrading.

In this case, inspection by the specialized service personnel is required. Contact our dealer, the nearest service representative or JRC sales.

15.4.8 Checking radar information

Check radar information.

[Operation procedure]

Open the radar information screen by performing the following menu operations.



[Menu] button → Maintenance → Diagnosis → RADAR INFO

Check the following values.

| Item | Displayed information |
|------|---|
| TIY | The TIY value is displayed. Range : 400.00 ~ 5400.00[Hz] If the value is outside of the range, Missing is displayed. |
| BZ | The BZ value is displayed. Range : 12.00 ~ 60.00[rpm] If the value is outside of the range, Missing is displayed. |
| BP | The BP value is displayed. Range : 819.20 ~ 4096.00[Hz] If the value is outside of the range, Missing is displayed. |

15.5 Replacement of Major Parts

The system includes parts that need periodic replacement. The parts should be replaced as scheduled. Use of parts over their service life can cause a system failure.

| | |
|--|---|
|  CAUTION | |
|  | <p>Turn off the main power source before inspecting and replacing parts. Otherwise, an electric shock or trouble may be caused.</p> |

15.5.1 Parts expected for periodic replacement



Here are parts expected for periodic replacement.

| Part type | Name | Part name | Life expectancy | Replacement kit type |
|-------------|---------------------------|------------------------------|-----------------|----------------------|
| NWZ-214 | 19inch monitor | FAN | 60,000 hours | 7BFRD0008 |
| NWZ-208 | 26inch monitor | FAN | 40,000 hours | 7ZYNA4005 |
| NDC-1678/A | Processing Unit | FAN | 40,000 hours | 7BFRD0012 |
| NKE-1130/A | S band radar | Magnetron | 4,000 hours | CMG348 |
| | | Motor | 10,000 hours | MDBW10823 |
| | | FAN for motor driver circuit | 20,000 hours | 7BFRD0002 |
| | | FAN for modulation | 20,000 hours | 5BFAB00674 |
| NKE-1632/A | Solid state radar antenna | Motor | 10,000 hours | MDBW10823 |
| | | FAN | 100,000 hours | 109L0912S410 |
| NKE-2632/A | Solid state radar antenna | Motor | 10,000 hours | MDBW10823 |
| | | FAN | 100,000 hours | 109L0912S410 |
| NKE-2632-H | Solid state radar antenna | Motor | 10,000 hours | MDBW10967 |
| | | FAN | 100,000 hours | 109L0912S410 |
| NKE-2043 | X band radar | Magnetron | 4,000 hours | 5VMAA00092 |
| | | Motor | 10,000 hours | 7BDRD0052A |
| NKE-2063A | X band radar | Magnetron | 4,000 hours | 5VMAA00090 |
| | | Motor | 10,000 hours | CBP218 |
| | | Carbon brush | 2,000 hours | BRXP05247 |
| NKE-2103 | X band radar | Magnetron | 4,000 hours | 5VMAA00102 |
| | | Motor | 10,000 hours | 7BDRD0048 |
| NKE-2103-HS | X band radar | Magnetron | 4,000 hours | 5VMAA00102 |
| | | Motor | 10,000 hours | 7BDRD0048 |
| NKE-2255 | X band radar | Magnetron | 4,000 hours | CMG347 |
| | | Motor | 10,000 hours | 7BDRD0044A |
| | | FAN for power unit | 20,000 hours | 7BFRD0010 |
| | | FAN for transmission unit | 20,000 hours | 7BFRD0011 |

| | | | | |
|-------------|--------------|---------------------------|--------------|------------|
| NKE-2255-HS | X band radar | Magnetron | 4,000 hours | CMG347 |
| | | Motor | 10,000 hours | 7BDRD0045A |
| | | FAN for power unit | 20,000 hours | 7BFRD0010 |
| | | FAN for transmission unit | 20,000 hours | 7BFRD0011 |

*When the estimated replacement time arrives, a message urging the replacement will be displayed.

15.5.2 Replacement of magnetron

| | |
|--|--|
|  CAUTION | |
|  | When replacing magnetrons, make sure to shut off the main power and let the equipment stand for more than 5 minutes to discharge the high-voltage circuit. Failure may result in electric shock. |
|  | Make sure to take off your watch when your hand must get close to the magnetron. Failure may result in damage to the watch since the magnetron is a strong magnet. |

Memo

Replacement of magnetron must be made by a specialized service personnel.
For details, refer to Service Manual.
Use necessarily the parts to meet the part types in the above shown in the table.

Do not touch the magnet of the magnetron with a screwdriver or put the magnetron on an iron plate.
When replacing the magnetron, connect the lead wire correctly.

15.5.2.1 Handling of magnetron under long-time storage

The magnetron that has been kept in storage for a long time may cause sparks and operate unstably when its operation is started. Perform the aging in the following procedures:

- 1 **Warm up the cathode for a longer time than usually. (20 to 30 minutes in the standby state.)**

Start the operation from the short pulse range and shift it gradually to the longer pulse ranges.

If the operation becomes unstable during this process, return it to the "Standby" state immediately.
Keep the state for 5 to 10 minutes and then repeat this procedure.

15.5.2.2 Magnetron replacement procedure for radar antenna NKE-1130/A

- 1 Turn Off the safety switch of the radar antenna.

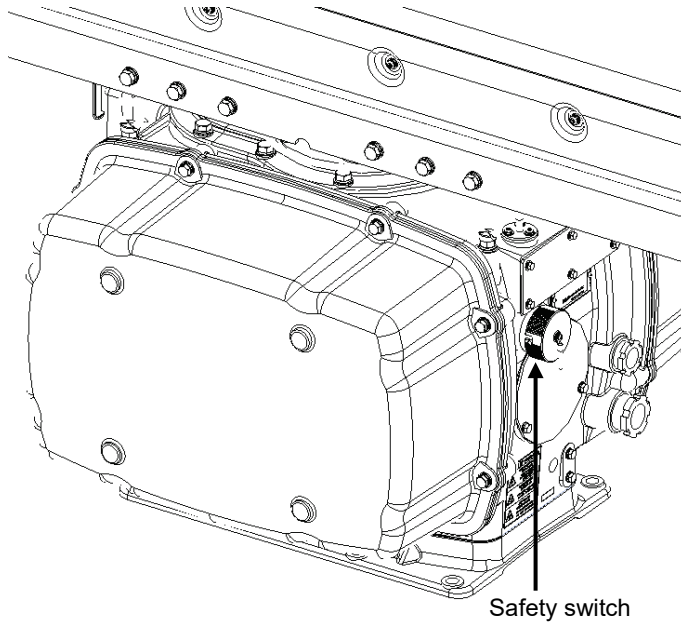

 When replacing a magnetron, ensure that the safety switch of the radar antenna is turned Off prior to commencing the replacement work.

The safety switch is located on the rear (stern) side of the radar antenna.

Remove the cover and turn Off (to the lower side) the safety switch.

Remove the cover.

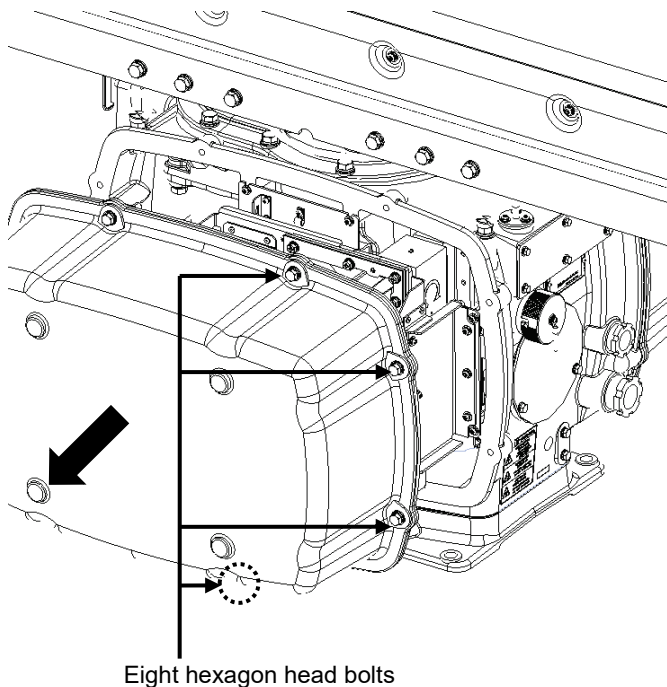

The magnetron is mounted on the left side (port side) of the radar antenna. Remove the left side cover.

The cover is secured in place with hexagon head bolts (M8, designed to be protected from falling out) at eight positions.

After removing the cover, place it in a safe area.

Exercise care to avoid dust or other foreign matters adhering to the packing.

Replace the magnetron.

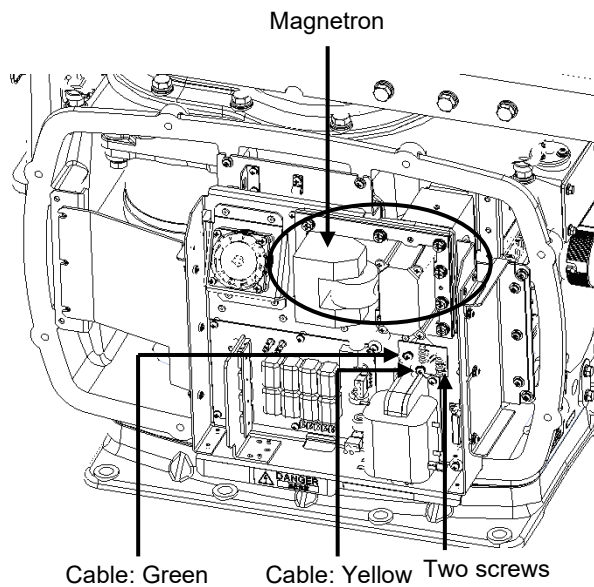

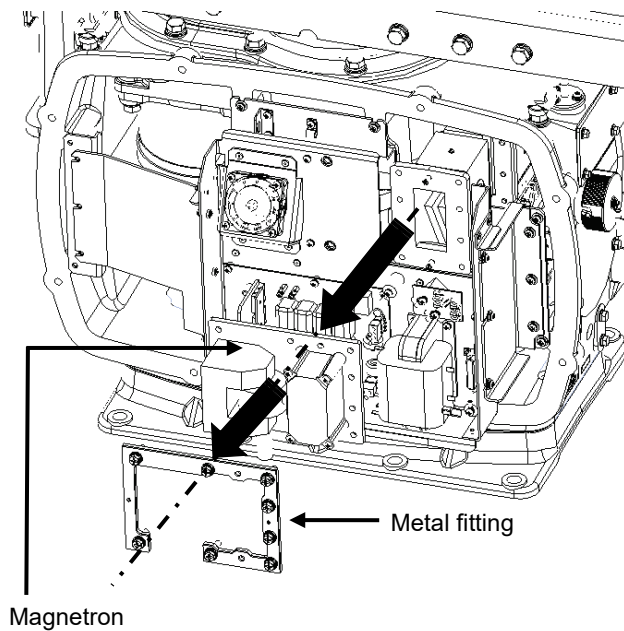

To detach the cables to which the magnetron is connected, remove the two screws (M4×12) holding the cables.

Use caution not to lose the screws after removing them.



The magnetron is secured in place with a special metal fitting. The fitting uses bolts protected from falling out. Loosen all bolts and demount the fitting and bolts together.

 The magnetron is attached to the radar antenna with pins. Use caution not to drop the magnetron.

 Use a shielded screwdriver for this work.

 Contact with metal (tools) can cause performance degradation in the magnetron.

Install a replacement magnetron and cables.

After replacing the magnetron, reassemble the unit by following the same steps in reverse order. Do not forget to tighten the bolts and screws, and do not forget to reconnect the cables.

The above steps complete the magnetron replacement procedure.

15.5.2.3 Magnetron replacement procedure for radar antenna NKE-2043

1 **Remove the radome.**

The radome is fixed with 6 hexagonal bolts.

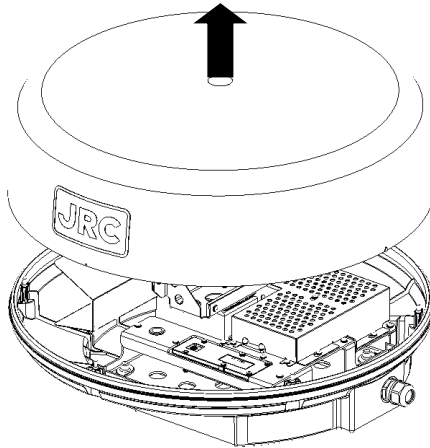

The figure below shows the positions for 6 bolts.

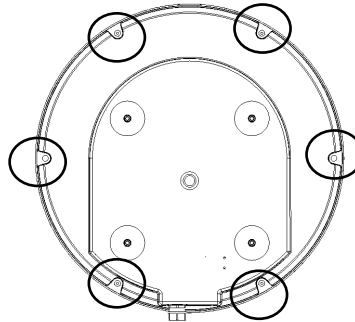

Bottom view

Note:

Place the removed radome in a safe place.

Be sure not to be blown off by the wind.

2 Remove the equipment cable.

Remove the connectors of the equipment cable connected to the transceiver unit.

Remove the cable clamp fixing the equipment cable.

(You do not need to remove the equipment cable from the scanner unit.)

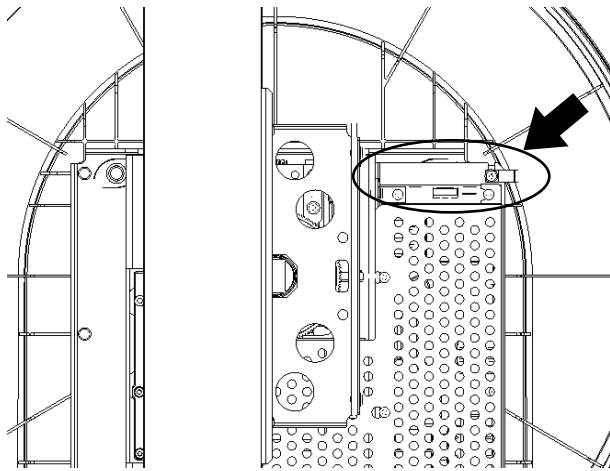

3 Remove the motor cable, the receiver cable and the sensor cable.

Remove the connection cable of the motor unit.

Remove the connection cable of the receiver unit.

Remove the connection cable of the sensor.

When removing the transceiver unit, be sure not to be stuck in parts and be careful not to interfere with the work.

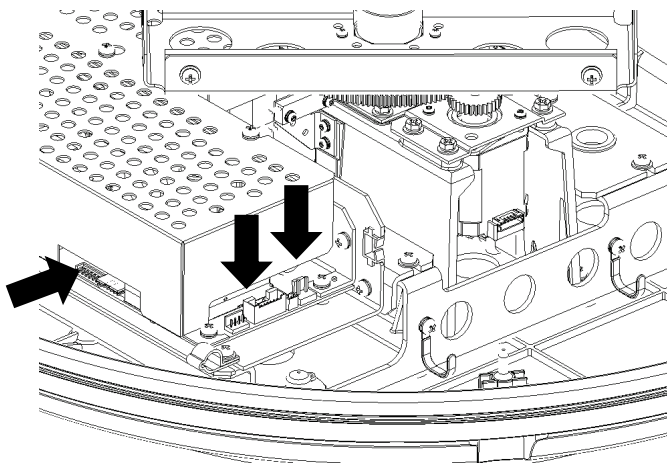

4 **Remove the transceiver unit.**

The transceiver unit is fixed with 5 screws with washer (M4X10Bs_SW_W) and a screw (M4X12_SW_W, fixed with clamp).

- a) Loosen the 3 screw fixing the unit on the bow side.

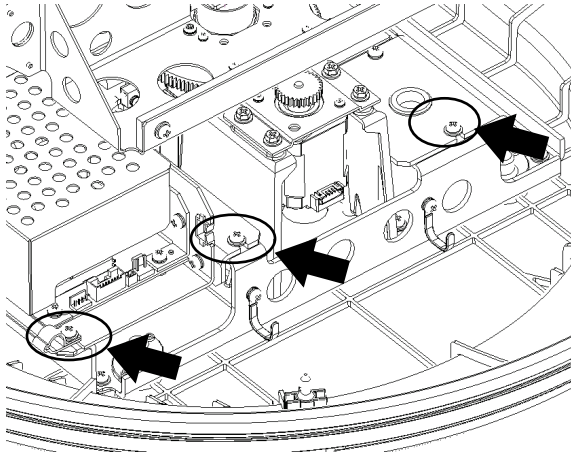

- b) Remove the remaining 3 screws on the stern side.

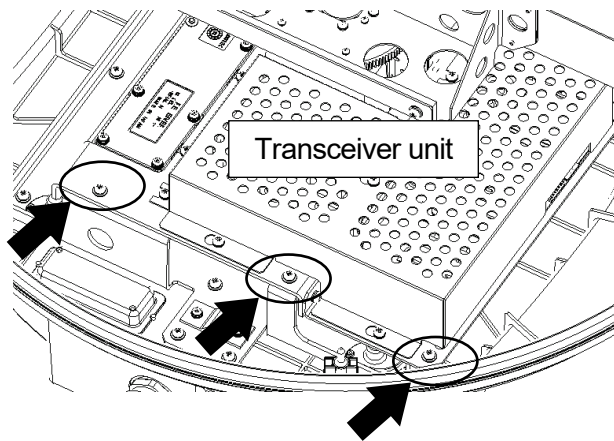

- c) Remove the transceiver unit.

When removing the transceiver unit, once slide it to stern direction and pull it off obliquely backward.

Perform the replacement of circuits within the transceiver unit in a safe place

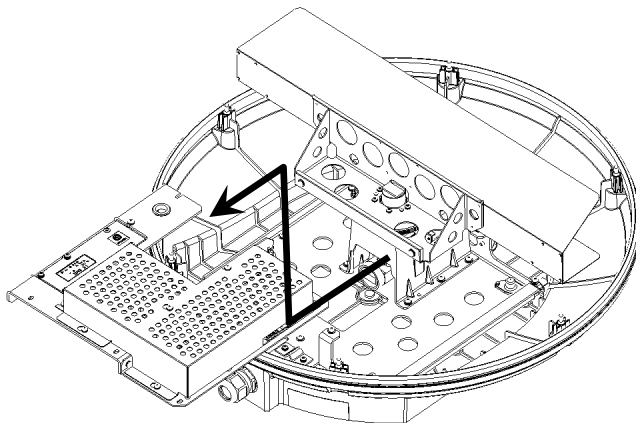

5 **Remove the cover of the transceiver unit.**

Perform the replacement of circuits and parts within the transceiver unit.

Remove the cover of the transceiver unit.

The cover is fixed with 7 screws with washer (M4X10Bs_SW_LW).

Loosen all screws and slide the cover to remove it.

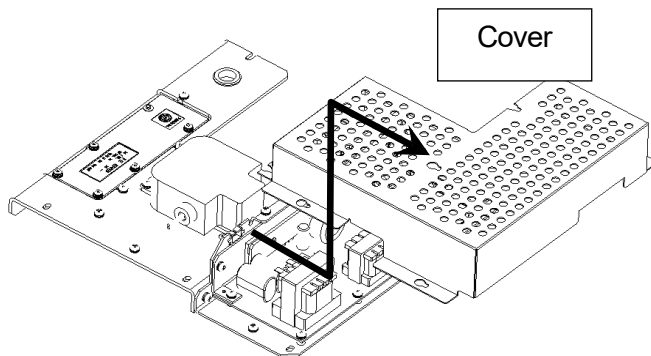

6 **Remove the magnetron cable.**

The magnetron cable is connected to the pulse transformer with two cables (green and yellow).

Remove the cables soldered to the pulse transformer pins. Reuse the protection tube.

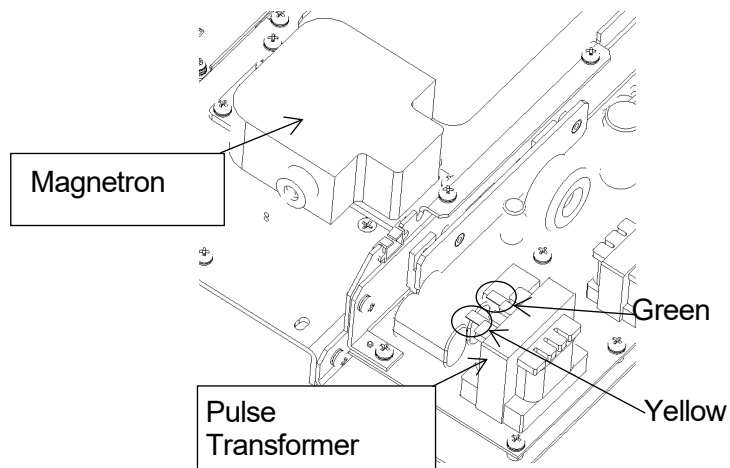

7 Replace the magnetron.

Connect the magnetron cable.

Connect the cables after fixing the magnetron.

Solder the cables to the pulse transformer pins.

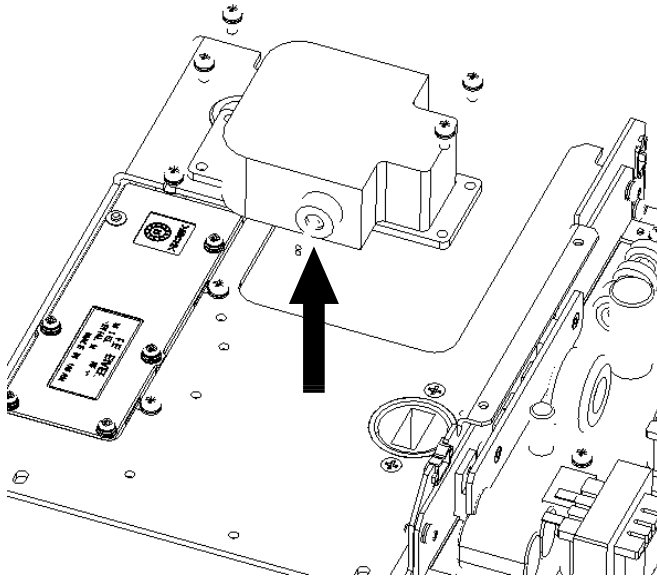

Note:

Use a shielded screw driver.

Touching the magnetron with metal (a tool) causes performance deterioration.

8 Connect the magnetron cable.

Connect the cables after fixing the magnetron.

Solder the cables to the pulse transformer pins.

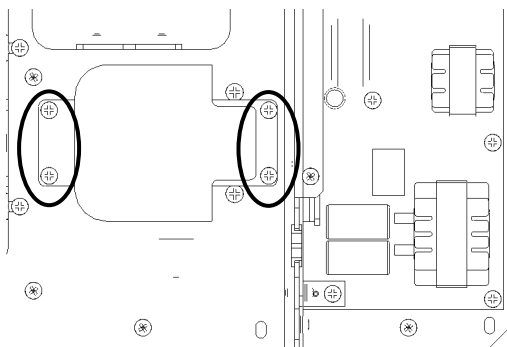

Pass the magnetron cable through the protection tube (reused).

Connect the magnetron cables as follows:

the green cable to No. 16 of the pulse transformer and

the **yellow** cable to No. 15 of the pulse transformer.

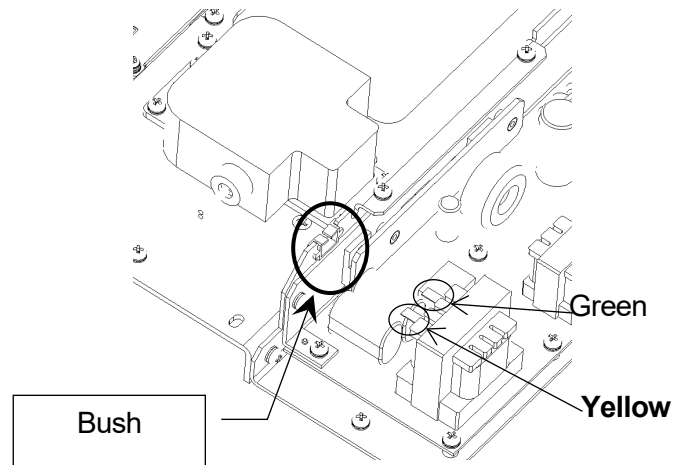

After soldering, place the cables into the bush and attach the cover.

Notes:

- Be careful not to connect cables faultily.
- Adjust the cables for optimal length.
The recommended length is 155 ± 5 mm.
- Use a shielded screw driver.
Touching the magnetron with metal (a tool) causes performance deterioration.

9 Install the transceiver unit into the scanner unit.

Install the transceiver unit into the scanner unit.

When installing the transceiver unit, put the unit inside, then slide it into the joint of the wave guide tube.

Push the transceiver unit wholly so that the unit and the joint of the wave guide tube stick together.

Fix the unit with screws with washer.

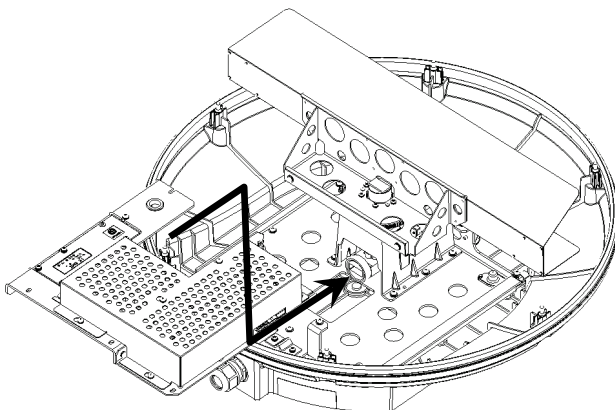

10 Connect the cables to the unit.

Connect the following cables.

- Motor cable: 1 connector
- Receiver cable: 1 connector
- Sensor cable: 1 connector
- Equipment cable: 3 connectors

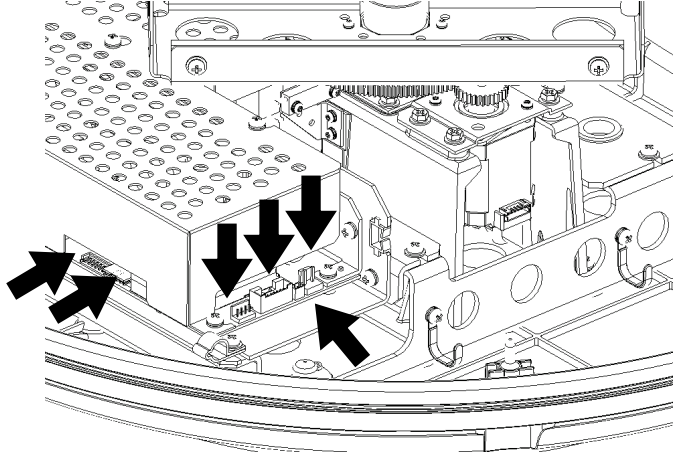

After connecting all cables, check the cables not to interfere the antenna rotation.

11 Attach the radome.

Before attaching the radome, check that the packing has no abnormality, such as deformation or cracks.

Also, remove foreign material and dust if attached.

If any hexagonal bolt is not tightened enough or is loosened, the waterproof performance may be deteriorated. Be sure to tighten all bolts with specified torque (10.5kgf·cm).

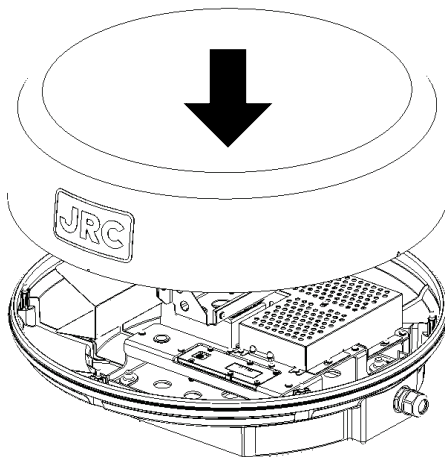

This completes the magnetron replacement procedure.

[Operation check]

After replacement, perform the following operations.

- 1 Turn on the radar, and maintain it in the standby state for 20 to 30 minutes.
- 2 Start transmission in a short pulse range, and gradually change to longer ranges. At this time, open the service engineer menu and perform provisional tuning adjustment.
If operation becomes unstable in the meantime, immediately change the equipment back into the standby state, leave it there for 5 to 10 minutes, and restart transmission.
- 3 After long range transmission for about 15 minutes, open the service engineer menu again and perform tuning adjustment.
In the service engineer menu, perform adjustment for the tune indicator bar on the display to reach 80%.

15.5.2.4 Magnetron replacement procedure for radar antenna NKE-2063A

- 1 **Open the upper housing.**
 - a) Open or close the scanner unit by turning the upper housing (including the antenna) to the bow side.

The gray area shown in the figure below must be clear.

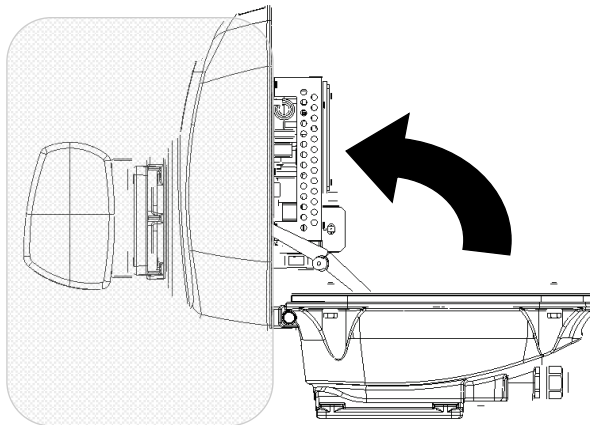

Notes:

- Check if you can open or close safely for work.
 - Be careful with the antenna behavior when opening or closing.
Be careful with the antenna not to hit the mast or platform.
 - Open it slowly. Do not apply too much force to the stay, otherwise, it may break.
-

The upper housing is fixed with 4 M8 hexagonal bolts.

-
- b) Loosen those hexagonal bolts.
(Bolts are falling-out prevention bolts.)

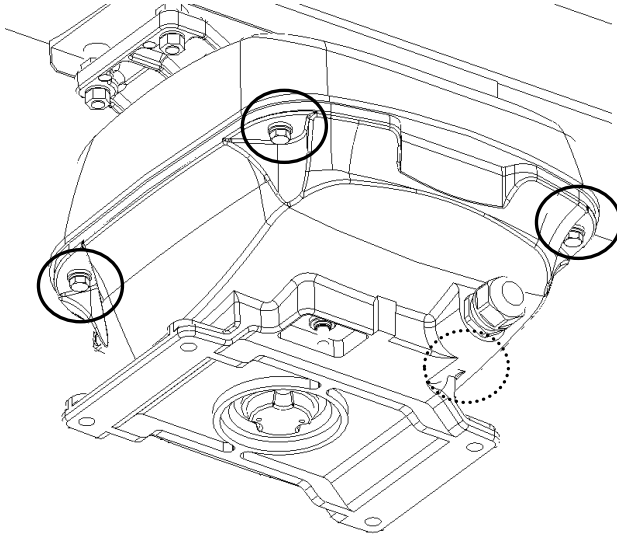

- c) Open the upper housing by rotating upward to the bow side.

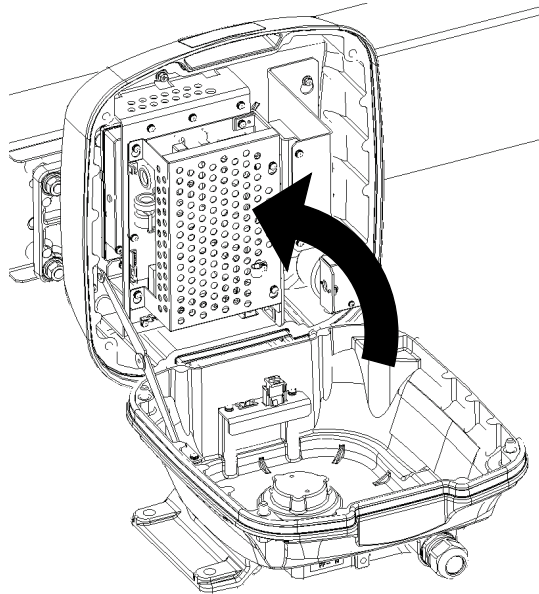

2 Remove the transceiver unit.

The transceiver unit is installed in the port side of the scanner.

Remove each cable connected to the transceiver unit.

Remove the equipment cable.

Remove the motor cable.

Remove the sensor cable.

Remove the safety switch cable.

The transceiver unit is fixed with 4 upset head bolts with washer (M5X16SUS_SW_W) and 2 upset head bolts with washer (M4X10SUS_SW_W). Loosen those bolts.

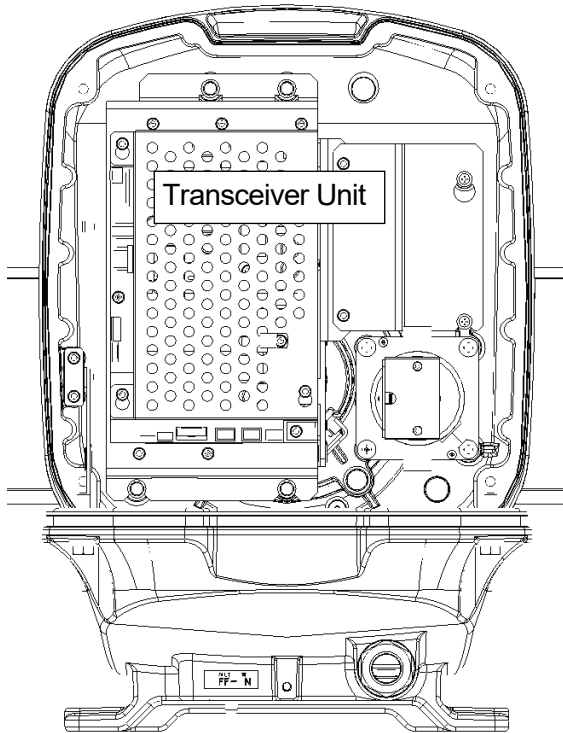

3 Remove the transceiver unit.

Remove the transceiver unit.

When removing the transceiver unit, once slide it to upper direction and pull it off.

Perform the replacement of circuits within the transceiver unit in a safe place.

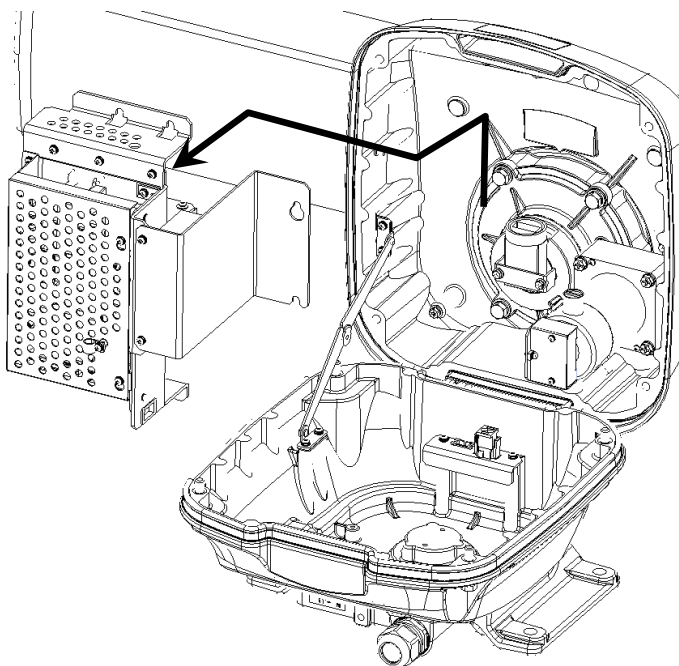

4 Remove the cover of the transceiver unit.

Perform the replacement of circuits and parts within the transceiver unit.

Remove the cover of the transceiver unit.

The cover is fixed with 4 built-in M4X10Bs_SW_LW screws.

Loosen all screws and slide the cover to remove it.

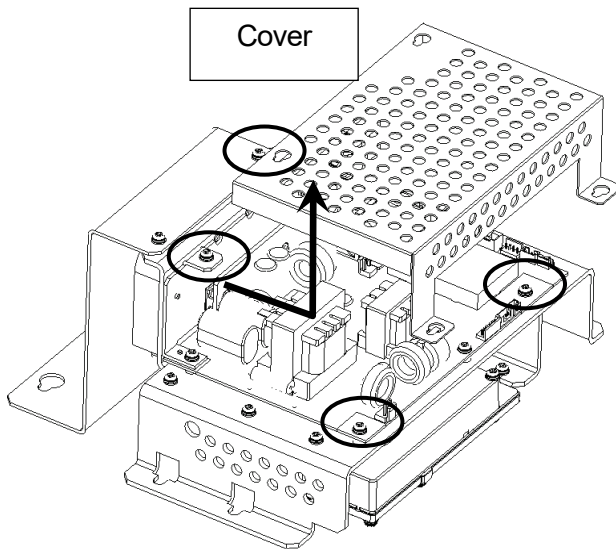

5 Remove the support plate of the transceiver unit.

The support plate is fixed with 2 screws with washer (M4X10Bs_SW_LW).

Remove all screws and slide the support plate to remove it.

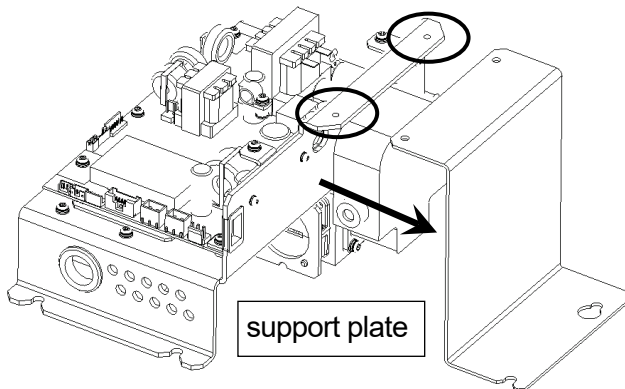

Cover and support plate removed

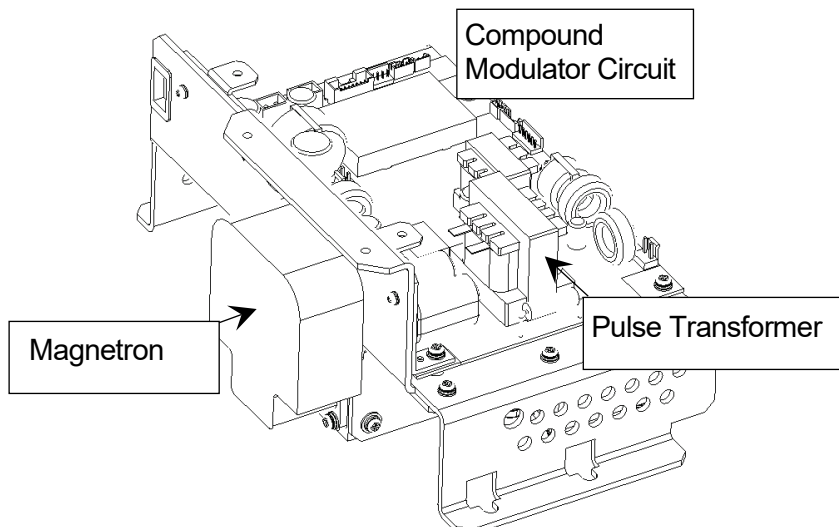

6 **Remove the magnetron cable.**

The magnetron cable is connected to the pulse transformer with two cables (green and yellow).
Remove the cables soldered to the pulse transformer pins.
Reuse the protection tube.

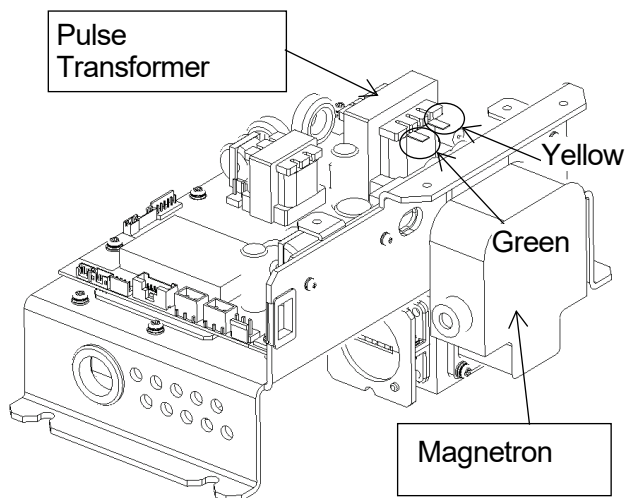

7 **Replace the magnetron.**

The magnetron is fixed with 4 built-in M4X10Bs_SW_LW screws. Loosen the screws and replace the magnetron.

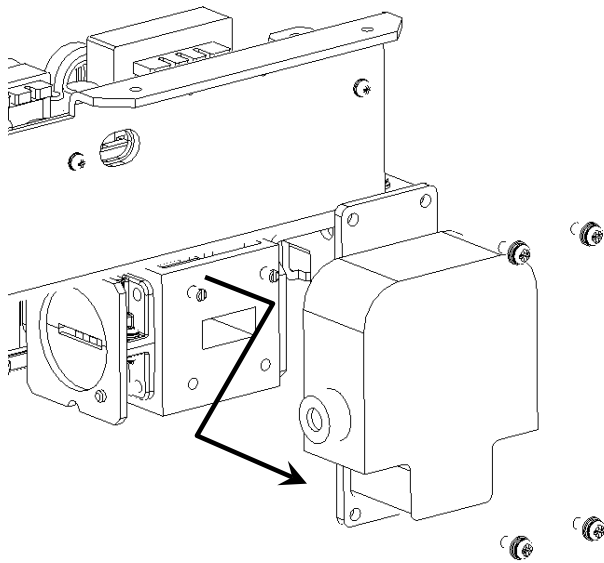

Note:

Use a shielded screw driver.

Touching the magnetron with metal (a tool) causes performance deterioration.

8 Connect the magnetron cable.

Connect the cables after fixing the magnetron.

Solder the cables to the pulse transformer pins.

Pass the magnetron cable through the protection tube (reused). Pass the cable through the elongate hole of the chassis.

Connect the magnetron cables as follows:

the green cable to No. 16 of the pulse transformer and

the yellow cable to No. 15 of the pulse transformer.

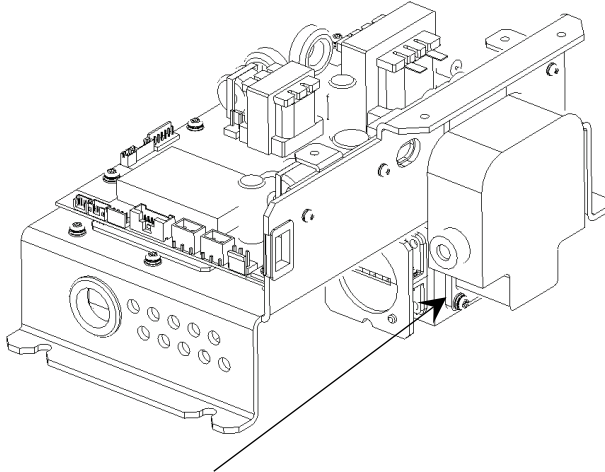

After replacement, check that the magnetron is steady.

Notes:

- Be careful not to connect cables faultily.
- Adjust the cables for optimal length.
 - The recommended length of green cable is 175 ± 5 mm.
 - The recommended length of yellow cable is 175 ± 5 mm.
- Touching the magnetron with metal (a tool) causes performance deterioration.

9 Set up the transceiver unit.

Attach the cover and the support plate to the transceiver unit.

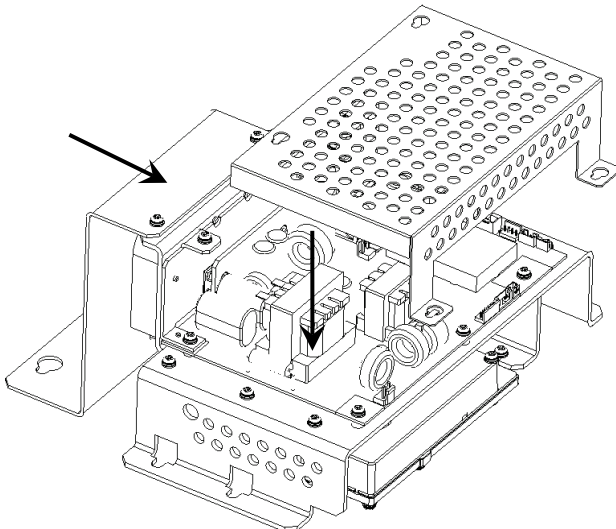

10 Install the transceiver unit.

Install the transceiver unit into the scanner unit.

When installing the transceiver unit, put the unit inside, then slide it into the joint of the wave guide tube.

Push the transceiver unit wholly so that the unit and the joint of the wave guide tube stick together.

Fix the unit with bolts with washer.

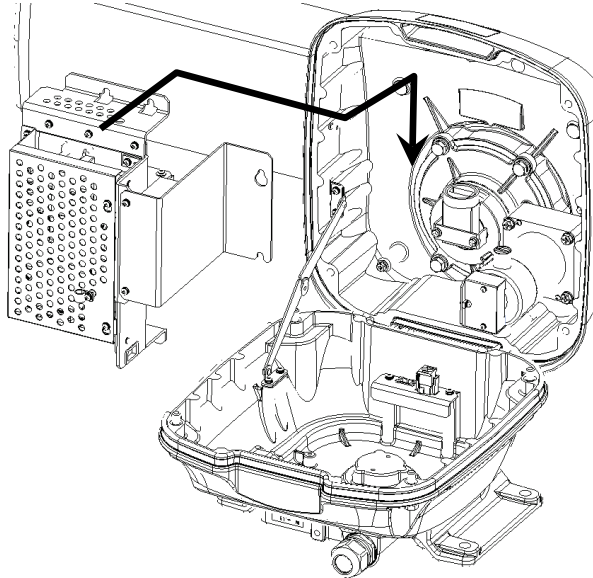

11 Close the upper housing.

Before closing the upper housing, check that the packing has no abnormality, such as deformation or cracks.

Also, remove foreign material and dust if attached.

Close the upper housing while pulling the center of the stay

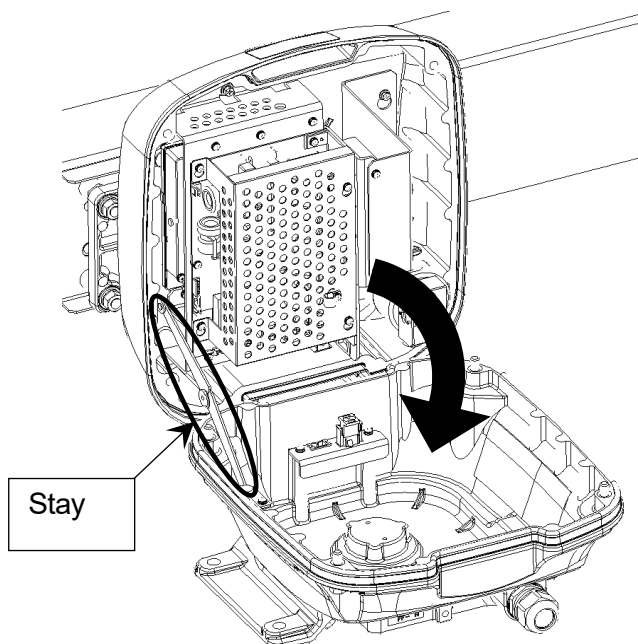

If any hexagonal bolt is not tightened enough or is loosened, the waterproof performance may be deteriorated. Be sure to tighten all bolts with specified torque (120 to 150kgf·cm).

Notes:

- When closing the housing, be careful that the cables are not caught.
 - When closing the upper housing, always pull the center of the stay. Otherwise the stay may be broken.
-

After the work, turn "ON" the safety switch.

This completes the magnetron replacement procedure.

[Operation check]

- 1 Turn on the radar, and allow sufficient preheating time (about 20 to 30 minutes in the STBY state).
- 2 Start transmission in a short pulse range, and gradually change to longer ranges. At this time, open the service engineer menu and perform provisional tuning adjustment. If operation becomes unstable in the meantime, immediately change the equipment back into the STBY state, leave it there for 5 to 10 minutes, and restart transmission.
- 3 After long range transmission for about 15 minutes, open the service engineer menu again and perform tuning adjustment.
In the service engineer menu, perform adjustment for the tune indicator bar on the display to reach 80%.
In the service engineer menu, also confirm that the magnetron current indicator shows 50 to 70%.

15.5.2.5 Magnetron replacement procedure for radar antenna NKE-2103

- 1 Turn Off the safety switch of the radar antenna.

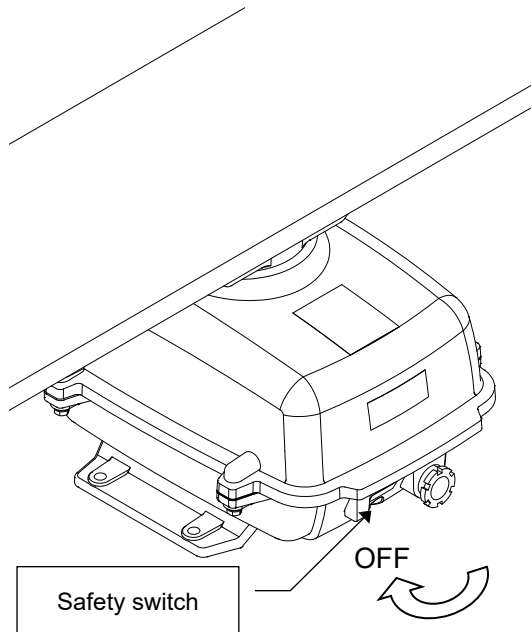

⚠ When replacing a magnetron, ensure that the safety switch of the radar antenna is turned Off prior to commencing the replacement work.

The safety switch is located on the rear bottom part of the radar antenna.

Turn Off the safety switch.

- 2 Remove the bolts and open the upper cover.

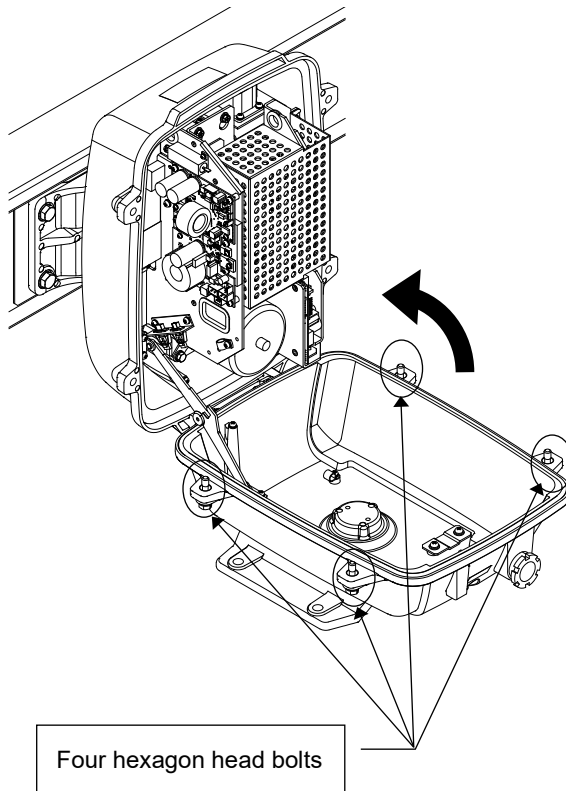

The upper cover is secured in place with hexagon head bolts (M8, designed to be protected from falling out) at four positions.

After removing the bolts, open the upper cover until the stay metal fitting stopper works.

* Closing the upper cover
Release the stay metal fitting stopper,
and then close the upper cover.

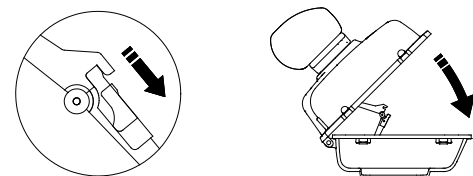

3 Remove the cable.

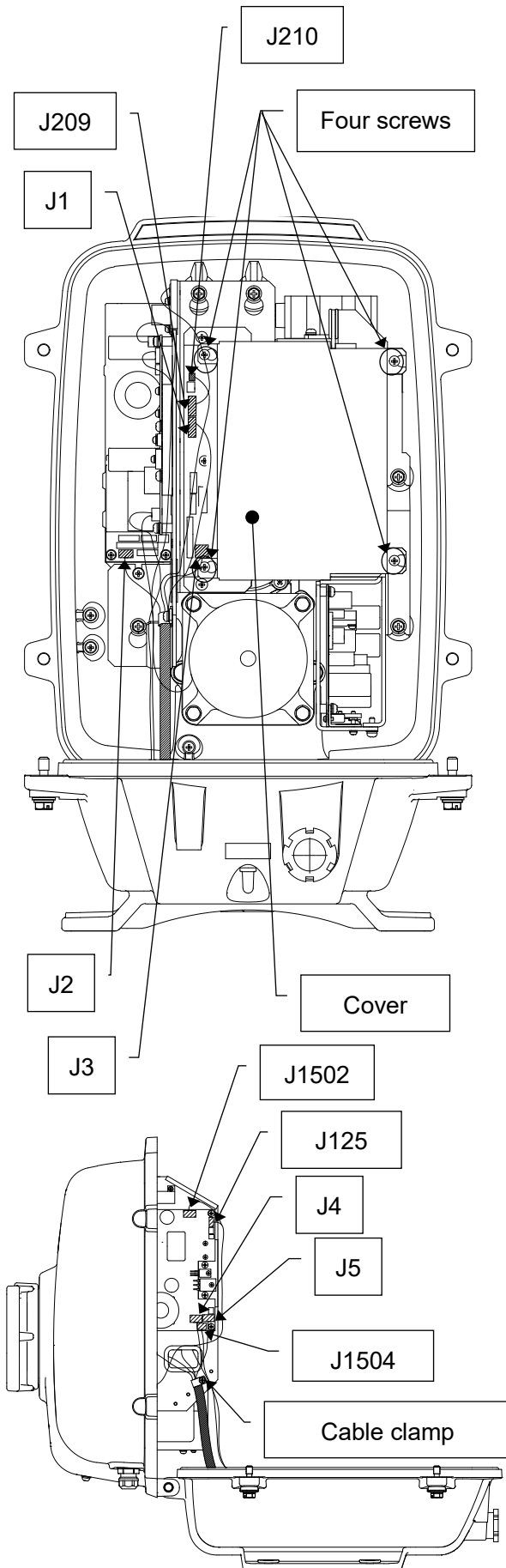

Loosen four screws (M4×12).

Slide the cover to the left, and then remove it.

Remove one connector of the encoder. (J209)

Remove five connectors of the installed cable. (J1 to J5)

Remove two connectors of the safety switch. (J210 and J1504)

Remove two connectors of the motor. (J1502 and J125)

Remove 10 connectors in total.

Remove one screw (M4×10) and remove the cable clamp.

4 Remove the transmitter-receiver unit.

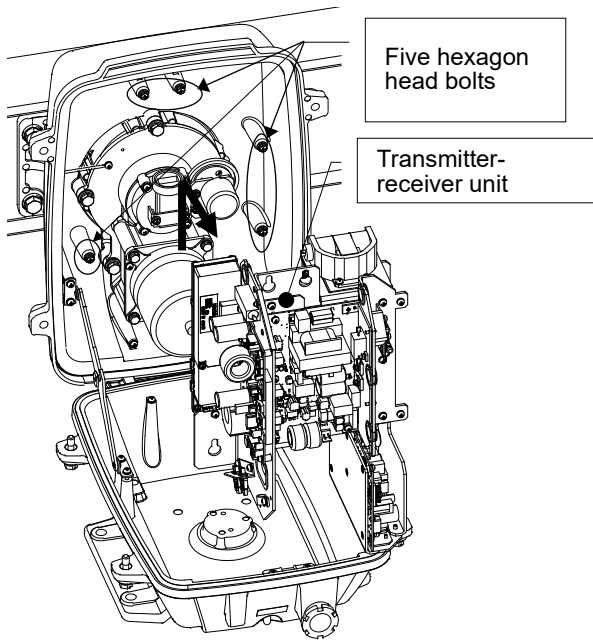

Loosen five hexagon head bolts (M5×16).

Slide the transmitter-receiver unit to the upper side, and then remove it.

5 Replace the magnetron.

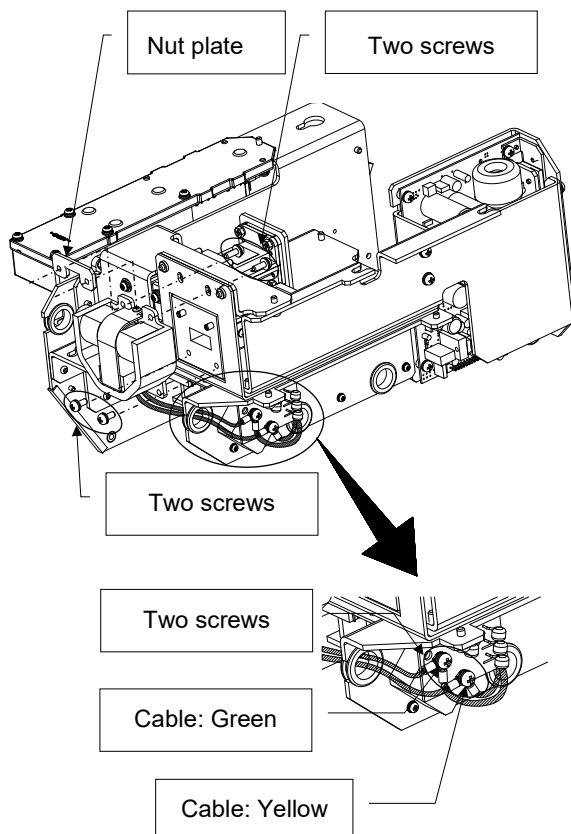

Remove two screws (M4×10), and remove the magnetron cable.

! Use a shielded screwdriver for this work. Contact with metal (tools) can cause performance degradation in the magnetron.

Remove four screws (M4) in total on the front and rear of the magnetron, and remove the magnetron.

Use caution not to lose the nut plate.

Secure the replacement magnetron.

Pay attention to the position (yellow and green) where magnetron and pulse transformer cables are secured.

After replacing the magnetron, reassemble the unit by following the same steps in reverse order. Do not forget to tighten the bolts and screws, and do not forget to reconnect the cables. Turn On the safety switch and confirm if the equipment operates properly.

The above steps complete the magnetron replacement procedure.

15.5.2.6 Magnetron replacement procedure for radar antenna NKE-2255

- 1 Turn Off the safety switch of the radar antenna.

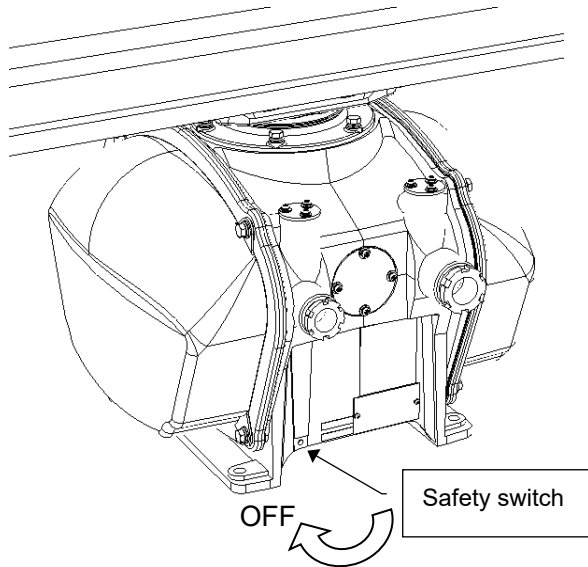

⚠ When replacing a magnetron, ensure that the safety switch of the radar antenna is turned Off prior to commencing the replacement work.

The safety switch is located on the rear bottom part of the radar antenna. Turn Off the safety switch.

- 2 Remove the cover.

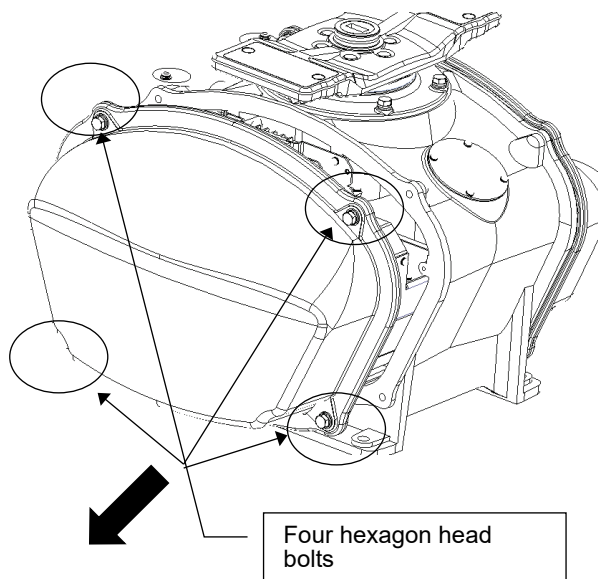

The magnetron is incorporated on the right side (starboard side) of the radar antenna. Remove the cover on the right side.

The cover is secured in place with hexagon head bolts (M8, designed to be protected from falling out) at four positions.

Place the removed cover in a safe area. Exercise care to avoid dust or other foreign matters adhering to the packing.

3 Replace the magnetron.

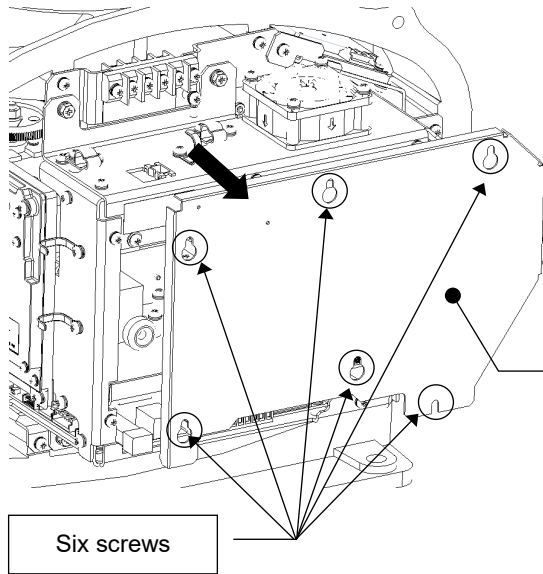

Remove the front cover from the transmitter-receiver unit.
Loosen six front cover screws (M4×10).
Slide the front cover to the upper side, and then remove it.

Front cover of transmitter-receiver unit

Six screws

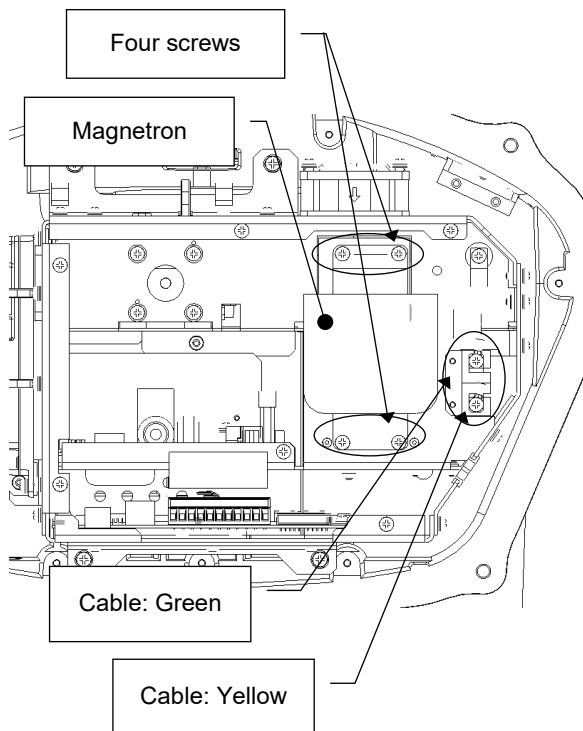

Remove two screws (M4×10), and remove the magnetron cable.

! Use a shielded screwdriver for this work. Contact with metal (tools) can cause performance degradation in the magnetron.

Remove four screws (M4×10), and remove the magnetron.
Use caution not to lose the screws after removing them.

Install a replacement magnetron and cables.

! Affix the removed insulating tube to the new magnetron to be installed.
(Recycle this insulating tube. Do not use the accessory corrugated tube into the new magnetron.)

After replacing the magnetron, reassemble the unit by following the same steps in reverse order. Do not forget to tighten the bolts and screws, and do not forget to reconnect the cables.

The above steps complete the magnetron replacement procedure.

15.5.3 Replacing the motor

Memo

Replacement of motor must be made by specialized service personnel.

For details, refer to Service Manual.

After replacement, connect the lead wire correctly.

15.5.3.1 Motor replacement procedure for radar antenna NKE-1130/A

- 1 Turn Off the safety switch of the radar antenna.

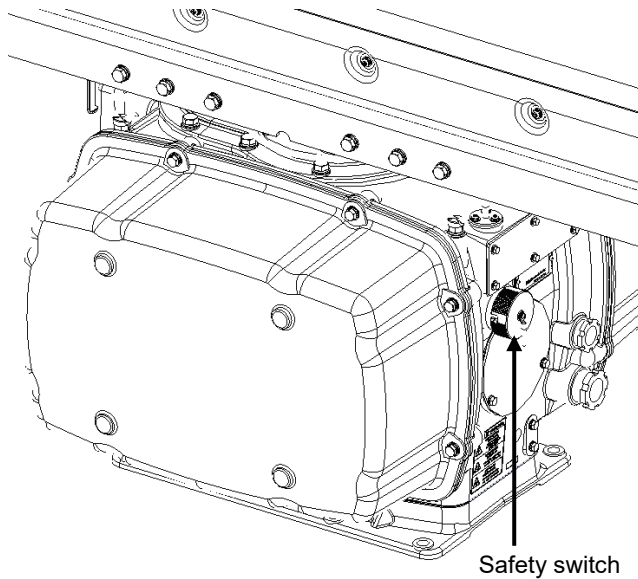

When replacing a motor, ensure that the safety switch of the radar antenna is turned Off prior to commencing the replacement work.

The safety switch is located on the rear (stern) side of the radar antenna.

Remove the cover and turn Off (to the lower side) the safety switch.

Remove the cover.

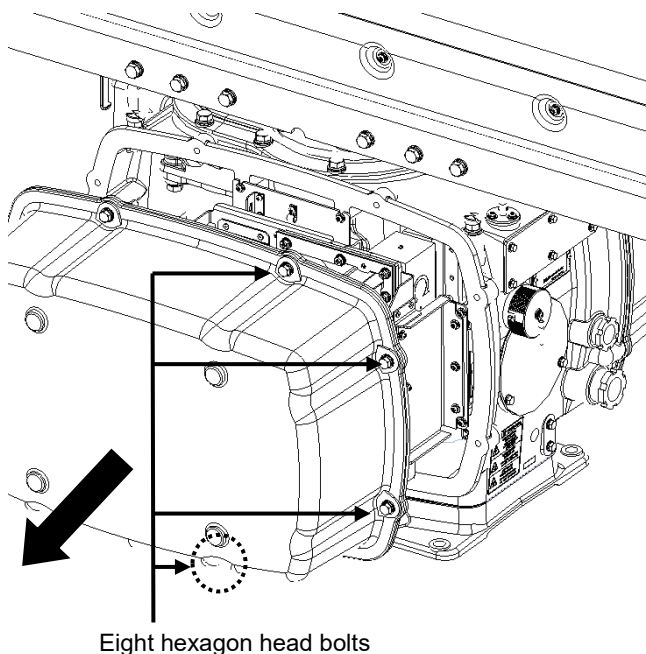

The motor is mounted on the front side (head side) of the radar antenna. Both left and right side covers need to be removed to carry out the motor replacement work.

The cover is secured in place with hexagon head bolts (M8, designed to be protected from falling out) at eight positions.

After removing the cover, place it in a safe area.

Exercise care to avoid dust or other foreign matters adhering to the packing.

Remove the motor cable.

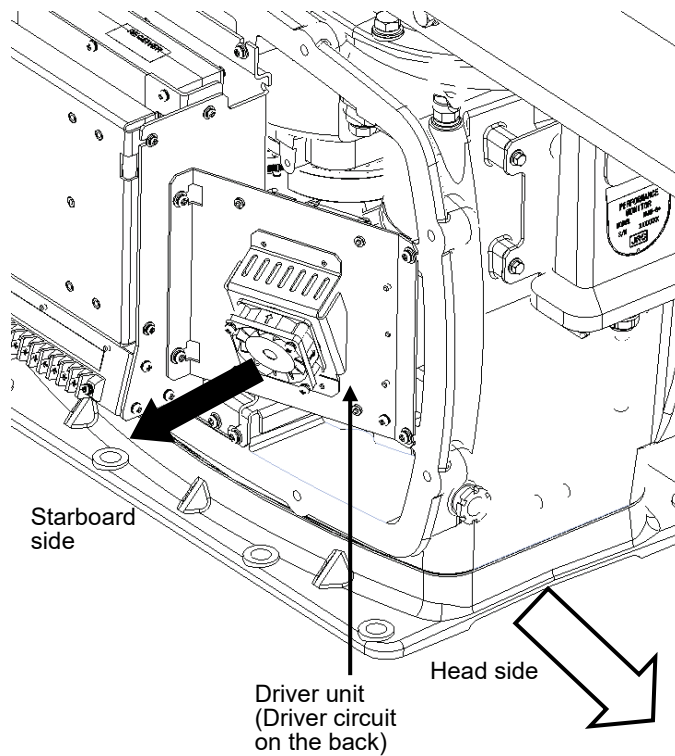

The motor driver unit is located on the right side (starboard side).

The motor driver is secured in place with screws (M5×12) at four positions.

Demount the motor driver unit and detach the motor cables connected to the driver circuit on the back of the driver unit.

Replace the motor.

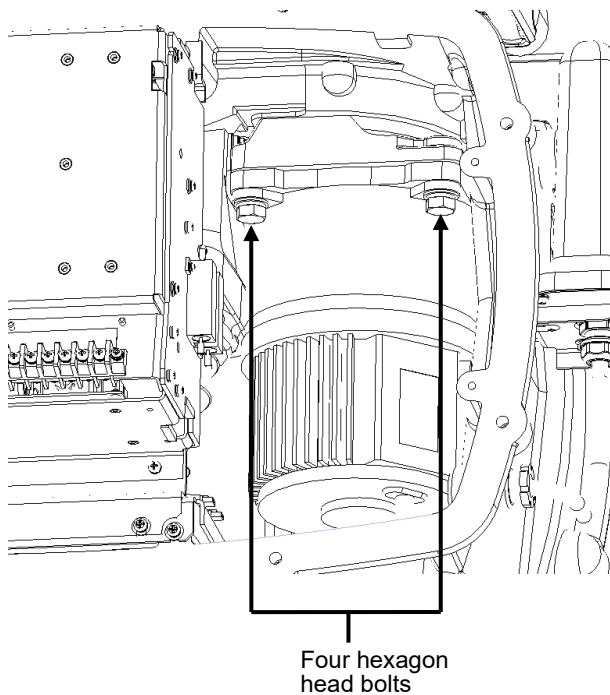

The motor is secured in place with hexagon head bolts (M10×40, SW10 and W10) at four positions.

Remove the four hexagon head bolts.



The weight of the motor is about 10 kg.

Use due caution when undertaking this procedure.

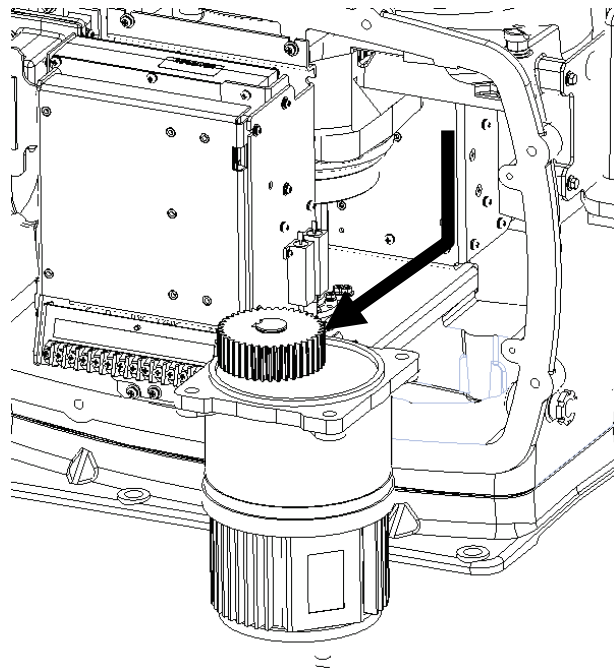

Remove the motor.

Apply grease to the gear wheel of the new motor.

Install the new motor in the radar antenna.

Fasten the hexagon head bolts with proper torque (350 kgf·cm) to ensure that none of the bolts is left without being tightened or tightened too loosely.

Connect the motor cables.

Connect each cable back to its original position on the motor driver circuit.

Install the cover.

Before installing the cover on the radar antenna, check to confirm that there are no deformations, cracks or other abnormalities in the packing of the cover. Remove any foreign matters, dust or other contaminants if found.

Leaving any hexagon head bolts without tightened, or tightening them too loosely, may result in the waterproof performance of the radar antenna being adversely affected. Fasten the hexagon head bolts with proper torque to ensure that none of the bolts is left without being tightened or tightened too loosely.

When the motor replacement is complete, turn on the safety switch of the radar antenna and check if the equipment operates properly.

15.5.3.2 Motor replacement procedure for NKE-1632/A

1 Remove the cover.

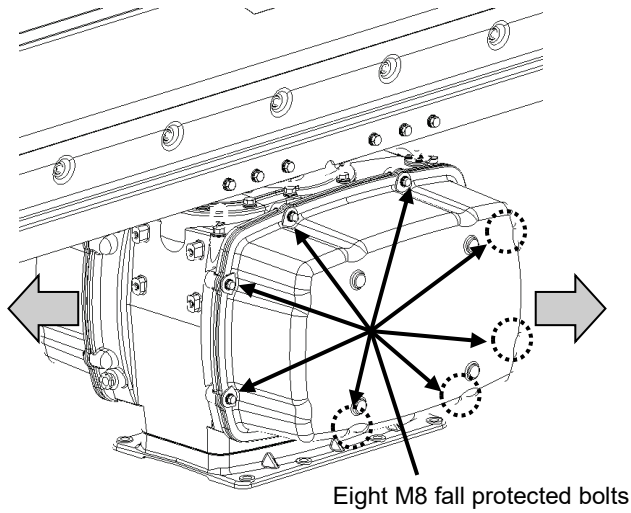

 When replacing a motor, ensure that the safety switch of the radar antenna is turned Off prior to commencing the replacement work.

 Exercise care not to lose bolts, screws and other parts removed from the radar antenna, as they will be used again in later steps.

Both left and right side covers need to be removed to carry out the motor replacement work.

Loosen the M8 bolts designed to be protected from falling out at eight positions, and remove the cover.

Replace the motor.

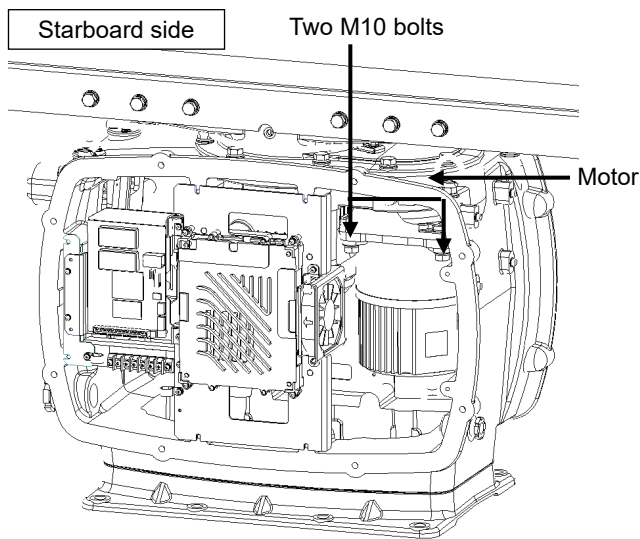

[Starboard side]

Unscrew the M10 bolts at two positions.

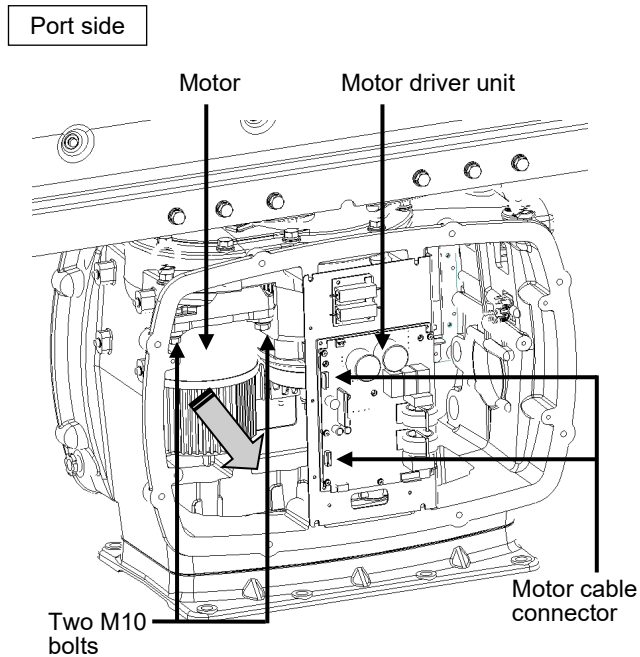

[Port side]

Detach the motor cables connected to the motor driver.

Remove the M10 bolts at two positions and pull the motor carefully to demount it.

Apply grease to the gear wheel of the replacement motor prior to installation.

Install the new motor in the radar antenna.

Fasten the hexagon head bolts with proper torque (350 kgf·cm) to ensure that none of the bolts is left without being tightened or tightened too loosely.

Install the cover by following the same steps in reverse order.

Turn On the safety switch and confirm if the equipment operates properly.

15.5.3.3 Motor replacement procedure for NKE-2632/A, NKE-2632-H

- 1 Remove the cover.

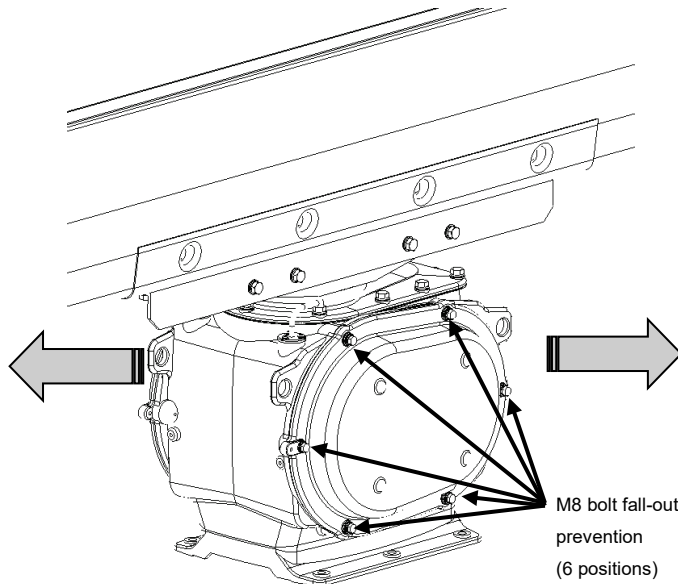

⚠ When replacing a motor, ensure that the safety switch of the radar antenna is turned Off prior to commencing the replacement work.

⚠ Exercise care not to lose bolts, screws and other parts removed from the radar antenna, as they will be used again in later steps.

Both left and right side covers need to be removed to carry out the motor replacement work.

Remove the M8 fall-out prevention bolts (6 positions) and remove the cover.

2 (Port side) Detach the motor cable.

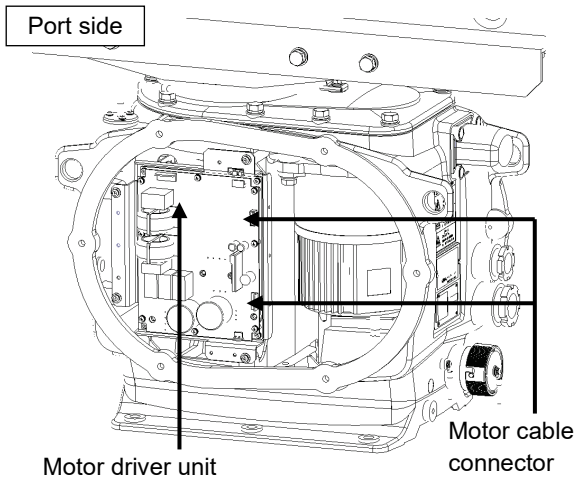

[Port side]
Detach the motor cables
connected to the motor driver.

(Port side) Detach the motor cable. * In case of NKE-2632-H

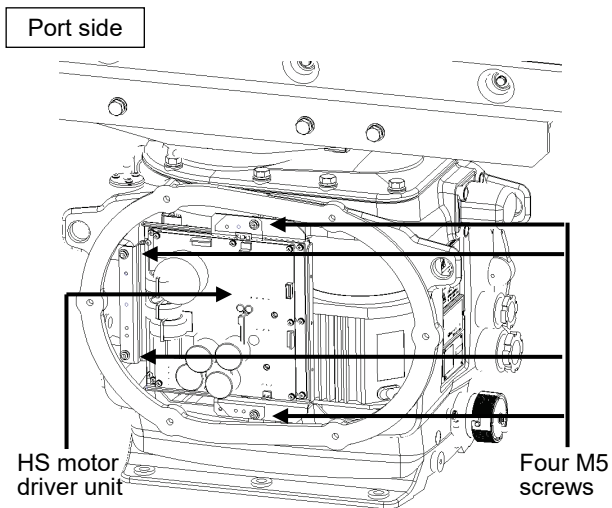

* In case of NKE-2632-H
Demount the HS motor driver unit.

[Port side]
Detach the cables connected to the
HS motor driver unit.

Remove the M5 screws at four
positions and demount the motor
driver unit.

(Starboard side) Open the power IF circuit unit.

Starboard side

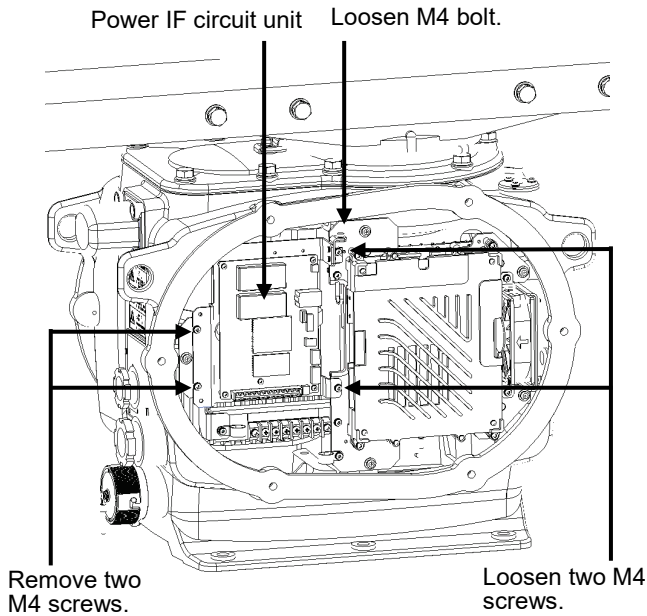

[Starboard side]

The power IF circuit unit can be opened to the near side by loosening the M4 bolts and two M4 screws while removing the other two M4 screws.

Starboard side

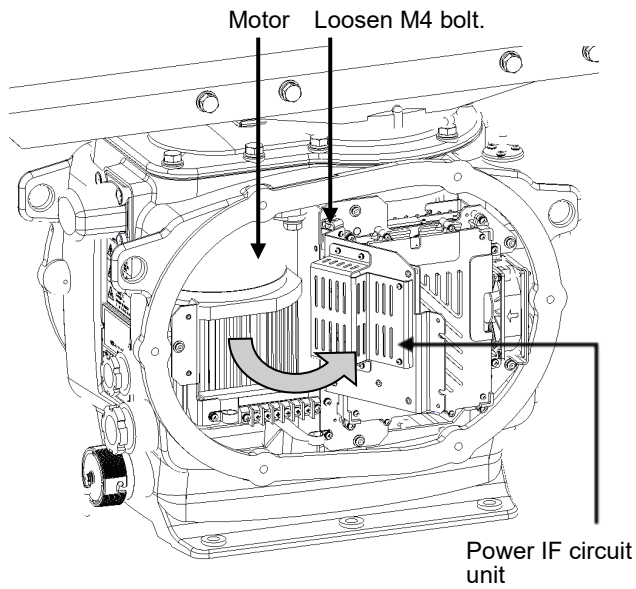

Loosen the M4 bolt and fix the power IF circuit unit with the unit open.

Replace the motor.

Starboard side

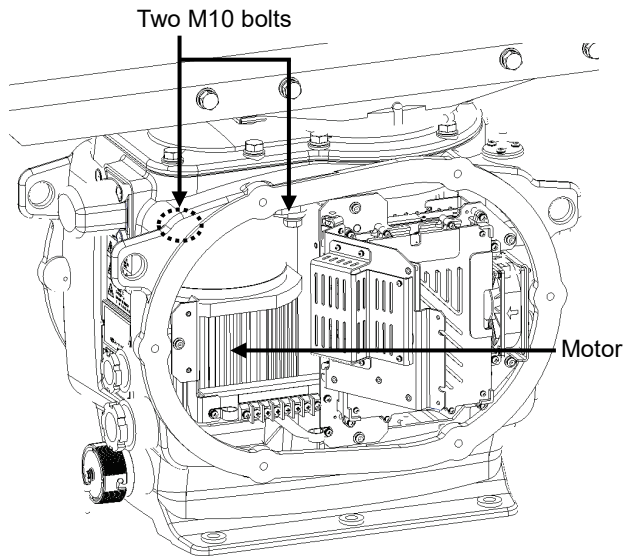

[Starboard side]

Remove the M10 bolts at two positions.

Port side

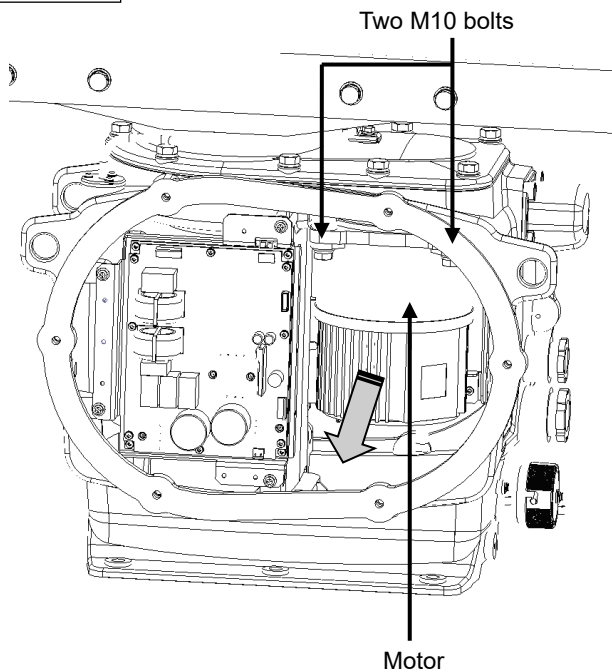

[Port side]

Remove the M10 bolts at two positions and pull the motor to demount it.

Apply grease to the gear wheel of the replacement motor prior to installation.

Install the new motor in the radar antenna.

Fasten the hexagon head bolts with proper torque (350 kgf·cm) to ensure that none of the bolts is left without being tightened or tightened too loosely.

Install the cover by following the same steps in reverse order.

Turn On the safety switch and confirm if the equipment operates properly.

15.5.3.4 Motor replacement procedure for NKE-2043

1. Remove the motor cable.

The motor unit is installed on the bow side of the scanner.

Remove the motor cable.

Remove the cable from the connector on the side of the motor unit.

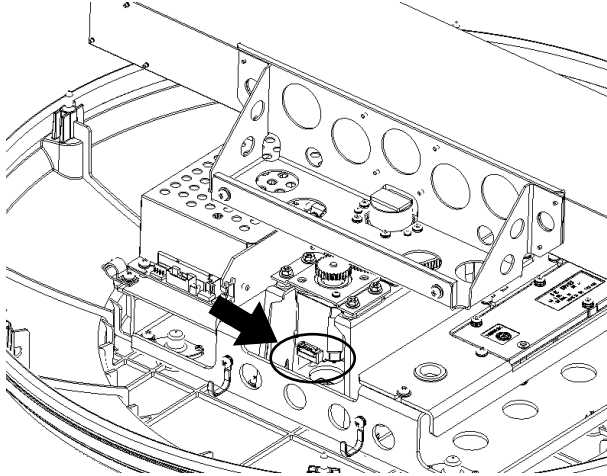

2. Remove the motor unit.

The motor unit is fixed with

4 upset head bolts with washer (M4X12SUS_SW_W).

Remove the upset head bolts to remove the motor unit.

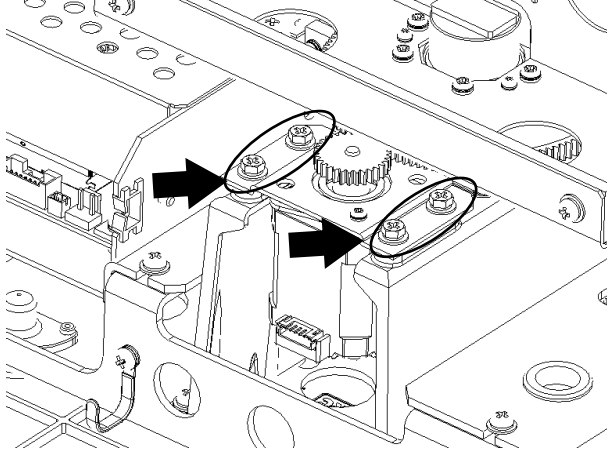

3. Replace the motor.

The motor is fixed with 2 screws with washer (M3X6Bs_SW).

a) Remove 2 screws.

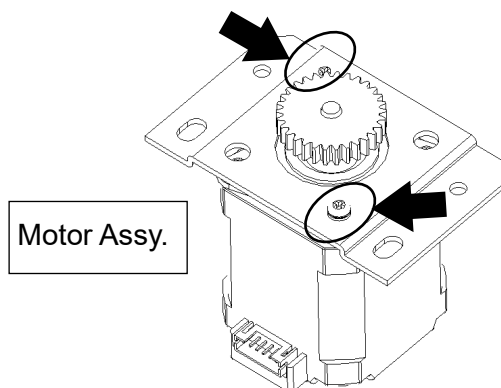

-
- b) Remove the motor for replacement.

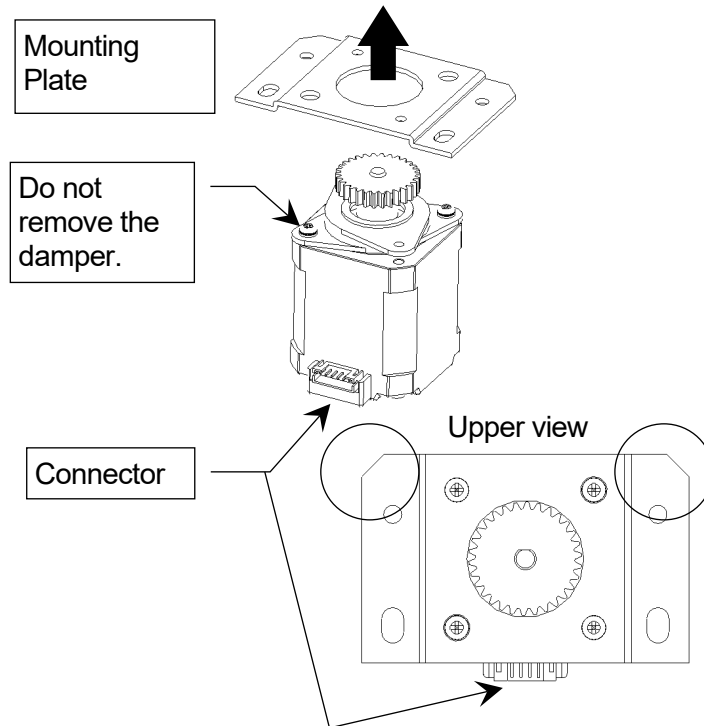

Note:

- Pay attention to the orientation of the motor.
For installation, pay attention to the orientation of the mounting plate and the motor (connector positions).
The motor connector is positioned in reverse to the chamfer of the mounting plate.
-

- c) Install the motor into the scanner.
Be sure to tighten all the upset head bolts with specified torque.
Connect the motor cable to the connector on the motor.
After connection, check the cables not to interfere the antenna rotation.

Apply grease to the gear after installing the motor.

4. Attach the radome.

Before attaching the radome, check that the packing has no abnormality, such as deformation or cracks.

Also, remove foreign material and dust if attached.

If any hexagonal bolt is not tightened enough or is loosened, the waterproof performance may be deteriorated. Be sure to tighten all bolts with specified torque (10.5kgf·cm).

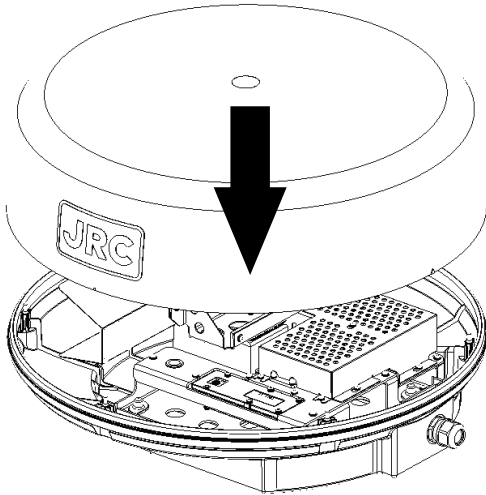

This completes the motor replacement procedure.

[Operation check]

After replacement, perform the following operations.

Turn on the radar, transmit radar signals when the countdown is finished, and check that radar images are displayed normally.

When starting the motor rotation, check if no abnormal noise will be emitted when it is running, or when it stops.

15.5.3.5 Motor replacement procedure for NKE-2063A

1 Remove the motor unit.re displayed normally.

The motor unit is installed in the starboard bow side (starboard lower side when opened) of the scanner.

Remove the motor cable.

Remove the connectors of the cables connected to the transceiver unit.

The motor is fixed with 4 upset head bolts (M6X45FE) and spring washers (SW6).

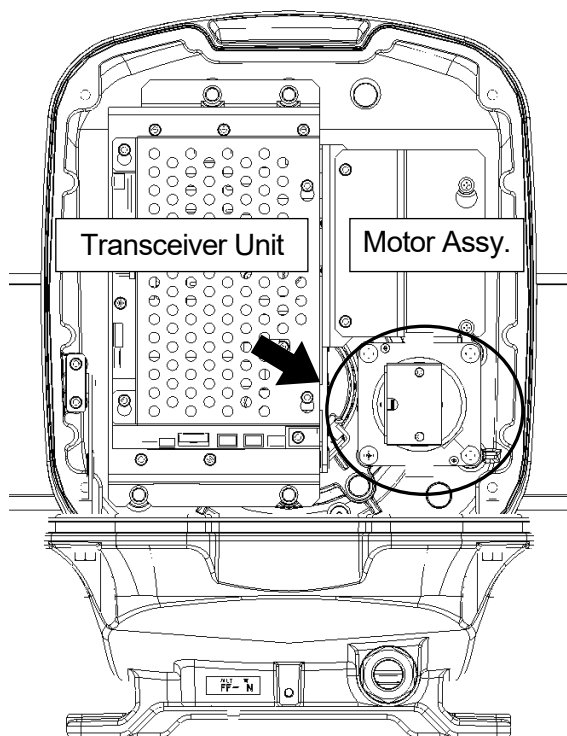

2 Replace the motor unit.

Replace the motor unit.

Apply grease to the gear when installing the motor unit.

In addition, pay attention to the gear engagement when installing.

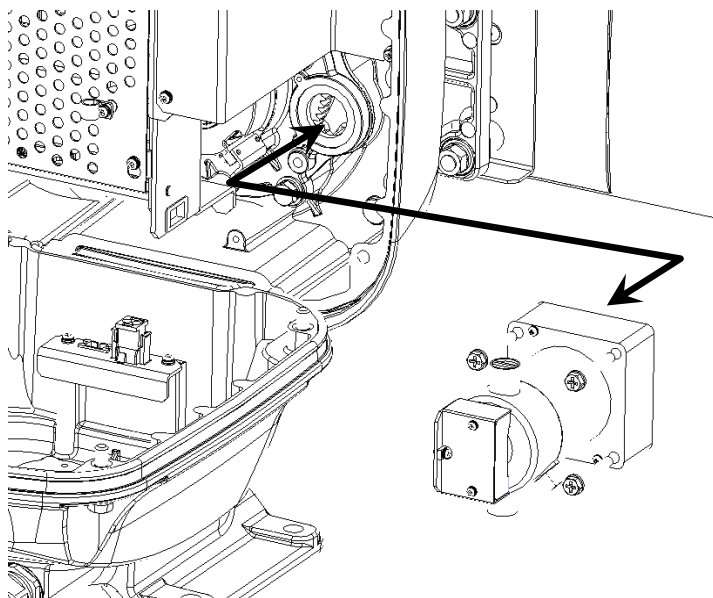

Note:

Do not forcibly install the motor. Otherwise, the gear may be damaged. If the motor cannot be installed easily, we recommend to rotate the antenna several times.

3 Close the upper housing.

Before closing the upper housing, check that the packing has no abnormality, such as deformation or cracks.

Also, remove foreign material and dust if attached.

Close the upper housing while pulling the center of the stay.

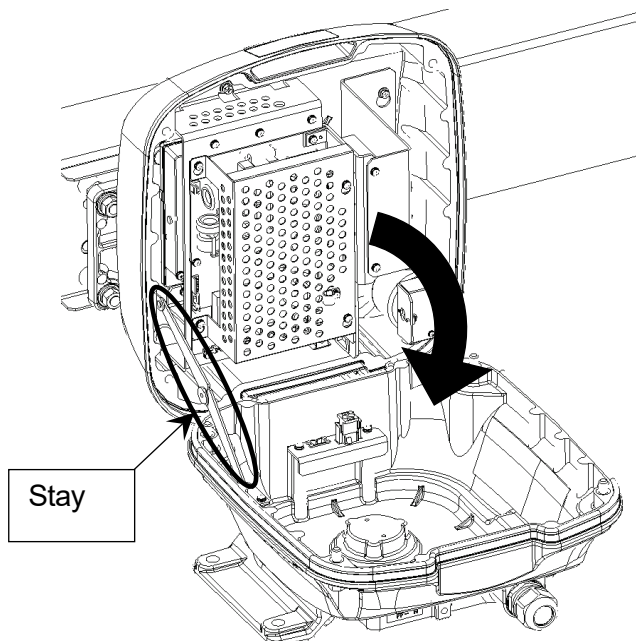

If any hexagonal bolt is not tightened enough or is loosened, the waterproof performance may be deteriorated. Be sure to tighten all bolts with specified torque (120 to 150kgf·cm).

After the work, turn "ON" the safety switch.

Notes:

- When closing the housing, be careful that the cables are not caught.
 - When closing the upper housing, always pull the center of the stay. Otherwise the stay may be broken.
-

This completes the motor replacement procedure.

-
- 4 Turn on the radar, transmit radar signals when the countdown is finished, and check that radar images are displayed normally.
 - 5 There shall be no abnormal noise emitted when the motor starts running, when it is running, or when it stops.

[Operation check]

After completing the replacement work, check the operation by following the procedure below.

Turn on the radar, transmit radar signals when the countdown is finished, and check that radar images are displayed normally. There shall be no abnormal noise emitted when the motor starts running, when it is running, or when it stops.

15.5.3.6 Motor replacement procedure for NKE-2103-4/4HS/6/6HS

- 1 Turn Off the safety switch of the radar antenna.

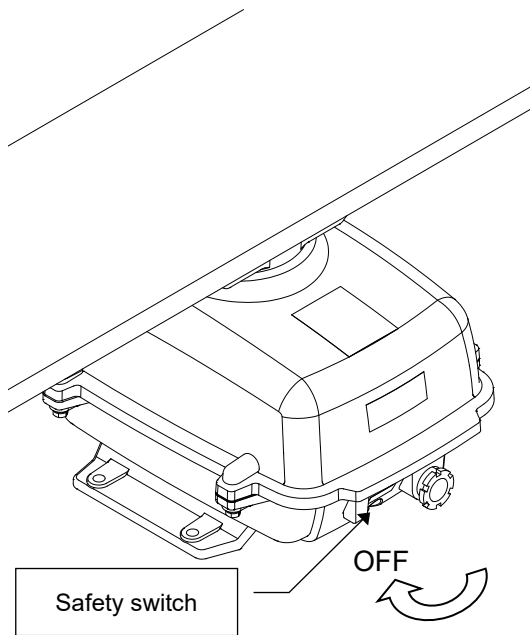

⚠ When replacing a motor, ensure that the safety switch of the radar antenna is turned Off prior to commencing the replacement work.

The safety switch is located on the rear bottom part of the radar antenna.
Turn Off the safety switch.

- 2 Remove the bolts and open the upper cover.

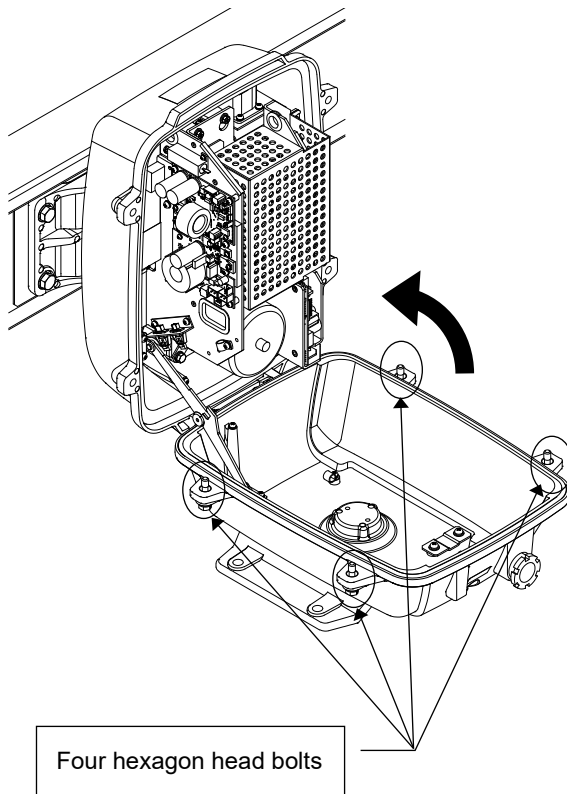

The upper cover is secured in place with hexagon head bolts (M8, designed to be protected from falling out) at four positions.

After removing the bolts, open the upper cover until the stay metal fitting stopper works.

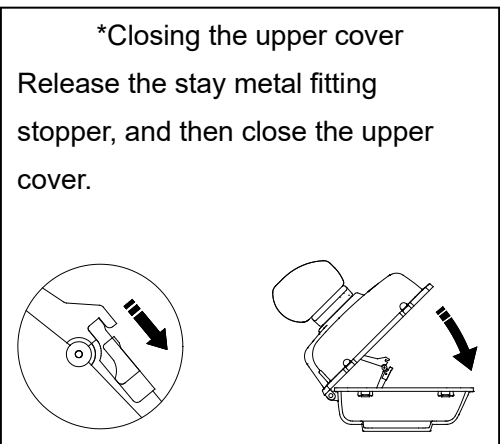

3 Remove the cable.

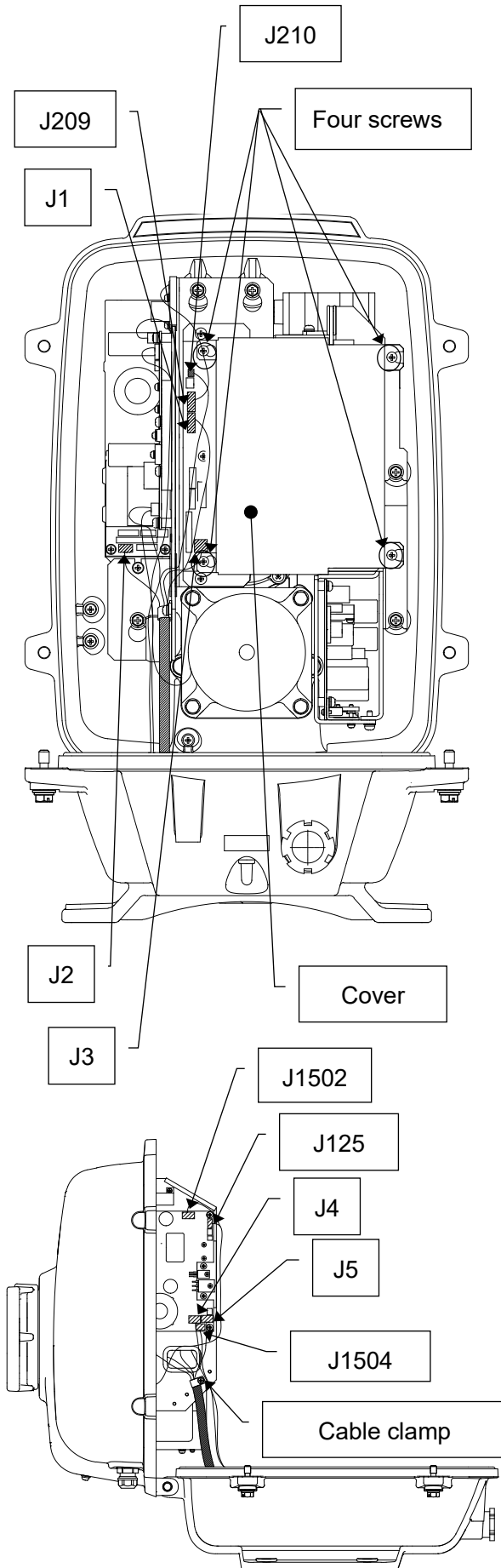

Loosen four screws (M4×12).

Slide the cover to the left, and then remove it.

Remove one connector of the encoder. (J209)

Remove five connectors of the installed cable. (J1 to J5)

Remove two connectors of the safety switch. (J210 and J1504)

Remove two connectors of the motor. (J1502 and J125)

Remove 10 connectors in total.

Remove one screw (M4×10) and remove the cable clamp.

4 Remove the transmitter-receiver unit.

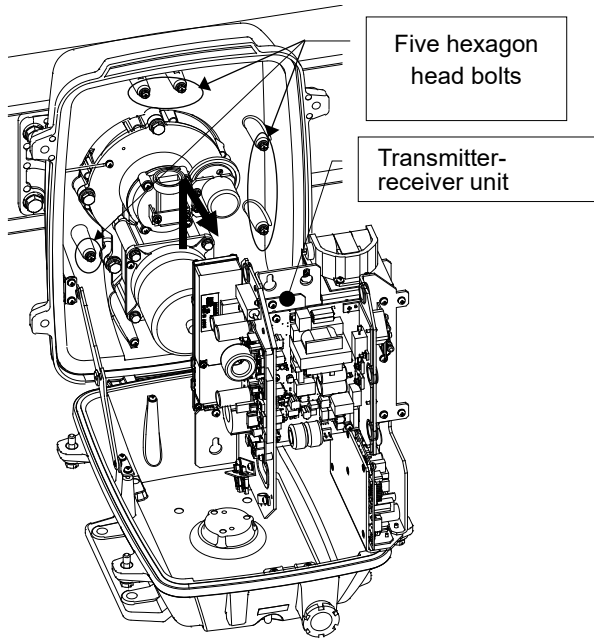

Loosen five hexagon head bolts (M5×16).

Slide the transmitter-receiver unit to the upper side, and then remove it.

5 Replace the motor.

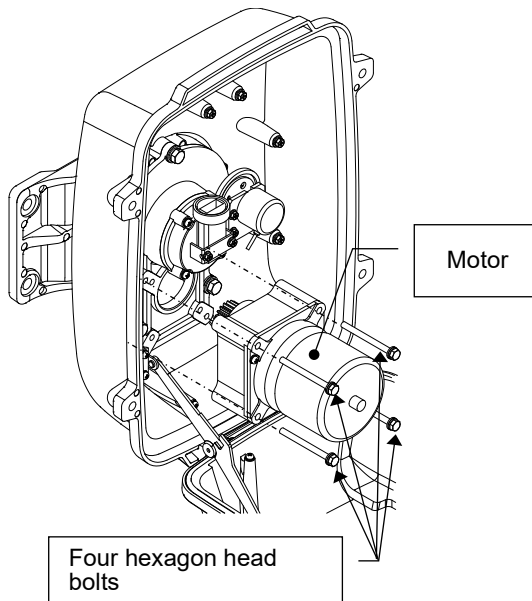

Remove four hexagon head bolts (M6×70), and remove the motor.

Apply grease to the replacement motor gears, and secure the motor with four bolts.

Tighten the hexagon head bolts at a torque of (72 kgf·cm).

After replacing the motor, carry out the procedure in reverse order.

The motor rotor rotates. Clamp the cable so that the cable does not contact the rotor.

Use caution not to forget to tighten bolts and screws and to connect the cable.

Turn On the safety switch and confirm if the equipment operates properly.

The above steps complete the motor replacement procedure.

15.5.3.7 Motor replacement procedure for NKE-2255-7/9/6HS

- 1 Turn Off the safety switch of the radar antenna.

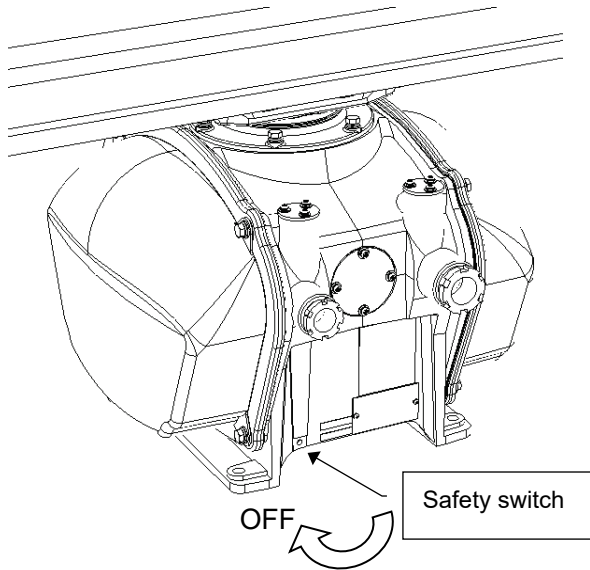

⚠ When replacing a motor, ensure that the safety switch of the radar antenna is turned Off prior to commencing the replacement work.

The safety switch is located on the rear bottom part of the radar antenna.
Turn Off the safety switch.

- 2 Remove the cover.

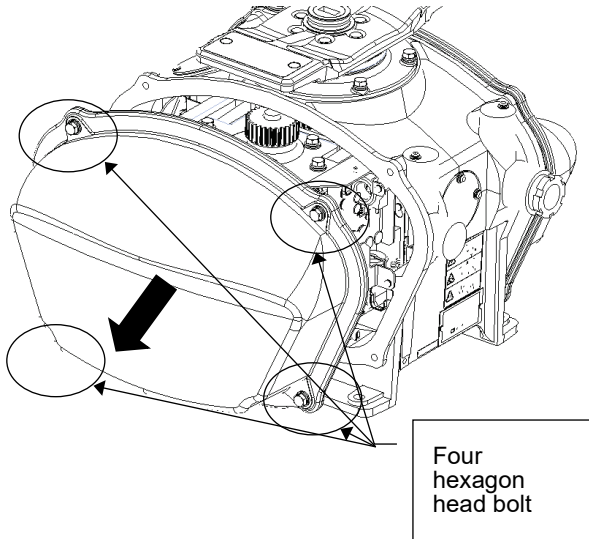

The motor is incorporated on the left side (port side) of the radar antenna. Remove the cover on the left side. The cover is secured in place with hexagon head bolts (M8, designed to be protected from falling out) at four positions.

After removing the cover, place it in a safe area.
Exercise care to avoid dust or other foreign matters adhering to the packing.

- 3 Remove the motor cable.

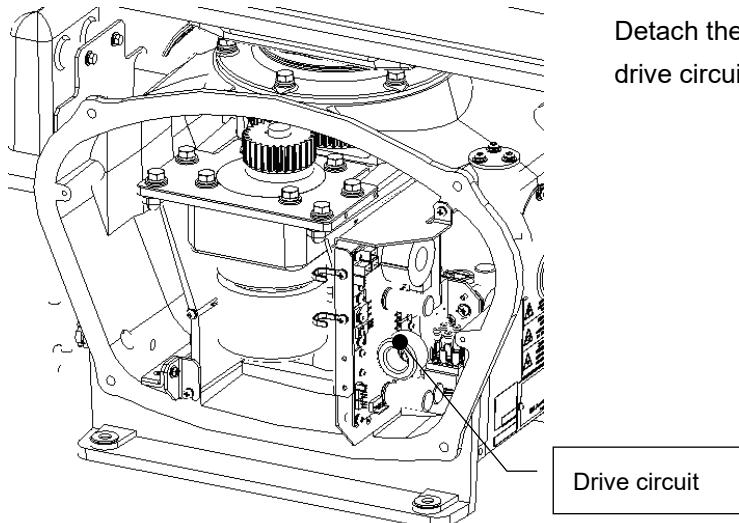

Detach the motor cable connected to the drive circuit.

4 Replace the motor.

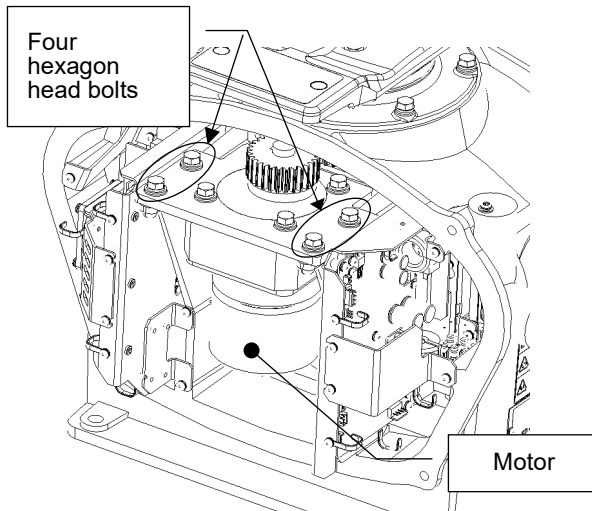

The motor is secured in place with hexagon head bolts (M8×20 SW W built-in type) at four positions.

Remove the four hexagon head bolts.

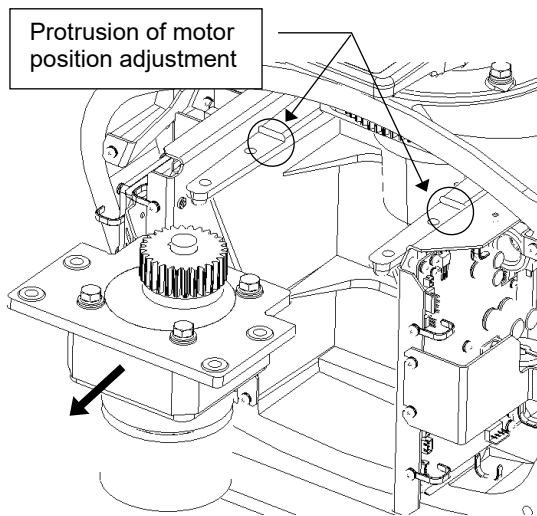

Remove the motor.

 The weight of the motor is about 6 kg. Use due caution when undertaking this procedure.

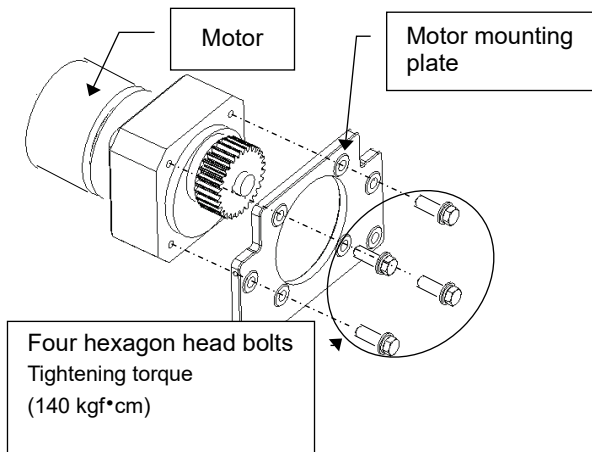

Mount the mounting plate on the motor to be replaced.

Remove the motor mounting plate from the removed motor. The mounting plate is secured in place with stainless hexagon head bolts (M8×30 SW W built-in type) at four positions.

Mount the removed parts on the motor to be replaced. Tighten the hexagon head bolts at a proper torque (140 kgf·cm) to ensure that there are no tightening omission and looseness.

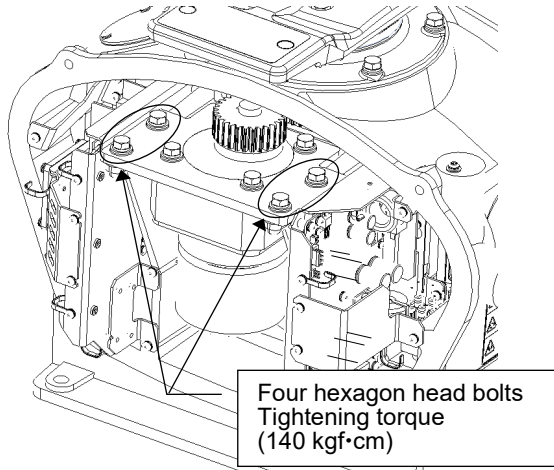

Incorporate the motor on the radar antenna.

Press the motor against the butting part of the mounting arm from the cabinet, make adjustment so that the backlash becomes minimum, and secure the motor.

Tighten the hexagon head bolts at a proper torque (140 kgf·cm) to ensure that there are no tightening omission and looseness.

After incorporating the motor, apply grease to the gears.

5 Connect the motor cables.

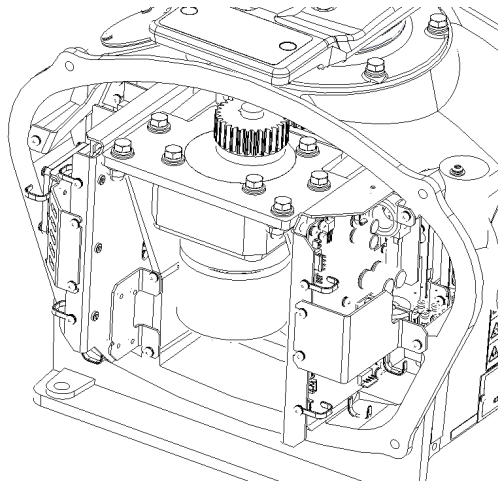

Connect cables to the drive circuit in the original state.

6 Install the cover.

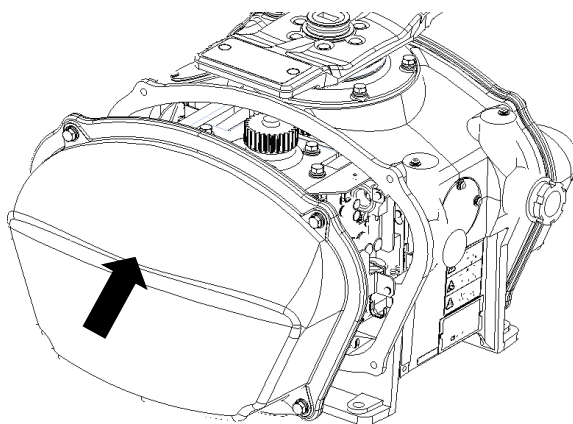

Before mounting the cover on the radar antenna, confirm that there are no abnormalities such as deformation and crack on the cover packing.

Remove any foreign matters, dust or other contaminants if found.

The cover is secured with four hexagon head bolts (M8).

Tightening omission and looseness of the hexagon head bolts adversely affect waterproof performance. Tighten the bolts at a proper torque so that there are no tightening omission and looseness.

After the motor replacement is complete, turn on the safety switch of the radar antenna.

The above steps complete the motor replacement procedure.

15.6 Software Update

This section describes software update of this equipment.

Memo

When software update starts, the currently active mode is terminated automatically. Complete the necessary operations such as the saving of settings prior to the start of update.

[Operation procedure]

Open the Software Update screen by performing the following menu operations.

[Menu] button → Maintenance → Software Update

- 1 **Set the USB memory device containing the update data.**
- 2 **Click on the [Software Update] button.**
A file selection dialogue appears.
- 3 **From the [Drive] combo box, select the drive where the updating data is stored.**
- 4 **Select MR_xx.xx.xxx.exe from the file list.**
MR_xx.xx.xxx.exe is displayed in [File Name].
- 5 **Click on the [OK] button.**
The update content confirmation dialogue appears.
- 6 **Confirm the contents and click on [OK].**
Installation starts and a screen is displayed indicating that installation is being performed.
Wait for some time until the installation is completed.

Memo

This equipment may restart during installation.

At completion of installation, an installation completion screen is displayed.

- 7 **Switch OFF the power supply of this equipment.**
- 8 **Restart this equipment.**
- 9 **Check that the software version number has been updated on the [Software] tab that is displayed by selecting menus, [Maintenance] – [System Information].**

15.7 Updating Help Data

This section describes updating of help data of this product.

Memo

When Help is updated, the currently active mode is terminated automatically. Complete the necessary operations such as the saving of settings prior to the start of update.

[Operation procedure]

Open the Software Update screen by performing the following menu operations.

[Menu] button → Maintenance → Software Update

- 1 **Set the USB memory device containing update data.**
- 2 **Click on the [Help Install] button.**
A file selection dialogue is displayed.
- 3 **Select the drive containing update data from the [Drive] combo box.**
- 4 **Select the folder containing update data from the folder tree and check the help file to be updated from the file list.**
- 5 **Click on the [Install] button.**
Installation starts and a screen is displayed indicating that installation is being performed.
Wait until installation is completed.
At completion of installation, an installation completion screen is displayed.
- 6 **Click on the [OK] button.**

Memo

- When the [Cancel] button is clicked on during installation, installation of subsequent files is cancelled after the installation of the file that is currently being installed is completed.
- When the selected update file already exists, a screen is displayed indicating that the file has been installed. End the operation by clicking on the [Cancel] button.

15.8 Data Backup/Restore

WARNING



Do not turn off the power supply during backup/restore.
Otherwise, a function fault occurs, leading to the possibility of an accident.

15.8.1 Backing up data

To maintain customer data, back up the data regularly by using the following procedure.
Connect an external medium such as a USB memory device for backup.

- 1 **Press the Power supply button of the operation unit.**
The power supply button is lit. Then, the Mode Selection screen is displayed.
- 2 **Click on the [Data Backup/Restore] button on the Mode Selection screen.**
The [Backup/Restore] dialogue is displayed.
- 3 **Click on the [Data Backup] tab.**
- 4 **Select a drive of the data backup destination from the drive selection combo box.**
- 5 **Click on the [Start] button.**
A confirmation dialogue is displayed.
- 6 **Click on the [OK] button.**
Copying of data to the backup destination that is selected in the drive selection combo box starts.

Memo

Do not perform any other operations until backup is completed. Otherwise, backup may fail.

15.8.2 Restoring backed up data

Use the following procedure to restore backed up data into this equipment.

Connect the external medium (USB memory device, etc.) in which backup data has been saved.

1 **Press the power supply button of the operation unit.**

The power supply button is lit. A short time later, the Mode Selection screen is displayed.

2 **Click on the [Data Backup/Restore] button on the Mode Selection screen.**

The [Backup/Restore] dialogue is displayed.

3 **Click on the [Data Restore] tab.**

4 **Select the drive in which backup data has been saved from the drive selection combo box.**

5 **Click on the [Start] button.**

A confirmation dialogue is displayed.

6 **Click on the [OK] button.**

Restoration of data from the drive that was selected from the drive selection combo box to the hard disc of this equipment starts.

If data already exists in the hard disc, an overwriting confirmation dialogue is displayed.

To start restoration, click on the [OK] button.

Memo

- Do not perform any other operations until restoration is completed. Otherwise, restoration may fail.
- If backup is executed while enough free space is not available in the USB memory device, the "Error" message is displayed. Secure free space before executing backup. For the size of the data to be backed up, check the [Usage] column in the "File Information" list in "14.4.1 Managing storage".
- If the data to be restored is incompatible with this equipment, the data is not restored.



Section 16 Failures and After-Sale Services

16.1 Failure Detection

Semiconductor circuits can be considered to be almost free from defective semiconductors and/or performance deterioration except when there are design and inspection errors, or external and human induced causes. Generally, the causes of comparably frequent failures include line disconnection due to humidity of the high resistor, failure of the variable resistor as well as contact failures of switches and relays.

In addition to faulty parts, faulty adjustments (especially faulty tuning) or faulty maintenance (especially faulty cable contact) occasionally make up causes of failures; thus, it is effective to reinspect or readjust these items.

16.1.1 About alerts

Failures can be detected from alerts.

For details on alerts, please refer to "Appendix B, Alert List."

16.1.2 Alert description

For a description of alerts to be displayed, please refer to "Appendix B, Alert List."

16.1.3 Fuse inspection

Because there is a specific cause for any fuse meltdown, it is necessary to check the related circuits even if there is no abnormality after changing a fuse. However, please give consideration that the fuse meltdown characteristics vary significantly. The following table shows a list of the fuses used in this unit.

List of Fuses Used

| Placement Location | Part No. | Rated current | Protection circuit | Model name |
|--|----------|---------------|--|-------------|
| Radar processing unit (JMR-5404-X, JMR-5406-X) | F2 | 3.15A | I/F circuit | ST4-3.15AN1 |
| Radar processing unit (JMR-5406-X) | F3 | 5A | I/F circuit | ST4-5AN1 |
| Radar processing unit (JMR-5410-4X/4XH/ 6X/6XH) | F2 | 5A | Input/output circuit (CMH-2452) PC4401 | ST4-5AN1 |
| | F3 | 10A | | ST6-10AN1 |
| Radar processing unit (JMR-5425-7X/9X/6XH, JMR-5430-S, JMR-5472-S, JMR-5482-S/SH) | F2 | 10A | Input/output circuit (CMH-2452) PC4401 | ST6-10AN1 |
| | F3 | 10A | | ST6-10AN1 |

16.2 Countermeasures for Failures

Because radar equipment is composed of complex circuits, please ask a qualified technician for repair or instructions regarding countermeasures in case of failure.

Note that failures may be caused by the following causes, so check them during inspection or repair of failure.

- Contact failure in terminal blocks of cables between equipment
 - a) Contact failure in terminal blocks
 - b) Cable terminal treatment failure - In contact with other grounded terminal
 - c) Cable disconnection
- Contact failure of connectors inside equipment

Table 16-1 lists the standard spare parts that this radar equipment is provided with.

Table 16-1 Spare parts (7ZPRD0012: JMR-5404-X,

7ZPRD0013: JMR-5406-X,

7ZXRD0026: JMR-5410-4X/4XH/6X/6XH,

7ZXRD0015: JMR-5425-7X/9X/6XH, JMR-5430-S, JMR-5472-S, JMR-5482-S/SH)

7ZXRD0012

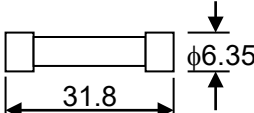
| Item Name | Model Name/ Code | Shape (Unit: mm) | In use | Spare | Part No. | Location of Use |
|-----------|-----------------------------|---|--------|-------|----------|---------------------------|
| Fuse | ST4-3.15AN1 (5ZFCA00047) |  | 1 | 3 | F2 | Inside of processing unit |

7ZXRD0013

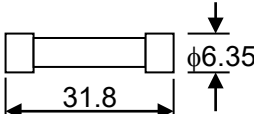
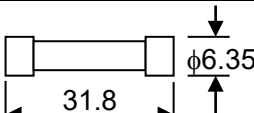
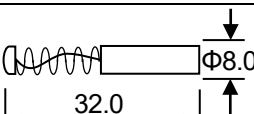
| Item Name | Model Name/ Code | Shape (Unit: mm) | In use | Spare | Part No. | Location of Use |
|--------------|-----------------------------|---|--------|-------|----------|---------------------------|
| Fuse | ST4-3.15AN1 (5ZFCA00047) |  | 1 | 3 | F2 | Inside of processing unit |
| Fuse | ST4-5AN1 (5ZFCA00050) |  | 1 | 3 | F3 | Inside of processing unit |
| Carbon Brush | 54531-01 (BRXP05247) |  | 1 | 3 | — | Inside of radar antenna |

7ZXRD0026

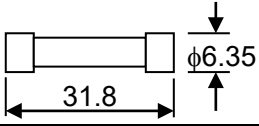
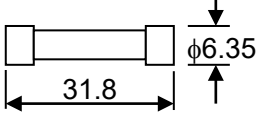
| Item Name | Model Name/ Code | Shape (Unit: mm) | In use | Spare | Part No. | Location of Use |
|-----------|---------------------------|---|--------|-------|----------|---------------------------|
| Fuse | ST4-5AN1 (5ZFCA00050) |  | 1 | 3 | F2 | Inside of processing unit |
| Fuse | ST6-10AN1 (5ZFCA00053) |  | 1 | 3 | F3 | Inside of processing unit |

7ZXRD0015

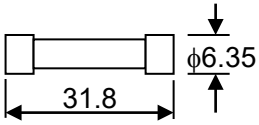
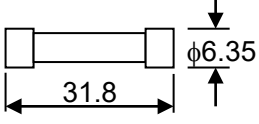
| Item Name | Model Name/ Code | Shape (Unit: mm) | In use | Spare | Part No. | Location of Use |
|-----------|---------------------------|--|--------|-------|----------|---------------------------|
| Fuse | ST6-10AN1 (5ZFCA00053) |  | 1 | 3 | F2 | Inside of processing unit |
| Fuse | ST6-10AN1 (5ZFCA00053) |  | 1 | 3 | F3 | Inside of processing unit |

16.2.1 Special parts

Memo Only the magnetrons specified in the following table can be used.

[I] JMR-5404-X (NKE-2043)

| Part No. | Item Name | Model Name | Manufacturer | Location of Use | Code |
|----------|---------------|------------|-----------------|-----------------|------------|
| V101 | Magnetron | MSF1421B | New Japan Radio | Radar antenna | 5VMAA00092 |
| A101 | Circulator | FCX68 | OrientMicrowave | Radar antenna | 5AJIX00027 |
| A102 | Diode limiter | NJS6930 | New Japan Radio | Radar antenna | 5ATBT00006 |

[II] JMR-5406-X (NKE-2063A)

| Part No. | Item Name | Model Name | Manufacturer | Location of Use | Code |
|----------|---------------|------------|-----------------|-----------------|------------|
| V101 | Magnetron | MSF1422B | New Japan Radio | Radar antenna | 5VMAA00090 |
| A101 | Circulator | FCX68R | OrientMicrowave | Radar antenna | 5AJIX00027 |
| A102 | Diode limiter | NJS6930 | New Japan Radio | Radar antenna | 5ATBT00006 |

[III] JMR-5410-4X/4XH/6X/6XH (NKE-2103)

| Part No. | Item Name | Model Name | Manufacturer | Location of Use | Code |
|-----------|---------------|------------|------------------|-----------------|------------|
| V101 | Magnetron | MAF1565N | New Japan Radio | Radar antenna | 5VMAA00102 |
| A101/A102 | Circulator | FCX68R | Orient Microwave | Radar antenna | 5AJIX00027 |
| A103 | Dummy | NJC4002 | New Japan Radio | Radar antenna | 5ANDF00001 |
| A104 | Filter | NJC9952 | New Japan Radio | Radar antenna | 5AWAX00002 |
| A301 | Diode limiter | NJS6930 | New Japan Radio | Radar antenna | 5ATBT00006 |

[IV] JMR-5425-7X/9X/6XH (NKE-2255)

| Part No. | Item Name | Model Name | Manufacturer | Location of Use | Code |
|-----------|---------------|------------|-----------------|-----------------|------------|
| V101 | Magnetron | CMG-347 | Japan Radio | Radar antenna | CMG347 |
| A101/A102 | Circulator | NJC3901M | New Japan Radio | Radar antenna | 5AJBV00007 |
| A105 | Dummy | NJC4002 | New Japan Radio | Radar antenna | 5ANDF00001 |
| A103 | Filter | NJC9952 | New Japan Radio | Radar antenna | 5AWAX00002 |
| A104 | Diode limiter | NJS6930 | New Japan Radio | Radar antenna | 5ATBT00006 |

[V] JMR-5430-S (NKE-1130/A)

| Part No. | Item Name | Model Name | Manufacturer | Location of Use | Code |
|----------|---------------|------------|-----------------|-----------------|------------|
| V101 | Magnetron | CMG-348 | Japan Radio | Radar antenna | CMG348 |
| A101 | Circulator | NJC3316 | New Japan Radio | Radar antenna | 5AJBV00008 |
| A301 | Diode limiter | NJS6318 | New Japan Radio | Radar antenna | 5ATBT00005 |

16.2.2 Repair circuit block

Memo The asterisk (*) at the end of a model name in the following table indicates the revision such as A or B.

Repair Circuit Block (JMR-5404-X)

| Location | Circuit Block Name | Model Name | Remarks |
|-----------------|---|-------------|--|
| Radar antenna | NKE-2043 | | |
| | Motor | 7BDRD0052* | |
| | Compound Modulator Circuit | CME-385 | |
| | Receiver | NRG-239 | Including CAE-548 |
| Display unit | | | |
| Display | NWZ-214 | | 19-inch, supports DC |
| | NWZ-214-AC | | 19-inch, supports AC |
| | NWZ-208 | | 26-inch, supports both AC and DC |
| | 19-inch MNU replacement FAN kit | H-7BFRD0008 | Incorporated into NWZ-214/-AC |
| | 26-inch MNU replacement FAN kit | H-7ZYNA4005 | Incorporated into NWZ-208 |
| Processing unit | | | |
| Processing unit | NDC-1678/A | | |
| | Processing circuit for repair | NZC-1678A | Including CMC-1430A, CDC-1476A, CDD-760, CYC-847, upper base and FAN |
| | FAN kit for processing unit replacement | 7BFRD0012 | |
| | Interface unit | NQA-2587 | |
| | Power supply unit | NBD-945 | |
| Operation unit | | | |
| Operation unit | NCE-5794 | | Standard operation unit |
| | Operation circuit A | CCK-1096 | MPU circuit |
| | Operation circuit B | CCK-1097 | USB/SDHC connector circuit |
| | Operation circuit C | CCK-1098 | Key encoder circuit |
| | Trackball | CCK-1101 | |
| | φ38 button | MPHD30460 | |
| | φ22 button | MPHD30459 | |
| | Screw cover | MTV305169 | |

Repair Circuit Block (JMR-5406-X)

| Location | Circuit Block Name | Model Name | Remarks |
|---------------------------------|---|---------------------------|--|
| Radar antenna | NKE-2063A | | |
| | Motor | CBP-218 | DC brushless motor |
| | Compound Modulator Circuit | CME-386 | Excluding Magnetron |
| | Receiver | NRG-239 | Including CAE-548 |
| Display unit | | | |
| Display | NWZ-214 | | 19-inch, supports DC |
| | NWZ-214-AC | | 19-inch, supports AC |
| | NWZ-208 | | 26-inch, supports both AC and DC |
| | 19-inch MNU replacement FAN kit | H-7BFRD0008 | Incorporated into NWZ-214/-AC |
| 26-inch MNU replacement FAN kit | H-7ZYNA4005 | Incorporated into NWZ-208 | |
| Processing unit | NDC-1678/A | | |
| | Processing circuit for repair | NZC-1678A | Including CMC-1430A, CDC-1476A, CDD-760, CYC-847, upper base and FAN |
| | FAN kit for processing unit replacement | 7BFRD0012 | |
| | Interface unit | NQA-2587 | |
| | Power supply unit | NBD-945 | |
| Operation unit | NCE-5794 | | Standard operation unit |
| | Operation circuit A | CCK-1096 | MPU circuit |
| | Operation circuit B | CCK-1097 | USB/SDHC connector circuit |
| | Operation circuit C | CCK-1098 | Key encoder circuit |
| | Trackball | CCK-1101 | |
| | φ38 button | MPHD30460 | |
| | φ22 button | MPHD30459 | |
| | Screw cover | MTV305169 | |

Repair Circuit Block (JMR-5410-4X/4XH/6X/6XH)

| Location | Circuit Block Name | Model Name | Remarks |
|-----------------|---|-------------|--|
| Radar antenna | | NKE-2103 | |
| | DC brushless motor | 7BDRD0048* | |
| | Motor control power supply circuit | CBD-1779 | |
| | Encoder unit | CHT-71A | |
| | Brake circuit | CFA-252 | |
| | Performance monitor | NJU-85 | |
| | Modulation circuit | CME-363 | Not including the magnetron |
| | Receiver | NRG-610 | Including the CAE-529-1 |
| | Power supply circuit | CBD-1783 | |
| Display unit | | | |
| Display | | NWZ-214 | 19-inch, supports DC |
| | | NWZ-214-AC | 19-inch, supports AC |
| | | NWZ-208 | 26-inch, supports both AC and DC |
| | 19-inch MNU replacement FAN kit | H-7BFRD0008 | Incorporated into NWZ-214/-AC |
| | 26-inch MNU replacement FAN kit | H-7ZYNA4005 | Incorporated into NWZ-208 |
| Processing unit | | NDC-1678/A | |
| | Processing circuit for repair | NZC-1678A | Including CMC-1430A, CDC-1476A, CDD-760, CYC-847, upper base and FAN |
| | FAN kit for processing unit replacement | 7BFRD0012 | |
| | Interface unit | NQA-2587 | |
| | Power supply unit | NBD-945 | |
| Operation unit | | NCE-5794 | Standard operation unit |
| | Operation circuit A | CCK-1096 | MPU circuit |
| | Operation circuit B | CCK-1097 | USB/SDHC connector circuit |
| | Operation circuit C | CCK-1098 | Key encoder circuit |
| | Trackball | CCK-1101 | |
| | φ38 button | MPHD30460 | |
| | φ22 button | MPHD30459 | |
| | Screw cover | MTV305169 | |

Repair Circuit Block (JMR-5425-7X/9X/6XH)

| Location | Circuit Block Name | Model Name | Remarks |
|--------------------------|---|-------------|--|
| Radar antenna | NKE-2255 | | |
| | DC brushless motor | 7BDRD0044A* | Normal rotation |
| | DC brushless motor | 7BDRD0045A* | High-speed rotation |
| | Transmitter-receiver unit | NZT-17 | Including the NWA-574, NRG-246, CMC-1429, CMK-639, magnetron. |
| | Transmitter circuit | CME-406 | |
| | MAG filter circuit | CFR-259 | |
| | Reception unit | NRG-246 | |
| | Control circuit | CMC-1429 | |
| | Power supply circuit | CBD-2682 | |
| | Drive circuit | CCB-690 | |
| | Inside of drive unit | CFA-299 | |
| | Encoder unit | CHT-85A* | |
| | Power supply fan | H-7BFRD0010 | |
| | Transmitter circuit fan | H-7BFRD0011 | |
| Performance monitor unit | NJU-97 | | |
| Display unit | | | |
| Display | NWZ-214 | | 19-inch, supports DC |
| | NWZ-214-AC | | 19-inch, supports AC |
| | NWZ-208 | | 26-inch, supports both AC and DC |
| | 19-inch MNU replacement FAN kit | H-7BFRD0008 | Incorporated into NWZ-214/-AC |
| | 26-inch MNU replacement FAN kit | H-7ZYNA4005 | Incorporated into NWZ-208 |
| Processing unit | | | |
| Processing unit | NDC-1678/A | | |
| | Processing circuit for repair | NZC-1678A | Including CMC-1430A, CDC-1476A, CDD-760, CYC-847, upper base and FAN |
| | FAN kit for processing unit replacement | 7BFRD0012 | |
| | Interface unit | NQA-2587 | |
| | Power supply unit | NBD-945 | |
| Operation unit | | | |
| Operation unit | NCE-5794 | | Standard operation unit |
| | Operation circuit A | CCK-1096 | MPU circuit |
| | Operation circuit B | CCK-1097 | USB/SDHC connector circuit |
| | Operation circuit C | CCK-1098 | Key encoder circuit |
| | Trackball | CCK-1101 | |
| | φ38 button | MPHD30460 | |
| | φ22 button | MPHD30459 | |
| | Screw cover | MTV305169 | |

Repair Circuit Block (JMR-5430-S)

| Location | Circuit Block Name | Model Name | Remarks |
|---------------------------------|---|---------------------------|--|
| Radar antenna | NKE-1130/A | | |
| | Geared Motor | MDBW10823* | |
| | 220VAC motor driver | 7EPRD0034* | NKE-1130, For 220-240VAC, 50/60 Hz, 1 ϕ |
| | 100VAC motor driver | 7EPRD0035* | NKE-1130, For 100-115VAC, 50/60 Hz, 1 ϕ |
| | 100/220VAC motor driver | CBD-2400 | NKE-1130A, For 100/220VAC, 50/60 Hz, 1 ϕ |
| | Encoder unit | CHT-71A | |
| | Brake circuit | CFA-255 | |
| | Brake control circuit | CCB-655 | For NKE-1130 |
| | Brake circuit unit | NZR-17 | For NKE-1130 Including the CFA-261, CFA-262 |
| | Fan (B103/B104) | 7BFRD0002* | |
| | Performance monitor | NJU-84 | |
| | Modulation unit | NMA-551-1 | Including the CPA-264, CMB-406, CFR-229 Not including the magnetron |
| | Modulation circuit | CPA-264 | |
| | Receiver | NRG-229 | Including the CAE-499, CAF-595 |
| | T/R control circuit | CMC-1205R | |
| Power supply circuit | CBD-1682A | | |
| Relay filter circuit | CSC-656 | For NKE-1130 | |
| Display unit | | | |
| Display | NWZ-214 | | 19-inch, supports DC |
| | NWZ-214-AC | | 19-inch, supports AC |
| | NWZ-208 | | 26-inch, supports both AC and DC |
| | 19-inch MNU replacement FAN kit | H-7BFRD0008 | Incorporated into NWZ-214/-AC |
| 26-inch MNU replacement FAN kit | H-7ZYNA4005 | Incorporated into NWZ-208 | |
| Processing unit | NDC-1678/A | | |
| | Processing circuit for repair | NZC-1678A | Including CMC-1430A, CDC-1476A, CDD-760, CYC-847, upper base and FAN |
| | FAN kit for processing unit replacement | 7BFRD0012 | |
| | Interface unit | NQA-2587 | |
| | Power supply unit | NBD-945 | |
| Operation unit | NCE-5794 | | Standard operation unit |
| | Operation circuit A | CCK-1096 | MPU circuit |
| | Operation circuit B | CCK-1097 | USB/SDHC connector circuit |
| | Operation circuit C | CCK-1098 | Key encoder circuit |
| | Trackball | CCK-1101 | |
| | ϕ 38 button | MPHD30460 | |
| | ϕ 22 button | MPHD30459 | |
| | Screw cover | MTV305169 | |

Repair Circuit Block (JMR-5472-S)

| Location | Circuit Block Name | Model Name | Remarks |
|---------------------|---|--------------|--|
| Radar antenna | NKE-1632/A | | |
| | TRX module | CMN-797 | |
| | Signal processing unit | NDC-4920 | |
| | Power supply/interface circuit | CMP-493 | |
| | Encoder | CHT-85 | |
| | Fan | 109L0912S410 | |
| | Motor driver circuit | CBD-1949 | NKE-1632, Shared by 100/220VAC |
| | Motor driver circuit | CBD-2400 | NKE-1632A, Shared by 100/220VAC |
| | Geared motor | MDBW10823* | Shared by 100/220VAC |
| | Brake circuit | CFA-295 | |
| Performance antenna | CAY-77 | | |
| Display unit | | | |
| Display | NWZ-214 | | 19-inch, supports DC |
| | NWZ-214-AC | | 19-inch, supports AC |
| | NWZ-208 | | 26-inch, supports both AC and DC |
| | 19-inch MNU replacement FAN kit | H-7BFRD0008 | Incorporated into NWZ-214/-AC |
| | 26-inch MNU replacement FAN kit | H-7ZYNA4005 | Incorporated into NWZ-208 |
| Processing unit | | | |
| Processing unit | NDC-1678/A | | |
| | Processing circuit for repair | NZC-1678A | Including CMC-1430A, CDC-1476A, CDD-760, CYC-847, upper base and FAN |
| | FAN kit for processing unit replacement | 7BFRD0012 | |
| | Interface unit | NQA-2587 | |
| | Power supply unit | NBD-945 | |
| Operation unit | | | |
| Operation unit | NCE-5794 | | Standard operation unit |
| | Operation circuit A | CCK-1096 | MPU circuit |
| | Operation circuit B | CCK-1097 | USB/SDHC connector circuit |
| | Operation circuit C | CCK-1098 | Key encoder circuit |
| | Trackball | CCK-1101 | |
| | φ38 button | MPHD30460 | |
| | φ22 button | MPHD30459 | |
| | Screw cover | MTV305169 | |

Repair Circuit Block (JMR-5482-S)

| Location | Circuit Block Name | Model Name | Remarks |
|---------------------------------|---|---------------------------|--|
| Radar antenna | NKE-2632/A | | |
| | TRX module | CMN-797 | |
| | Signal processing unit | NDC-4920 | |
| | Power supply/interface circuit | CMP-493 | |
| | Encoder | CHT-85 | |
| | Fan | 109L0912S410 | |
| | Motor driver circuit | CBD-1949 | NKE-2632, Shared by 100/220VAC |
| | Motor driver circuit | CBD-2400 | NKE-2632A, Shared by 100/220VAC |
| | Geared motor | MDBW10823* | Shared by 100/220VAC |
| | Brake circuit | CFA-295 | |
| Performance antenna | CAY-77 | | |
| Display unit | | | |
| Display | NWZ-214 | | 19-inch, supports DC |
| | NWZ-214-AC | | 19-inch, supports AC |
| | NWZ-208 | | 26-inch, supports both AC and DC |
| | 19-inch MNU replacement FAN kit | H-7BFRD0008 | Incorporated into NWZ-214/-AC |
| 26-inch MNU replacement FAN kit | H-7ZYNA4005 | Incorporated into NWZ-208 | |
| Processing unit | | | |
| Processing unit | NDC-1678/A | | |
| | Processing circuit for repair | NZC-1678A | Including CMC-1430A, CDC-1476A, CDD-760, CYC-847, upper base and FAN |
| | FAN kit for processing unit replacement | 7BFRD0012 | |
| | Interface unit | NQA-2587 | |
| Power supply unit | NBD-945 | | |
| Operation unit | | | |
| Operation unit | NCE-5794 | | Standard operation unit |
| | Operation circuit A | CCK-1096 | MPU circuit |
| | Operation circuit B | CCK-1097 | USB/SDHC connector circuit |
| | Operation circuit C | CCK-1098 | Key encoder circuit |
| | Trackball | CCK-1101 | |
| | φ38 button | MPHD30460 | |
| | φ22 button | MPHD30459 | |
| Screw cover | MTV305169 | | |

Repair Circuit Block (JMR-5482-SH)

| Location | Circuit Block Name | Model Name | Remarks |
|---------------------------------|---|---------------------------|--|
| Radar antenna | NKE-2632-H | | |
| | TRX module | CMN-797 | |
| | Signal processing unit | NDC-4920 | |
| | Power supply/interface circuit | CMP-493 | |
| | Encoder | CHT-85 | |
| | Fan | 109L0912S410 | |
| | Motor driver circuit | CBD-1950 | Shared by 100/220VAC |
| | Geared motor | MDBW10967* | Shared by 100/220VAC |
| | Brake circuit | CFA-297 | |
| Performance antenna | CAY-77 | | |
| Display unit | | | |
| Display | NWZ-214 | | 19-inch, supports DC |
| | NWZ-214-AC | | 19-inch, supports AC |
| | NWZ-208 | | 26-inch, supports both AC and DC |
| | 19-inch MNU replacement FAN kit | H-7BFRD0008 | Incorporated into NWZ-214/-AC |
| 26-inch MNU replacement FAN kit | H-7ZYNA4005 | Incorporated into NWZ-208 | |
| Processing unit | | | |
| Processing unit | NDC-1678/A | | |
| | Processing circuit for repair | NZC-1678A | Including CMC-1430A, CDC-1476A, CDD-760, CYC-847, upper base and FAN |
| | FAN kit for processing unit replacement | 7BFRD0012 | |
| | Interface unit | NQA-2587 | |
| | Power supply unit | NBD-945 | |
| Operation unit | | | |
| Operation unit | NCE-5794 | | Standard operation unit |
| | Operation circuit A | CCK-1096 | MPU circuit |
| | Operation circuit B | CCK-1097 | USB/SDHC connector circuit |
| | Operation circuit C | CCK-1098 | Key encoder circuit |
| | Trackball | CCK-1101 | |
| | φ38 button | MPHD30460 | |
| | φ22 button | MPHD30459 | |
| Screw cover | MTV305169 | | |

16.3 Troubleshooting

When this equipment does not operate correctly, check the following points before asking for repairs. Consult with your nearest subsidiary company, branch office, or sales office if the problem does not get solved even after checking and correcting these points, or if there are any abnormally locations other than the following items.

| Symptom | Cause | Action |
|--|--|--|
| The power is not supplied. Alternatively, the equipment does not start even if the Power button of the operation unit is pressed. | The DC power supply is not connected. | Connect the DC power supply. |
| | The AC power supply is not connected to the rectifier when rectifier NBA-5111 is used. | Connect the AC power supply. |
| | The main power supply at the front of the processing unit (NDC-1678/A) is not set to ON. | Set the main power supply to ON by lifting the lever of the breaker. |
| | The DC power supply is not within the specified voltage range. | Connect the DC power supply within the specified voltage range. |
| | The internal wiring is faulty. | Make a request to the distributor for repair. |
| | The power supply circuit of the processing unit (NDC-1678/A) is faulty. | Make a request to the distributor for repair. |
| | The operation unit (NCE-5794)/optional operation unit (NCE-5605) is faulty. | Make a request to the distributor for repair. |
| The power is not supplied to the monitor. | The display unit is not activated. | Activate the display unit. |
| | The internal wiring is faulty. | Make a request to the distributor for repair. |
| | The display (NWZ-208/NWZ-214) is faulty. | Make a request to the distributor for repair. |
| Although the power is supplied to the monitor, the screen is not displayed. | The brightness of the monitor is set to the minimum level. | Adjust the brightness of the monitor to the appropriate level. |
| | The internal wiring is faulty. | Make a request to the distributor for repair. |
| | The display (NWZ-208/NWZ-214) is faulty. | Make a request to the distributor for repair. |
| The brightness of the monitor cannot be adjusted. | The display (NWZ-208/NWZ-214) is faulty. | Make a request to the distributor for repair. |
| The trackball or the option keyboard cannot be operated. | The internal wiring is faulty. | Make a request to the distributor for repair. |
| | The operation unit (NCE-5794)/optional operation unit (NCE-5605/NCE-5625) is faulty. | Make a request to the distributor for repair. |

| Symptom | Cause | Action |
|--|---|---|
| The trackball does not move smoothly. | The trackball is dirty. | Clean the trackball. |
| Although the power is supplied and the screen is displayed, the display is frozen, disabling display of the mode selection screen. | The processing unit (NDC-1678/A) is abnormal. | Make a request to the distributor for repair. |
| Some menus cannot be selected on the mode selection screen. | The device licence has not been installed. | Request repair or additional arrangement to the supplier and install the licence. |
| The cursor is not displayed correctly. | The processing unit (NDC-1678/A) is faulty. | Make a request to the distributor for repair. |
| Characters/symbols are not displayed correctly. | The processing unit (NDC-1678/A) is faulty. | Make a request to the distributor for repair. |
| Position information (GPS) is not displayed. | The communication is not set correctly. | Set the communication correctly. |
| | The power supply for the GPS equipment is not turned on. | Turn on the power supply for the GPS equipment. |
| | The GPS equipment does not perform positioning. | Check the state of the GPS equipment. |
| | The connection with the GPS equipment is abnormal. | Check the connection with the GPS equipment. When GPS equipment is connected to the serial LAN interface circuit, check if the LED of the corresponding port is lit at data reception. |
| | The internal wiring is faulty. | Make a request to the distributor for repair. |
| | The processing unit (NDC-1678/A) is faulty. | Make a request to the distributor for repair. |
| | The power is not supplied to the serial LAN interface circuit (CMH-2370) inside of junction box NQE-1143. (Case where the GPS equipment is connected to junction box NQE-1143) | Turn on the power supply for the serial-LAN interface circuit. |
| | The serial LAN interface circuit (CMH-2370) inside of junction box NQE-1143 is faulty. (Case where the GPS equipment is connected to the serial LAN interface circuit) | Make a request to the distributor for repair. |

| Symptom | Cause | Action |
|--|--|--|
| AIS information is not displayed. | The communication is not set correctly. | Set the communication correctly. |
| | The power supply for the AIS equipment is not turned on. | Turn on the power supply for the AIS equipment. |
| | The AIS equipment does not perform positioning. | Check the state of the AIS equipment. |
| | The connection with the AIS equipment is abnormal. | Check the connection with the AIS equipment. When AIS equipment is connected to the terminal board circuit (CQD-2322), check if the LED of the corresponding port is lit at data reception. |
| | The internal wiring is faulty. | Make a request to the distributor for repair. |
| | The processing unit (NDC-1678/A) is faulty. | Make a request to the distributor for repair. |
| | The power is not supplied to the serial LAN interface (CMH-2370) inside of junction box NQE-1143. (Case where the AIS equipment is connected to junction box NQE-1143) | Turn on the power supply for the serial-LAN interface circuit. |
| | The power is not supplied to the serial LAN interface (CMH-2370) inside of junction box NQE-1143. (Case where the AIS equipment is connected to junction box NQE-1143) | Make a request to the distributor for repair. |
| The azimuth of the Gyro compass is not displayed. Alternatively, the azimuth rotation direction is not displayed correctly. | The communication is not set correctly. | Set the communication correctly. |
| | The power supply for the Gyro compass equipment is not turned on. | Turn on the power supply for the Gyro compass equipment. |
| | The connection with the Gyro compass equipment is abnormal. | Check the connection with the Gyro compass equipment. When Gyro compass equipment is connected to the terminal board circuit (CQD-2322), check if the corresponding LED is lit at signal reception. |
| | The internal wiring is faulty. | Make a request to the distributor for repair. |
| | The processing unit (NDC-1678/A) is faulty. | Make a request to the distributor for repair. |

| Symptom | Cause | Action |
|--|---|--|
| Log is not displayed or the values are not displayed correctly. | The communication is not set correctly. | Set the communication correctly. |
| | The power supply for the log equipment is not turned on. | Turn on the power supply for the log equipment. |
| | The connection with the log equipment is abnormal. | Check the connection with the log equipment. When log equipment is connected to the terminal board circuit (CQD-2322), check if the corresponding LED blinks at signal reception. |
| | The internal wiring is faulty. | Make a request to the distributor for repair. |
| | The processing unit (NDC-1678/A) is faulty. | Make a request to the distributor for repair. |
| Rudder angles are not displayed. Alternatively, the values are not displayed correctly. | The communication is not set correctly. | Set the communication correctly. |
| | The power supply for the rudder angle indicator is not turned on. | Turn on the power supply for the rudder angle indicator. |
| | The connection with the rudder angle indicator is abnormal. | Check the connection with the rudder angle indicator. When a rudder angle indicator is connected to the terminal board circuit (CQD-2322), check if the LED of the corresponding port is lit at data reception. |
| | The internal wiring is faulty. | Make a request to the distributor for repair. |
| | The processing unit (NDC-1678/A) is faulty. | Make a request to the distributor for repair. |
| Wind direction/wind speed (anemoscope/anemometer) data is not displayed | The communication is not set correctly. | Set the communication correctly. |
| | The power supply for the anemoscope/anemometer is not turned on. | Turn on the power supply for the anemoscope/anemometer. |
| | The connection with the anemoscope/anemometer is abnormal. | Check the connection with the anemoscope/anemometer. When an anemoscope/anemometer is connected to the terminal board circuit (CQD-2322), check if the LED of the corresponding port is lit at data reception. |
| | The internal wiring is faulty. | Make a request to the distributor for repair. |
| | The processing unit (NDC-1678/A) is faulty. | Make a request to the distributor for repair. |

| Symptom | Cause | Action |
|---------------------------------------|--|---|
| Water depth values are not displayed. | The communication is not set correctly. | Set the communication correctly. |
| | The power supply for the echo sounder is not turned on. | Turn on the power supply for the echo sounder. |
| | The connection with the echo sounder is abnormal. | Check the connection with the echo sounder. When an echo sounder is connected to the terminal board circuit (CQD-2322), check if the LED of the corresponding port is lit at data reception. |
| | The internal wiring is faulty. | Make a request to the distributor for repair. |
| | The processing unit (NDC-1678/A) is faulty. | Make a request to the distributor for repair. |
| Sensor signals are not displayed. | The communication is not set correctly. | Set the communication correctly. |
| | The power supply for the sensor equipment is not turned on. | Turn on the power supply for the sensor equipment. |
| | The connection with the sensor equipment is faulty. | Check the connection with the sensor equipment. Check if the LED of the corresponding port of the terminal board circuit (CQD-2322) is lit at data reception. |
| | When a sensor is connected to junction box NQE-1143, the power is not supplied to the serial LAN interface (CMH-2370) inside of junction box NQE-1143. | Turn on the power supply for the serial-LAN interface circuit. |
| | The internal wiring is faulty. | Make a request to the distributor for repair. |
| | The processing unit (NDC-1678/A) is faulty. | Make a request to the distributor for repair. |
| | The serial LAN interface circuit (CMH-2370) inside of junction box NQE-1143 is faulty. | Make a request to the distributor for repair. |

| Symptom | Cause | Action |
|---|--|---|
| Contact signals are not output. | The power supply for the serial-LAN interface circuit (CMH-2370) is not turned on. (Case where contact signal output is acquired from the serial-LAN interface circuit) | Turn on the power supply for the serial-LAN interface circuit. |
| | The internal wiring is faulty. | Make a request to the distributor for repair. |
| | The processing unit (NDC-1678/A) is faulty. | Make a request to the distributor for repair. |
| The radar antenna is not acknowledged. | The connection with the radar antenna is abnormal. | Check the connection with the radar antenna. |
| | Power is not supplied from the power supply unit to the radar antenna. | Check the power supply wiring of the interface circuit (CMH-2452) from the power supply unit. Check the power supply connection inside of the radar antenna. [Memo] For checking wiring inside of the radar antenna, always request the work to the specialized service person. Before starting the work, turn off the power supply of the display unit. Otherwise, an unexpected accident may occur. |
| | The radar antenna is faulty. | Make a request to the distributor for repair. |
| | The internal wiring is faulty. | Make a request to the distributor for repair. |
| | The processing unit (NDC-1678/A) is faulty. | Make a request to the distributor for repair. |
| The power is not supplied to the radar antenna. | The connection with the radar antenna is abnormal. | Check the connection with the radar antenna. |
| | The connection with the radar antenna is abnormal and overcurrent protection is functioning in the power supply unit. | Check the connection with the radar antenna and remove the cause of short-circuit. |
| | The 24V DC output fuse is blown out. | After removing the cause of the fuse blowout, replace the fuse. The fuse is F2. |
| | The internal wiring is faulty. | Make a request to the distributor for repair. |
| | The power supply (NDB-945) inside of the processing unit is faulty. | Make a request to the distributor for repair. |
| | The processing unit (NDC-1678/A) is faulty. | Make a request to the distributor for repair. |

| Symptom | Cause | Action |
|---|--|--|
| The preheat count down of the radar antenna is not displayed. | The connection with the radar antenna is abnormal. | Check the connection with the radar antenna. |
| | The safety switch of the radar antenna is set to OFF. | Set the safety switch of the radar antenna to ON. [Memo] For operating the safety switch of the radar antenna, always request the work to the specialized service person. Before starting the work, turn off the power supply of the display unit. Otherwise, an unexpected accident may occur. |
| | A solid-state radar antenna is connected. | Preheat count-down is not displayed for a solid-state radar antenna. |
| | The radar antenna is faulty. | Make a request to the distributor for repair. |
| | The internal wiring is faulty. | Make a request to the distributor for repair. |
| | The processing unit (NDC-1678/A) is faulty. | Make a request to the distributor for repair. |
| The radar antenna does not rotate even if the [TX/ST-BY] button is pressed. | The connection with the radar antenna is abnormal. | Check the connection with the radar antenna. |
| | The safety switch of the radar antenna is set to OFF. | Set the safety switch of the radar antenna to ON. [Memo] For operating the safety switch of the radar antenna, always request the work to the specialized service person. Before starting the work, turn off the power supply of the display unit. Otherwise, an unexpected accident may occur. |
| | Power is not supplied from the power supply unit to the radar antenna. | Check the power supply wiring from the power supply unit (NBD-945) inside the processing unit to the interface circuit (CMH-2452). Check the power supply connection inside of the radar antenna. [Memo] For checking the wiring inside of the radar antenna, always request the work to the specialized service person. Before starting the work, turn off the power supply of the display unit. Otherwise, an unexpected accident may occur. |

| Symptom | Cause | Action |
|---|--|--|
| The radar antenna does not rotate even if the [TX/ST-BY] button is pressed. | The 24VDC output fuse is blown out. | After removing the cause of the fuse blowout, replace the fuse. The fuse is F3. |
| | The motor driver circuit inside of the radar antenna is not set correctly. (When NKE-1130/A NKE-1632/A, NKE-2632/A, or NKE-2632-H is connected as the radar antenna.) | Set the motor driver circuit correctly. [Memo] For setting the motor driver circuit, always request the work to the specialized service person. Before starting the work, turn off the power supply of the display unit. Otherwise, an unexpected accident may occur. |
| | The radar antenna rotation unit is frozen. | De-freeze the frozen section by using the neck heater option. |
| | Strong wind of relative wind velocity exceeding 100kt (about 51.5m/s) is blowing. | When strong wind of relative wind velocity exceeding 100kt is blowing, the radar antenna does not rotate due to the protection function. |
| | The radar antenna is faulty. | Make a request to the distributor for repair. |
| | The interface circuit (CMH-2452) is faulty. | Make a request to the distributor for repair. |
| | The internal wiring is faulty. | Make a request to the distributor for repair. |
| | The power supply unit (NDB-945) inside of the processing unit is faulty. | Make a request to the distributor for repair. |
| | The processing unit (NDC-1678/A) is faulty. | Make a request to the distributor for repair. |
| No radar image is displayed. | The connection with the radar antenna is abnormal. | Check the connection with the radar antenna. |
| | The GAIN value is set to the minimum. | Set a proper value for GAIN. |
| | The SEA/RAIN value is set to the maximum. | Set a proper value for SEA/RAIN. |
| | The magnetron is deteriorated significantly. (Case where a radar antenna that uses a magnetron is connected) | Replace the magnetron. [Memo] For magnetron replacement, always request the work to the specialized service person. Before starting the work, turn off the power supply of the display unit. Otherwise, an unexpected accident may occur. |
| | The radar antenna is faulty. | Make a request to the distributor for repair. |
| | The internal wiring is faulty. | Make a request to the distributor for repair. |
| | The power supply (NDB-945) inside of the processing unit is faulty. | Make a request to the distributor for repair. |
| | The processing unit (NDC-1678/A) is faulty. | Make a request to the distributor for repair. |

| Symptom | Cause | Action |
|--|--|--|
| Radar images cannot be tuned. | The magnetron is deteriorated significantly. (Case where an radar antenna that uses a magnetron is connected) | Replace the magnetron. [Memo] For magnetron replacement, always request the work to the specialized service person. Before starting the work, turn off the power supply of the display unit. Otherwise, an unexpected accident may occur. |
| | Coarse tuning adjustment has not been performed correctly. | Perform coarse tuning adjustment correctly. |
| | A solid-state radar antenna is connected. | Tuning bar is not displayed for a solid-state radar antenna. |
| The azimuth of the radar image is not displayed correctly. | Azimuth is not set correctly. | Set the azimuth correctly. |
| | CCRP is not set correctly. | Set CCRP correctly. |
| | The GPS radar antenna position is not set correctly. | Set the GPS radar antenna position correctly. |
| The range of the radar image is not displayed correctly. | The range is not set correctly. | Set the range correctly. |
| | CCRP is not set correctly. | Set CCRP correctly. |
| | The GPS radar antenna position is not set correctly. | Set the GPS radar antenna position correctly. |
| Interswitch does not function. | Power for the interswitch is not turned on. | Turn on the power for the interswitch. |
| | The connection with the interswitch is abnormal. | Check the connection with the interswitch. |
| | The interswitch is faulty. | Make a request to the distributor for repair. |
| | The terminal board circuit (CQD-2322) is faulty. | Make a request to the distributor for repair. |
| | The internal wiring is faulty. | Make a request to the distributor for repair. |
| | The processing unit (NDC-1678/A) is faulty. | Make a request to the distributor for repair. |
| If the power supply is turned off, the trail data is cleared without being stored. | The processing unit (NDC-1678/A) is faulty. | Make a request to the distributor for repair. |

| Symptom | Cause | Action |
|--|---|--|
| Radar images cannot be superimposed. | The connection with the radar antenna is abnormal. | Check the connection with the radar antenna. |
| | The connection with the radar indicator is abnormal. | Check the connection with the radar indicator. |
| | The internal wiring is faulty. | Make a request to the distributor for repair. |
| | The processing unit (NDC-1678/A) is faulty. | Make a request to the distributor for repair. |
| The following popup window is displayed. System has detected an error. Turn the power off and on again. | A communication error occurred. | Close the popup window and after checking that there is no problem even if the power of this equipment is turned off, turn off the power once and turn on the power again. |
| The following popup window is displayed. Marine VHF radio does not respond. Check the connection with the equipment. | The power supply for the VHF or HUB is not turned on. There is a problem with the connection of a VHF LAN cable. | Check the power supply of the VHF or HUB. Check the connection of a LAN cable. |

16.4 After-Sale Services

16.4.1 About the retaining period of service parts

The retaining period of the performance-critical parts for servicing this product (parts required to maintain the functionality of the product) is 10 years after the discontinuation of production.

16.4.2 When requesting a repair

If you suspect a failure, please read "16.3 Troubleshooting" thoroughly and check the unit again.

If you still detect abnormality, stop using the product and contact your sales representative, our sales department, nearest branch office or sales office.

- **Repair during the warranty period:** If a failure occurs in the course of using the product correctly according to the explanations and instructions in the Instruction Manual, your sales representative or our company shall repair the product at no charge. However, repairs of failures caused by misuse, negligence, or act of God such as natural disasters and fire shall be chargeable.
- **If the warranty period has expired:** If functionality can be recovered by repair, repair shall be made by the request of the customer for a fee.
- **Please provide the following information:**
 - Product name, model name, manufacturing date, serial number
 - Description of abnormality (as detail as possible) (Please refer to the next page "Radar Failure Checklist.")
 - Business name or organisation name, address, phone number

16.4.3 Recommendation of inspection and maintenance

Although it depends on the usage state, performance may deteriorate by change in parts over time, Separately from regular care, inspection and maintenance are recommended.

Regarding inspection and maintenance, please contact your sales representative, our sales department, nearest branch office or sales office.

Please note that there is a charge for inspection and maintenance.

If you have questions regarding after-sale services, please inquire your sales representative, our sales department, nearest branch office or sales office.

Radar Failure Checklist

[Important] Before ordering a repair, please check and fill in the following items and then contact the applicable repair office.

If there are unknown items, please contact the ship and fill in as accurate as possible.

Ship Name: _____ Phone: _____ Fax: _____

Integrated Radar Model Name: JMR- _____ Serial Number: _____

(Please fill in all digits accurately.)

(1) Check the following items sequentially and circle either YES or NO for each item.

If none is applicable, please write down the specific reason in No. (18) Other description.

(2) If any of check items (1) through (5) is NO, please check the fuses of the equipment. (See "16.1.3 Fuse inspection.")

(3) Check items (4) through (17) with transmission (TX) ON.

* It may not be possible to use (14), (15) and (17) unless options and external devices are not connected; if they are not connected, it is not necessary to answer these items.

| No. | Check Item | Result | |
|-------|--|--------|----|
| | | YES | NO |
| (1) | The power turns On. (The light of the operation unit illuminates.) | | |
| (2) | The unit is placed in the standby state several minutes after turning the power On. | | |
| (3) | When the power is turned On (or transmission On), something is displayed on the LCD/LED monitor. (Illuminates) | | |
| (4) | When transmission (TX) is turned On, the Radar antenna rotates. (Check all of the following items with transmission On.) | | |
| (5) | Magnetron current flows. (See the Instruction Manual.) | | |
| (6) | Tuning can be performed. (Check in a range of 6NM or above.) | | |
| (7) | Fixed markers are displayed. | | |
| (8) | The VRM is displayed. | | |
| (9) | White noise is displayed with minimum Sea and Rain, maximum Gain, IR-Off and range 48NM. | | |
| (10) | Target reflection echoes are displayed, | | |
| (11) | The sensitivity of reflection echoes is normal. | | |
| (12) | The EBL is displayed. | | |
| (13) | The cursor symbols move. | | |
| *(14) | The GYRO course can be set up and is displayed normally. | | |
| *(15) | The LOG speed is displayed normally. | | |
| (16) | The target tracking function operates normally. | | |
| *(17) | If the straight mode (II) is switched to the cross mode (X) when an interswitch is provided, the failed (NO) items in (1) through (16) above are swapped between the right and left display units. | | |
| (18) | Other description (error messages, etc.) | | |
| | | | |

16.4.4 Extending the functions

The functions that are available for this equipment can be extended.

To extend a function, new licence information (file) must be obtained and imported to this equipment. For function extension, please request to our sales department or our branch office, sales office, or agent near your premises.

Memo

Expandable functions are as follows.

- Availability of plotter function
- Extension of displayed TT symbol (Extending from 30 to 100)
- Extension of displayed AIS symbol (Extending from 180 to 1000)

16.4.4.1 Importing the licence information

Import the licence information that was obtained (licence file) to this equipment via a USB memory device.

Connect the USB memory device in which the licence information is stored.

1 Press the Power button of the operation unit.

The Power button is lit. After a short time, the Mode Selection screen is displayed.

2 Click on the password input section.

A password input dialogue is displayed.

3 Enter the password, 9380.

The [Import Licence] dialogue is displayed.

4 Click on the [Browse] button.

The [System] dialogue is displayed.

5 Select the name of the licence file stored in the USB memory device (example: JRCMRADAR.lcn) and click on the [OK] button.

The [System] dialogue is closed.

6 Click on the [Import] button.

When import is completed, a confirmation dialogue box appears.

Close the dialogue box by clicking on the [OK] button.

7 Close the [Import Licence] dialogue by clicking on the [x] button to return to the Mode Selection screen.

In this case, a new licence is adopted.



Section 17 About Disposal

17.1 About Disposal of This Equipment

When disposing of this equipment, follow the regulations and/or rules of the local regulatory authority which has control over the location of disposal.

17.2 About Disposal of Used Magnetrons

A magnetron is used for the radar antennas (NKE-1130/A, NKE-2103, 2255) of this equipment.

- When a magnetron is replaced with a new one, please return the old magnetron to our distributor or sales office.

For more information, please inquire our dealer or sales office.

17.3 Chinese Version RoHS

有毒有害物质或元素的名称及含量

(Names & Content of toxic and hazardous substances or elements)

形式名(Type): JMR-5400 Series

名称(Name): RADAR

| 部件名称 (Part name) | 有毒有害物质或元素 (Toxic and Hazardous Substances and Elements) | | | | | |
|--|--|-----------|-----------|---------------|---------------|-----------------|
| | 铅 (Pb) | 汞 (Hg) | 镉 (Cd) | 六价铬 (Cr6+) | 多溴联苯 (PBB) | 多溴二苯醚 (PBDE) |
| 雷达天线单元 (Scanner Unit) | × | × | × | × | ○ | ○ |
| 主船内装置 (Inboard Unit) · 显示装置 (Display Unit) · 键盘装置 (Operation Unit) · 信号处理装置 (RADAR Process Unit) | × | ○ | × | × | ○ | ○ |
| 外部设备 (Peripherals) · 选择 (Options) · 电线类 (Cables) · 手册 (Documents) | × | ○ | × | × | ○ | ○ |
| <p>○: 表示该有毒有害物质在该部件所有均质材料中的含量均在 SJ/T11306-2006 标准规定的限量要求以下。 (Indicates that this toxic, or hazardous substance contained in all of the homogeneous materials for this part is below the requirement in SJ/T11363-2006.)</p> <p>×: 表示该有毒有害物质至少在该部件的某一均质材料中的含量超出 SJ/T11363-2006 标准规定的限量要求。 (Indicates that this toxic or hazardous substance contained in at least one of the homogeneous materials used for this part is above the limit requirement in SJ/T 11363-2006.)</p> | | | | | | |

Section 18 Specifications

18.1 JMR-5404-X

| GENERAL SPECIFICATION | JMR-5404-X |
|--|---|
| Class of emission | P0N |
| Display | Colour Raster Scan |
| Screen | 19inch LCD (Effective diameter of RADAR: more than 250mm) / 26inch LCD(Effective diameter of RADAR: more than 320mm) |
| Range Scale | 0.125/0.25/0.5/0.75/1.5/3/6/12/24/48/96 NM |
| Range Resolution | Less than 30m |
| Minimum Detection Range | Less than 40m |
| Bearing Accuracy | Less than 1° |
| Bearing Indication | Relative motion mode: North UP/Course UP/Head UP True motion mode: North UP/Course UP |
| Ambient Condition | Scanner Unit: -25°C to +55°C (Storage -25°C to +70°C) |
| - Operating Temperature | Other Units: -15°C to +55°C |
| Ambient Condition | 93% at +40°C |
| - Relative Humidity | |
| Ambient Condition | 2 to 13.2Hz: Amplitude ±1mm ±10% |
| - Vibration | 13.2 to 100Hz: Acceleration 7m/s ² |
| Power Supply Input | 24VDC |
| Power Consumption | NWZ-214 : Typical 200W Max wind speed 200W NWZ-208 : Typical 250W Max wind speed 250W |
| Power Supply Voltage Fluctuation | DC input +30%/-10% |
| Pre Heating Time | Within 4 minutes |
| From standby to transmit | Within 5 seconds |
| Scanner Unit | NKE-2043 |
| See Section 18.14 | |
| Display Unit | |
| Process Unit | NDC-1678/A |
| Standard Operation Unit | NCE-5794 |
| Display | NWZ-208/214 |
| See Section 18.31/18.32 | |
| Option Unit | |
| Trackball / Keyboard Operation Unit | NCE-5605/NCE-5625 |
| Trackball/Keyboard OPERATION UNIT DESKTOP FRAME RACK | CWB-1596 |
| Sensor LAN Switch Unit | NQA-2443/A |
| 19-inch / 26inch DESKTOP FRAME RACK | CWB-1659/1660 |
| Inter Switch Unit | NQE-3141-4A NQE-3141-8A |
| Power Control Unit | NQE-3167 |
| Junction Box | NQE-1143 (CMH-2370) |
| Rectifier | NBA-5111 |
| NSK Unit | NCT-4106A |
| MAXIMUM CABLE LENGTH | |
| Display to scanner unit | 30m |
| SAFE DISTANCE FOR STANDARD COMPASS | |
| Scanner Unit | 1.5m |
| Display Unit | 0.5m |
| SAFE DISTANCE FOR STEERING COMPASS | |
| Scanner Unit | 0.9m |
| Display Unit | 0.3m |

18.2 JMR-5406-X

| GENERAL SPECIFICATION | | JMR-5406-X |
|--|---|------------|
| Class of emission | P0N | |
| Display | Colour Raster Scan | |
| Screen | 19inch LCD (Effective diameter of RADAR: more than 250mm) / 26inch LCD(Effective diameter of RADAR: more than 320mm) | |
| Range Scale | 0.125/0.25/0.5/0.75/1.5/3/6/12/24/48/96 NM | |
| Range Resolution | Less than 30m | |
| Minimum Detection Range | Less than 40m | |
| Bearing Accuracy | Less than 1° | |
| Bearing Indication | Relative motion mode: North UP/Course UP/Head UP True motion mode: North UP/Course UP | |
| Ambient Condition | Scanner Unit: -25°C to +55°C (Storage -25°C to +70°C) Other Units: -15°C to +55°C | |
| - Operating Temperature | | |
| Ambient Condition | 93% at +40°C | |
| - Relative Humidity | | |
| Ambient Condition | 2 to 13.2Hz: Amplitude ±1mm ±10% | |
| - Vibration | 13.2 to 100Hz: Acceleration 7m/s ² | |
| Power Supply Input | 24VDC | |
| Power Consumption | NWZ-214 : Typical 200W Max wind speed 300W NWZ-208 : Typical 250W Max wind speed 350W | |
| Power Supply Voltage Fluctuation | DC input +30%/-10% | |
| Pre Heating Time | Within 4 minutes | |
| From standby to transmit | Within 5 seconds | |
| Scanner Unit | NKE-2063A | |
| See Section 18.15 | | |
| Display Unit | | |
| Process Unit | NDC-1678/A | |
| Standard Operation Unit | NCE-5794 | |
| Display | NWZ-208/214 | |
| See Section 18.31/18.32 | | |
| Option Unit | | |
| Trackball / Keyboard Operation Unit | NCE-5605/NCE-5625 | |
| Trackball/Keyboard OPERATION UNIT DESKTOP FRAME RACK | CWB-1596 | |
| Sensor LAN Switch Unit | NQA-2443/A | |
| 19-inch / 26inch DESKTOP FRAME RACK | CWB-1659/1660 | |
| Inter Switch Unit | NQE-3141-4A NQE-3141-8A | |
| Power Control Unit | NQE-3167 | |
| Junction Box | NQE-1143 (CMH-2370) | |
| Rectifier | NBA-5111 | |
| NSK Unit | NCT-4106A | |
| MAXIMUM CABLE LENGTH | | |
| Display to scanner unit | 30m | |
| SAFE DISTANCE FOR STANDARD COMPASS | | |
| Scanner Unit | 1.7m | |
| Display Unit | 0.5m | |
| SAFE DISTANCE FOR STEERING COMPASS | | |
| Scanner Unit | 1.1m | |
| Display Unit | 0.3m | |

18.3 JMR-5410-4X

| GENERAL SPECIFICATION | | JMR-5410-4X |
|--|--|-------------|
| Class of emission | P0N | |
| Display | Colour Raster Scan | |
| Screen | 19inch LCD (Effective diameter of RADAR: more than 250mm) / 26inch LCD(Effective diameter of RADAR: more than 320mm) *1 | |
| Range Scale | 0.125/0.25/0.5/0.75/1.5/3/6/12/24/48/96 NM | |
| Range Resolution | Less than 30m | |
| Minimum Detection Range | Less than 40m | |
| Bearing Accuracy | Less than 1° | |
| Bearing Indication | Relative motion mode: North UP/Course UP/Head UP True motion mode: North UP/Course UP | |
| Ambient Condition | Scanner Unit: -25°C to +55°C (Storage -25°C to +70°C) | |
| - Operating Temperature | Other Units: -15°C to +55°C | |
| Ambient Condition | 93% at +40°C | |
| - Relative Humidity | | |
| Ambient Condition | 2 to 13.2Hz: Amplitude ±1mm ±10% | |
| - Vibration | 13.2 to 100Hz: Acceleration 7m/s ² | |
| Power Supply Input | 24VDC | |
| Power Consumption | NWZ-214 : Typical 250W Max wind speed 350W NWZ-208 : Typical 250W Max wind speed 400W | |
| Power Supply Voltage Fluctuation | DC input +30%/-10% | |
| Pre Heating Time | Within 4 minutes | |
| From standby to transmit | Within 5 seconds | |
| Scanner Unit | NKE-2103-4 | |
| See Section 18-16 | | |
| Performance Monitor | NJU-85 | |
| See Section 18.23 | | |
| Display Unit | | |
| Process Unit | NDC-1678/A | |
| Standard Operation Unit | NCE-5794 | |
| Display | NWZ-208/214 | |
| See Section 18.31/18.32 | | |
| Option Unit | | |
| Trackball / Keyboard Operation Unit | NCE-5605/NCE-5625 | |
| Trackball/Keyboard OPERATION UNIT DESKTOP FRAME RACK | CWB-1596 | |
| Sensor LAN Switch Unit | NQA-2443/A | |
| 19-inch / 26inch DESKTOP FRAME RACK | CWB-1659/1660 | |
| Inter Switch Unit | NQE-3141-4A NQE-3141-8A | |
| Power Control Unit | NQE-3167 | |
| Junction Box | NQE-1143 (CMH-2370) | |
| Rectifier | NBA-5111 | |
| NSK Unit | NCT-4106A | |
| MAXIMUM CABLE LENGTH | | |
| Display to scanner unit | 65m | |
| SAFE DISTANCE FOR STANDARD COMPASS | | |
| Scanner Unit | 2.4m | |
| Display Unit | 0.5m | |
| SAFE DISTANCE FOR STEERING COMPASS | | |
| Scanner Unit | 1.8m | |
| Display Unit | 0.3m | |

*1: When used as CAT1 / 1H, only 26 inch LCD monitor NWZ-208 can be selected.

18.4 JMR-5410-4XH

| GENERAL SPECIFICATION | | JMR-5410-4XH |
|--|--|--|
| Class of emission | | P0N |
| Display | | Colour Raster Scan |
| Screen | | 19inch LCD (Effective diameter of RADAR: more than 250mm) / 26inch LCD(Effective diameter of RADAR: more than 320mm) *1 |
| Range Scale | | 0.125/0.25/0.5/0.75/1.5/3/6/12/24/48/96 NM |
| Range Resolution | | Less than 30m |
| Minimum Detection Range | | Less than 40m |
| Bearing Accuracy | | Less than 1° |
| Bearing Indication | | Relative motion mode: North UP/Course UP/Head UP True motion mode: North UP/Course UP |
| Ambient Condition | | Scanner Unit: -25°C to +55°C (Storage -25°C to +70°C) |
| - Operating Temperature | | Other Units: -15°C to +55°C |
| Ambient Condition | | 93% at +40°C |
| - Relative Humidity | | |
| Ambient Condition | | 2 to 13.2Hz: Amplitude $\pm 1\text{mm} \pm 10\%$ |
| - Vibration | | 13.2 to 100Hz: Acceleration 7m/s^2 |
| Power Supply Input | | 24VDC |
| Power Consumption | | NWZ-214 : Typical 250W, 450W at maximum wind speed NWZ-208 : Typical 250W, 500W at maximum wind speed. |
| Power Supply Voltage Fluctuation | | DC input +30%/-10% |
| Pre Heating Time | | Within 4 minutes |
| From standby to transmit | | Within 5 seconds |
| Scanner Unit | | NKE-2103-4HS |
| See Section 18.16 | | |
| Performance Monitor | | NJU-85 |
| See Section 18.22 | | |
| Display Unit | | |
| Process Unit | | NDC-1678/A |
| Standard Operation Unit | | NCE-5794 |
| Display | | NWZ-208/214 |
| See Section 18.31/18.32 | | |
| Option Unit | | |
| Trackball / Keyboard Operation Unit | | NCE-5605/NCE-5625 |
| Trackball/Keyboard OPERATION UNIT DESKTOP FRAME RACK | | CWB-1596 |
| Sensor LAN Switch Unit | | NQA-2443/A |
| 19-inch / 26inch DESKTOP FRAME RACK | | CWB-1659/1660 |
| Inter Switch Unit | | NQE-3141-4A NQE-3141-8A |
| Power Control Unit | | NQE-3167 |
| Junction Box | | NQE-1143 (CMH-2370) |
| Rectifier | | NBA-5111 |
| NSK Unit | | NCT-4106A |
| MAXIMUM CABLE LENGTH | | |
| Display to scanner unit | | 65m |
| SAFE DISTANCE FOR STANDARD COMPASS | | |
| Scanner Unit | | 2.4m |
| Display Unit | | 0.5m |
| SAFE DISTANCE FOR STEERING COMPASS | | |
| Scanner Unit | | 1.8m |
| Display Unit | | 0.3m |

*1: When used as CAT1 / 1H, only 26 inch LCD monitor NWZ-208 can be selected.

18.5 JMR-5410-6X

| GENERAL SPECIFICATION | | JMR-5410-6X |
|--|--|-------------|
| Class of emission | P0N | |
| Display | Colour Raster Scan | |
| Screen | 19inch LCD (Effective diameter of RADAR: more than 250mm) / 26inch LCD(Effective diameter of RADAR: more than 320mm) *1 | |
| Range Scale | 0.125/0.25/0.5/0.75/1.5/3/6/12/24/48/96 NM | |
| Range Resolution | Less than 30m | |
| Minimum Detection Range | Less than 40m | |
| Bearing Accuracy | Less than 1° | |
| Bearing Indication | Relative motion mode: North UP/Course UP/Head UP True motion mode: North UP/Course UP | |
| Ambient Condition | Scanner Unit: -25°C to +55°C (Storage -25°C to +70°C) | |
| - Operating Temperature | Other Units: -15°C to +55°C | |
| Ambient Condition | 93% at +40°C | |
| - Relative Humidity | | |
| Ambient Condition | 2 to 13.2Hz: Amplitude $\pm 1\text{mm} \pm 10\%$ | |
| - Vibration | 13.2 to 100Hz: Acceleration 7m/s^2 | |
| Power Supply Input | 24VDC | |
| Power Consumption | NWZ-214 : Typical 250W Max wind speed 350W NWZ-208 : Typical 250W Max wind speed 400W | |
| Power Supply Voltage Fluctuation | DC input +30%/-10% | |
| Pre Heating Time | Within 4 minutes | |
| From standby to transmit | Within 5 seconds | |
| Scanner Unit | NKE-2103-6 | |
| See Section 18.16 | | |
| Performance Monitor | NJU-85 | |
| See Section 18.22 | | |
| Display Unit | | |
| Process Unit | NDC-1678/A | |
| Standard Operation Unit | NCE-5794 | |
| Display | NWZ-208/214 | |
| See Section 18.31/18.32 | | |
| Option Unit | | |
| Trackball / Keyboard Operation Unit | NCE-5605/NCE-5625 | |
| Trackball/Keyboard OPERATION UNIT DESKTOP FRAME RACK | CWB-1596 | |
| Sensor LAN Switch Unit | NQA-2443/A | |
| 19-inch / 26inch DESKTOP FRAME RACK | CWB-1659/1660 | |
| Inter Switch Unit | NQE-3141-4A NQE-3141-8A | |
| Power Control Unit | NQE-3167 | |
| Junction Box | NQE-1143 (CMH-2370) | |
| Rectifier | NBA-5111 | |
| NSK Unit | NCT-4106A | |
| MAXIMUM CABLE LENGTH | | |
| Display to scanner unit | 65m | |
| SAFE DISTANCE FOR STANDARD COMPASS | | |
| Scanner Unit | 2.4m | |
| Display Unit | 0.5m | |
| SAFE DISTANCE FOR STEERING COMPASS | | |
| Scanner Unit | 1.8m | |
| Display Unit | 0.3m | |

*1: When used as CAT1 / 1H, only 26 inch LCD monitor NWZ-208 can be selected.

18.6 JMR-5410-6XH

| GENERAL SPECIFICATION | | JMR-5410-6XH |
|--|--|--|
| Class of emission | | P0N |
| Display | | Colour Raster Scan |
| Screen | | 19inch LCD (Effective diameter of RADAR: more than 250mm) / 26inch LCD(Effective diameter of RADAR: more than 320mm) *1 |
| Range Scale | | 0.125/0.25/0.5/0.75/1.5/3/6/12/24/48/96 NM |
| Range Resolution | | Less than 30m |
| Minimum Detection Range | | Less than 40m |
| Bearing Accuracy | | Less than 1° |
| Bearing Indication | | Relative motion mode: North UP/Course UP/Head UP True motion mode: North UP/Course UP |
| Ambient Condition | | Scanner Unit: -25°C to +55°C (Storage -25°C to +70°C) |
| - Operating Temperature | | Other Units: -15°C to +55°C |
| Ambient Condition | | 93% at +40°C |
| - Relative Humidity | | |
| Ambient Condition | | 2 to 13.2Hz: Amplitude ±1mm ±10% |
| - Vibration | | 13.2 to 100Hz: Acceleration 7m/s ² |
| Power Supply Input | | 24VDC |
| Power Consumption | | NWZ-214 : Typical 250W, 450W at maximum wind speed NWZ-208 : Typical 250W, 500W at maximum wind speed. |
| Power Supply Voltage Fluctuation | | DC input +30%/-10% |
| Pre Heating Time | | Within 4 minutes |
| From standby to transmit | | Within 5 seconds |
| Scanner Unit | | NKE-2103-6HS |
| See Section 18.16 | | |
| Performance Monitor | | NJU-85 |
| See Section 18.22 | | |
| Display Unit | | |
| Process Unit | | NDC-1678/A |
| Standard Operation Unit | | NCE-5794 |
| Display | | NWZ-208/214 |
| See Section 18.31/18.32 | | |
| Option Unit | | |
| Trackball/Keyboard Operation Unit | | NCE-5605/NCE-5625 |
| Trackball/Keyboard OPERATION UNIT DESKTOP FRAME RACK | | CWB-1596 |
| Sensor LAN Switch Unit | | NQA-2443/A |
| 19inch/26inch DESKTOP FRAME RACK | | CWB-1659/1660 |
| Inter Switch Unit | | NQE-3141-4A NQE-3141-8A |
| Power Control Unit | | NQE-3167 |
| Junction Box | | NQE-1143 (CMH-2370) |
| Rectifier | | NBA-5111 |
| NSK Unit | | NCT-4106A |
| MAXIMUM CABLE LENGTH | | |
| Display to scanner unit | | 65m |
| SAFE DISTANCE FOR STANDARD COMPASS | | |
| Scanner Unit | | 2.4m |
| Display Unit | | 0.5m |
| SAFE DISTANCE FOR STEERING COMPASS | | |
| Scanner Unit | | 1.8m |
| Display Unit | | 0.3m |

*1: When used as CAT1 / 1H, only 26 inch LCD monitor NWZ-208 can be selected.

18.7 JMR-5425-7X

| GENERAL SPECIFICATION | | JMR-5425-7X |
|---|--|--|
| Class of emission | | P0N |
| Display | | Colour Raster Scan |
| Screen | | 19inch LCD (Effective diameter of RADAR: more than 250mm) / 26inch LCD(Effective diameter of RADAR: more than 320mm) *1 |
| Range Scale | | 0.125/0.25/0.5/0.75/1.5/3/6/12/24/48/96 NM |
| Range Resolution | | Less than 30m |
| Minimum Detection Range | | Less than 40m |
| Bearing Accuracy | | Less than 1° |
| Bearing Indication | | Relative motion mode: North UP/Course UP/Head UP True motion mode: North UP/Course UP |
| Ambient Condition | | Scanner Unit: -25°C to +55°C (Storage -25°C to +70°C) |
| - Operating Temperature | | Other Units: -15°C to +55°C |
| Ambient Condition | | 93% at +40°C |
| - Relative Humidity | | |
| Ambient Condition | | 2 to 13.2Hz: Amplitude ±1mm ±10% |
| - Vibration | | 13.2 to 100Hz: Acceleration 7m/s ² |
| Power Supply Input | | 24VDC |
| Power Consumption | | NWZ-214 : Typical 250W, 400W at maximum wind speed NWZ-208 : Typical 250W, 450W at maximum wind speed. |
| Power Supply Voltage Fluctuation | | DC input +30%/-10% |
| Pre Heating Time | | Within 4 minutes |
| From standby to transmit | | Within 5 seconds |
| Scanner Unit | | NKE-2255-7 |
| See Section 18.17 | | |
| Performance Monitor | | NJU-97 (Built-in : Option) |
| See Section 18.23 | | |
| Display Unit | | |
| Process Unit | | NDC-1678/A |
| Standard Operation Unit | | NCE-5794 |
| Display | | NWZ-208/214 |
| See Section 18.31/18.32 | | |
| Option Unit | | |
| Scanner Unit Deicing Heater | | CCK-1105 |
| Trackball/Keyboard Operation Unit | | NCE-5605/NCE-5625 |
| Trackball/ Keyboard OPERATION UNIT DESKTOP FRAME RACK | | CWB-1596 |
| Sensor LAN Switch Unit | | NQA-2443/A |
| 19-inch/26-inch DESKTOP FRAME RACK | | CWB-1659/1660 |
| Inter Switch Unit | | NQE-3141-4A NQE-3141-8A |
| Power Control Unit | | NQE-3167 |
| Junction Box | | NQE-1143 (CMH-2370) |
| Rectifier | | NBA-5111 |
| NSK Unit | | NCT-4106A |
| MAXIMUM CABLE LENGTH | | |
| Display to scanner unit | | 65m |
| SAFE DISTANCE FOR STANDARD COMPASS | | |
| Scanner Unit | | 1.1m |
| Display Unit | | 0.5m |
| SAFE DISTANCE FOR STEERING COMPASS | | |
| Scanner Unit | | 0.7m |
| Display Unit | | 0.3m |

*1: When used as CAT1 / 1H, only 26 inch LCD monitor NWZ-208 can be selected.

18.8 JMR-5425-9X

| GENERAL SPECIFICATION | | JMR-5425-9X |
|--|--|--|
| Class of emission | | P0N |
| Display | | Colour Raster Scan |
| Screen | | 19inch LCD (Effective diameter of RADAR: more than 250mm) / 26inch LCD(Effective diameter of RADAR: more than 320mm) *1 |
| Range Scale | | 0.125/0.25/0.5/0.75/1.5/3/6/12/24/48/96 NM |
| Range Resolution | | Less than 30m |
| Minimum Detection Range | | Less than 40m |
| Bearing Accuracy | | Less than 1° |
| Bearing Indication | | Relative motion mode: North UP/Course UP/Head UP True motion mode: North UP/Course UP |
| Ambient Condition | | Scanner Unit: -25°C to +55°C (Storage -25°C to +70°C) |
| - Operating Temperature | | Other Units: -15°C to +55°C |
| Ambient Condition | | 93% at +40°C |
| - Relative Humidity | | |
| Ambient Condition | | 2 to 13.2Hz: Amplitude ±1mm ±10% |
| - Vibration | | 13.2 to 100Hz: Acceleration 7m/s ² |
| Power Supply Input | | 24VDC |
| Power Consumption | | NWZ-214 : Typical 250W, 500W at maximum wind speed NWZ-208 : Typical 250W, 550W at maximum wind speed. |
| Power Supply Voltage Fluctuation | | DC input +30%/-10% |
| Pre Heating Time | | Within 4 minutes |
| From standby to transmit | | Within 5 seconds |
| Scanner Unit | | NKE-2255-9 |
| See Section 18.17 | | |
| Performance Monitor | | NJU-97 (Built-in : Option) |
| See Section 18.23 | | |
| Display Unit | | |
| Process Unit | | NDC-1678/A |
| Standard Operation Unit | | NCE-5794 |
| Display | | NWZ-208/214 |
| See Section 18.31/18.32 | | |
| Option Unit | | |
| Scanner Unit Deicing Heater | | CCK-1105 |
| Trackball/Keyboard Operation Unit | | NCE-5605/NCE-5625 |
| Trackball/Keyboard OPERATION UNIT DESKTOP FRAME RACK | | CWB-1596 |
| Sensor LAN Switch Unit | | NQA-2443/A |
| 19-inch/26-inch DESKTOP FRAME RACK | | CWB-1659/1660 |
| Inter Switch Unit | | NQE-3141-4A NQE-3141-8A |
| Power Control Unit | | NQE-3167 |
| Junction Box | | NQE-1143 (CMH-2370) |
| Rectifier | | NBA-5111 |
| NSK Unit | | NCT-4106A |
| MAXIMUM CABLE LENGTH | | |
| Display to scanner unit | | 65m |
| SAFE DISTANCE FOR STANDARD COMPASS | | |
| Scanner Unit | | 1.1m |
| Display Unit | | 0.5m |
| SAFE DISTANCE FOR STEERING COMPASS | | |
| Scanner Unit | | 0.7m |
| Display Unit | | 0.3m |

*1: When used as CAT1 / 1H, only 26 inch LCD monitor NWZ-208 can be selected.

18.9 JMR-5425-6XH

| GENERAL SPECIFICATION | | JMR-5425-6XH |
|--|--|--|
| Class of emission | | P0N |
| Display | | Colour Raster Scan |
| Screen | | 19inch LCD (Effective diameter of RADAR: more than 250mm) / 26inch LCD(Effective diameter of RADAR: more than 320mm) *1 |
| Range Scale | | 0.125/0.25/0.5/0.75/1.5/3/6/12/24/48/96 NM |
| Range Resolution | | Less than 30m |
| Minimum Detection Range | | Less than 40m |
| Bearing Accuracy | | Less than 1° |
| Bearing Indication | | Relative motion mode: North UP/Course UP/Head UP True motion mode: North UP/Course UP |
| Ambient Condition | | Scanner Unit: -25°C to +55°C (Storage -25°C to +70°C) |
| - Operating Temperature | | Other Units: -15°C to +55°C |
| Ambient Condition | | 93% at +40°C |
| - Relative Humidity | | |
| Ambient Condition | | 2 to 13.2Hz: Amplitude ±1mm ±10% |
| - Vibration | | 13.2 to 100Hz: Acceleration 7m/s ² |
| Power Supply Input | | 24VDC |
| Power Consumption | | NWZ-214 : Typical 250W, 450W at maximum wind speed NWZ-208 : Typical 300W, 500W at maximum wind speed. |
| Power Supply Voltage Fluctuation | | DC input +30%/-10% |
| Pre Heating Time | | Within 4 minutes |
| From standby to transmit | | Within 5 seconds |
| Scanner Unit | | NKE-2255-6HS |
| See Section 18.9 | | |
| Performance Monitor | | NJU-97 (Built-in : Option) |
| See Section 18.23 | | |
| Display Unit | | |
| Process Unit | | NDC-1678/A |
| Standard Operation Unit | | NCE-5794 |
| Display | | NWZ-208/214 |
| See Section 18.31/18.32 | | |
| Option Unit | | |
| Scanner Unit Deicing Heater | | CCK-1105 |
| Trackball/Keyboard Operation Unit | | NCE-5605/NCE-5625 |
| Trackball/Keyboard OPERATION UNIT DESKTOP FRAME RACK | | CWB-1596 |
| Sensor LAN Switch Unit | | NQA-2443/A |
| 19-inch/26-inch DESKTOP FRAME RACK | | CWB-1659/1660 |
| Inter Switch Unit | | NQE-3141-4A NQE-3141-8A |
| Power Control Unit | | NQE-3167 |
| Junction Box | | NQE-1143 (CMH-2370) |
| Rectifier | | NBA-5111 |
| NSK Unit | | NCT-4106A |
| MAXIMUM CABLE LENGTH | | |
| Display to scanner unit | | 65m |
| SAFE DISTANCE FOR STANDARD COMPASS | | |
| Scanner Unit | | 1.1m |
| Display Unit | | 0.5m |
| SAFE DISTANCE FOR STEERING COMPASS | | |
| Scanner Unit | | 0.7m |
| Display Unit | | 0.3m |

*1: When used as CAT1 / 1H, only 26 inch LCD monitor NWZ-208 can be selected.

18.10JMR-5430-S

| GENERAL SPECIFICATION | JMR-5430-S |
|--|---|
| Class of emission | P0N |
| Display | Colour Raster Scan |
| Screen | 19inch LCD (Effective diameter of RADAR: more than 250mm) / 26inch LCD(Effective diameter of RADAR: more than 320mm) *1 |
| Range Scale | 0.125/0.25/0.5/0.75/1.5/3/6/12/24/48/96 NM |
| Range Resolution | Less than 30m |
| Minimum Detection Range | Less than 40m |
| Bearing Accuracy | Less than 1° |
| Bearing Indication | Relative motion mode: North UP/Course UP/Head UP True motion mode: North UP/Course UP |
| Ambient Condition | Scanner Unit: -25°C to +55°C (Storage -25°C to +70°C) |
| - Operating Temperature | Other Units: -15°C to +55°C |
| Ambient Condition | 93% at +40°C |
| - Relative Humidity | |
| Ambient Condition | 2 to 13.2Hz: Amplitude ±1mm ±10% |
| - Vibration | 13.2 to 100Hz: Acceleration 7m/s ² |
| Power Supply Input | 100 to 115VAC, 50/60Hz 1φ 220 to 240VAC, 50/60Hz 1φ 24VDC |
| Power Consumption | NWZ-214 : Typical 220W+300VA, 320W+1600VA at maximum wind speed NWZ-208 : Typical 270W+300VA, 370W+1600VA at maximum wind speed. |
| Power Supply Voltage Fluctuation | AC input ±10% DC input +30%/-10% |
| Pre Heating Time | Within 4 minutes |
| From standby to transmit | Within 5 seconds |
| Scanner Unit | NKE-1130/A |
| See Section 18.18 | |
| Performance Monitor | NJU-84 |
| See Section 18.21 | |
| Display Unit | |
| Process Unit | NDC-1678/A |
| Standard Operation Unit | NCE-5794 |
| Display | NWZ-208/214 |
| See Section 18.31/18.32 | |
| Standard Unit | |
| Rectifier | NBA-5111 |
| Option Unit | |
| Scanner Unit Deicing Heater | CHG-215 |
| Trackball/Keyboard Operation Unit | NCE-5605/NCE-5625 |
| Trackball/Keyboard OPERATION UNIT DESKTOP FRAME RACK | CWB-1596 |
| Sensor LAN Switch Unit | NQA-2443/A |
| 19-inch/26-inch DESKTOP FRAME RACK | CWB-1659/1660 |
| Inter Switch Unit | NQE-3141-4A NQE-3141-8A |
| Power Control Unit | NQE-3167 |
| Junction Box | NQE-1143 (CMH-2370) |
| Junction Box (Scanner unit connection) | NQA-3151A |
| NSK Unit | NCT-4106A |
| MAXIMUM CABLE LENGTH | |
| Display to scanner unit | 65m |
| SAFE DISTANCE FOR STANDARD COMPASS | |
| Scanner Unit | 5.1m |
| Display Unit | 0.5m |
| SAFE DISTANCE FOR STEERING COMPASS | |
| Scanner Unit | 2.7m |
| Display Unit | 0.3m |

*1: When used as CAT1 / 1H, only 26 inch LCD monitor NWZ-208 can be selected.

18.11 JMR-5472-S

| GENERAL SPECIFICATION | | JMR-5472-S |
|--|---|------------|
| Class of emission | P0N, Q0N | |
| Display | Colour Raster Scan | |
| Screen | 19inch LCD (Effective diameter of RADAR: more than 250mm) / 26inch LCD(Effective diameter of RADAR: more than 320mm) *1 | |
| Range Scale | 0.125/0.25/0.5/0.75/1.5/3/6/12/24/48/96 NM | |
| Range Resolution | Less than 30m | |
| Minimum Detection Range | Less than 40m | |
| Bearing Accuracy | Less than 1° | |
| Bearing Indication | Relative motion mode: North UP/Course UP/Head UP True motion mode: North UP/Course UP | |
| Ambient Condition | Scanner Unit: -25°C to +55°C (Storage -25°C to +70°C) | |
| - Operating Temperature | Other Units: -15°C to +55°C | |
| Ambient Condition | 93% at +40°C | |
| - Relative Humidity | | |
| Ambient Condition | 2 to 13.2Hz: Amplitude ±1mm ±10% | |
| - Vibration | 13.2 to 100Hz: Acceleration 7m/s ² | |
| Power Supply Input | 100 to 115VAC, 50/60Hz 1φ 220 to 240VAC, 50/60Hz 1φ 24VDC | |
| Power Consumption | NWZ-214 : Typical 100W+500VA, 200W+1700VA at maximum wind speed NWZ-208 : Typical 150W+500VA, 250W+1700VA at maximum wind speed. | |
| Power Supply Voltage Fluctuation | AC input ±10% DC input +30%/-10% | |
| Pre Heating Time | Within 4 minutes | |
| From standby to transmit | Within 5 seconds | |
| Scanner Unit | NKE-1632/A | |
| See Section 18.19 | | |
| Power Control Unit | NQE-3167 | |
| Performance Monitor | Built-in | |
| Display Unit | | |
| Process Unit | NDC-1678/A | |
| Standard Operation Unit | NCE-5794 | |
| Display | NWZ-208/214 | |
| See Section 18.31/18.32 | | |
| Option Unit | | |
| Scanner Unit Deicing Heater | CHG-235 | |
| Trackball/Keyboard Operation Unit | NCE-5605/NCE-5625 | |
| Trackball/Keyboard OPERATION UNIT DESKTOP FRAME RACK | CWB-1596 | |
| Sensor LAN Switch Unit | NQA-2443/A | |
| 19inch/26inch DESKTOP FRAME RACK | CWB-1659/1660 | |
| Inter Switch Unit | NQE-3141-4A NQE-3141-8A | |
| Junction Box | NQE-1143 (CMH-2370) | |
| Rectifier | NBA-5111 | |
| NSK Unit | NCT-4106A | |
| MAXIMUM CABLE LENGTH | | |
| Display to scanner unit | 65m | |
| SAFE DISTANCE FOR STANDARD COMPASS | | |
| Scanner Unit | 0.8m | |
| Display Unit | 0.5m | |
| SAFE DISTANCE FOR STEERING COMPASS | | |
| Scanner Unit | 0.5m | |
| Display Unit | 0.3m | |

*1: When used as CAT1 / 1H, only 26 inch LCD monitor NWZ-208 can be selected.

18.12JMR-5482-S

| GENERAL SPECIFICATION | | JMR-5482-S |
|--|---|------------|
| Class of emission | P0N, Q0N | |
| Display | Colour Raster Scan | |
| Screen | 19inch LCD (Effective diameter of RADAR: more than 250mm) / 26inch LCD(Effective diameter of RADAR: more than 320mm) *1 | |
| Range Scale | 0.125/0.25/0.5/0.75/1.5/3/6/12/24/48/96 NM | |
| Range Resolution | Less than 30m | |
| Minimum Detection Range | Less than 35m | |
| Bearing Accuracy | Less than 1° | |
| Bearing Indication | Relative motion mode: North UP/Course UP/Head UP True motion mode: North UP/Course UP | |
| Ambient Condition | Scanner Unit: -25°C to +55°C (Storage -25°C to +70°C) Other Units: -15°C to +55°C | |
| - Operating Temperature | | |
| Ambient Condition | 93% at +40°C | |
| - Relative Humidity | | |
| Ambient Condition | 2 to 13.2Hz: Amplitude ±1mm ±10% | |
| - Vibration | 13.2 to 100Hz: Acceleration 7m/s ² | |
| Power Supply Input | 100 to 115VAC, 50/60Hz 1φ 220 to 240VAC, 50/60Hz 1φ 24VDC | |
| Power Consumption | NWZ-214 : Typical 100W+400VA, 200W+1300VA at maximum wind speed NWZ-208 : Typical 150W+400VA, 250W+1300VA at maximum wind speed. | |
| Power Supply Voltage Fluctuation | AC input ±10% DC input +30%/-10% | |
| Pre Heating Time | Within 4 minutes | |
| From standby to transmit | Within 5 seconds | |
| Scanner Unit | NKE-2632/A | |
| See Section 18.20 | | |
| Power Control Unit | NQE-3167 | |
| Performance Monitor | Built-in | |
| Display Unit | | |
| Process Unit | NDC-1678/A | |
| Standard Operation Unit | NCE-5794 | |
| Display | NWZ-208/214 | |
| See Section 18.31/18.32 | | |
| Option Unit | | |
| Scanner Unit Deicing Heater | CHG-234 | |
| Trackball/Keyboard Operation Unit | NCE-5605/NCE-5625 | |
| Trackball/Keyboard OPERATION UNIT DESKTOP FRAME RACK | CWB-1596 | |
| Sensor LAN Switch Unit | NQA-2443/A | |
| 19-inch/26-inch DESKTOP FRAME RACK | CWB-1659/1660 | |
| Inter Switch Unit | NQE-3141-4A NQE-3141-8A | |
| Junction Box | NQE-1143 (CMH-2370) | |
| Rectifier | NBA-5111 | |
| NSK Unit | NCT-4106A | |
| MAXIMUM CABLE LENGTH | | |
| Display to scanner unit | 65m | |
| SAFE DISTANCE FOR STANDARD COMPASS | | |
| Scanner Unit | 0.8m | |
| Display Unit | 0.5m | |
| SAFE DISTANCE FOR STEERING COMPASS | | |
| Scanner Unit | 0.5m | |
| Display Unit | 0.3m | |

*1: When used as CAT1 / 1H, only 26 inch LCD monitor NWZ-208 can be selected.

18.13JMR-5482-SH

| GENERAL SPECIFICATION | | JMR-5482-SH |
|--|---|-------------|
| Class of emission | P0N, Q0N | |
| Display | Colour Raster Scan | |
| Screen | 19inch LCD (Effective diameter of RADAR: more than 250mm) / 26inch LCD(Effective diameter of RADAR: more than 320mm) *1 | |
| Range Scale | 0.125/0.25/0.5/0.75/1.5/3/6/12/24/48/96 NM | |
| Range Resolution | Less than 30m | |
| Minimum Detection Range | Less than 35m | |
| Bearing Accuracy | Less than 1° | |
| Bearing Indication | Relative motion mode: North UP/Course UP/Head UP True motion mode: North UP/Course UP | |
| Ambient Condition | Scanner Unit: -25°C to +55°C (Storage -25°C to +70°C) | |
| - Operating Temperature | Other Units: -15°C to +55°C | |
| Ambient Condition | 93% at +40°C | |
| - Relative Humidity | | |
| Ambient Condition | 2 to 13.2Hz: Amplitude ±1mm ±10% | |
| - Vibration | 13.2 to 100Hz: Acceleration 7m/s ² | |
| Power Supply Input | 100 to 115VAC, 50/60Hz 1φ 220 to 240VAC, 50/60Hz 1φ 24VDC | |
| Power Consumption | NWZ-214 : Typical 100W+500VA, 200W+1700VA at maximum wind speed NWZ-208 : Typical 150W+500VA, 250W+1700VA at maximum wind speed. | |
| Power Supply Voltage Fluctuation | AC input ±10% DC input +30%/-10% | |
| Pre Heating Time | Within 4 minutes | |
| From standby to transmit | Within 5 seconds | |
| Scanner Unit | NKE-2632-H | |
| See Section 18.20 | | |
| Power Control Unit | NQE-3167 | |
| Performance Monitor | Built-in | |
| Display Unit | | |
| Process Unit | NDC-1678/A | |
| Standard Operation Unit | NCE-5794 | |
| Display | NWZ-208/214 | |
| See Section 18.31/18.32 | | |
| Option Unit | | |
| Scanner Unit Deicing Heater | CHG-234 | |
| Trackball/Keyboard Operation Unit | NCE-5605/NCE-5625 | |
| Trackball/Keyboard OPERATION UNIT DESKTOP FRAME RACK | CWB-1596 | |
| Sensor LAN Switch Unit | NQA-2443/A | |
| 19inch/26inch DESKTOP FRAME RACK | CWB-1659/1660 | |
| Inter Switch Unit | NQE-3141-4A NQE-3141-8A | |
| Junction Box | NQE-1143 (CMH-2370) | |
| Rectifier | NBA-5111 | |
| NSK Unit | NCT-4106A | |
| MAXIMUM CABLE LENGTH | | |
| Display to scanner unit | 65m | |
| SAFE DISTANCE FOR STANDARD COMPASS | | |
| Scanner Unit | 0.6m | |
| Display Unit | 0.5m | |
| SAFE DISTANCE FOR STEERING COMPASS | | |
| Scanner Unit | 0.3m | |
| Display Unit | 0.3m | |

*1: When used as CAT1 / 1H, only 26 inch LCD monitor NWZ-208 can be selected.

18.14NKE-2043

| GENERAL SPECIFICATION | | NKE-2043 |
|--|---|----------|
| Dimension | Height 275 ×Diameter of radome 620 (mm) | |
| Mass | Approx. 10kg | |
| Polarization | Horizontal | |
| Horizontal beam width | 4° | |
| Vertical beam width | 25° | |
| Side lobe level | -21dB or less (less than ±10° from the main lobe) | |
| Revolution | Approx. 48 rpm | |
| Power Supply for Motor | 24VDC | |
| Maximum Wind Velocity | 51.5m/s (100kt) | |
| Transmitting Frequency | 9410 ±30MHz | |
| Peak-to-peak Power | 4kW | |
| Transmitting Tube | Magnetron [MSF1421B] | |
| TX Pulse width (1st) / (TX Pulse width, Frequency Deviation Width (2nd)) / Repetition Frequency (Observation Range) | SP1: 0.08μs/2250Hz (0.125NM, 0.25NM, 0.5NM, 0.75NM, 1NM, 1.5NM, 2NM, 3NM, 4NM) MP1: 0.25μs/1700Hz (0.75NM, 1NM, 1.5NM, 2NM, 3NM, 4NM, 6NM, 8NM, 12NM, 16NM) MP2: 0.5μs/1200Hz (1.5NM, 2NM, 3NM, 4NM, 6NM, 8NM, 12NM, 16NM) LP1: 1.0μs/650Hz (6NM, 8NM, 12NM, 16NM, 24NM, 32NM, 48NM, 96NM) | |
| Modulator | Solid State Modulator Circuit | |
| Duplexer | Circulator + Diode Limiter | |
| Front End Module | MIC | |
| Overall Noise Figure | 6.0dB (typical) | |
| Intermediate Frequency Amplifier | | |
| Intermediate Frequency | 60MHz | |
| Band Width | 20/6/3MHz | |
| Gain | More than 90dB | |
| Amplifying Characteristics | Logarithmic Amplifier | |

18.15NKE-2063A

| GENERAL SPECIFICATION | NKE-2063A |
|--|---|
| Dimension | Height 419.5 × Swing Circle 1220 (mm) |
| Mass | Approx. 21kg |
| Polarization | Horizontal |
| Horizontal beam width | 2° |
| Vertical beam width | 30° |
| Side lobe level | -23dB or less (less than ±10° from the main lobe) -26dB or less (±10° or more from the main lobe) |
| Revolution | Approx. 27rpm |
| Power Supply for Motor | 24VDC |
| Maximum Wind Velocity | 51.5m/s (100kt) |
| Transmitting Frequency | 9410 ±30MHz |
| Peak-to-peak Power | 6 kW |
| Transmitting Tube | Magnetron [MSF1422B] |
| TX Pulse width (1st) / (TX Pulse width, Frequency Deviation Width (2nd)) / Repetition Frequency (Observation Range) | SP1: 0.08μs/2250Hz (0.125NM, 0.25NM, 0.5NM, 0.75NM, 1NM, 1.5NM, 2NM, 3NM, 4NM) MP1: 0.25μs/1700Hz (0.75NM, 1NM, 1.5NM, 2NM, 3NM, 4NM, 6NM, 8NM, 12NM, 16NM) MP2: 0.5μs/1200Hz (1.5NM, 2NM, 3NM, 4NM, 6NM, 8NM, 12NM, 16NM) LP1: 1.0μs/650Hz (6NM, 8NM, 12NM, 16NM, 24NM, 32NM, 48NM, 96NM) |
| Modulator | Solid State Modulator Circuit |
| Duplexer | Circulator + Diode Limiter |
| Front End Module | MIC |
| Overall Noise Figure | 6.0dB (typical) |
| Intermediate Frequency Amplifier | |
| Intermediate Frequency | 60MHz |
| Band Width | 20/6/3MHz |
| Gain | More than 90dB |
| Amplifying Characteristics | Logarithmic Amplifier |

18.16NKE-2103

| GENERAL SPECIFICATION | | NKE-2103-4 |
|--|---|--------------|
| Dimension | Height 458 × Swing Circle 1320 (mm) | |
| Mass | Approx. 34kg | |
| Polarization | Horizontal | |
| Horizontal beam width | 1.9° | |
| Vertical beam width | 20° | |
| Side lobe level | below -26dB (within ±10°) below -30dB (outside ±10°) | |
| Revolution | Approx. 27 rpm | |
| Power Supply for Motor | 24VDC | |
| Maximum Wind Velocity | 51.5m/s (100kt) | |
| Transmitting Frequency | 9410 ±30MHz | |
| Peak-to-peak Power | 10kW | |
| Transmitting Tube | Magnetron [MAF1565N] | |
| TX Pulse width / Repetition Frequency (Observation Range) | SP1: 0.08μs/2250Hz (0.125NM, 0.25NM, 0.5NM, 0.75NM, 1.5NM, 3NM, 6NM, 12NM) MP1: 0.25μs/1700Hz (0.75NM, 1.5NM, 3NM, 6NM, 12NM) MP2: 0.5μs/1200Hz (1.5NM, 3NM, 6NM, 12NM, 24NM) LP1: 0.8μs/750Hz (3NM, 6NM, 12NM, 24NM) LP2: 1.0μs/650Hz (6NM, 12NM, 24NM, 48NM, 96NM) | |
| Modulator | Solid State Modulator Circuit | |
| Duplexer | Circulator + Diode Limiter | |
| Front End Module | Built-in | |
| Overall Noise Figure | 7.5dB (typical) | |
| Performance Monitor | NJU-85 | |
| Tuning | Manual/AUTO | |
| Intermediate Frequency Amplifier | | |
| Intermediate Frequency | 60MHz | |
| Band Width | 20/6/3MHz | |
| Gain | More than 90dB | |
| Amplifying Characteristics | Logarithmic Amplifier | |
| GENERAL SPECIFICATION | | NKE-2103-4HS |
| Dimension | Height 458 × Swing Circle 1320 (mm) | |
| Mass | Approx. 34kg | |
| Polarization | Horizontal | |
| Horizontal beam width | 1.9° | |
| Vertical beam width | 20° | |
| Side lobe level | below -26dB (within ±10°) below -30dB (outside ±10°) | |
| Revolution | Approx. 48 rpm | |
| Power Supply for Motor | 24VDC | |
| Maximum Wind Velocity | 51.5m/s (100kt) | |
| Transmitting Frequency | 9410 ±30MHz | |
| Peak-to-peak Power | 10kW | |
| Transmitting Tube | Magnetron [MAF1565N] | |
| TX Pulse width / Repetition Frequency (Observation Range) | SP1: 0.08μs/2250Hz (0.125NM, 0.25NM, 0.5NM, 0.75NM, 1.5NM, 3NM, 6NM, 12NM) MP1: 0.25μs/1700Hz (0.75NM, 1.5NM, 3NM, 6NM, 12NM) MP2: 0.5μs/1200Hz (1.5NM, 3NM, 6NM, 12NM, 24NM) LP1: 0.8μs/750Hz (3NM, 6NM, 12NM, 24NM) LP2: 1.0μs/650Hz (6NM, 12NM, 24NM, 48NM, 96NM) | |
| Modulator | Solid State Modulator Circuit | |
| Duplexer | Circulator + Diode Limiter | |
| Front End Module | Built-in | |
| Overall Noise Figure | 7.5dB (typical) | |
| Performance Monitor | NJU-85 | |
| Tuning | Manual/AUTO | |
| Intermediate Frequency Amplifier | | |
| Intermediate Frequency | 60MHz | |
| Band Width | 20/6/3MHz | |
| Gain | More than 90dB | |
| Amplifying Characteristics | Logarithmic Amplifier | |

| GENERAL SPECIFICATION | | NKE-2103-6 |
|--|---|--------------|
| Dimension | Height 458 × Swing Circle 1910 (mm) | |
| Mass | Approx. 36kg | |
| Polarization | Horizontal | |
| Horizontal beam width | 1.2° | |
| Vertical beam width | 20° | |
| Side lobe level | below -26dB (within ±10°) below -30dB (outside ±10°) | |
| Revolution | Approx. 27 rpm | |
| Power Supply for Motor | 24VDC | |
| Maximum Wind Velocity | 51.5m/s (100kt) | |
| Transmitting Frequency | 9410 ±30MHz | |
| Peak-to-peak Power | 10kW ±50% | |
| Transmitting Tube | Magnetron [MAF1565N] | |
| TX Pulse width / Repetition Frequency (Observation Range) | SP1: 0.08µs/2250Hz (0.125NM, 0.25NM, 0.5NM, 0.75NM, 1.5NM, 3NM, 6NM, 12NM) MP1: 0.25µs/1700Hz (0.75NM, 1.5NM, 3NM, 6NM, 12NM) MP2: 0.5µs/1200Hz (1.5NM, 3NM, 6NM, 12NM, 24NM) LP1: 0.8µs/750Hz (3NM, 6NM, 12NM, 24NM) LP2: 1.0µs/650Hz (6NM, 12NM, 24NM, 48NM, 96NM) | |
| Modulator | Solid State Modulator Circuit | |
| Duplexer | Circulator + Diode Limiter | |
| Front End Module | Built-in | |
| Overall Noise Figure | 7.5dB (typical) | |
| Performance Monitor | NJU-85 | |
| Tuning | Manual/AUTO | |
| Intermediate Frequency Amplifier | | |
| Intermediate Frequency | 60MHz | |
| Band Width | 20/6/3MHz | |
| Gain | More than 90dB | |
| Amplifying Characteristics | Logarithmic Amplifier | |
| GENERAL SPECIFICATION | | NKE-2103-6HS |
| Dimension | Height 458 × Swing Circle 1910 (mm) | |
| Mass | Approx. 37kg | |
| Polarization | Horizontal | |
| Horizontal beam width | 1.2° | |
| Vertical beam width | 20° | |
| Side lobe level | below -26dB (within ±10°) below -30dB (outside ±10°) | |
| Revolution | Approx. 48 rpm | |
| Power Supply for Motor | 24VDC | |
| Maximum Wind Velocity | 51.5m/s (100kt) | |
| Transmitting Frequency | 9410 ±30MHz | |
| Peak-to-peak Power | 10kW | |
| Transmitting Tube | Magnetron [MAF1565N] | |
| TX Pulse width / Repetition Frequency (Observation Range) | SP1: 0.08µs/2250Hz (0.125NM, 0.25NM, 0.5NM, 0.75NM, 1.5NM, 3NM, 6NM, 12NM) MP1: 0.25µs/1700Hz (0.75NM, 1.5NM, 3NM, 6NM, 12NM) MP2: 0.5µs/1200Hz (1.5NM, 3NM, 6NM, 12NM, 48NM) LP1: 0.8µs/750Hz (3NM, 6NM, 12NM, 24NM) LP2: 1.0µs/650Hz (6NM, 12NM, 24NM, 48NM, 96NM) | |
| Modulator | Solid State Modulator Circuit | |
| Duplexer | Circulator + Diode Limiter | |
| Front End Module | Built-in | |
| Overall Noise Figure | 7.5dB (typical) | |
| Performance Monitor | NJU-85 | |
| Tuning | Manual/AUTO | |
| Intermediate Frequency Amplifier | | |
| Intermediate Frequency | 60MHz | |
| Band Width | 20/6/3MHz | |
| Gain | More than 90dB | |
| Amplifying Characteristics | Logarithmic Amplifier | |

18.17NKE-2255

| GENERAL SPECIFICATION | NKE-2255-9 |
|--|--|
| Dimension | Height 507 × Swing Circle 2810 (mm) |
| Mass | Approx. 58kg |
| Polarization | Horizontal |
| Horizontal beam width | 0.8° |
| Vertical beam width | 20° |
| Side lobe level | below -26dB (within ±10°) below -30dB (outside ±10°) |
| Revolution | Approx. 24 rpm |
| Power Supply for Motor | 24VDC |
| Maximum Wind Velocity | 51.5m/s (100kt) |
| Transmitting Frequency | 9410 ±30MHz |
| Peak-to-peak Power | 25kW ±50% |
| Transmitting Tube | Magnetron [M1568BS] |
| TX Pulse width / Repetition Frequency (Observation Range) | SP1: 0.07μs/2250Hz (0.125NM, 0.25NM, 0.5NM, 0.75NM, 1.5NM, 3NM, 6NM, 12NM) MP1: 0.2μs/2250Hz (0.75NM, 1.5NM, 3NM, 6NM, 12NM) MP2: 0.3μs/1900Hz (1.5NM, 3NM, 6NM, 12NM) MP3: 0.4μs/1400Hz (1.5NM, 3NM, 6NM, 12NM, 24NM) LP1: 0.8μs/750Hz (3NM, 6NM, 12NM, 24NM) LP2: 1.0μs/650Hz (6NM, 12NM, 24NM, 48NM) LP3: 1.2μs/510Hz (96NM) |
| Modulator | Solid State Modulator Circuit |
| Duplexer | Circulator + Diode Limiter |
| Front End Module | Built-in |
| Overall Noise Figure | 7.5dB (typical) |
| Performance Monitor | NJU-97 (Built-In) |
| Tuning | Manual/AUTO |
| Intermediate Frequency Amplifier | |
| Intermediate Frequency | 60MHz |
| Band Width | 25/8/3MHz |
| Gain | More than 90dB |
| Amplifying Characteristics | Logarithmic Amplifier |

| GENERAL SPECIFICATION | | NKE-2255-7 |
|--|--|--------------|
| Dimension | Height 507 × Swing Circle 2240 (mm) | |
| Mass | Approx. 58kg | |
| Polarization | Horizontal | |
| Horizontal beam width | 1.0° | |
| Vertical beam width | 20° | |
| Side lobe level | below -26dB (within ±10°) below -30dB (outside ±10°) | |
| Revolution | Approx. 24 rpm | |
| Power Supply for Motor | 24VDC | |
| Maximum Wind Velocity | 51.5m/s (100kt) | |
| Transmitting Frequency | 9410 ±30MHz | |
| Peak-to-peak Power | 25kW ±50% | |
| Transmitting Tube | Magnetron [M1568BS] | |
| TX Pulse width / Repetition Frequency (Observation Range) | SP1: 0.07µs/2250Hz (0.125NM, 0.25NM, 0.5NM, 0.75NM, 1.5NM, 3NM, 6NM, 12NM) MP1: 0.2µs/2250Hz (0.75NM, 1.5NM, 3NM, 6NM, 12NM) MP2: 0.3µs/1900Hz (1.5NM, 3NM, 6NM, 12NM) MP3: 0.4µs/1400Hz (1.5NM, 3NM, 6NM, 12NM, 24NM) LP1: 0.8µs/750Hz (3NM, 6NM, 12NM, 24NM) LP2: 1.0µs/650Hz (6NM, 12NM, 24NM, 48NM) LP3: 1.2µs/510Hz (96NM) | |
| Modulator | Solid State Modulator Circuit | |
| Duplexer | Circulator + Diode Limiter | |
| Front End Module | Built-in | |
| Overall Noise Figure | 7.5dB (typical) | |
| Performance Monitor | NJU-97 (Built-In) | |
| Tuning | Manual/AUTO | |
| Intermediate Frequency Amplifier | | |
| Intermediate Frequency | 60MHz | |
| Band Width | 25/8/3MHz | |
| Gain | More than 90dB | |
| Amplifying Characteristics | Logarithmic Amplifier | |
| GENERAL SPECIFICATION | | NKE-2255-6HS |
| Dimension | Height 507 × Swing Circle 1880 (mm) | |
| Mass | Approx. 53kg | |
| Polarization | Horizontal | |
| Horizontal beam width | 1.2° | |
| Vertical beam width | 20° | |
| Side lobe level | below -26dB (within ±10°) below -30dB (outside ±10°) | |
| Revolution | Approx. 48 rpm | |
| Power Supply for Motor | 24VDC | |
| Maximum Wind Velocity | 51.5m/s (100kt) | |
| Transmitting Frequency | 9410 ±30MHz | |
| Peak-to-peak Power | 25kW ±50% | |
| Transmitting Tube | Magnetron [M1568BS] | |
| TX Pulse width / Repetition Frequency (Observation Range) | SP1: 0.07µs/2250Hz (0.125NM, 0.25NM, 0.5NM, 0.75NM, 1.5NM, 3NM, 6NM, 12NM) MP1: 0.2µs/2250Hz (0.75NM, 1.5NM, 3NM, 6NM, 12NM) MP2: 0.3µs/1900Hz (1.5NM, 3NM, 6NM, 12NM) MP3: 0.4µs/1400Hz (1.5NM, 3NM, 6NM, 12NM, 24NM) LP1: 0.8µs/750Hz (3NM, 6NM, 12NM, 24NM) LP2: 1.0µs/650Hz (6NM, 12NM, 24NM, 48NM) LP3: 1.2µs/510Hz (96NM) | |
| Modulator | Solid State Modulator Circuit | |
| Duplexer | Circulator + Diode Limiter | |
| Front End Module | Built-in | |
| Overall Noise Figure | 7.5dB (typical) | |
| Performance Monitor | NJU-97 (Built-In) | |
| Tuning | Manual/AUTO | |
| Intermediate Frequency Amplifier | | |
| Intermediate Frequency | 60MHz | |
| Band Width | 25/8/3MHz | |
| Gain | More than 90dB | |
| Amplifying Characteristics | Logarithmic Amplifier | |

18.18NKE-1130/A

| GENERAL SPECIFICATION | NKE-1130/A |
|--|--|
| Dimension | Height 791 × Swing Circle 4000 (mm) |
| Mass | Approx. 180kg |
| Polarization | Horizontal |
| Horizontal beam width | 1.9° |
| Vertical beam width | 25° |
| Side lobe level | below -26dB (within ±10°) below -30dB (outside ±10°) |
| Revolution | Approx. 24 rpm |
| Power Supply for Motor | 100 to 115VAC, 50/60Hz 1φ or 220 to 240VAC, 50/60Hz 1φ |
| Maximum Wind Velocity | 51.5m/s (100kt) |
| Transmitting Frequency | 3050 ±20MHz |
| Transmission output | Peak-to-peak value 30kW ±50% |
| Transmitting Tube | Magnetron [M1555] |
| TX Pulse width / Repetition Frequency (Observation Range) | SP1: 0.07μs/2250Hz (0.125NM, 0.25NM, 0.5NM, 0.75NM, 1.5NM) MP1: 0.2μs/2250Hz (0.75NM, 1.5NM, 3NM, 6NM, 12NM) MP2: 0.3μs/1900Hz (1.5NM, 3NM, 6NM, 12NM) MP3: 0.4μs/1400Hz(1.5NM, 3NM, 6NM, 12NM, 24NM) LP1: 0.8μs/750Hz (3NM, 6NM, 12NM, 24NM) LP2: 1.0μs/650Hz (6NM, 12NM, 24NM, 48NM) LP3: 1.2μs/510Hz (96NM) |
| Duplexer | Circulator + Diode Limiter |
| Front End Module | Built-in |
| Overall Noise Figure | 7.5dB (typical) |
| Performance Monitor | NJU-84 |
| Intermediate Frequency Amplifier | |
| Intermediate Frequency | 60MHz |
| Band Width | 25/8/3MHz |
| Gain | More than 90dB |
| Amplifying Characteristics | Logarithmic Amplifier |

18.19NKE-1632/A

| GENERAL SPECIFICATION | NKE-1632/A |
|--|---|
| Dimension | Height 791 × Swing Circle 4000 (mm) |
| Mass | Approx. 160kg |
| Polarization | Horizontal |
| Horizontal beam width | 1.9° |
| Vertical beam width | 25° |
| Side lobe level | below -26dB (within ±10°) below -30dB (outside ±10°) |
| Revolution | Approx. 24 rpm |
| Power Supply for Motor | 100 to 115VAC, 50/60Hz 1φ or 220 to 240VAC, 50/60Hz 1φ |
| Maximum Wind Velocity | 51.5m/s (100kt) |
| Transmitting Frequency | PON (3035MHz), QON (3065 ±4MHz) or (3060 ±4MHz) |
| Transmission output | Peak-to-peak value 250W ±50% (Average value 5.8W or lower) |
| Transmitting Tube | Solid State Device |
| TX Pulse width (1st) / (TX Pulse width, Frequency Deviation Width (2nd)) / Repetition Frequency (Observation Range) | SP1: 0.07μs/(4.6μs, 8MHz)/1860Hz or 2280Hz (0.125NM, 0.25NM, 0.5NM, 0.75NM, 1.5NM, 3NM) MP1: 0.14μs/(9.1μs, 8MHz)/1860Hz or 2280Hz (0.75NM, 1.5NM, 3NM, 6NM) MP2: 0.29μs/(9.1μs, 8MHz)/1860Hz or 2280Hz (1.5NM, 3NM, 6NM, 12NM) LP1: 0.57μs/(9.1μs, 8MHz)/1280Hz (3NM, 6NM, 12NM, 24NM) LP2: 1.14μs/(18.3μs, 8MHz)/640Hz (3NM, 6NM, 12NM, 24NM, 48NM, 96NM) |
| Duplexer | Circulator + Diode Limiter |
| Front End Module | Built-in |
| Overall Noise Figure | 4.0dB (typical) |
| Performance Monitor | Built-in |
| Intermediate Frequency Amplifier | |
| Intermediate Frequency | 63MHz |
| Band Width | 30MHz |
| Gain | More than 28dB |
| Amplifying Characteristics | Linear Amplifier |

18.20NKE-2632/A

| GENERAL SPECIFICATION | | NKE-2632/A |
|--|--|------------|
| Dimension | Height 720 × Swing Circle 2770 (mm) | |
| Mass | Approx. 85kg | |
| Polarization | Horizontal | |
| Horizontal beam width | 2.7° | |
| Vertical beam width | 25° | |
| Side lobe level | below -26dB (within ±10°) below -30dB (outside ±10°) | |
| Revolution | Approx. 24 rpm | |
| Power Supply for Motor | 100 to 115VAC, 50/60Hz 1φ or 220 to 240VAC, 50/60Hz 1φ | |
| Maximum Wind Velocity | 51.5m/s (100kt) | |
| Transmitting Frequency | P0N (3035MHz), Q0N (3065 ±4MHz) or (3060 ±4MHz) | |
| Transmission output | Peak-to-peak value 250W ±50% (Average value 5.8W or lower) | |
| Transmitting Tube | Solid State Device | |
| TX Pulse width (1st) / (TX Pulse width, Frequency Deviation Width (2nd)) / Repetition Frequency (Observation Range) | SP1: 0.07μs/ (4.6μs, 8MHz)/1860Hz or 2280Hz (0.125NM, 0.25NM, 0.5NM, 0.75NM, 1.5NM, 3NM) MP1: 0.14μs/ (9.1μs, 8MHz)/1860Hz or 2280Hz (0.75NM, 1.5NM, 3NM, 6NM) MP2: 0.29μs/ (9.1μs, 8MHz)/1860Hz or 2280Hz (1.5NM, 3NM, 6NM, 12NM) LP1: 0.57μs/ (9.1μs, 8MHz)/1280Hz (3NM, 6NM, 12NM, 24NM) LP2: 1.14μs/ (18.3μs, 8MHz)/640Hz (3NM, 6NM, 12NM, 24NM, 48NM, 96NM) | |
| Duplexer | Circulator + Diode Limiter | |
| Front End Module | Built-in | |
| Overall Noise Figure | 4.0dB (typical) | |
| Performance Monitor | Built-in | |
| Intermediate Frequency Amplifier | | |
| Intermediate Frequency | 63MHz | |
| Band Width | 30MHz | |
| Gain | More than 28dB | |
| Amplifying Characteristics | Linear Amplifier | |
| GENERAL SPECIFICATION | | NKE-2632-H |
| Dimension | Height 720 × Swing Circle 2770 (mm) | |
| Mass | Approx. 90kg | |
| Polarization | Horizontal | |
| Horizontal beam width: | 2.7° | |
| Vertical beam width: | 25° | |
| Side lobe level: | below -26dB (within ±10°) below -30dB (outside ±10°) | |
| Revolution | Approx. 48 rpm | |
| Power Supply for Motor | AC100 to 115V, 50/60Hz, 1φ or AC220 to 240V, 50/60Hz, 1φ | |
| Maximum Wind Velocity | 51.5m/s (100kt) | |
| Transmitting Frequency | P0N (3035MHz), Q0N (3065 ±4MHz) or (3060 ±4MHz) | |
| Transmission output | Peak-to-peak value 250W ±50% (Average value 5.8W or lower) | |
| Transmitting Tube | Solid State Device | |
| TX Pulse width (1st) / (TX Pulse width, Frequency Deviation Width (2nd)) / Repetition Frequency (Observation Range) | SP1: 0.07μs/ (4.6μs, 8MHz)/1860Hz or 2280Hz (0.125NM, 0.25NM, 0.5NM, 0.75NM, 1.5NM, 3NM) MP1: 0.14μs/ (9.1μs, 8MHz)/1860Hz or 2280Hz (0.75NM, 1.5NM, 3NM, 6NM) MP2: 0.29μs/ (9.1μs, 8MHz)/1860Hz or 2280Hz (1.5NM, 3NM, 6NM, 12NM) LP1: 0.57μs/ (9.1μs, 8MHz)/1280Hz (3NM, 6NM, 12NM, 24NM) LP2: 1.14μs/ (18.3μs, 8MHz)/640Hz (6NM, 12NM, 24NM, 48NM, 96NM) | |
| Duplexer | Circulator + Diode Limiter | |
| Front End Module | Built-in | |
| Overall Noise Figure | 4.0dB (typical) | |
| Performance Monitor | Built-in | |
| Intermediate Frequency Amplifier | | |
| Intermediate Frequency | 63MHz | |
| Band Width | 30MHz | |
| Gain | More than 28dB | |
| Amplifying Characteristics | Linear Amplifier | |

18.21 NJU-84

| GENERAL SPECIFICATION | | NJU-84 |
|-----------------------|--|--------|
| Dimension | Width 130 × Depth 180 × Height 70 (mm) | |
| Mass | 0.7kg | |
| Operating Frequency | 3050 ±30MHz | |

18.22 NJU-85

| GENERAL SPECIFICATION | | NJU-85 |
|-----------------------|--|--------|
| Dimension | Width 130 × Depth 149 × Height 70 (mm) | |
| Mass | 0.7kg | |
| Operating Frequency | 9410 ±30MHz | |

18.23 NJU-97

| GENERAL SPECIFICATION | | NJU-97 |
|-----------------------|---------------------------------------|--------|
| Dimension | Width 66 × Depth 119 × Height 13 (mm) | |
| Mass | 0.22kg | |
| Operating Frequency | 9410 ±30MHz | |

18.24 Display Unit

<RADAR function>

| FUNCTIONAL SPECIFICATION | |
|-------------------------------------|---|
| View | |
| Range Scale | 0.125, 0.25, 0.5, 0.75, 1.5, 3, 6, 12, 24, 48, 96NM |
| Motion mode | TM (True Motion *except 96NM range) display/(RM (Relative Motion) display |
| Bearing display mode | Relative motion mode: North UP/Course UP/Head UP True motion mode: North UP/Course UP |
| Constaview | Yes |
| Off Centre | Within 75% of Radius |
| Tuning Indication | Bar graph |
| Trails Indication | Off/0.25/0.5/1/3/6/10/15/30/60min |
| Own ship track | Yes |
| 2nd PPI | Yes (*only 26-inch monitor) |
| Navigational tools | |
| Bearing Scale | 360° in 1° step |
| Heading Line Indication | Yes |
| Range Marker | 0.025, 0.05, 0.1, 0.25, 0.5, 1, 2, 4, 8, 16 NM |
| Range Accuracy | Less than 1% of the Range Scale in use, or 30m whichever is larger. |
| Variable Range Marker (VRM) | 2 |
| VRM range display | 0.000 to 96.0NM, 4-digit display |
| Electronic Bearing Line (EBL) | 2 (centre/independent) |
| EBL bearing display | 0.000 to 359.9°, 4-digit display |
| Trackball Cursor | Yes (range, true/relative bearing, TTG, ETA display) |
| Parallel Index Line (PI) | Yes (All/Individual/Track/Equiangular) |
| Signal Process | |
| Anti Sea Clutter (SEA) | Manual/AUTO |
| Anti Rain Clutter (RAIN) | Manual/AUTO |
| Interference Rejection (IR) | Yes |
| Video Process | Yes |
| TT/AIS | |
| Acquisition/Activation zone (AZ) | 2 (Sector) |
| TT indication | 30 #Option: up to 100*1 |
| AIS indication | 180 #Option: up to 1000*1 |
| Chart Functions (option) | |
| Chart display function | C-MAP MAX newpec |
| Sailing monitoring functions | |
| Own ship | Monitoring by positioning equipment Time stamp display Dragging anchor monitoring Own ship track display |
| Route monitoring | Cross track monitoring Next WP arrival monitoring Off-course monitoring |
| User Map | |
| Number of points displayed | 2,000 points/ 10 colours (marks, lines) #Plotter option: up to 200,000 / 10 colours. |
| Variety of mark | 29 |
| Variety of line | Solid line, Dotted line, Broken line |
| Export | Possible (USB memory) |
| Other functions | |
| Self-diagnosis function | Available |
| Remote maintenance function | Available |
| Plotter mode | Available(Plotter option is required) |

*1: When used as CAT1 / 1H, TT / AIS option are required.

Receivable signals (i)

| | |
|-------------------------------------|----------------------------------|
| Ship heading | THS > HDT (over 40Hz) |
| Course | GGA > RMC > RMA > GNS > GLL |
| Geodetic positioning system | DTM |
| Date information | ZDA |
| COG/SOG | RMC > RMA > VTG |
| Ship speed through water | VBW > VHW |
| Turning speed | ROT |
| Water depth | DPT > DBS > DBK > DBT |
| Wind direction/wind speed | MWV > MWD |
| Air temperature | MTA > MDA |
| Water temperature | MTW > MDA |
| Atmospheric pressure | MMB > MDA |
| Humidity | MHU > MDA |
| AIS | VDM, VDO |
| Alert | ACK, ALR, ACN, ALF |
| NAVTEX | NRX or JRC format |
| Azimuth/distance to the destination | RMB > BWC > BWR (Plotter option) |
| Water current | CUR |

Transmittable signals

| | |
|-------------------------------------|---|
| RADAR system data | RSD*1 |
| Own ship data | OSD*2 |
| Watch Timer Reset | EVE*3 |
| TT data | TTM, TLL, TTD, TLB |
| AIS target data | TTM, TLL, TTD |
| AIS remote control data | VSD, AIR, AIQ, ABM, BBM |
| Remote maintenance data | JRC format |
| Alert | ACK, ALR, ACN, ALC, ALF, ARC, HBT |
| NAVTEX | NRM |
| Azimuth/distance to the destination | BWC, RMB |
| Navigation Data | DBK, DPT, DTM, GGA, GLL, HDG, HDT, MDA, MWV, NSR, POS, RMC, ROT, RSA, THS, VBW, VDR, VTG, VWR, VWT, XDR, ZDA, BWC, RTE, WPL, APB, BOD, OSD, RSD, XTE, ZTG |

Visual range

Visual range 1.0m from the centre of display

- i. The Speed measuring accuracy of speed sensor shall confirm to IMO Resolution MSC.96(72).
The measuring accuracy of GPS shall confirm to IMO Resolution MSC.112(73).

*1 The output range unit is fixed to Nautical Mile.

*2 The output speed unit is fixed to Knot.

*3 When the value exceeds the set value, a message is output indicating a non-operation state. The value is set at installation.

18.25 Target Tracking

| FUNCTIONAL SPECIFICATION | |
|---------------------------------|--|
| Acquisition | |
| Acquisition Mode | Manual/AUTO (AUTO mode uses AUTO-acquisition Zone) |
| Manual Cancellation | Any one Target or All targets at once |
| Acquisition Range | 0.1NM to 32NM (Available in all range scale) |
| Tracking | |
| Number of Target | 30 targets (Option: up to 100 targets) |
| Tracking Range | 0.1NM to 32NM (Available in all range scale) |
| View | |
| Motion mode | TM (True Motion) / RM (Relative Motion) |
| Azimuth mode | North UP, Head UP, Course UP |
| Vector mode | True / Relative Display |
| Vector Length | Variable, 1 to 120 min. (1min. step) |
| Past Position | Number of Dots --- 10 points Display Interval Time --- 0.5 / 1 / 2 / 4 min Display range: 0.1NM, 0.2NM, 0.5NM, and 1NM |
| Time to Display Vector | within 1 minute |
| Time to Stabilise Vector | within 3 minutes |
| Alarm | |
| AUTO-acquisition Zone (AZ) | 2 (sector) |
| Setting range | 1NM to 32NM |
| Alarm Indication | Symbol on Display, Visible/Audible Alarm |
| Safe Limits (CPA/TCPA) | |
| CPA LIMIT | 0.1 to 9.9NM |
| TCPA LIMIT | 1 to 99 minutes |
| Conditions | |
| Safe Target | CPA > CPA Limit 0 > TCPA TCPA > TCPA Limit |
| Dangerous Target | CPA ≤ CPA Limit 0 ≤ TCPA ≤ TCPA Limit |
| Lost Target | Symbol on Display, Visible/Audible Alarm |
| Alert Indication | |
| Safe Target | Colour: White, Alert: OFF, Buzzer: OFF |
| Dangerous Target | Colour: Red, Alert: ON, Buzzer: ON |
| Data Indication | |
| Target Data | Simultaneous display for 10 targets (26-inch screen)/4 targets (19-inch screen) True Bearing, Range, True Course, True Speed, CPA, TCPA, BCR, BCT |
| Own Ship's Data | Course and Speed |
| Trial Manoeuvre | |
| Manual Setting | |
| Trial Course | 0° to 359.9° |
| Trial Speed | 0 to 100 kn |
| Another ship track | 100 targets. 4000 points per one target can be displayed. (Own ship track and marks are another.) Display color : 10 colors (The display color of each target can be set.) (The display color of all targets can be set by the batch. In this case, the display color is one color.) Interval of save : 3/5/10/30 sec, 1/3/5/10/30/60 min, 0.1/0.2/0.3/0.5/1/3/5/10 NM Possible to storage in memory card (Option). |
| Accuracy of Display | Complied with IMO Requirements |
| System Failure | Visible / Audible Alarm |
| Speed Input | Manual / AUTO (LOG) |

18.26 AIS

| FUNCTIONAL SPECIFICATION | |
|---|--|
| Activation | |
| Acquisition Mode | Manual/AUTO (AUTO mode uses AUTO-acquisition Zone) |
| Manual Cancellation | Any one Target |
| Presentation | |
| Number of Targets (Sleeping and activated) | 180 [171] targets (Option: 1000 [950])*1 |
| No. of targets processed | 1024 targets |
| Past Position | True / Relative Display Number of Dots --- 10 points Display Interval Time --- 0.5 / 1 / 2 / 4 min Display Interval Distance --- 0.1 / 0.2 / 0.5 / 1 NM |
| Message | Broadcast Message, Addressed Message |
| Motion mode | TM (True Motion) / RM (Relative Motion) |
| Azimuth mode | North UP, Head UP, Course UP |
| Vector mode | True / Relative Display |
| Vector Length | Variable, 1 to 120 min. (1min. step) |
| Alarm | |
| AUTO-acquisition Zone (AZ) | 2 (sector) |
| Setting range | 1NM to 32NM |
| Alarm Indication | Symbol on Display, Visible/Audible Alarm |
| Safe Limits (CPA/TCPA) | |
| CPA LIMIT | 0.1 to 9.9NM |
| TCPA LIMIT | 1 to 99 minutes |
| Conditions | |
| Safe Target | CPA > CPA Limit 0 > TCPA TCPA > TCPA Limit |
| Dangerous Target | CPA ≤ CPA Limit 0 ≤ TCPA ≤ TCPA Limit |
| Lost Target | Symbol on Display, Visible/Audible Alarm |
| Alert Indication | |
| Safe Target | Colour: White, Alert: OFF, Buzzer: OFF |
| Dangerous Target | Colour: Red, Alert: ON, Buzzer: ON |
| Data Indication | |
| Target Data | |
| Simple Display | Simultaneous and Continuous Display for 4 to targets (simple display) and 2 to targets (details display) Ship's name, Call sign, MMSI, Course, Speed, CPA and TCPA |
| Details Display | Ship's name, Call sign, MMSI, Course, Speed, CPA, TCPA, Bearing, Range, Ship's Heading Bearing, Rate of turn, Latitude, Longitude, Destination and Navigation Status |
| Own Ship's Data | The ship's name, Call sign, MMSI, Course, Speed, Ship's heading bearing, Rate of turn, Latitude, Longitude, Destination, and Navigation status of own ship (details display) |
| Trial Manoeuvre | |
| Manual Setting | |
| Trial Course | 0° to 359.9° |
| Trial Speed | 0 to 100 kn |
| Another ship track | 100 targets. 4000 points per one target can be displayed. (Own ship track and marks are another.) Display color : 10 colors (The display color of each target can be set.) (The display color of all targets can be set by the batch. In this case, the display color is one color.) Interval of save : 3/5/10/30 sec, 1/3/5/10/30/60 min, 0.1/0.2/0.3/0.5/1/3/5/10 NM Possible to storage in memory card (Option). |
| Accuracy of Display | Complied with IMO Requirements |
| System Failure | Visible / Audible Alarm |
| Speed Input | AUTO (LOG) |

*1 The value in [] indicates the 95% of the number of maximum targets.

18.27 Process Unit

| GENERAL SPECIFICATION | NDC-1678/A: Process Unit |
|---|---|
| CPU | NDC-1678 : Intel Core i5 4400E 2.7GHz NDC-1678A : Intel Core i3 6100E 2.7GHz |
| Main Memory | NDC-1678 : 4GB (DDR3L) NDC-1678A : 4GB (DDR4) |
| JRC ASIC | Yes |
| Mechanical | |
| Dimension | Width 340 × Depth 330 × Height 171 (mm) |
| Mass | 7.1kg |
| FAN | 1 |
| Environment | |
| Operational Temperature | -15°C to +55°C |
| Operational Humidity | 40°C RH 93% |
| Vibration | Sweep 2Hz to 13.2Hz at ± 1mm, 13.2Hz to 100Hz at 7m/s ² and for 2h on each resonance, otherwise 2h at 30Hz in all three axes |
| EMC | IEC60945-Ed4.0 |
| Ingress Protection Rating | IP22 (need to a partition plate) |
| Interfaces | |
| DVI-D | 2 |
| VGA | 1 (Slave output as DVI-D) |
| IEC61162-1 | 4 input |
| IEC61162-2 | 2 input + 1 input (for Gyro) |
| IEC61162-450 | 2 (IEEE802.3u/IEEE802.3ab compliance (100BASE-TX/100BASE-T)) |
| GPS | 1 (for JRC equipment) |
| GYRO COMPASS | 1 (for JRC equipment) |
| Dry Contact Output (N.C/N.O selectable) | 2 (Power Fail and Watch Timer Reset, 32V, 0.8A sink MAX) |
| Contact Input | 3 (5V, 50mA source MAX) |
| Operation Unit | 2 |
| USB I/F | 1 |
| RADAR I/F | 1 input for scanner unit, 1 input for other equipment |
| DC Input | |
| Voltage | 24VDC |
| Voltage Range | 21.6 to 31.2VDC |
| Overvoltage Protection | 42V |
| Input Current | MAX 16A |
| Over current Protection | Yes |
| Rated Output | |
| Output (for MNU) | 24.0V ±0.48V 6A |
| Output (for TXRX) | 24.0V ±0.48V 6A |

18.28 Standard Operation Unit

| GENERAL SPECIFICATION | NCE-5794: Standard Operation Unit |
|---------------------------|---|
| Pointing Device | 2inch Trackball |
| Click Button | 2-buttons (Left and Right) |
| USB I/F | 1 |
| Chart Card Slot | 1 |
| Speaker | 1 |
| Keys | POWER, OFF, TX/STBY, AZ, OFFCENT, DAYNIGHT, MAP, PI, MOB, PANEL, USER1, USER2, SILENCE, ALERT, ACK, RANGE |
| Knob | MULTI, EBL, VRM, SEA, RAIN, GAIN/PL |
| Cable Length | Up to 5m (Up to 50m when using the extended option) |
| Mechanical | |
| Dimension | Width 350 × Depth 120 × Height 70 (mm) |
| Mass | 1.7kg |
| Environment | |
| Operational Temperature | -15°C to +55°C |
| Operational Humidity | 40°C RH 93% |
| Vibration | Sweep 2Hz to 13.2Hz at ± 1mm, 13.2Hz to 100Hz at 7m/s ² and for 2h on each resonance, otherwise 2h at 30Hz in all three axes |
| EMC | IEC60945-Ed4.0 |
| Ingress Protection Rating | Front : IP22 |
| Visual range | |
| Visual range | 0.6m from the centre of operation unit |

18.29 Trackball Operation Unit

| GENERAL SPECIFICATION | NCE-5605: Trackball Operation Unit |
|---------------------------|--|
| Pointing Device | 2inch Trackball |
| Click Button | 2-buttons (Left and Right) |
| USB I/F | 1 |
| Speaker | 1 |
| Vibration | 1 |
| Keys | SILENCE/ALERT ACK/ZOOM IN/ZOOM OUT |
| Knob | Multi Function Knob |
| Cable Length | Up to 5m (Up to 30m when using the extended option) |
| Mechanical | |
| Dimension | Width 130 × Depth 210 × Height 177 (mm) |
| Mass | 1.3kg |
| Environment | |
| Operational Temperature | -15°C to +55°C |
| Operational Humidity | 40°C RH 93% |
| Vibration | Sweep 2Hz to 13.2Hz at ± 1mm, 13.2Hz to 100Hz at 7m/s ² and for 2h on each resonance, otherwise 2h at 30Hz in all three axes |
| EMC | IEC60945-Ed4.0 |
| Ingress Protection Rating | Front : IP22 |
| Visual range | |
| Visual range | 0.6m from the centre of operation unit |

18.30 Keyboard Operation Unit

| GENERAL SPECIFICATION | NCE-5625: Keyboard Operation Unit |
|---------------------------|--|
| PC Keyboard | |
| Layout | QWERTY |
| Pitch | 15mm |
| Stroke | 2mm |
| Dedicated Keys | |
| Keys | HOME, TX/STBY, PI, DISP OFF, AZ, PANEL, DAY/NIGHT, MOB, USER1, USER2 |
| Knobs | EBL, VRM, SEA, RAIN, GAIN |
| Mechanical | |
| Dimension | Width 270 × Depth 210 × Height 30 (mm) |
| Mass | 0.8kg |
| Environment | |
| Operational Temperature | -15°C to +55°C |
| Operational Humidity | 40°C RH 93% |
| Vibration | Sweep 2Hz to 13.2Hz at ± 1mm, 13.2Hz to 100Hz at 7m/s ² and for 2h on each resonance, otherwise 2h at 30Hz in all three axes |
| EMC | IEC60945-Ed4.0 |
| Ingress Protection Rating | Front : IP22 |
| Visual range | |
| Visual range | 0.6m from the centre of operation unit |

18.31 19inch Display

| GENERAL SPECIFICATION | | NWZ-214 (-AC): Display |
|------------------------------------|---|------------------------|
| Screen Size | 19inch | |
| Aspect Ratio | 5:4 | |
| Full Resolution | 1280×1024 | |
| Supported format | 1280×1024, 1280×960, 1024×768, 800×600, 640×480, 720×400 | |
| Dot Pitch | 0.294mm | |
| Viewing Area | 376.32mm × 301.06mm | |
| Display Colours | 16.77 million colours | |
| Contrast Ratio | 2000:1 | |
| Viewing Angles (H / V) | 178° / 178° | |
| Back Light | LED | |
| Brightness | 1000cd/m ² Type | |
| Digital Scanning Frequency (H / V) | Horizon 30kHz to 80kHz Vertical 56Hz to 75Hz | |
| DVI-D input | 1 | |
| VGA input | 1 | |
| VGA output | N/A | |
| USB I/F | N/A | |
| Power | 21.6 to 31.2VDC 85 to 132VAC / 170 to 264VAC 47Hz to 63Hz (Option) | |
| Overvoltage Protection | N/A | |
| DC Reverse Connection Protection | Self Return Type | |
| Cables | Up to 5m | |
| Glass Bonding | Standard | |
| Power Consumption | Less than 60W Less than 66W(AC Option) | |
| Mechanical | | |
| Dimension | Width 429 × Depth 76 × Height 382 (mm) | |
| Mass | 4.6kg 4.9kg (AC option) | |
| Fan | 1 | |
| Glass | Tempered Glass + AR Coating | |
| Environment | | |
| Operational Temperature | -15°C to +55°C | |
| Operational Humidity | 40°C RH 93% | |
| Vibration | Sweep 2Hz to 13.2Hz at ± 1mm, 13.2Hz to 100Hz at 7m/s ² and for 2h on each resonance, otherwise 2h at 30Hz in all three axes | |
| EMC | IEC60945-Ed4.0 | |
| Ingress Protection Rating | Front:IP65 Back:IP22 | |
| Visual range | | |
| Visual range | 1.0m from the centre of display | |
| View | | |
| PPI Diameter | 272mm | |

18.32 26inch Display

| GENERAL SPECIFICATION | NWZ-208: Display |
|------------------------------------|--|
| Screen Size | 26inch |
| Aspect Ratio | 16:10 |
| Full Resolution | 1920×1200RB |
| Supported format | 1920×1200RB, 1680×1050, 1680×1050RB, 1600×1200, 1600×1200RB, 1280×1024, 1024×768, 800×600, 640×480 |
| Dot Pitch | 0.2865mm |
| Viewing Area | 550.08mm × 343.8 mm |
| Display Colours | 16.77 million colours |
| Contrast Ratio | 1500:1 |
| Viewing Angles (H / V) | 176° / 176° |
| Back Light | LED |
| Brightness | 400cd/m ² Type |
| Digital Scanning Frequency (H / V) | Horizontal 30kHz to 75kHz Vertical 56Hz to 75Hz |
| DVI-D input | 1 |
| VGA input | 1 |
| VGA output | 1 |
| USB I/F | 1 |
| Power | 21.6 to 31.2VDC 85 to 265VAC 50/60Hz |
| Overvoltage Protection | N/A |
| DC Reverse Connection Protection | Self-Return Type |
| Cables | Up to 5m |
| Glass Bonding | Optional |
| Power Consumption | Less than 108W |
| Mechanical | |
| Dimension | Width 624 × Depth 85 × Height 456 (mm) |
| Mass | 16kg |
| Fan | 2 |
| Glass | Tempered Glass + AR Coating |
| Environment | |
| Operational Temperature | -15°C to +55°C |
| Operational Humidity | 40°C RH 93% |
| Vibration | Sweep 2Hz to 13.2Hz at ± 1mm, 13.2Hz to 100Hz at 7m/s ² and for 2h on each resonance, otherwise 2h at 30Hz in all three axes |
| EMC | IEC60945-Ed4.0 |
| Ingress Protection Rating | Front: IP65 Back: IP22 |
| Visual range | |
| Visual range | 1.0m from the centre of display |
| View | |
| PPI Diameter | 328mm (2nd PPI : 137mm) |

18.33 Sensor LAN Switch Unit

| GENERAL SPECIFICATION | | NQA-2443: Sensor LAN switch unit |
|-----------------------------|---|-----------------------------------|
| Technology | | |
| Standards | IEEE802.3, 802.3u, 802.3x | |
| Processing type | Store and Forward, with IEEE802.3 full duplex, back pressure flow control | |
| Forward and Filtering Rate | 148810 pps | |
| Latency | Less than 5us | |
| Interface | | |
| Number of ports | 16 | |
| RJ45 | 10/100BASE-T(X) AUTO negotiation speed, F/H duplex mode, and AUTO MDI/MDI-X connection | |
| LED | Power, Fault, Speed | |
| Power | | |
| Input Voltage | 12 to 48 VDC | |
| Input Current | 0.34A MAX | |
| Over Current Protection | 1.6A | |
| Reverse Polarity Protection | Yes | |
| Mechanical | | |
| Dimension | Width 75.0 x Depth 105 x Height 179 (mm) | |
| Mass | 1.5kg | |
| Environment | | |
| Operational Temperature | -15°C to +55°C | |
| Operational Humidity | 40°C RH 93% | |
| Vibration | Sweep 2Hz to 13.2Hz at ± 1mm, 13.2Hz to 100Hz at 7m/s ² and for 2h on each resonance, otherwise 2h at 30Hz in all three axes | |
| EMC | IEC60945-Ed4.0 | |
| GENERAL SPECIFICATION | | NQA-2443A: Sensor LAN switch unit |
| Technology | | |
| Standards | IEEE802.3, 802.3u, 802.3x, 802.3ab | |
| Processing type | Store and Forward, with IEEE802.3 full duplex, 14880 pps / port (10Mbps, 64byte pkt, uni-cast) | |
| Maximum throughput | 148810 pps / port (100Mbps, 64byte pkt, uni-cast) | |
| | 1488100 pps / port (1000Mbps, 64byte pkt, uni-cast) *Wire speed : 100% | |
| Interface | | |
| Number of ports | 16 | |
| RJ45 | 10/100/1000BASE-T(X) auto negotiation speed, F/H duplex mode, and auto MDI/MDI-X connection | |
| LED | PWR, UVP/OVP, RVP, LOOP, LINK/ACT | |
| Power | | |
| Input Voltage | 18 to 36 VDC | |
| Maximum Power Consumption | 13.2 W and under | |
| Reverse Polarity Protection | Yes | |
| Mechanical | | |
| Dimension | Width 75.0 x Depth 105 x Height 179 (mm) | |
| Mass | 0.8kg | |
| Environment | | |
| Operational Temperature | -25°C to +70°C | |
| Operational Humidity | 40°C RH 93% | |
| Vibration | Sweep 2 Hz to 13.2 Hz at ± 1 mm, 13.2 Hz to 100 Hz at 7m/s ² and for 2h on each resonance, otherwise 2h at 30 Hz in all three axes | |
| EMC | IEC60945-Ed4.0 | |

18.34 Junction Box

| GENERAL SPECIFICATION | | NQE-1143: Junction Box |
|---|--|--|
| Mechanical | | |
| Dimension | Width 400 × Depth 86 × Height 261.5 (mm) | |
| Mass | 3.8kg | |
| Environment | | |
| Operational Temperature | -15°C to +55°C | |
| Operational Humidity | 40°C RH 93% | |
| Vibration | Sweep 2Hz to 13.2Hz at ± 1mm, 13.2Hz to 100Hz at 7m/s ² and for 2h on each resonance, otherwise 2h at 30Hz in all three axes | |
| EMC | IEC60945-Ed4.0 | |
| Ingress Protection Rating | Front : IP20 | |
| Power | | |
| Power | 21.6 to 31.2 VDC | |
| Input Voltage | 48W MAX | |
| Input Current | 3A×2, 15A×1 Mini Blade Fuse | |
| Over Current Protection | Yes | |
| FUNCTIONAL SPECIFICATION | | CMH-2370: Serial LAN Interface Circuit |
| Interface | | |
| IEC61162-1 | 8 input / 8 output | |
| IEC61162-2 | 2 input / 2 output | |
| IEC61162-450 | 1 (100BASE-TX) | |
| Dry Contact Output (N.C/N.O selectable) | 8 (32V, 0.8A sink MAX) | |
| Dry Contact Input | 8 (5V, 50mA source MAX) | |
| Ingress Protection Rating | Front : IP20 | |

Appendix A Radar Antenna / Display Unit Block Diagrams

A.1 Radar Antenna Block Diagrams

A.1.1 NKE-1130 (110 VAC)

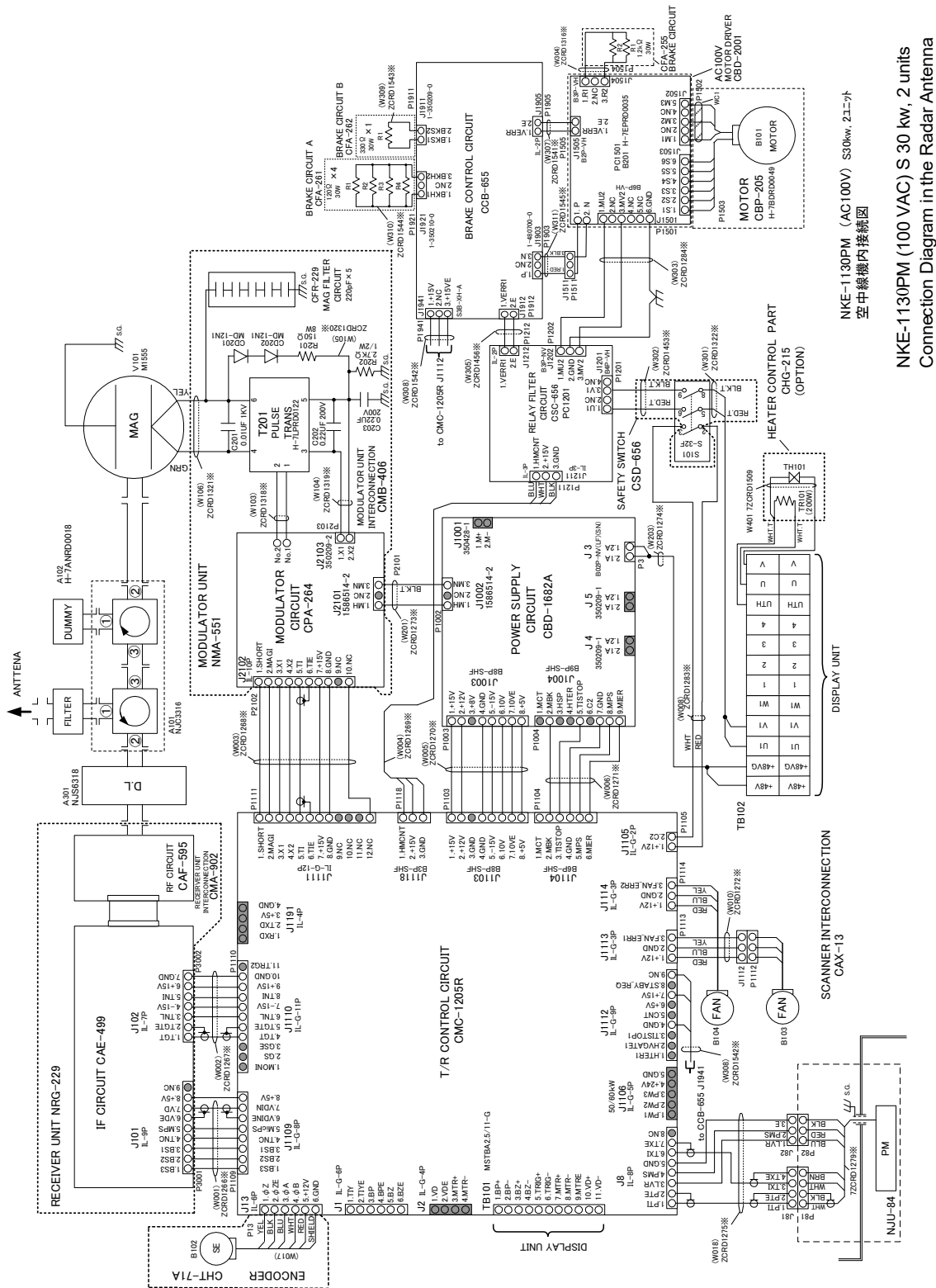

NKE-1130PM (AC100V) S30kw, 21二一
空中線機内接続図

NKE-1130PM (100 VAC) S 30 kw, 2 units
Connection Diagram in the Radar Antenna

A.1.2 NKE-1130 (220 VAC)

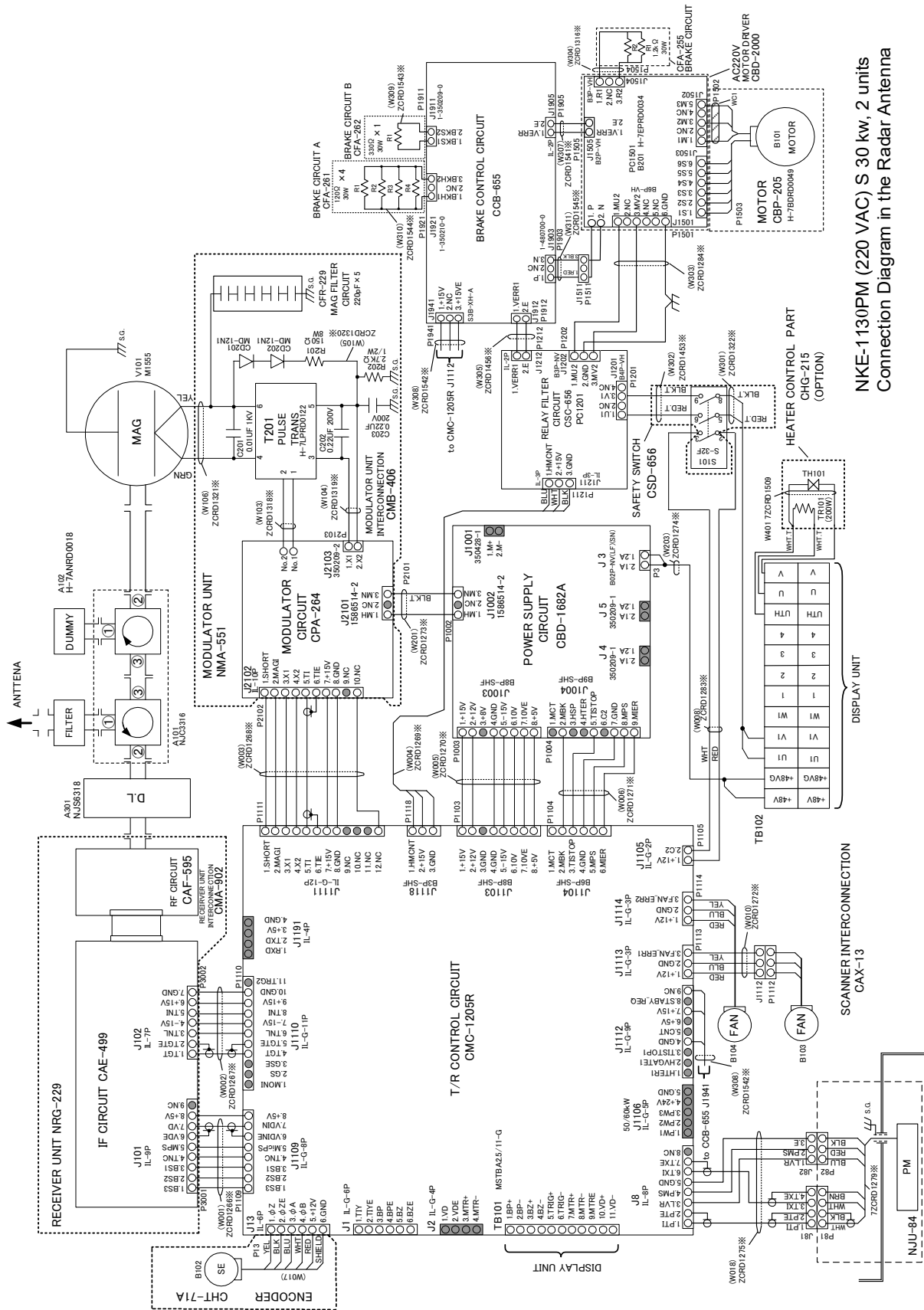

NKE-1130PM (220 VAC) S 30 kw, 2 units
Connection Diagram in the Radar Antenna

A.1.4 NKE-1632

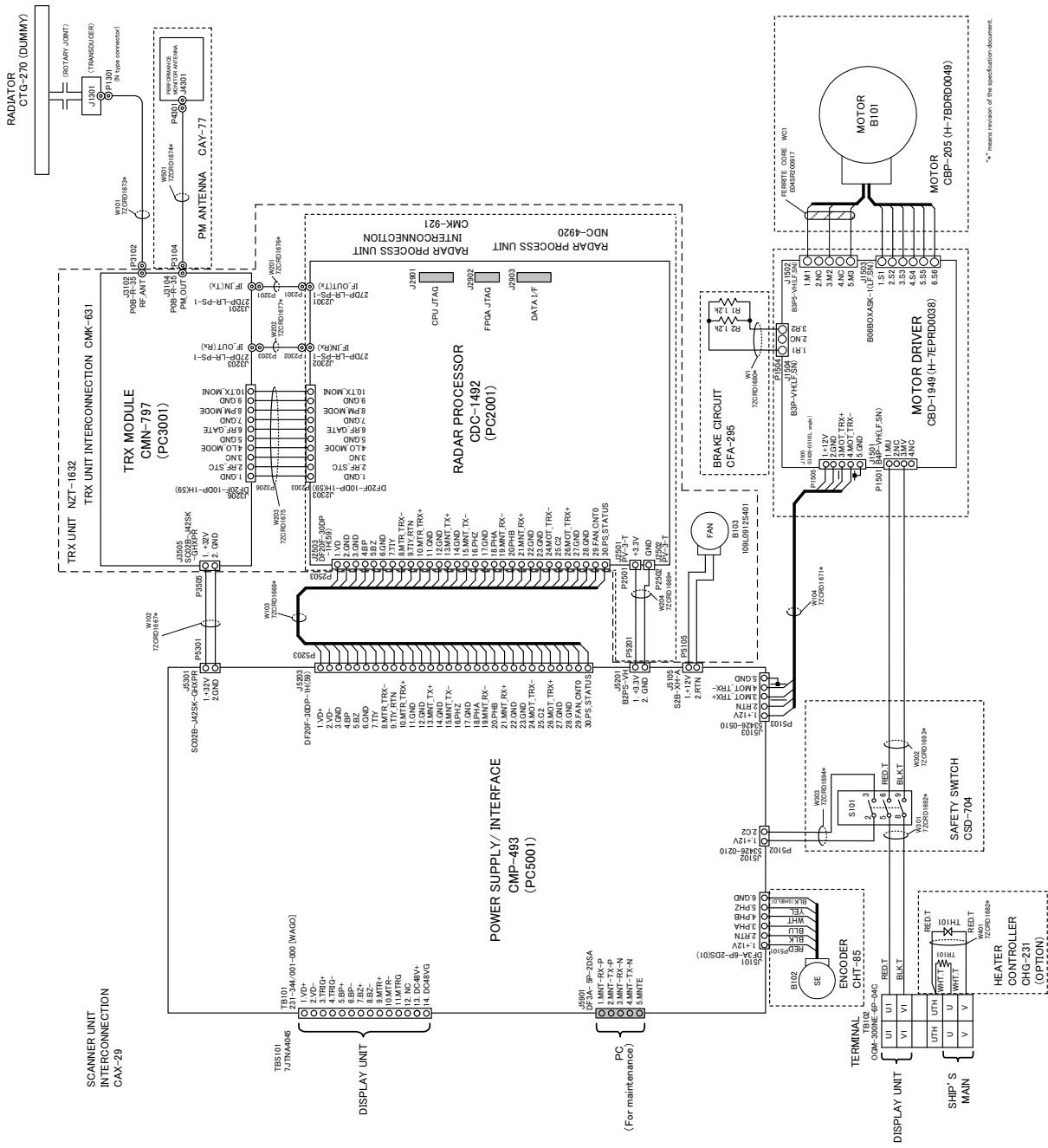

NKE-1632 INTERCONNECTION

A.1.5 NKE-1632A

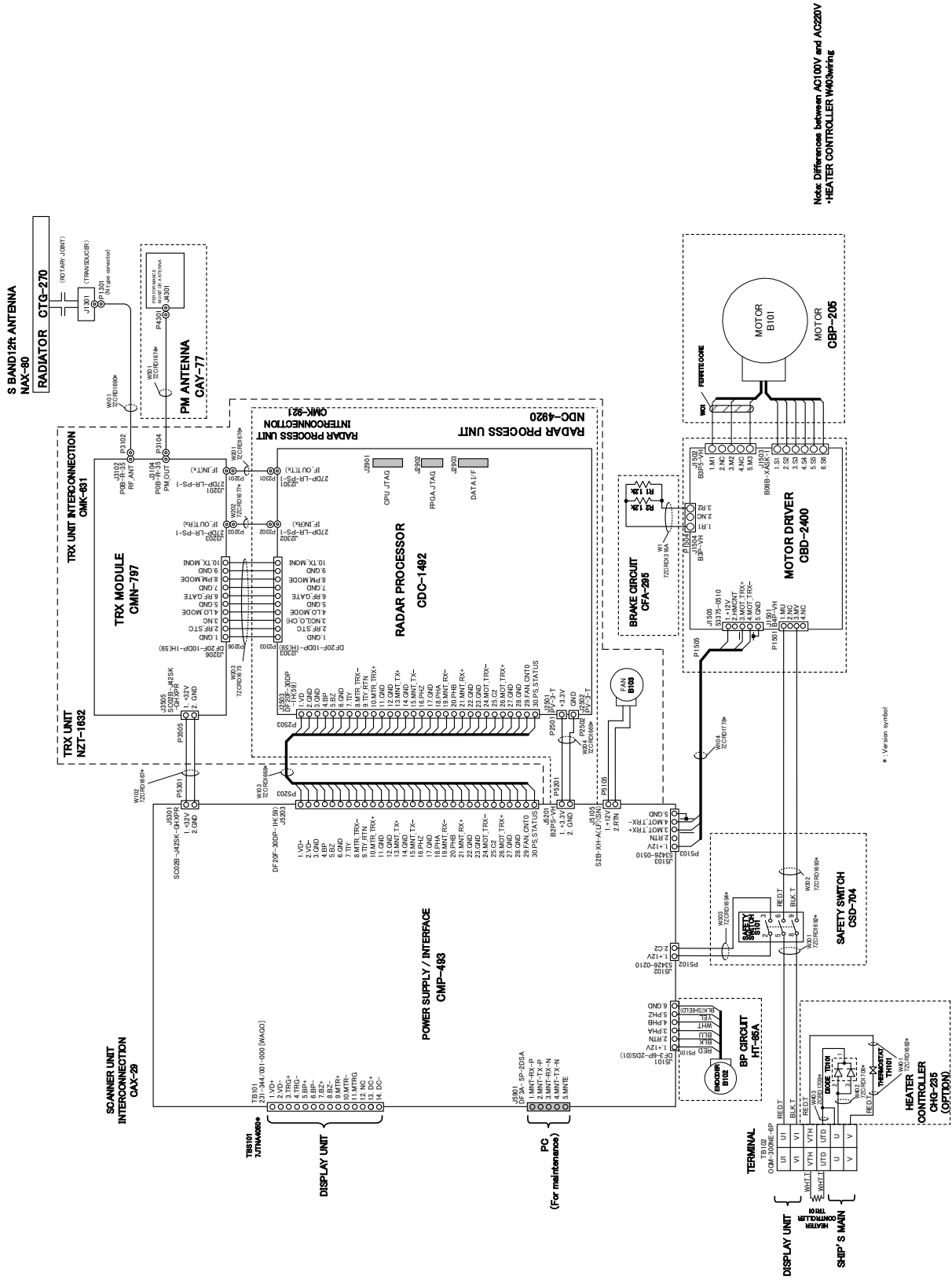

Note: Differences between AC10V and AC20V
-HEATER CONTROLLER W/3SWING

NKE-1632A INTERCONNECTION

A.1.7 NKE-2632A

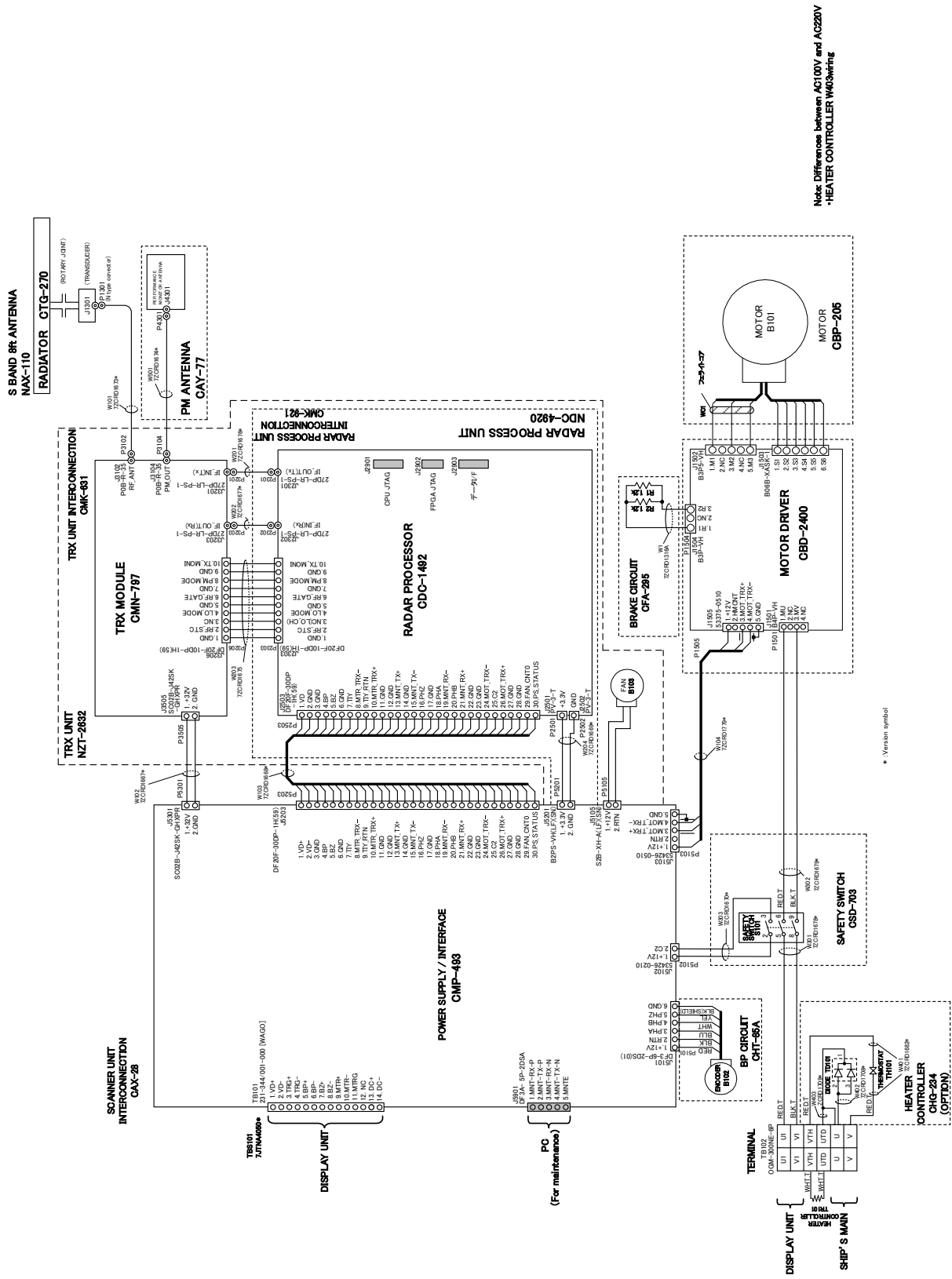

NKE-2632A INTERCONNECTION

A.1.8 NKE-2255-7/9/6HS

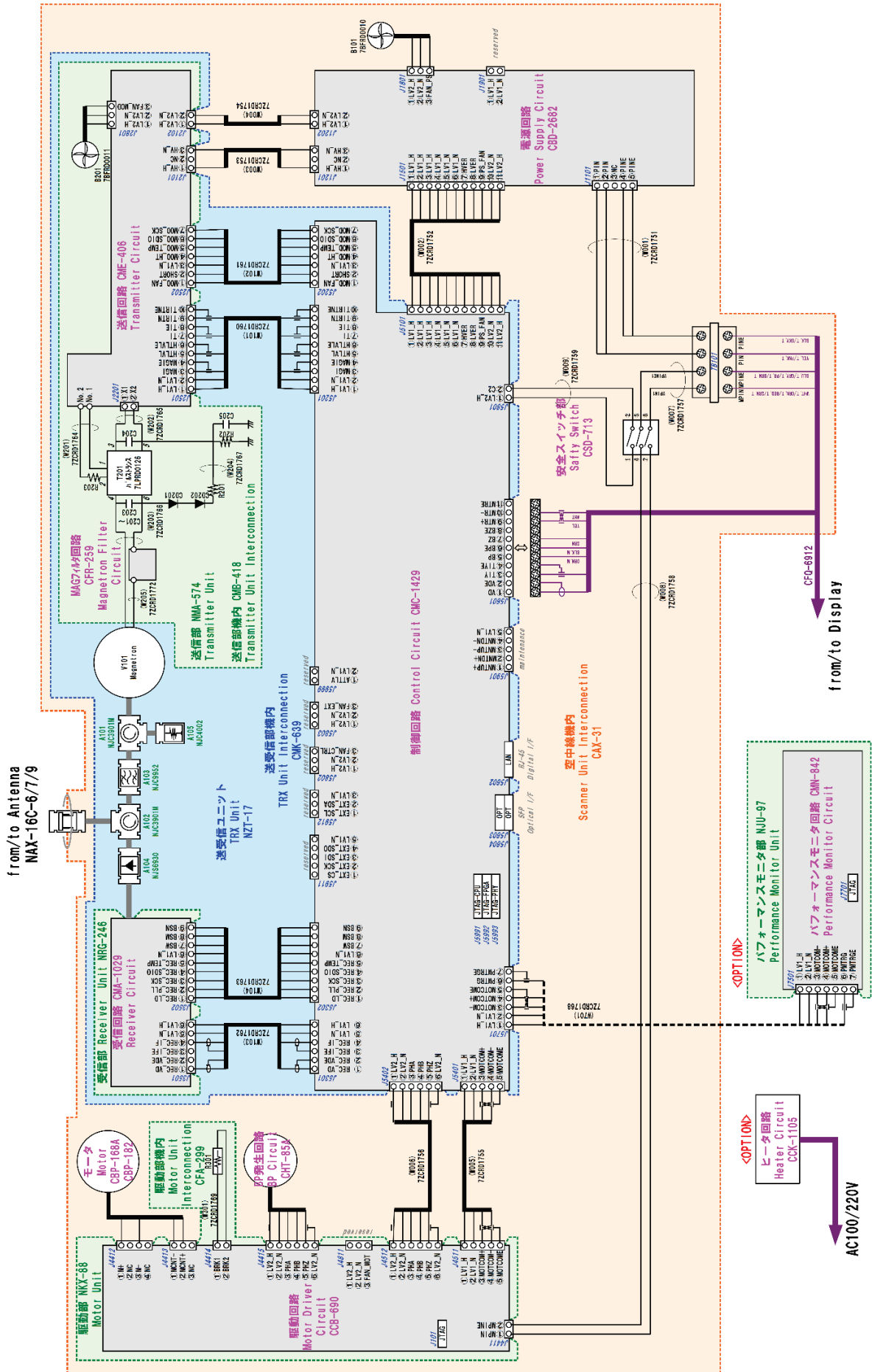

A.1.10 NKE-2063A

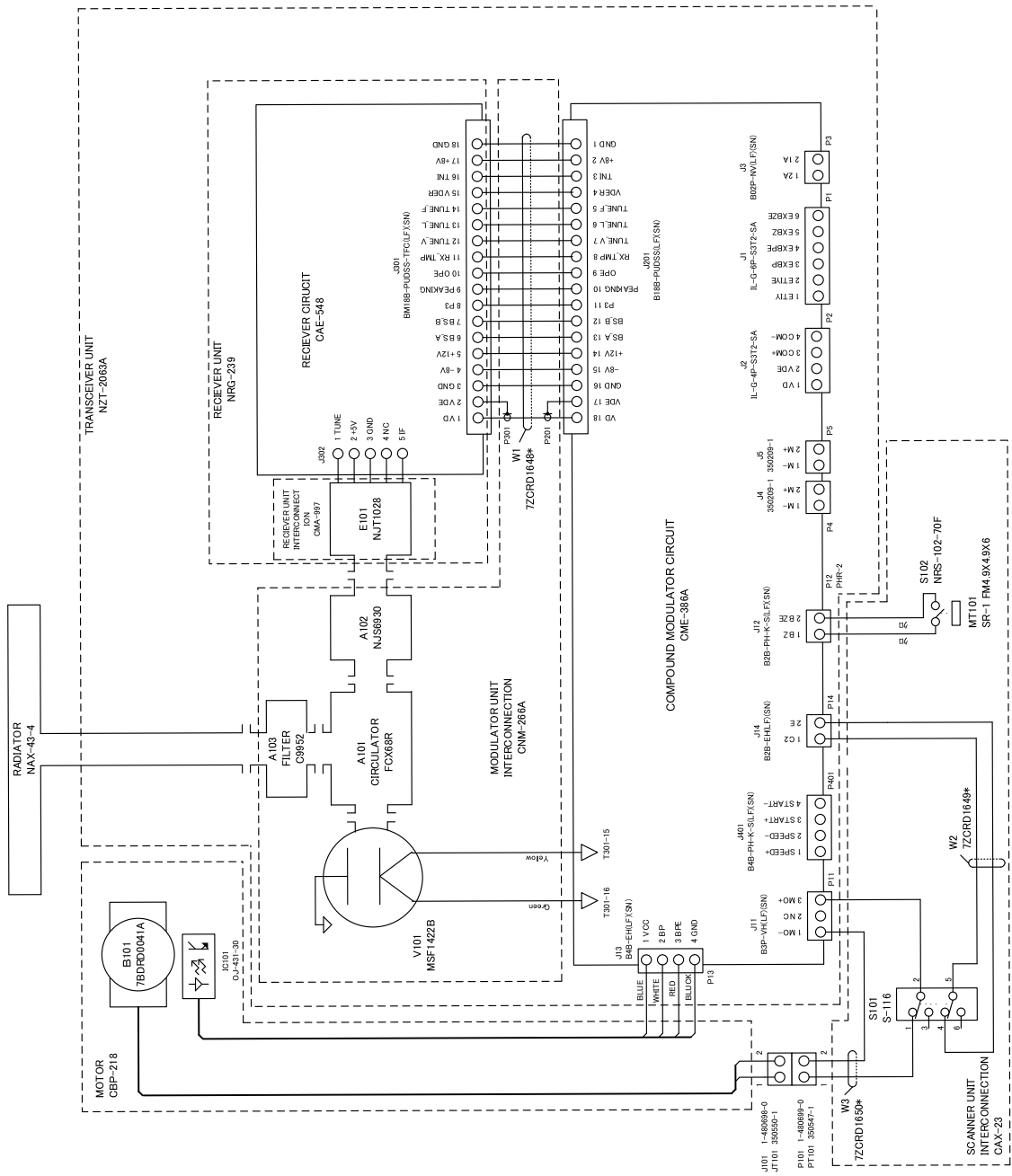

⊕ : Coaxial cable 1.5D ←

* means revision of the specification document. ←

A.1.11 NKE-2043

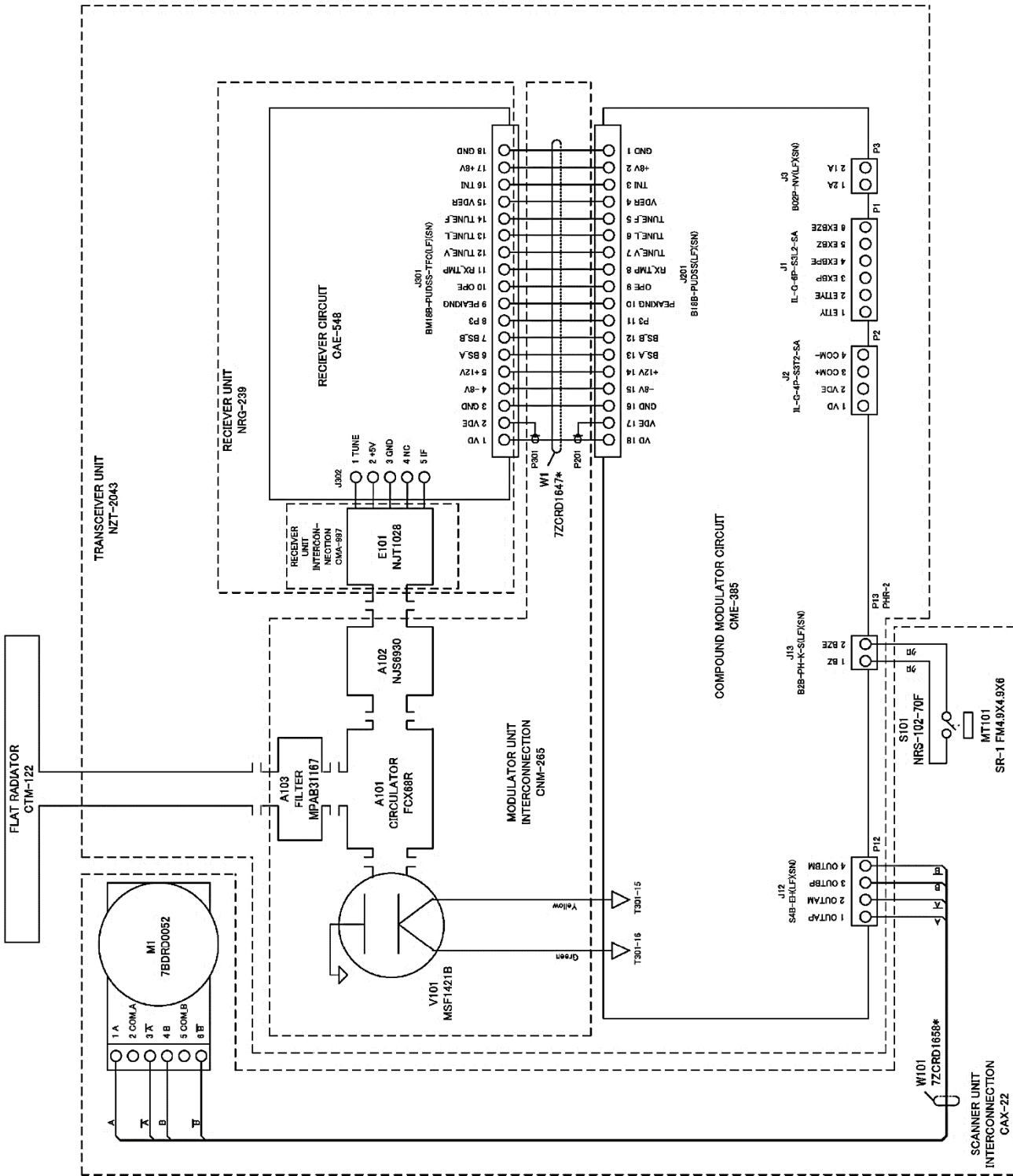

7ZPDR00000*
 14
 15
 16
 17
 18
 19
 20
 21
 22
 23
 24
 25
 26
 27
 28
 29
 30
 31
 32
 33
 34
 35
 36
 37
 38
 39
 40
 41
 42
 43
 44
 45
 46
 47
 48
 49
 50
 51
 52
 53
 54
 55
 56
 57
 58
 59
 60
 61
 62
 63
 64
 65
 66
 67
 68
 69
 70
 71
 72
 73
 74
 75
 76
 77
 78
 79
 80
 81
 82
 83
 84
 85
 86
 87
 88
 89
 90
 91
 92
 93
 94
 95
 96
 97
 98
 99
 100
 101
 102
 103
 104
 105
 106
 107
 108
 109
 110
 111
 112
 113
 114
 115
 116
 117
 118
 119
 120
 121
 122
 123
 124
 125
 126
 127
 128
 129
 130
 131
 132
 133
 134
 135
 136
 137
 138
 139
 140
 141
 142
 143
 144
 145
 146
 147
 148
 149
 150
 151
 152
 153
 154
 155
 156
 157
 158
 159
 160
 161
 162
 163
 164
 165
 166
 167
 168
 169
 170
 171
 172
 173
 174
 175
 176
 177
 178
 179
 180
 181
 182
 183
 184
 185
 186
 187
 188
 189
 190
 191
 192
 193
 194
 195
 196
 197
 198
 199
 200
 201
 202
 203
 204
 205
 206
 207
 208
 209
 210
 211
 212
 213
 214
 215
 216
 217
 218
 219
 220
 221
 222
 223
 224
 225
 226
 227
 228
 229
 230
 231
 232
 233
 234
 235
 236
 237
 238
 239
 240
 241
 242
 243
 244
 245
 246
 247
 248
 249
 250
 251
 252
 253
 254
 255
 256
 257
 258
 259
 260
 261
 262
 263
 264
 265
 266
 267
 268
 269
 270
 271
 272
 273
 274
 275
 276
 277
 278
 279
 280
 281
 282
 283
 284
 285
 286
 287
 288
 289
 290
 291
 292
 293
 294
 295
 296
 297
 298
 299
 300
 301
 302
 303
 304
 305
 306
 307
 308
 309
 310
 311
 312
 313
 314
 315
 316
 317
 318
 319
 320
 321
 322
 323
 324
 325
 326
 327
 328
 329
 330
 331
 332
 333
 334
 335
 336
 337
 338
 339
 340
 341
 342
 343
 344
 345
 346
 347
 348
 349
 350
 351
 352
 353
 354
 355
 356
 357
 358
 359
 360
 361
 362
 363
 364
 365
 366
 367
 368
 369
 370
 371
 372
 373
 374
 375
 376
 377
 378
 379
 380
 381
 382
 383
 384
 385
 386
 387
 388
 389
 390
 391
 392
 393
 394
 395
 396
 397
 398
 399
 400
 401
 402
 403
 404
 405
 406
 407
 408
 409
 410
 411
 412
 413
 414
 415
 416
 417
 418
 419
 420
 421
 422
 423
 424
 425
 426
 427
 428
 429
 430
 431
 432
 433
 434
 435
 436
 437
 438
 439
 440
 441
 442
 443
 444
 445
 446
 447
 448
 449
 450
 451
 452
 453
 454
 455
 456
 457
 458
 459
 460
 461
 462
 463
 464
 465
 466
 467
 468
 469
 470
 471
 472
 473
 474
 475
 476
 477
 478
 479
 480
 481
 482
 483
 484
 485
 486
 487
 488
 489
 490
 491
 492
 493
 494
 495
 496
 497
 498
 499
 500
 501
 502
 503
 504
 505
 506
 507
 508
 509
 510
 511
 512
 513
 514
 515
 516
 517
 518
 519
 520
 521
 522
 523
 524
 525
 526
 527
 528
 529
 530
 531
 532
 533
 534
 535
 536
 537
 538
 539
 540
 541
 542
 543
 544
 545
 546
 547
 548
 549
 550
 551
 552
 553
 554
 555
 556
 557
 558
 559
 560
 561
 562
 563
 564
 565
 566
 567
 568
 569
 570
 571
 572
 573
 574
 575
 576
 577
 578
 579
 580
 581
 582
 583
 584
 585
 586
 587
 588
 589
 590
 591
 592
 593
 594
 595
 596
 597
 598
 599
 600
 601
 602
 603
 604
 605
 606
 607
 608
 609
 610
 611
 612
 613
 614
 615
 616
 617
 618
 619
 620
 621
 622
 623
 624
 625
 626
 627
 628
 629
 630
 631
 632
 633
 634
 635
 636
 637
 638
 639
 640
 641
 642
 643
 644
 645
 646
 647
 648
 649
 650
 651
 652
 653
 654
 655
 656
 657
 658
 659
 660
 661
 662
 663
 664
 665
 666
 667
 668
 669
 670
 671
 672
 673
 674
 675
 676
 677
 678
 679
 680
 681
 682
 683
 684
 685
 686
 687
 688
 689
 690
 691
 692
 693
 694
 695
 696
 697
 698
 699
 700
 701
 702
 703
 704
 705
 706
 707
 708
 709
 710
 711
 712
 713
 714
 715
 716
 717
 718
 719
 720
 721
 722
 723
 724
 725
 726
 727
 728
 729
 730
 731
 732
 733
 734
 735
 736
 737
 738
 739
 740
 741
 742
 743
 744
 745
 746
 747
 748
 749
 750
 751
 752
 753
 754
 755
 756
 757
 758
 759
 760
 761
 762
 763
 764
 765
 766
 767
 768
 769
 770
 771
 772
 773
 774
 775
 776
 777
 778
 779
 780
 781
 782
 783
 784
 785
 786
 787
 788
 789
 790
 791
 792
 793
 794
 795
 796
 797
 798
 799
 800
 801
 802
 803
 804
 805
 806
 807
 808
 809
 810
 811
 812
 813
 814
 815
 816
 817
 818
 819
 820
 821
 822
 823
 824
 825
 826
 827
 828
 829
 830
 831
 832
 833
 834
 835
 836
 837
 838
 839
 840
 841
 842
 843
 844
 845
 846
 847
 848
 849
 850
 851
 852
 853
 854
 855
 856
 857
 858
 859
 860
 861
 862
 863
 864
 865
 866
 867
 868
 869
 870
 871
 872
 873
 874
 875
 876
 877
 878
 879
 880
 881
 882
 883
 884
 885
 886
 887
 888
 889
 890
 891
 892
 893
 894
 895
 896
 897
 898
 899
 900
 901
 902
 903
 904
 905
 906
 907
 908
 909
 910
 911
 912
 913
 914
 915
 916
 917
 918
 919
 920
 921
 922
 923
 924
 925
 926
 927
 928
 929
 930
 931
 932
 933
 934
 935
 936
 937
 938
 939
 940
 941
 942
 943
 944
 945
 946
 947
 948
 949
 950
 951
 952
 953
 954
 955
 956
 957
 958
 959
 960
 961
 962
 963
 964
 965
 966
 967
 968
 969
 970
 971
 972
 973
 974
 975
 976
 977
 978
 979
 980
 981
 982
 983
 984
 985
 986
 987
 988
 989
 990
 991
 992
 993
 994
 995
 996
 997
 998
 999
 1000

A.2 Display Unit Block Diagrams

A.2.1 NDC-1678/A process unit

NDC-1678/A 処理部 機内配線図
Radar Process Unit Inter-Connection

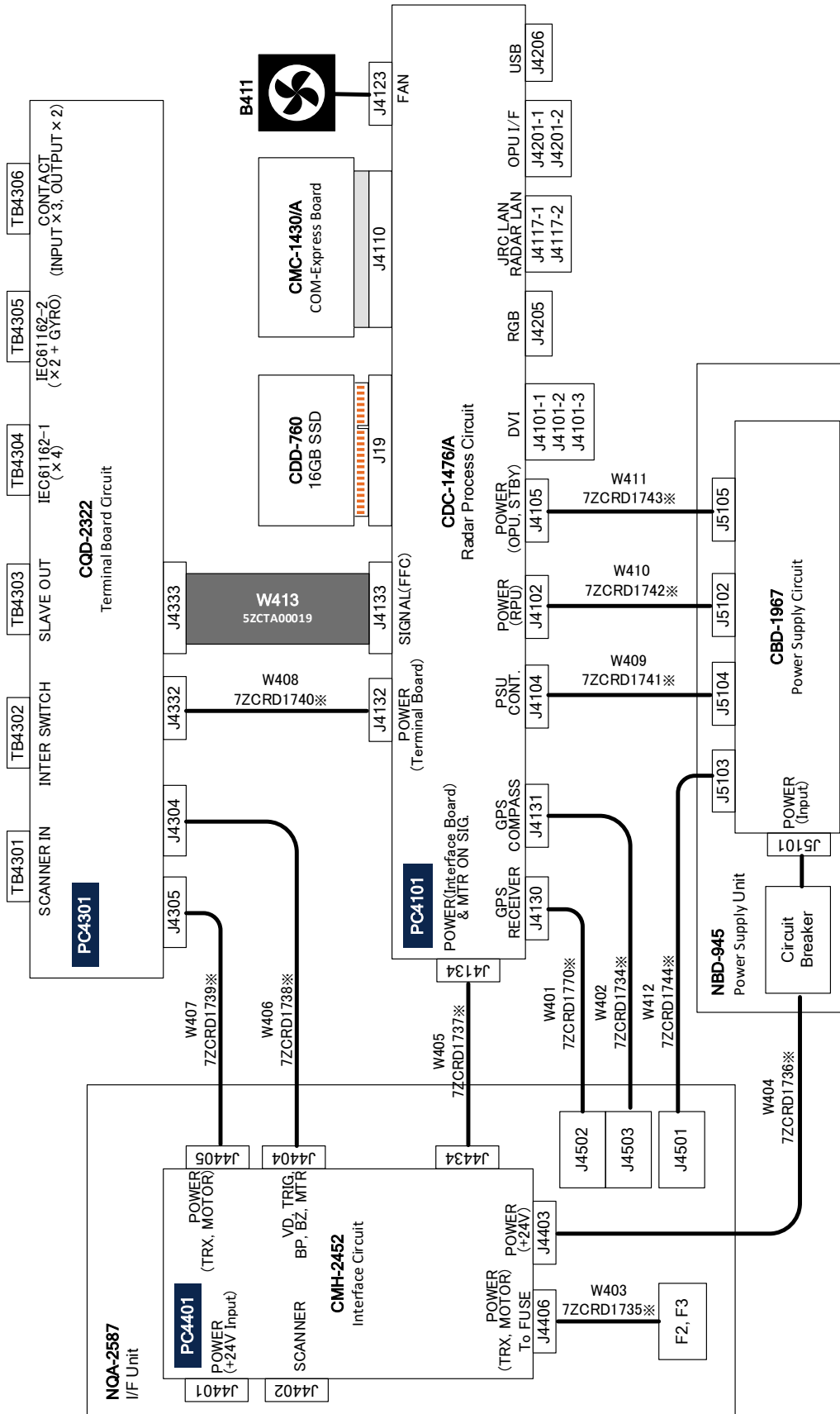

The "*" mark at the end of the cable model name indicates the version of the cable.
Blank or A to Z alphabets are written in the "*" mark part.
When "A" and "B" are compared, it means that "B" is a newer version.

A.2.2 NQA-2587 input/output unit

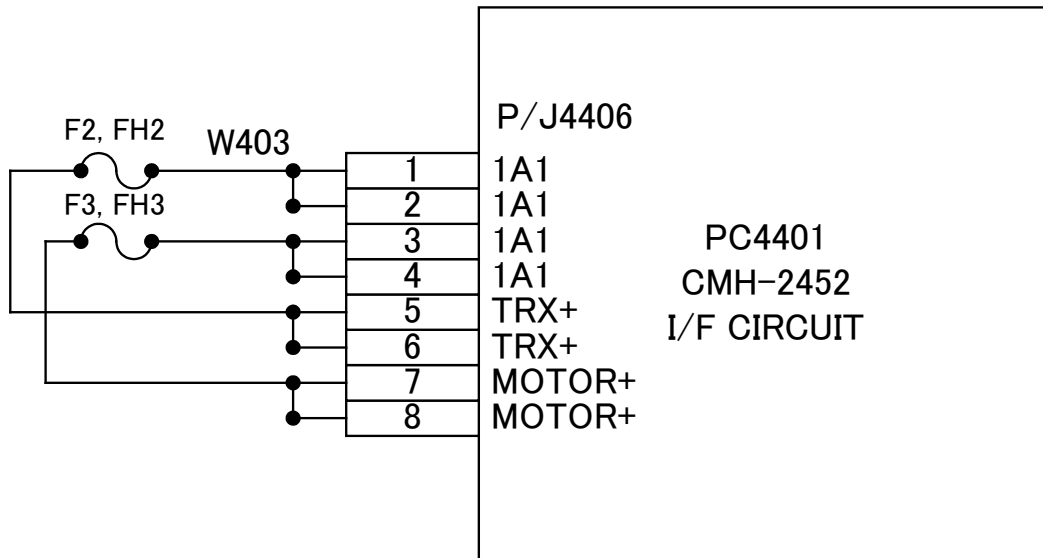

A.2.3 NCE-5794 operation unit

NCE-5794 標準操作部内配線図
Operation Unit Inter-Connection

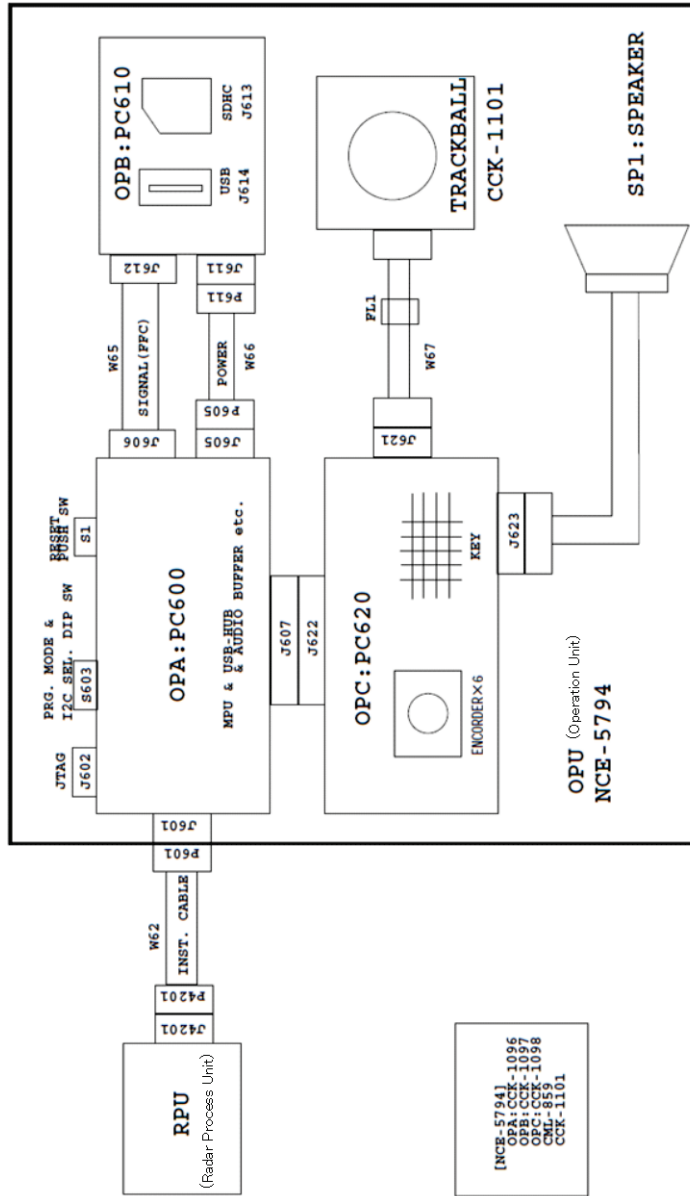

W621 : H-7ZCN4152*
W65 : 20706 ASFBC-SB-P-05-K1U-20-146 T 2.1/6.1BL
W66 : H-7ZCRD1732*
W67 : H-7ZCRD1771*
SPI1 : U238S44-B
FL1 : GRFC-3

RPU - OPU Installation Cable
OPA - OPB FFC Cable
OPA - OPB PowerSupply Cable
OPC - Trackball Cable
SPEAKER
FILTER

The "*" mark at the end of the cable model name indicates the version of the cable.
Blank or A to Z alphabets are written in the "*" mark part.
When "A" and "B" are compared, it means that "B" is a newer version.

Appendix B Alert List

When an alert occurs, alert information is displayed in the alert notification area.

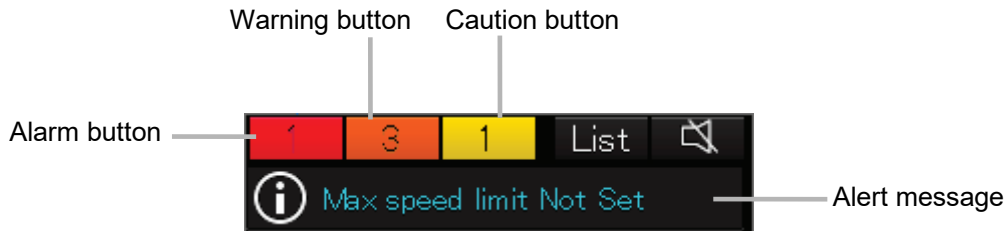

The numbers displayed in the buttons indicate the number of such alerts that have occurred.

Memo

The alert button of a category that has not occurred will not be displayed.

The display colours of alert messages are defined as follows according to the type and seriousness of alerts.

| Alert Type | Alert Class (Seriousness) | Display Colour | Alert Display Status | Alert Sound |
|---|---------------------------|----------------|---|---|
| Alarms (An alert indicating a state asking sailors to pay immediate attention and take immediate action.) | Alarms | Red | Before alarm acknowledgement: Blinking After alarm acknowledgement: Lighting | 3 short audible signals. Interval of audible signal is 8 seconds. |
| Warnings (An alert indicating that the state has changed, which although is not immediately dangerous, but may become so in the near future if no action is taken. Warnings are alerts displayed for preventing possible future hazardous states.) | Warnings | Orange | Before warning acknowledgement: Blinking After warning acknowledgement: Lighting | once 2 short audible signals. |
| Cautions (Although these are neither alarms nor warnings, these alerts indicate that it is necessary to pay more than normal attention to cautions, statuses, or to the supplied information.) | Cautions | Yellow | Lighting | No sound |
| No Alarm | - | Green | - | - |

The list of alerts is shown below.

Types of alert categories is shown below.

Category A: Critical alerts that can only be acknowledged or silenced by the device that generated them.

Category B: All alerts except category A

B.1 Alarms

| Message | Condition to raise | Condition to rectify | Category | Description |
|-----------------|---|--|----------|--|
| CPA/TCPA(AIS) | AIS target was detected within a preset CPA/TCPA limit. | AIS target exceeded a preset CPA/TCPA limit. | A | CPA/TCPA alert (AIS) |
| CPA/TCPA(TT) | TT target was detected within a preset CPA/TCPA limit. | TT target exceeded a preset CPA/TCPA limit. | A | CPA/TCPA alert (TT) |
| Cross Track | The off-track distance from the planned route exceeded the limit. | The off-track distance from the planned route was below the limit. | A | - |
| Dragging anchor | Dragging anchor warning was not acknowledged for 120 seconds. | Own ship entered the dragging anchor monitoring area. | A | The ship has left the dragging anchor monitoring area. |

B.2 Warnings

| Message | Condition to raise | Condition to rectify | Category | Description |
|---------------------------|--|---|----------|---|
| AIS MAX Capacity | The AIS target count exceeded the maximum target display count. | The AIS target count is less than the maximum target display count. | A | - |
| Antenna Reverse Rotation | Reverse rotation of the antenna was detected. | Antenna rotation is normal condition. | B | - |
| Antenna Safety Switch Off | Safety switch of antenna is off. | Safety switch of antenna is on. | B | - |
| Arrived at WOL | Own ship has arrived at WOL. | Warning is acknowledged. | A | - |
| Arrived at WPT | Own ship has arrived at WPT. | Warning is acknowledged. | A | - |
| Dragging anchor | Own ship exited from the dragging anchor monitoring area. If Dragging anchor warning is not acknowledged for 2 minutes, the warning escalates to Dragging anchor alarm. | Own ship entered the dragging anchor monitoring area. | A | - |
| Lost AIS | AIS data is lost. | AIS data is received. | B | - |
| Lost AIS Target | The AIS target is lost. | Warning is acknowledged. | A | The current position is predicted based on the data received last. |
| Lost Antenna Control | Antenna control is lost. | Antenna control is normal condition. | B | - |
| Lost COG/SOG | COG/SOG data is lost. | COG/SOG data is received. | B | - |
| Lost HDG | Heading data is lost. | Heading data is received. | B | - |
| Lost OPU | OPU failure is occurred. | OPU failure is repaired. | B | - |
| Lost POSN | Position data is lost. | Position data is received. | B | - |
| Lost RADAR Echo | RADAR echo cannot be displayed. | RADAR echo data is received. | B | - |
| Lost STW | STW data is lost. | STW data is received. | B | - |
| Lost TT REF Target | The referential TT target is lost. | Warning is acknowledged. | A | - |
| Lost TT Target | The TT target is lost. | Warning is acknowledged. | A | It is because the reception condition is bad or the target has entered other object's shadow. |

| | | | | |
|---------------------|--|--|---|--|
| New AIS Target | New AIS target is detected within AZ. | Warning is acknowledged. | A | The target of AIS has been complemented and activated. |
| New TT Target | New TT target is detected within AZ. | Warning is acknowledged. | A | The target of TT has been complemented. |
| RADAR Alarm(In) | RADAR echo above the threshold level is occurred at the alarm area. | There are no more RADAR echoes above the threshold in the alarm area. | B | - |
| RADAR Alarm(Out) | RADAR echo above the threshold level is disappeared at the alarm area. | There are no more RADAR echoes above the threshold outside alarm area. | B | - |
| TT MAX Capacity | The TT target count exceeded the maximum target display count. | The TT target count is less than the maximum target display count. | A | - |
| TT Out of Range | The TT target exceeded 32NM. | The TT target moved within 32NM. | A | - |
| VDR Delivery Failed | Equipment cannot send the image to VDR for 1 minute. | Equipment can send the image to VDR for more than 1 minute. | B | Delivery of captured image for VDR failed. |

B.3 Cautions

| Message | Condition to raise | Condition to rectify | Category | Description |
|----------------------------|---|--|----------|---|
| AIS 95% Capacity | The AIS target count exceeded 95% of the maximum target display count. | The AIS target count is less than 95% of the maximum target display count. | B | - |
| Antenna Rotating | ICE class standby of standby setting is ON. | ICE class standby of standby setting is OFF. | B | The radar antenna is rotating. |
| Lost AIS | AIS data is lost. | AIS data is received. | B | - |
| Lost COG/SOG | COG/SOG data is lost. | COG/SOG data is received. | B | - |
| Lost DATUM | DATAM data is lost. | DATUM data is received. | B | - |
| Lost Depth | Depth data is lost. | Depth data is received. | B | - |
| Lost External TT | The external TT target data is lost. | The external TT target data is received. | B | - |
| Lost ISW | Interswitch data is lost. | Interswitch data is received. | B | - |
| Lost ISW TT | The TT target data from interswitch is lost. | The TT target data from interswitch is received. | B | While using the Simple ISW (LAN) function slave state, TT data cannot be displayed. There is a possibility that the indicator of Master side is using "Reference Target" function. |
| Lost Multi Current | Multi Current data is lost. | Multi Current data is received. | B | - |
| Lost ROT | ROT data is lost. | ROT data is received. | B | - |
| Lost STW | STW data is lost. | STW data is lost. | B | - |
| On Trial(CPA/TCPA) | AIS or TT target was detected within a preset CPA/TCPA limit on trial mode. | AIS or TT target exceeded a preset CPA/TCPA limit on trial mode. | B | It is in trial. |
| RADAR-LAN(IP Duplication) | IP address on the RADAR-LAN network is duplicated. | IP address duplication on the RADAR-LAN network is eliminated. | B | Network video function can not be used. |
| RADAR-LAN(Link-Down) | The RADAR-LAN port cannot link up. | The RADAR-LAN port can link up. | B | Network Video function cannot be used. |
| RADAR-LAN(Link-Speed) | The RADAR-LAN port cannot link up by 1000Base-T. | The RADAR-LAN port can link up by 1000Base-T. | B | Network Video function cannot be used. |
| RADAR-LAN(Sweep Tx Failed) | Sweep quality on the RADAR-LAN network is degraded. | Sweep quality on the RADAR-LAN network is restored. | B | - |
| RADAR-LAN(TT Option) | The TT option of the equipment on the | The TT option of the equipment on the | B | While using the Simple ISW (LAN) |

| | | | | |
|-----------------|---|---|---|--|
| Mismatch) | RADAR-LAN network is different. | RADAR-LAN network is same. | | function slave state, TT data cannot be displayed. |
| TT 95% Capacity | The TT target count exceeded 95% of the maximum target display count. | The TT target count is less than 95% of the maximum target display count. | B | - |

B.4 List of Alert escalation

There is unacknowledged alert that escalates as follows.

- Warning to Alarm

If warning is not acknowledged, the warning escalates to alarm.

- Warning to Warning

An unacknowledged warning will be generated repeatedly until it is acknowledged.

The alerts to escalation are as shown below.

| Cause | Escalation | Time | Explanation |
|-------------------------|--------------------|---------------|---|
| Dragging anchor warning | Warning to Alarm | 120s | If dragging anchor warning is not acknowledged for 2 minutes, the warning escalates to dragging anchor alarm. |
| Other warning | Warning to Warning | 60s (Default) | An unacknowledged warning will be generated repeatedly until it is acknowledged. |

B.5 List of Alert with responsibility-transferred state















The responsibility-transferred state is a state for priority reduction. When the equipment managing the alert in the system requests a transfer of responsibility of alert, the requested equipment changes state of the alert to responsibility transferred.

The alerts with responsibility transferred states are as shown below.

| Cause | Priority | Category |
|---------------------------|----------|----------|
| Antenna Reverse Rotation | Warning | B |
| Antenna Safety Switch Off | Warning | B |
| Lost AIS | Warning | B |
| Lost Antenna Control | Warning | B |
| Lost COG/SOG | Warning | B |
| Lost HDG | Warning | B |
| Lost OPU | Warning | B |
| Lost POSN | Warning | B |
| Lost RADAR Echo | Warning | B |
| Lost STW | Warning | B |
| VDR Delivery Failed | Warning | B |

B.6 List of Alert Icons

The alert icons displayed in the alert status area are listed below.

| No. | Name of alert icon | Functional outline | Alert icon |
|-----|---|--|---|
| 1 | Active – unacknowledged alarm | A flashing red triangle. A symbol of loudspeaker in the middle of the triangle. |  |
| 2 | Active – silenced alarm | A flashing red triangle. A symbol as in icon number 1 with a prominent diagonal line above it. |  |
| 3 | Active – acknowledged alarm | A red triangle. An exclamation mark in the middle of the triangle. |  |
| 4 | Active - responsibility transferred alarm | A red triangle. An arrow pointing towards the right in the middle of the triangle. |  |
| 5 | Rectified – unacknowledged alarm | A flashing red triangle. A tick mark in the middle of the triangle. |  |
| 6 | Active - unacknowledged warning | A flashing yellowish orange circle. A symbol of loudspeaker in the middle of the circle. |  |
| 7 | Active – silenced warning | A flashing yellowish orange circle. A symbol as in icon number 6 with a prominent diagonal line above it. |  |
| 8 | Active – acknowledged warning | A yellowish orange circle. An exclamation mark in the middle of the circle. |  |
| 9 | Active - responsibility transferred warning | A yellowish orange circle. An arrow pointing towards the right in the middle of the circle. |  |
| 10 | Rectified – unacknowledged warning | A flashing yellowish orange circle. A tick mark in the middle of the circle. |  |
| 11 | Caution | A yellow square. An exclamation mark in the middle of the square. |  |
| a | Aggregation | A plus sign. To be presented together with icons number 1 to 11 |  |
| b | Acknowledge not allowed for alarm | A red triangle with a cross in the middle of triangle. To be presented together with icons number 1, 2 and 5. |  |
| c | Acknowledge not allowed for warning | A yellowish orange circle with a cross in the middle of circle. To be presented together with icons number 6, 7 and 10. |  |

Appendix C Setting the Inter switch

C.1 Overview

C.1.1 Overview

The Inter switch NQE-3141 is equipment that makes it possible to freely select several radar display units provided in the bridge and the several radar antennas with different properties.

Even when the power supply of the display unit has been switched OFF or has become faulty, it is possible to operate the radar antennas from other display units.

When it has become impossible to use the Inter switch, it is possible to carry out operations independently.

The selection can be made up to a maximum of 8 units.

When the radar antenna is switched, the following settings are read out.

| Setting | Reference |
|--------------------------------|---|
| Rough adjustment tuning | 14.2.1 Performing basic adjustments on the radar |
| Bearing adjustment | |
| Range adjustment | |
| Antenna height | 14.2.2 Adjusting Radar Antenna |
| TXRX settings | |
| Performance monitor adjustment | 14.2.3 Adjusting a radar performance monitor |
| Sector blank | 14.2.4 Setting Sector Blank |
| Radar antenna position | 14.3.1 Verifying/Setting CCRP (Consistent Common Reference Point) |

The setting of each of coarse adjustment tuning, tuning peak setting, tuning indication level, bearing adjustment, monitor transmission level (performance monitor adjustment), Tune Indicator (TXRX adjustment), and Sector Blank is read from the antenna at switching.

Other settings are read from the indicator that is used.

The settings that are saved in the indicator are saved by antenna and the previous setting is read at the connection.

C.1.2 Checking the connection status with the connected radar antennas

The status of connection with the connected radar antenna is displayed by the Inter switch connection change button of the Radar system information.

Memo

Always a display unit that becomes the master is necessary for making a slave connection.
When putting a slave display unit in the transmit state, it is necessary to put the master display unit in the transmit state.



The name of the connected radar antenna is displayed in the upper part.
The connection state is displayed in the lower part.

Memo

In simple Inter switch mode, only the connection status is displayed.

Connection state

[Master]: The state in which the display unit can control the radar antenna.

[Slave]: The control of the radar antenna is not possible.

In the [slave] state, transmit/stop, and pulse length change cannot be made. Also, there will be restrictions on the usable range.

C.2 Inter switch Operations

When changing the connection pattern, carry out the operations according to the following flow.

C.2.1 Flow of operations

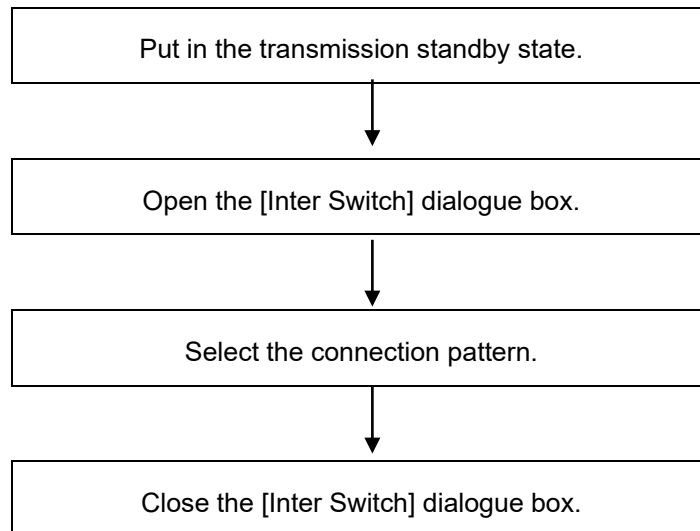

C.2.2 Opening the [Inter Switch] dialogue box

Memo



The [Inter Switch] dialogue can be displayed in the Transmission Not Ready state or preheat state. When transmission is not ready, "Preheat" or "Standby (disable)" is displayed on the Standby/Transmission change button.

- 1 In the transmission state, click on the Standby/Transmission change button.**
"Standby" is displayed on the button and the equipment is set to Transmission Not Ready state. If the equipment is already in the Transmission Not Ready state, this operation is not required.
- 2 Click the Change Inter switch connection button.**
The [Inter Switch] dialogue box is displayed.

The connection state between the current radar antenna and the display unit obtained by communication with the Inter switch is displayed in the [Inter Switch] dialogue box.

C.2.3 Checking the connection pattern

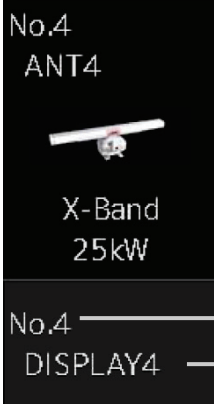
■ When connecting 3 to 4 radar antennae (extension) × 3 to 8 display units

| Item | Description |
|---------|--|
| Antenna | <p>The connected radar antennas are displayed.</p>  <p> No.4 — ISW port number ANT4 — Name of radar antenna X-Band — Radar antenna band name 25kW — Transmission output </p> |
| Master | <p>Displays radar antenna to which the master display units are respectively connected. For changing the combinations of master display units and radar antennas, refer to "C.2.4 Changing the connection pattern".</p>  <p> No.4 — ISW port number DISPLAY4 — Name of master display unit </p> |
| Slave | <p>Displays radar antenna to which the slave display units are respectively connected. For changing the combinations of slave display units and radar antennas, refer to "C.2.4 Changing the connection pattern".</p>  <p> No.5 — ISW port number DISPLAY5 — Name of slave display unit </p> |

| Item | Description |
|-------------------------|---|
| [Edit Name] button | When this button is clicked, a dialogue box is displayed for changing the names of the radar antennas and display units. Regarding the operations in the [Edit name] dialogue box, refer to "C.2.5 Changing the name of radar antenna or display unit". |
| [Save/Load file] button | When this button is clicked, the [Connection pattern file operation] dialogue box is displayed. The current connection pattern can be saved in the file or the connection pattern that has been saved previously can be loaded. For details of the [Connection pattern file operation] dialogue box, refer to "C.2.6 Using the set connection pattern". |
| [Set] button | When this button is clicked, the information of the set connection pattern is transmitted to the Inter switch. |

Memo

When a master or slave display unit button in which the error notification mark (ⓘ) is being displayed, the [Set] button becomes disabled.

For the details of error notification marks, refer to " C.2.3.1 About equipment defect mark (⊗) and error notification mark (ⓘ)".

C.2.3.1 About equipment defect mark (⊗) and error notification mark (ⓘ)

■ Equipment defect mark

This mark is displayed when the power supply of the radar antenna or the indicator unit is OFF or faulty. Check the cause and take corrective action.



■ Error notification mark

This mark is displayed when there is some error in the settings of a radar antenna or a display unit. Check the cause and take corrective action.

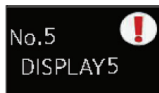

| Cause | Countermeasure |
|---|---|
| The master display unit does not exist or is faulty although the slave display unit is connected. | Connect the master display unit. |
| The master or slave display unit that is connected is not permitted to be connected to a radar antenna. | Check the setting by selecting [Service] - [Installation] - [Settings] - [Inter switch] on the menu and permit the connection to the display unit or connect another display unit whose connection to the radar antenna is permitted. |

C.2.4 Changing the connection pattern

- 1 Click the "Change Inter switch connection" button.**
The [Inter Switch] dialogue box is displayed.
- 2 Click the Master or Slave display unit selection button to be connected to the radar antenna.**
The selected display unit is highlighted.
- 3 Place the cursor to the destination of change and click it on.**
The currently selected display unit and the change destination display unit are interchanged.
- 4 If necessary, carry out the steps 2 and 3 for other display units.**
- 5 Click the [Set] button.**
The information of the set connection pattern is transmitted to the Inter switch.
- 6 Click the [×] button.**
The [Inter Switch] dialogue box is closed.

C.2.5 Changing the name of radar antenna or display unit

- 1 Click the [Edit name] button of the [Inter Switch] dialogue box.**
The [Edit name] dialogue box is displayed.
- 2 Click the name of the radar antenna or the display unit whose name is to be edited.**
A software full keyboard is displayed.
- 3 Change the name.**
The name can be input by using 1 to 8 alphanumeric characters and symbols.
- 4 Click the [Set] button.**
The name is changed.
- 5 Click the [×] button.**
The [Edit name] dialogue box is closed.

C.2.6 Using the set connection pattern

When connecting 3 to 8 radar antennas × 3 to 8 display units, it is possible to save the set connection pattern in a file. By reading out the saved connection pattern when required, it is possible to quickly change the connection pattern.

■ Saving a connection pattern

- 1 After setting a connection pattern, click the [Save/Load file] button of the [Inter Switch] dialogue box.**

The [Connection pattern file] dialogue is displayed.

- 2 Click the [Save] button.**

The [Input file name] dialogue is displayed.

- 3 Input the file name using the software full keyboard.**

- 4 Click the [OK] button.**

The connection pattern is saved, and the connection pattern name is displayed in the [Connecting pattern files] dialogue.

Memo

- The number of connection patterns that can be saved is up to 10 apart from the connection pattern set at the time of shipment from the factory (default).
- The pattern that is set at factory delivery (Default) cannot be changed.

■ Loading a connection pattern

- 1 Click the [Save/Load file] button of the [Inter Switch] dialogue box.**

The [Connecting pattern files] dialogue is displayed.

- 2 Click the connection pattern to be loaded.**

- 3 Click on the [Load] button.**

The loaded connection pattern is displayed in the [Inter Switch] dialogue.

■ Deleting a connection pattern file

- 1 Click the [Save/Load file] button of the [Inter Switch] dialogue box.**

The [Connecting pattern files] dialogue is displayed.

- 2 Click the connection pattern to be deleted.**

- 3 Click the [Delete] button.**

A dialogue box for confirmation of deleting is displayed.

- 4 Click the [OK] button in the dialogue box to delete.**

The selected connecting pattern file is deleted.

C.3 Reference

C.3.1 Pre-heat time after changing the connection pattern

After changing an Inter switch connection pattern has been completed, the pre-heat time varies depending on the connection state of the radar antenna and display unit before the change.

This is for protecting the electron tube that emits the radio waves.

- If the radar antenna was already being used before setting the new connection pattern, a pre-heat time will not be required.
- If the radar antenna was not being used before setting the new connection pattern, a pre-heat time will be required.

C.3.2 Precautions while changing the connection pattern

A setting of change of the connection pattern may not be reflected immediately. This is because time is taken for the internal processing and, in this case, repeat the changing operation again after leaving a time gap of several seconds.

C.3.3 Precautions during a slave connection

When the master display unit is not in the transmit state, it is not possible to put the slave display unit in the transmit state. Further, when the master display unit goes from the transmit state to the transmission standby state, the slave display unit is forcibly put into the transmission standby state. In this case, the message "ISW(Master Standby)" is displayed in the alert notification area and the notification sound is made.

It is not possible to carry out control of tuning in a slave display unit. Tuning is controlled by a master display unit.

Changing the distance range of a slave display unit is restricted by the range and transmission pulse length/transmission pulse repetition frequency of the master display unit. As a rule, although it is not possible to change the range of the slave display unit to a range larger than the range of the master display unit, depending on the range, if the transmission pulse length and the transmission pulse repetition frequency are the same, it may be possible to select a range larger than the range of the master display unit. When the master display unit makes the range smaller or changes the transmission pulse length, the range of the slave display unit may be changed forcibly. In this case, the message "Master Range CHG" is displayed in the alert notification area and the notification sound is made.

C.3.4 Setting during installation

■ Setting of the Inter switch circuit (CCL-304*)

The details of the dip switches SW11, SW12, and SW13 are given below.

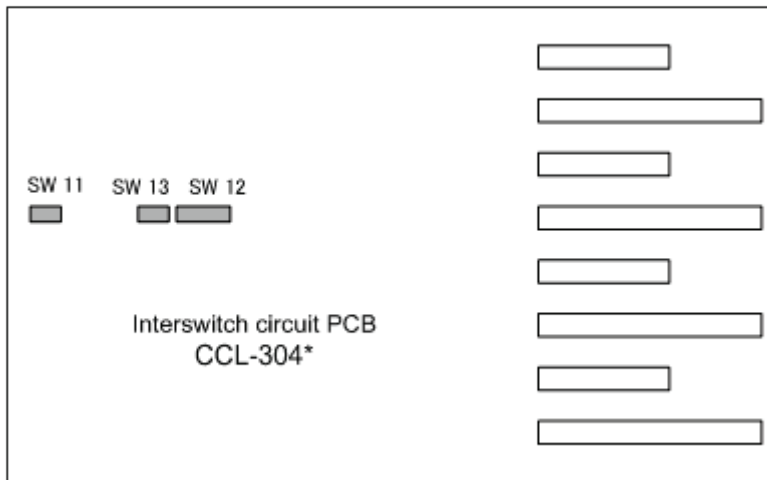

1) Setting of SW11 (setting of extended mode, master/slave)

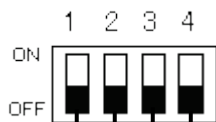

Extended mode setting

| 4 | Description |
|-----|---------------|
| ON | Extended mode |
| OFF | Normal mode |

Set to OFF when 4 or fewer units are connected.

Master/slave setting

| 3 | Description |
|-----|-------------|
| ON | Slave |
| OFF | Master |

During the extended mode, set to ON in the ISW board on the slave side.

Not used

| 1, 2 | Description |
|------|-------------|
| ON | Not used |
| OFF | Not used |

Normally set to OFF.

2) Setting of SW12 (Radar connection setting)

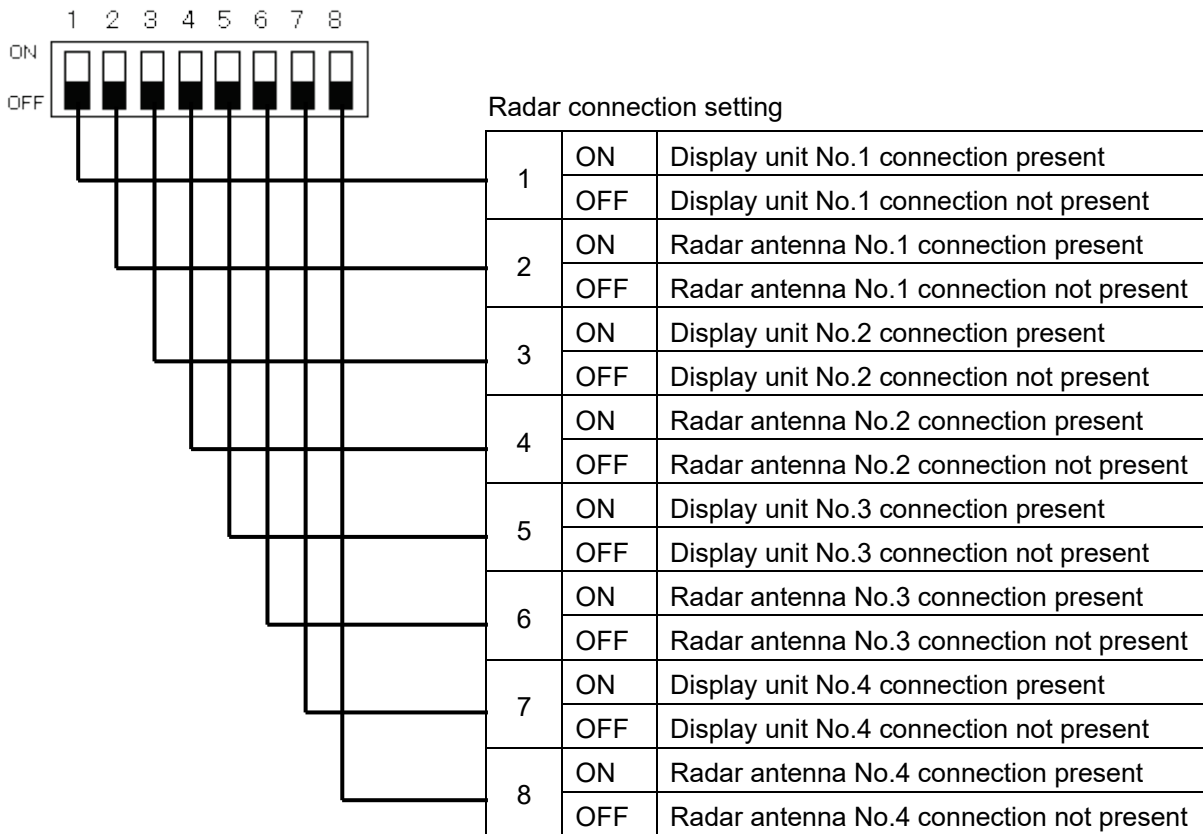

3) Setting of SW13 (Not used)

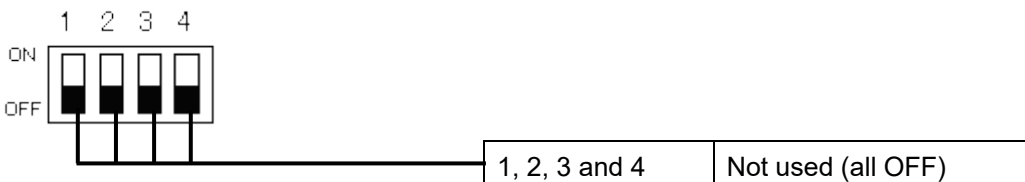

Memo

When setting the dip switches of the Inter switch circuit, turn OFF the main power supply of the Inter switch, and ensure safety before carrying out the setting.

Appendix D Menu List and Materials

D.1 Menu List

This section shows the menus and dialogue items of this equipment by target menu.

* Items that are enclosed by a frame of broken lines indicate the dialogue and window names that are displayed by selecting the relevant menu.

D.1.1 Anchor Watch

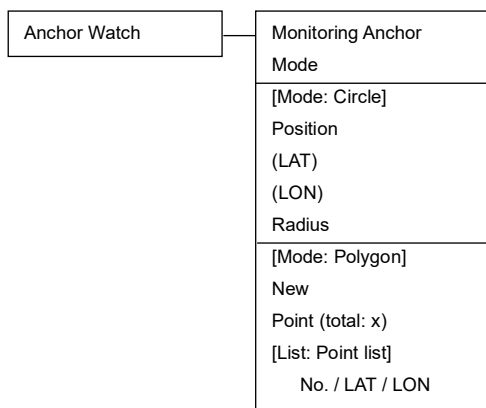

D.1.2 Chart

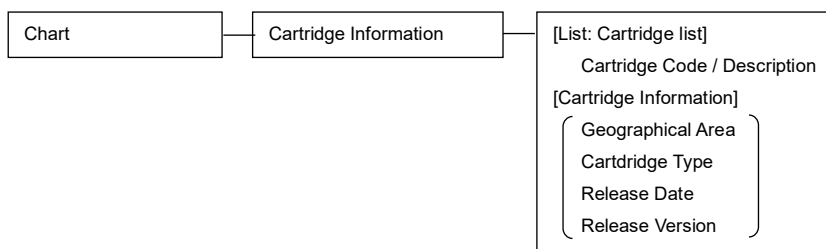

D.1.3 User Map

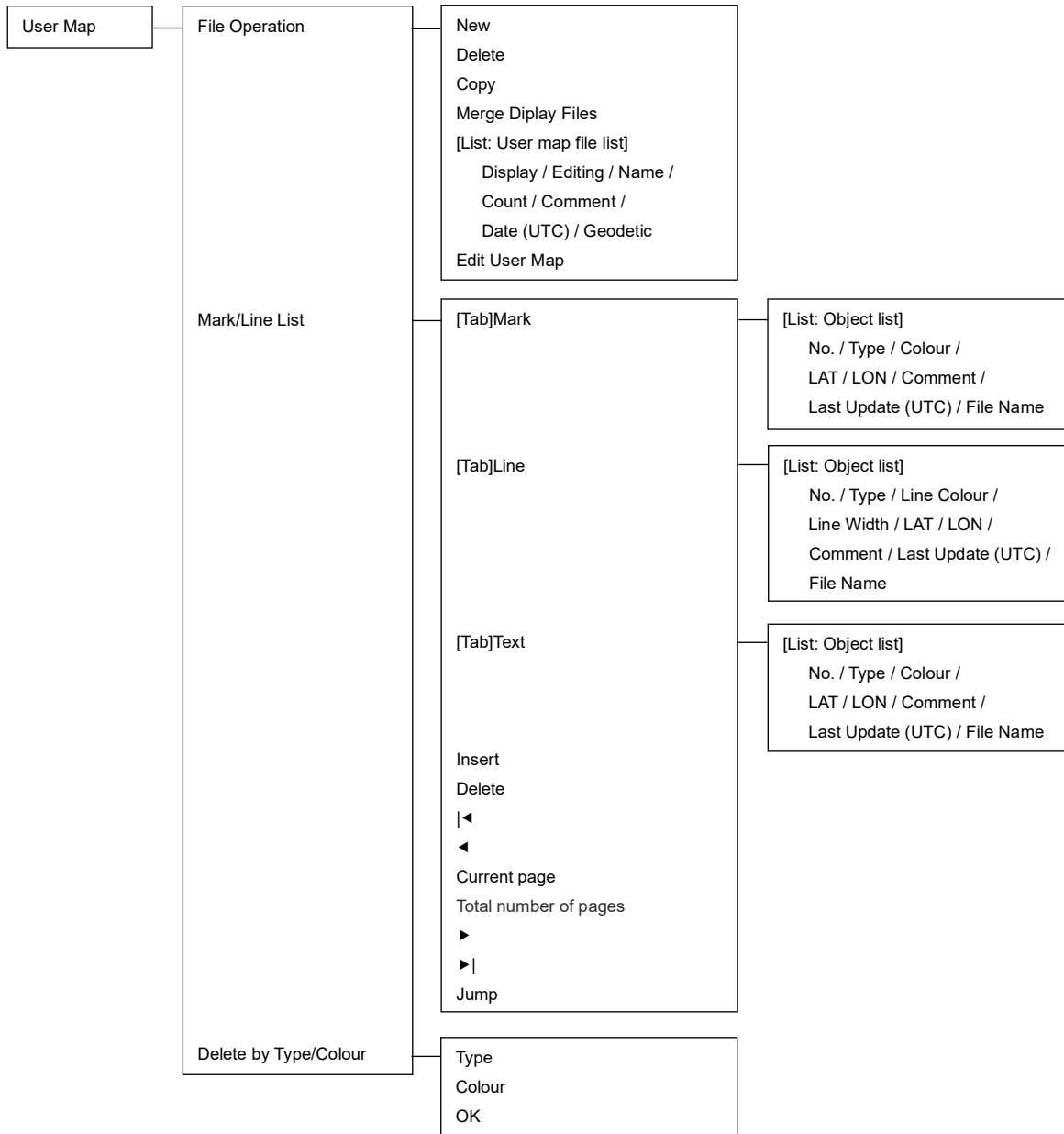

D.1.4 TT/AIS

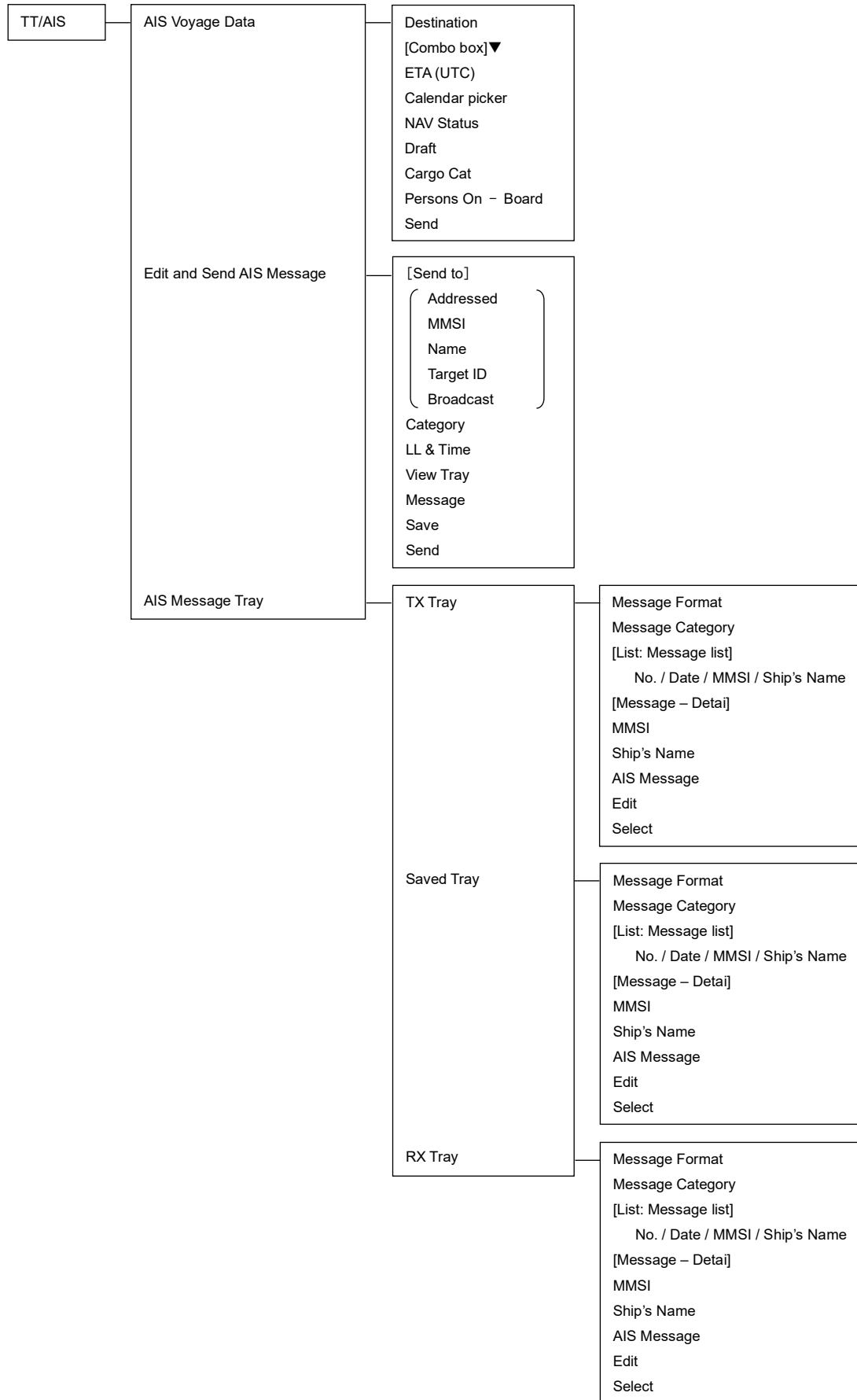

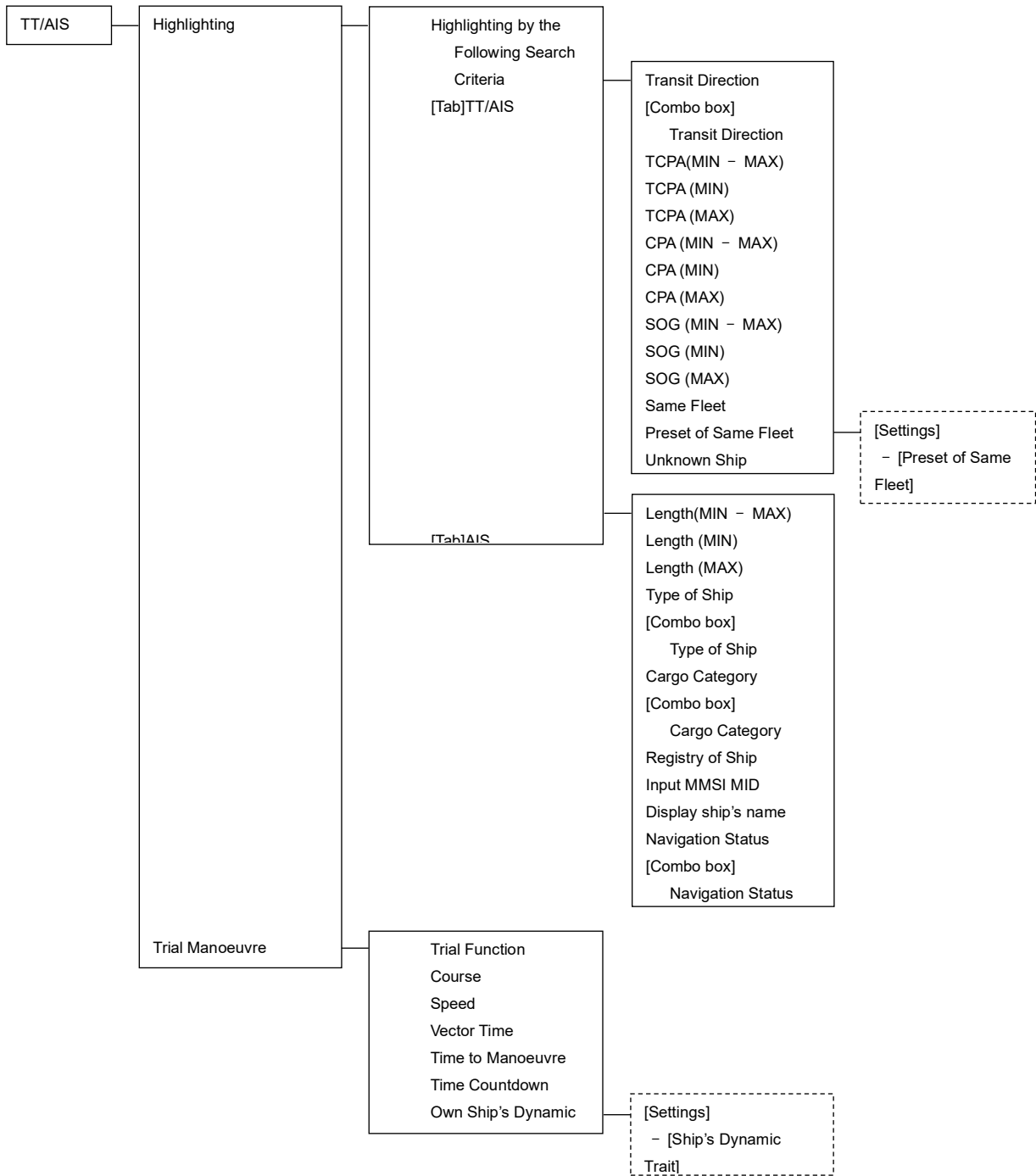

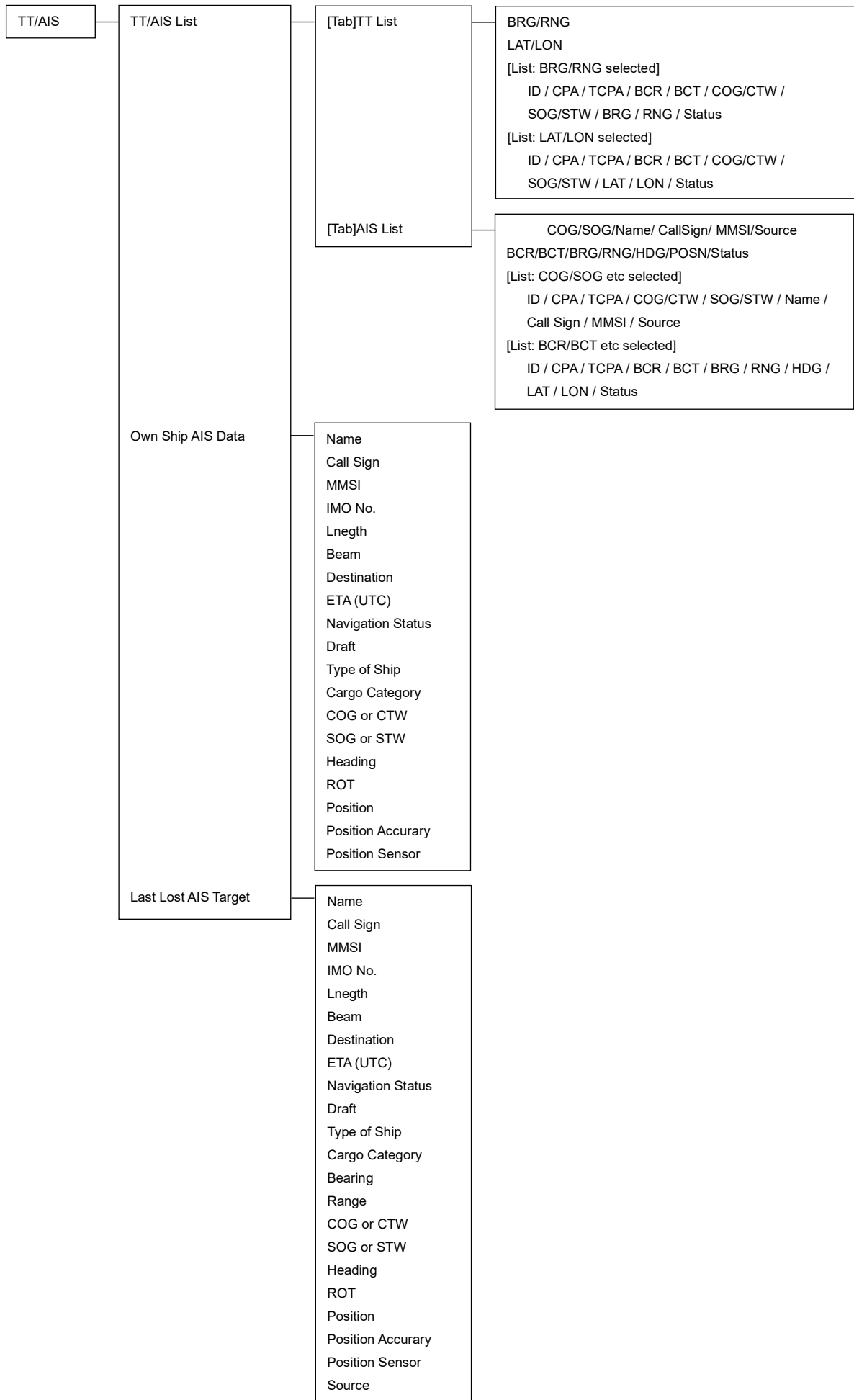

D.1.5 Tools

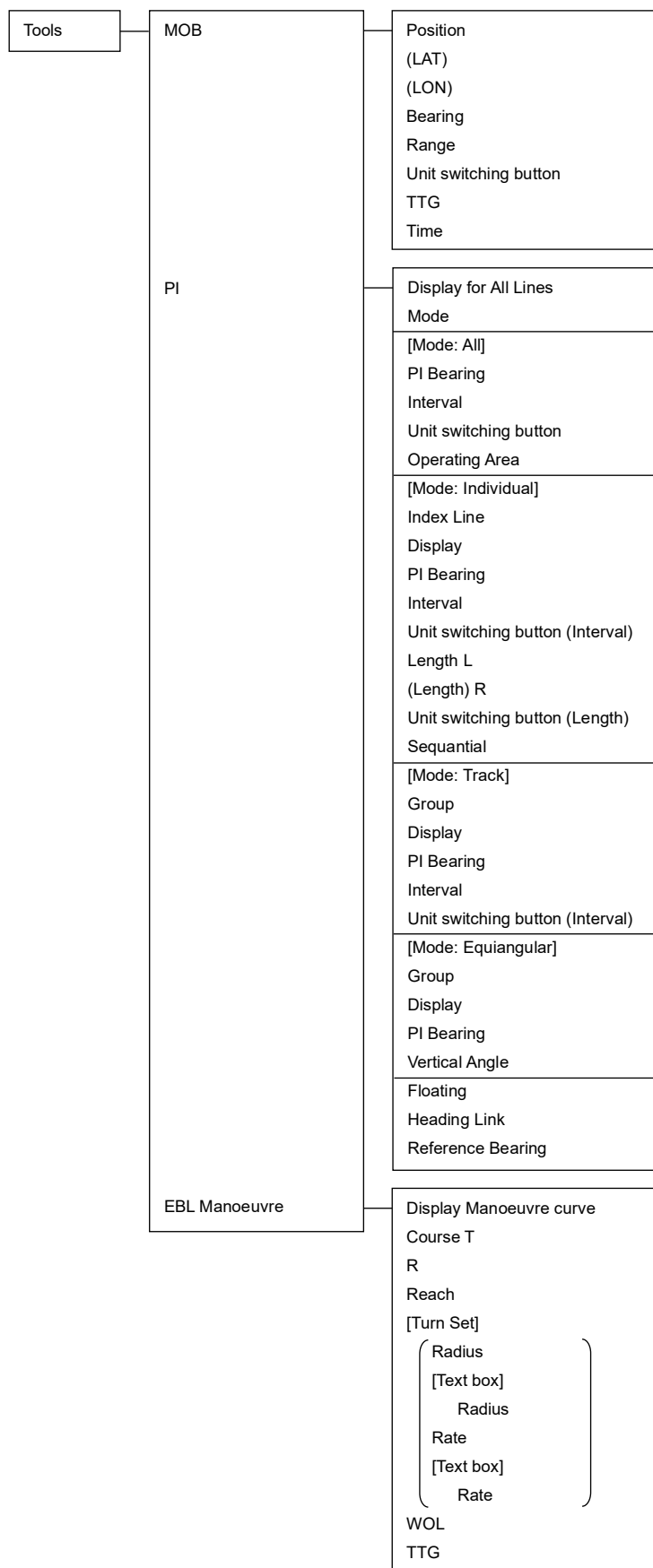

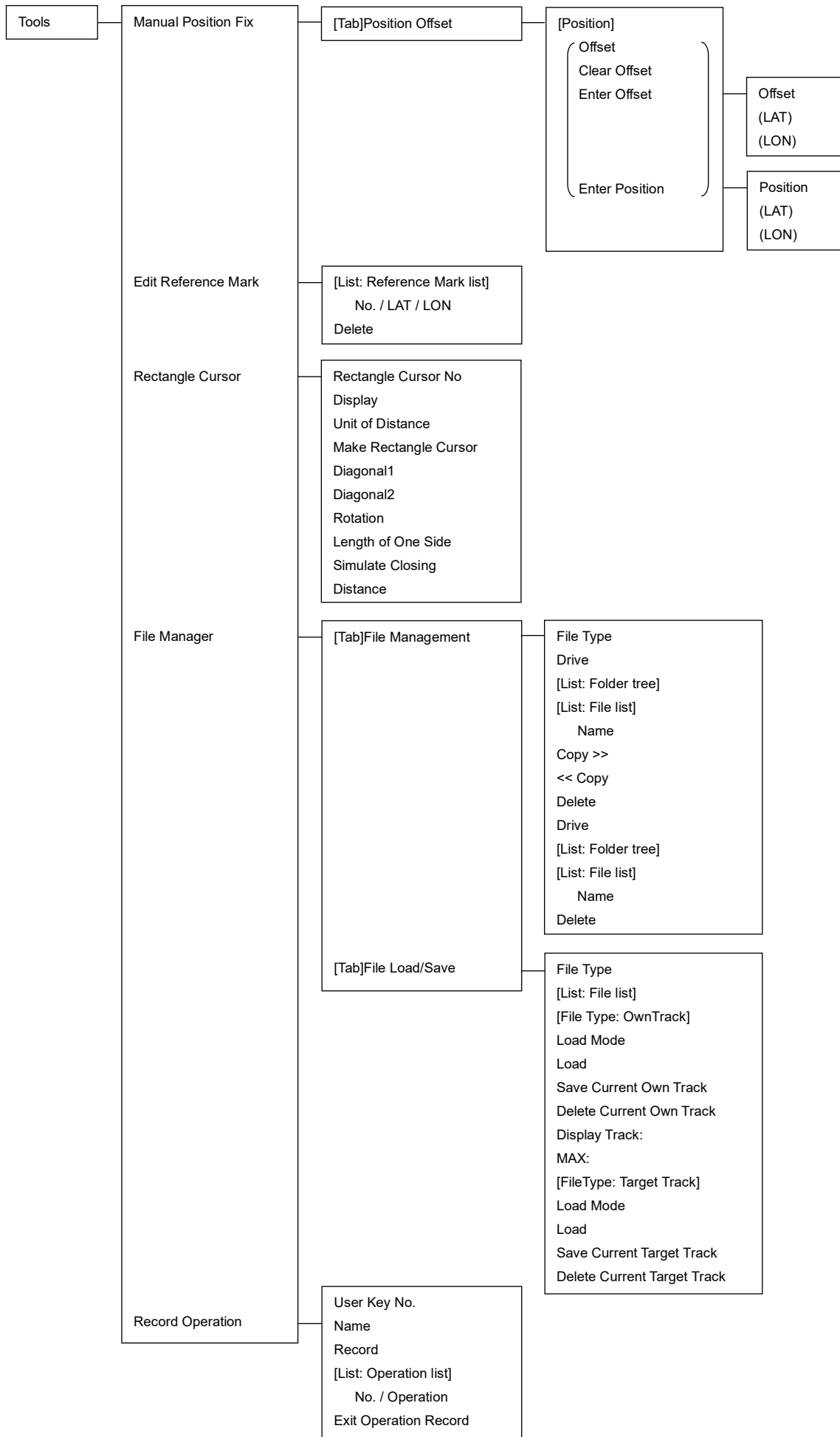

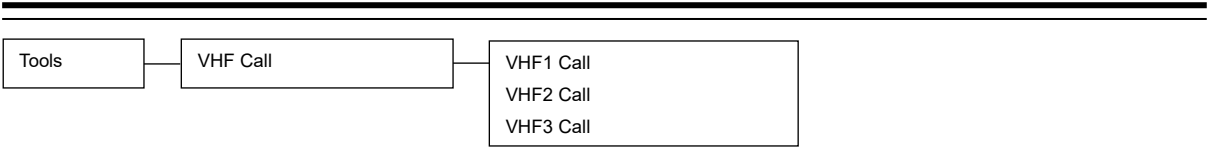

D.1.6 View

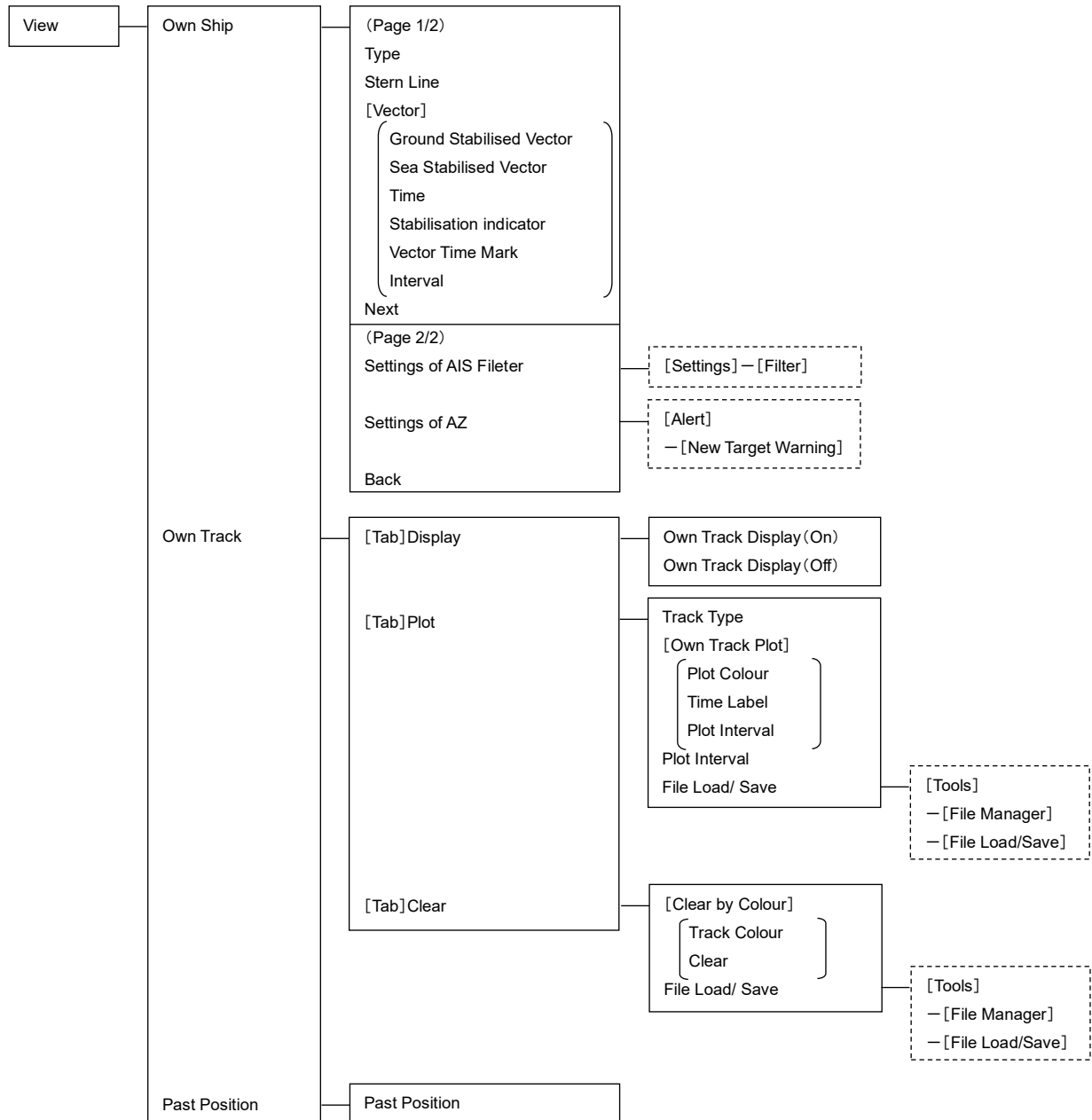

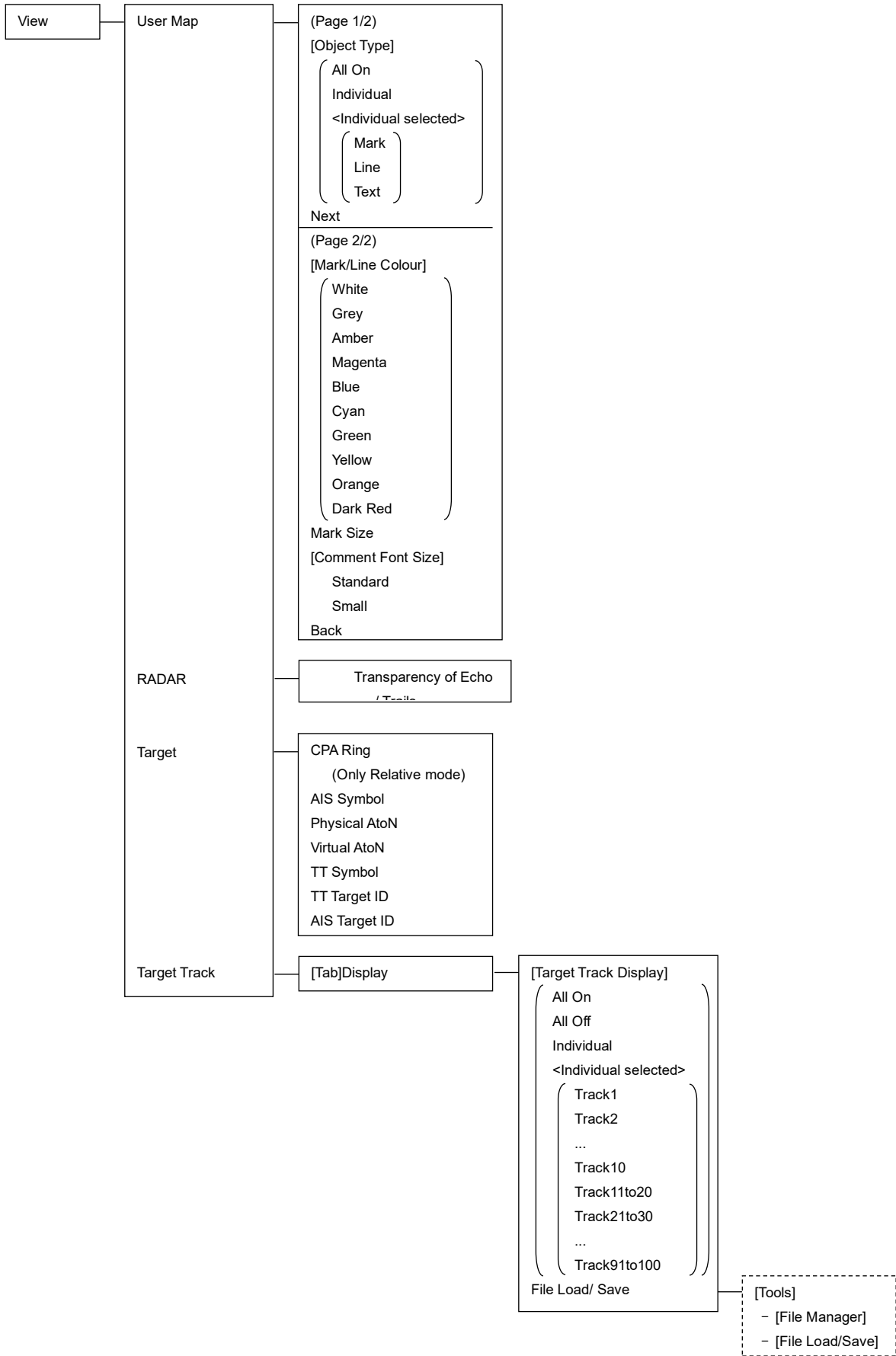

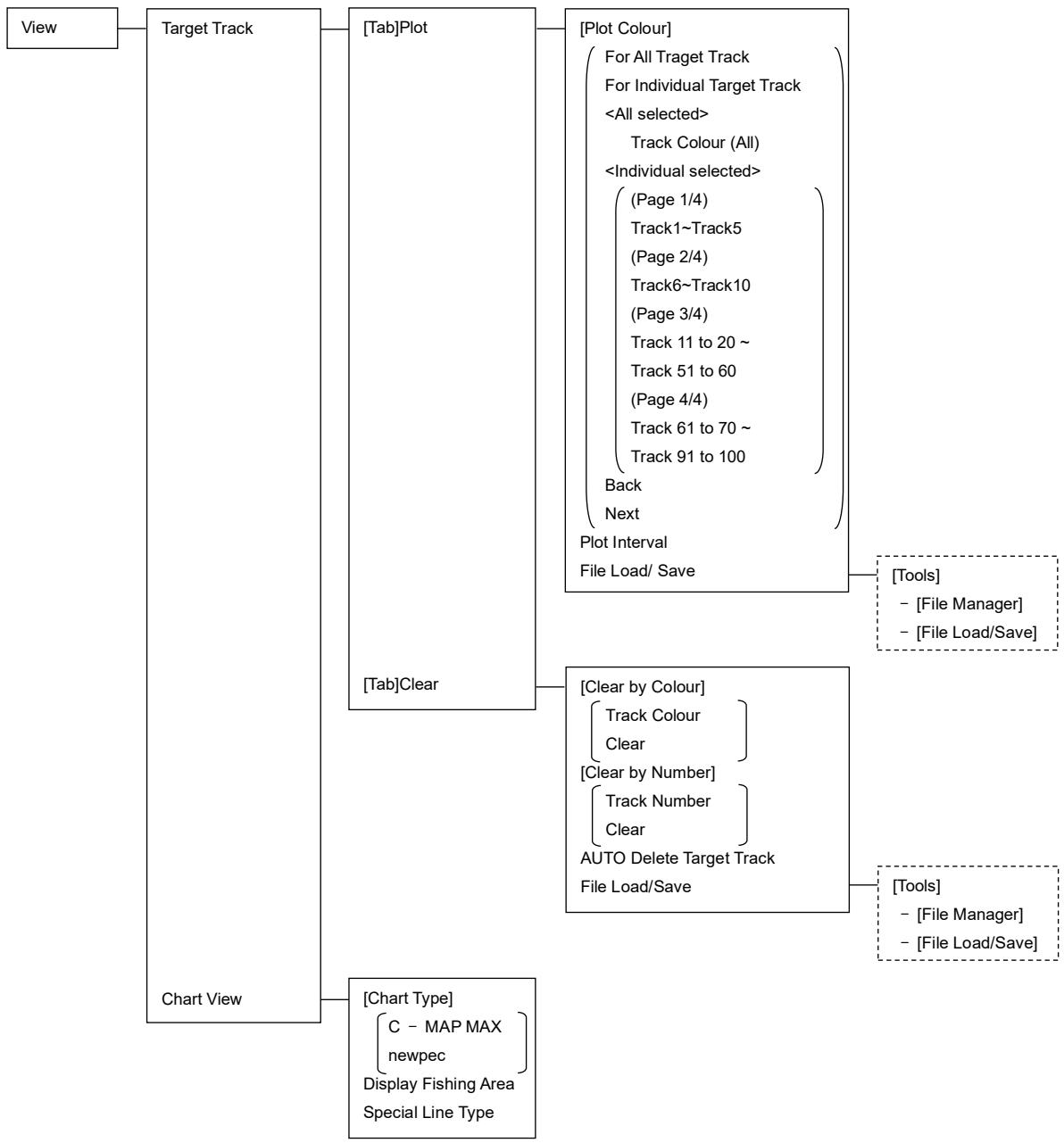

View

C-MAP MAX

(Page 1/4)
[Depth Shading]
(Mode
[Highlighting Depth Area]
(Minimum Depth
Maximum Depth
Safety Contour))
Next

(Page 2/4)
[Land Settings]
(Point of Interested
Land Elevation
Roads
Land Elevation Value
Land Marks
River & Lake)
Back
Next

(Page 3/4)
[Marine Settings]
(Name Tags
Tides and Currents
Place Name
Seabed Type
Port & Searvice
Attention Areas
Track & Routes
Under Water
[Light]
(Navigation Aids & Light Sector
Light Sectors Level))
Back
Next

(Page 4/4)
[Chart Settings]
(VAD (Value Added Data)
Chart Boundaries
[Combo box]Select boundaries)
[Under Water Settings]
(Wrecks Depth Label
Diffusers Depth Label
Obstructions Depth Label
Rocks Depth Label)
Graticule
Back

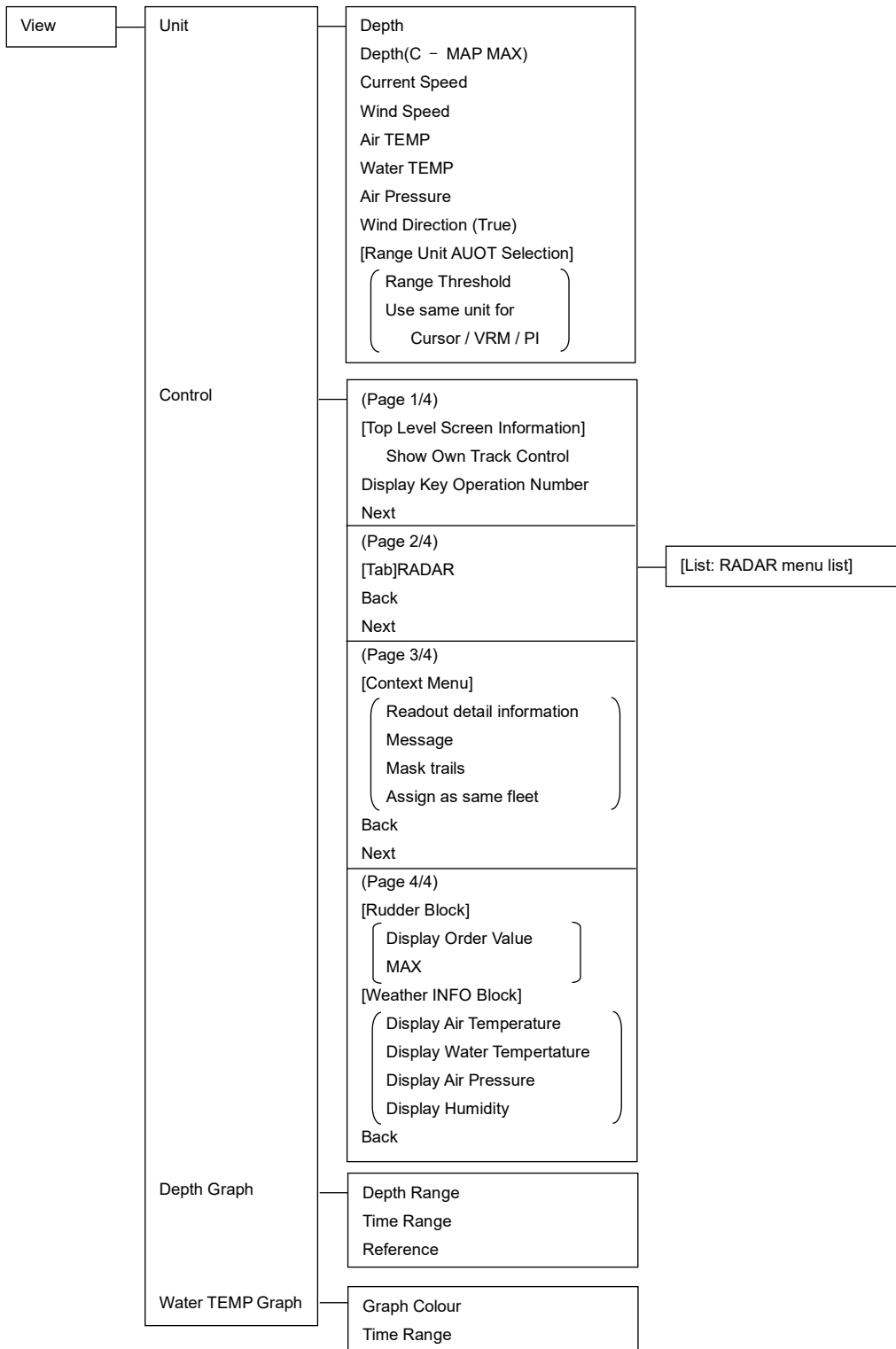

D.1.7 Alert

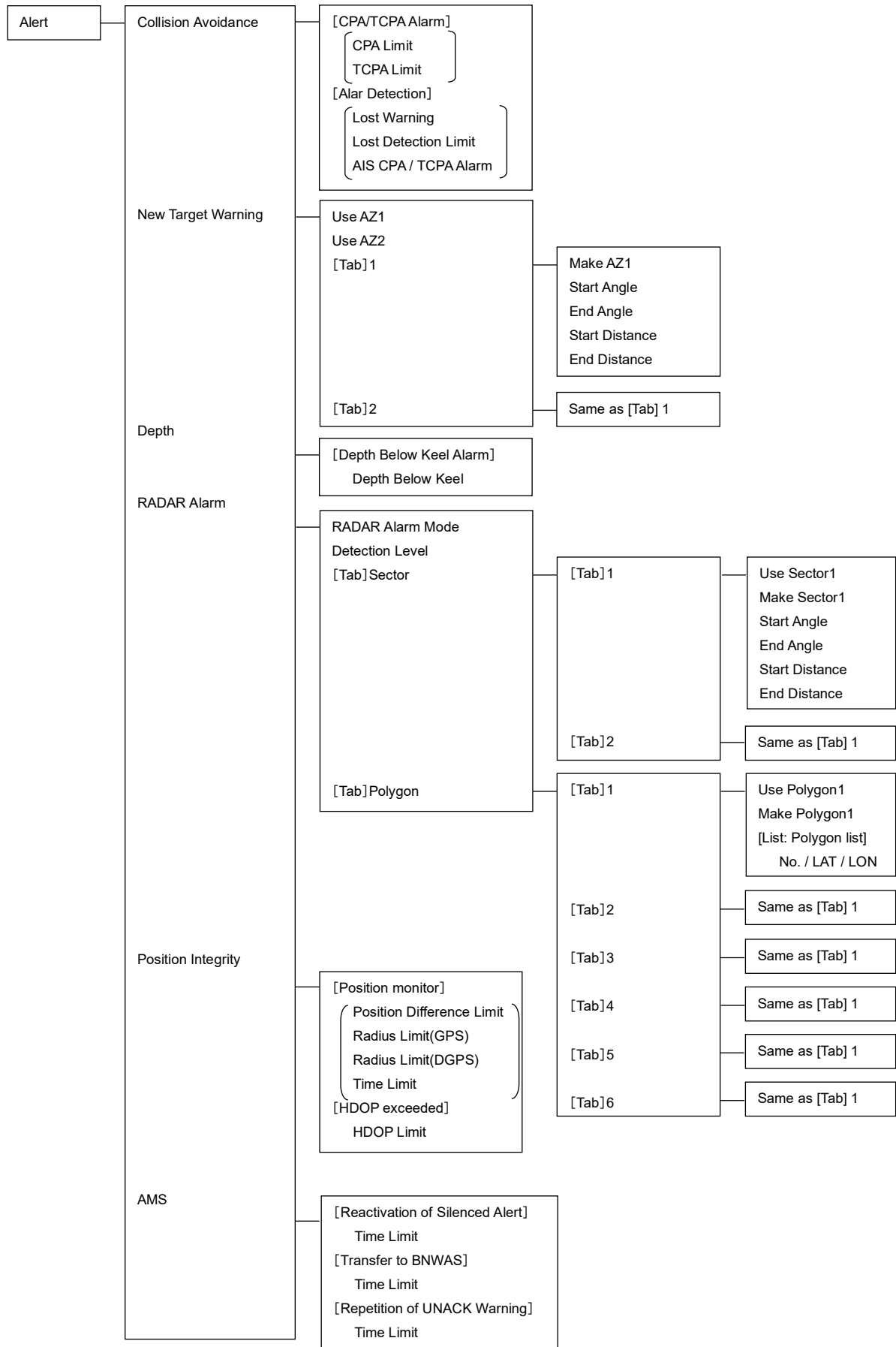

D.1.8 Settings

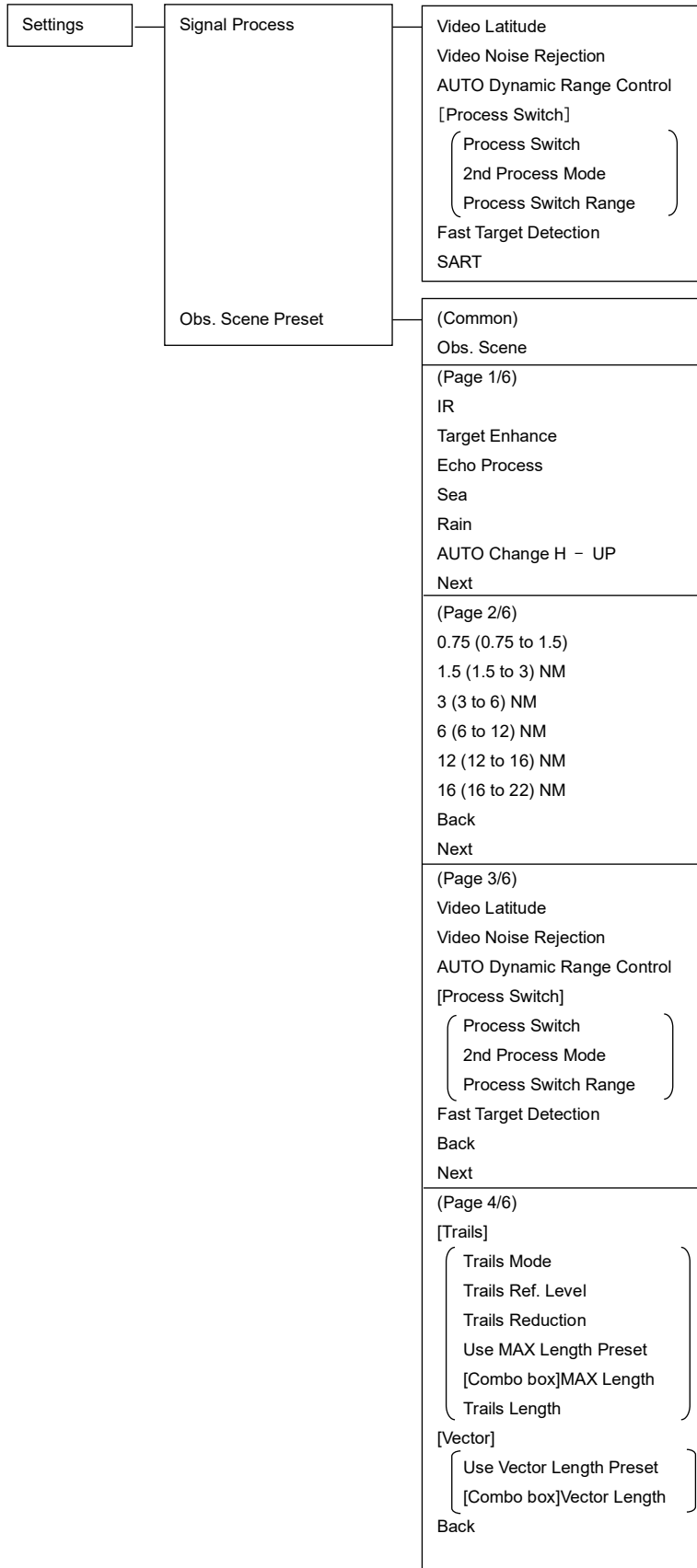

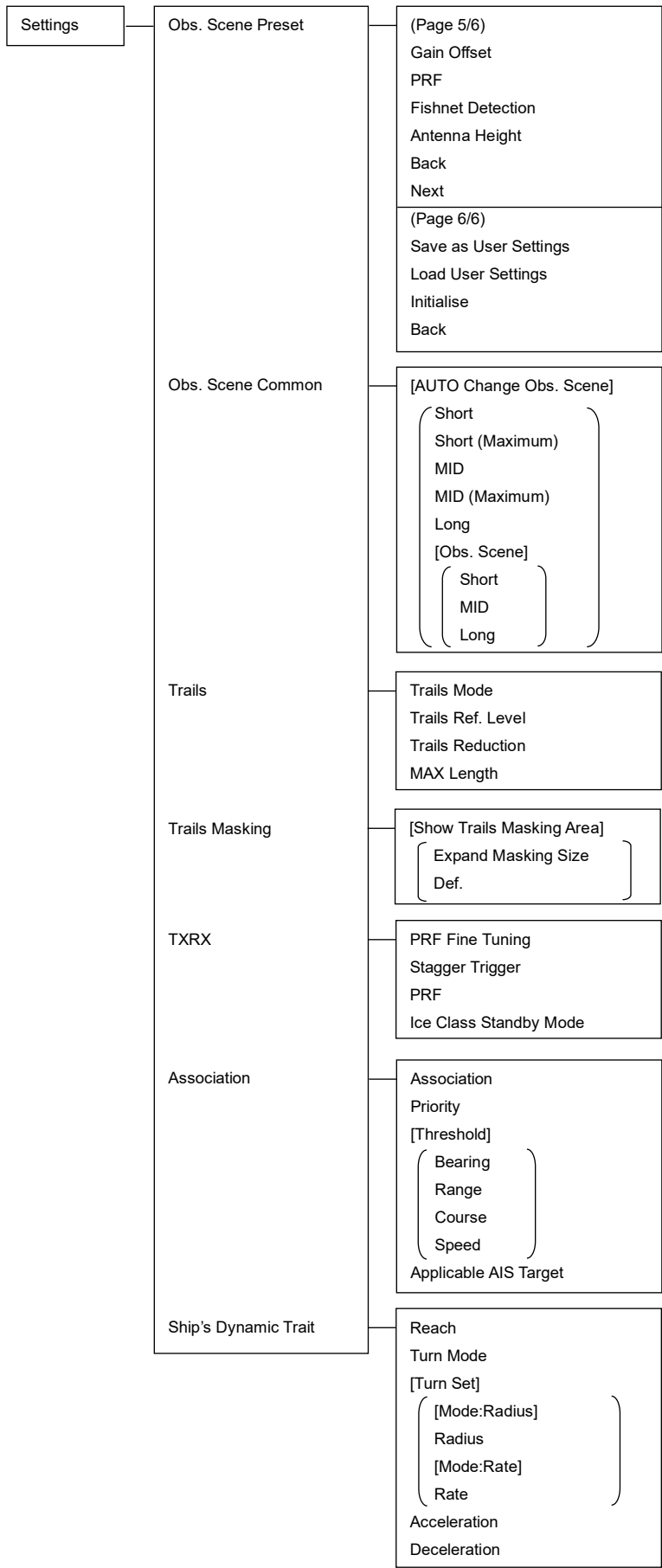

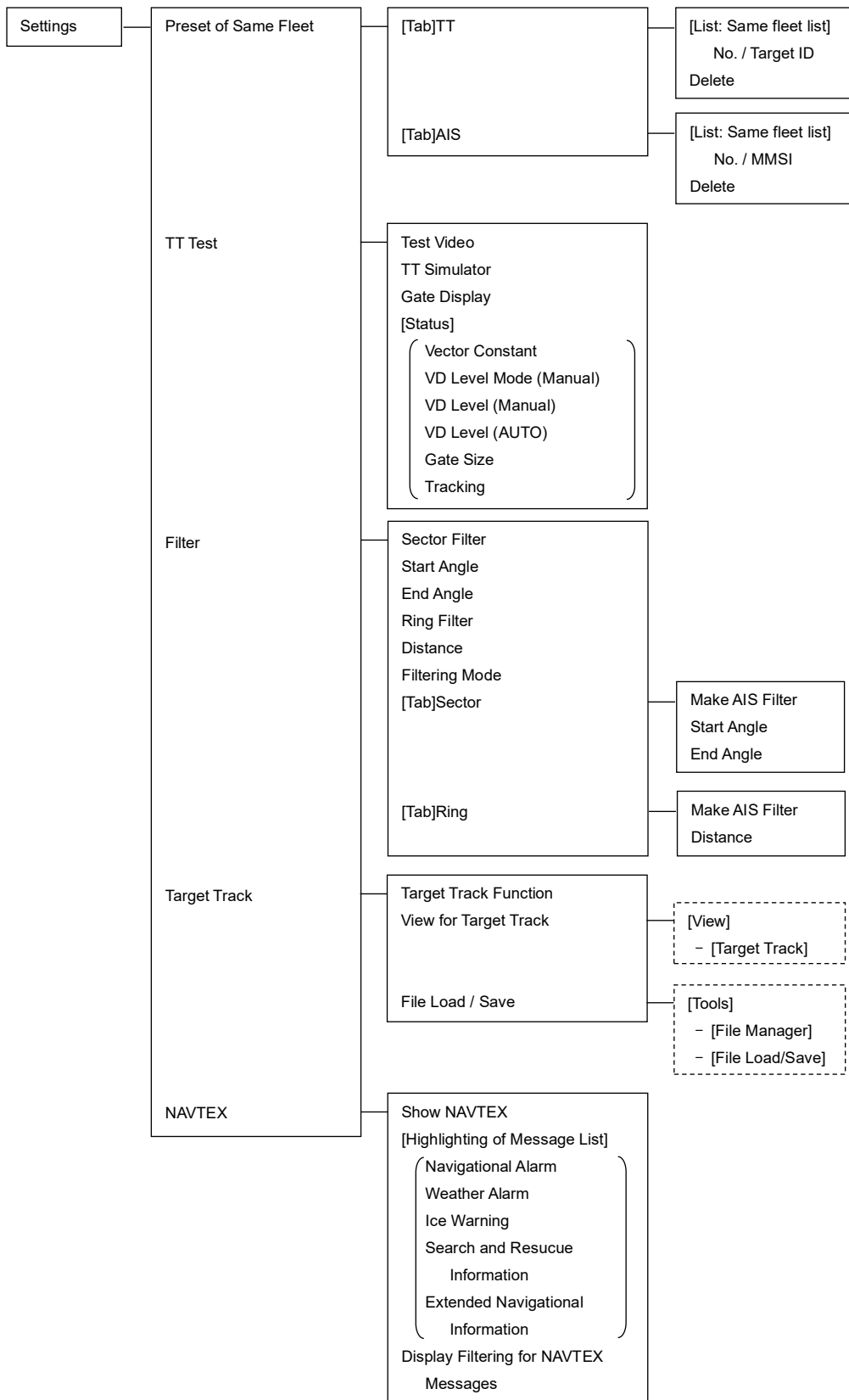

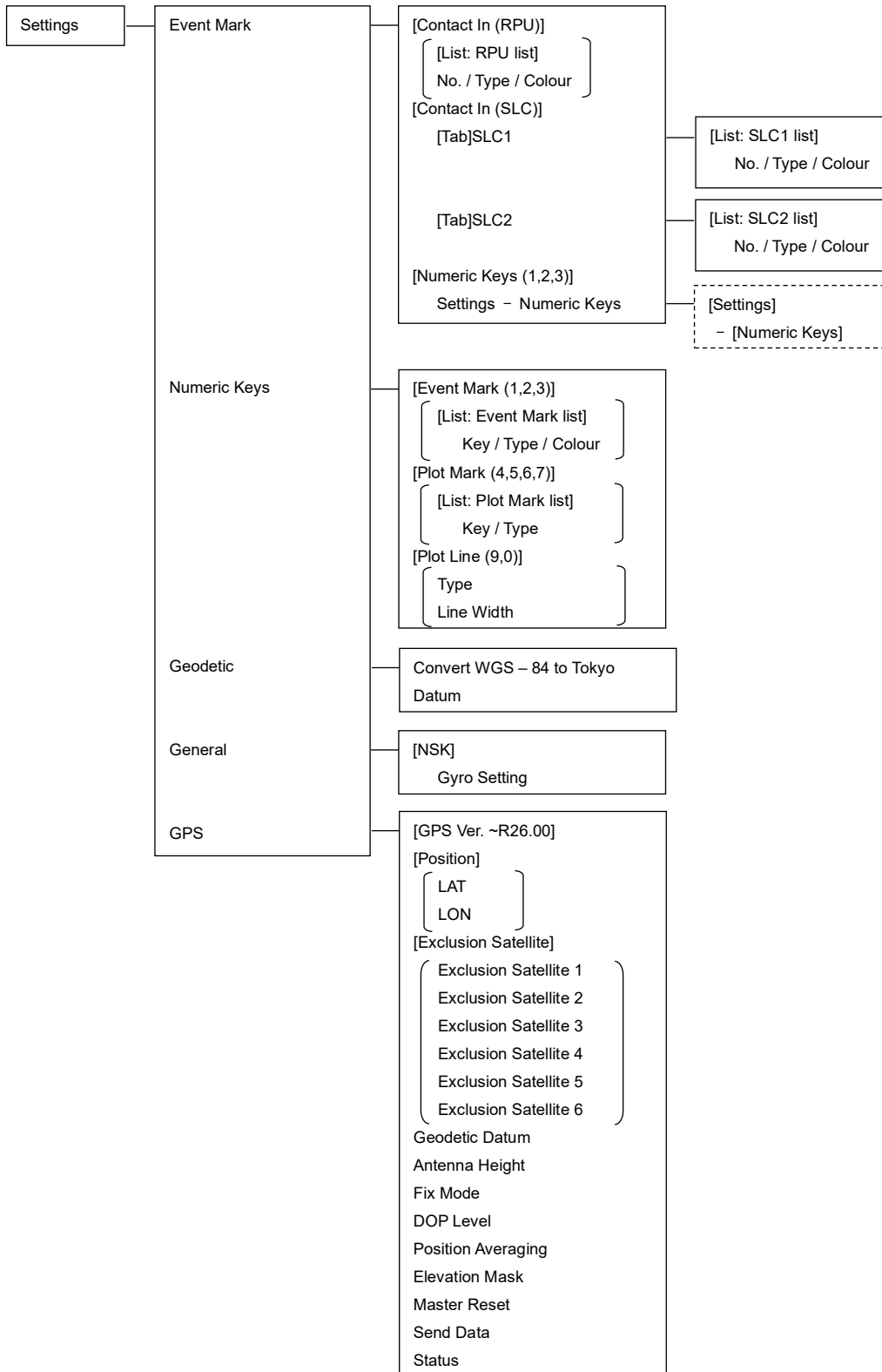

Settings

GPS

| |
|--|
| <p>[GPS Ver. R26.01~R30.99]</p> <p>[Position]</p> <p>[LAT] [LON]</p> <p>[Exclusion Satellite]</p> <p>[Exclusion Satellite 1] [Exclusion Satellite 2] [Exclusion Satellite 3] [Exclusion Satellite 4] [Exclusion Satellite 5] [Exclusion Satellite 6]</p> <p>Geodetic Datum</p> <p>Antenna Height</p> <p>Fix Mode</p> <p>DOP Level</p> <p>Position Averaging</p> <p>Elevation Mask</p> <p>Master Reset</p> <p>Send Data</p> <p>Status</p> |
| <p>[GPS Ver. R31.00~R38.99]</p> <p>[Position]</p> <p>[LAT] [LON]</p> <p>Geodetic Datum</p> <p>Antenna Height</p> <p>Fix Mode</p> <p>DOP Level</p> <p>Position Averaging</p> <p>Elevation Mask</p> <p>Master Reset</p> <p>Send Data</p> <p>Status</p> |
| <p>[GPS Ver. R39.00~R39.99]</p> <p>[Position]</p> <p>[LAT] [LON]</p> <p>Geodetic Datum</p> <p>Antenna Height</p> <p>Fix Mode</p> <p>DOP Level</p> <p>Position Averaging</p> <p>Elevation Mask</p> <p>RAIM Level</p> <p>Master Reset</p> <p>Send Data</p> <p>Status</p> |

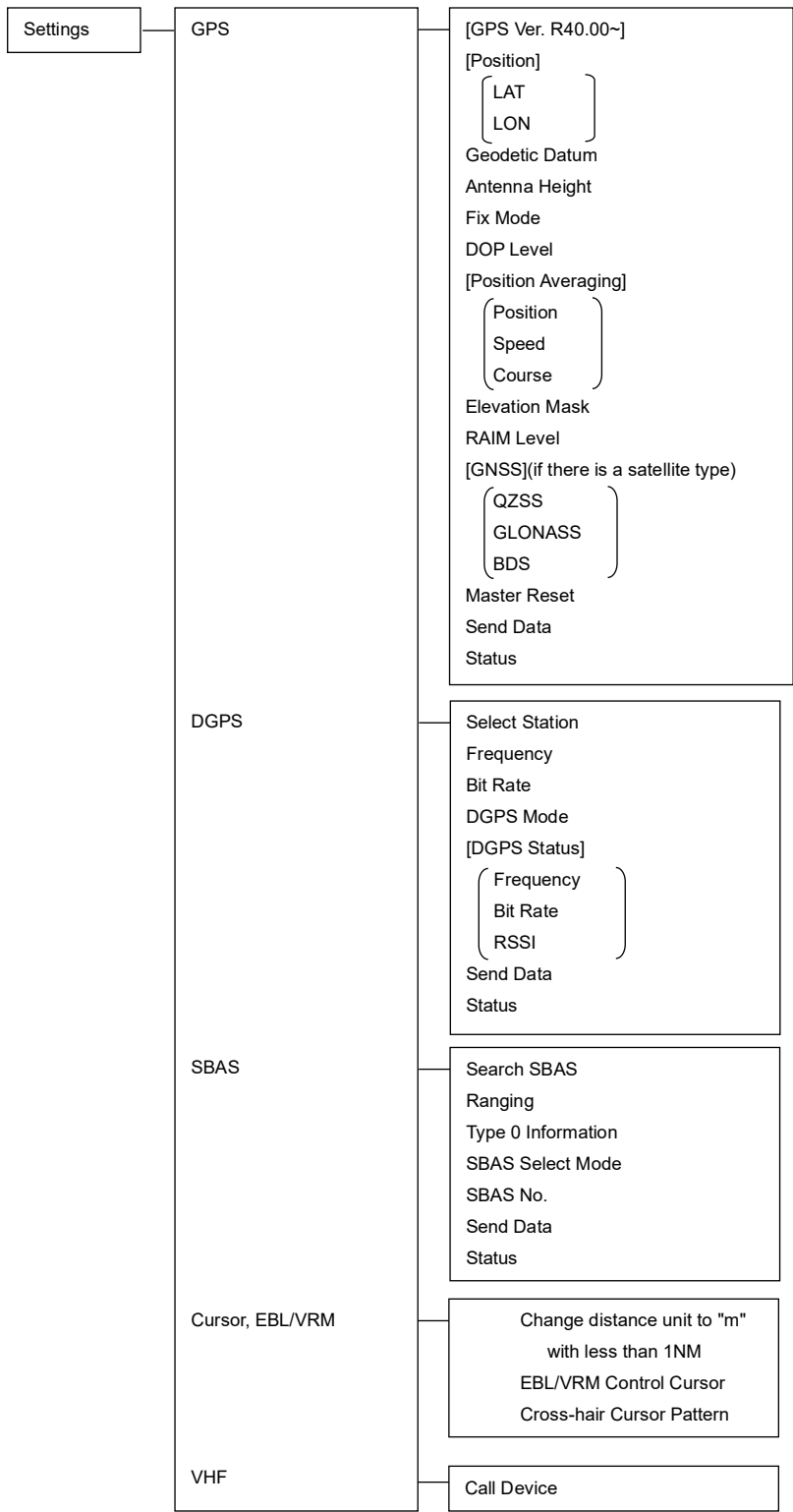

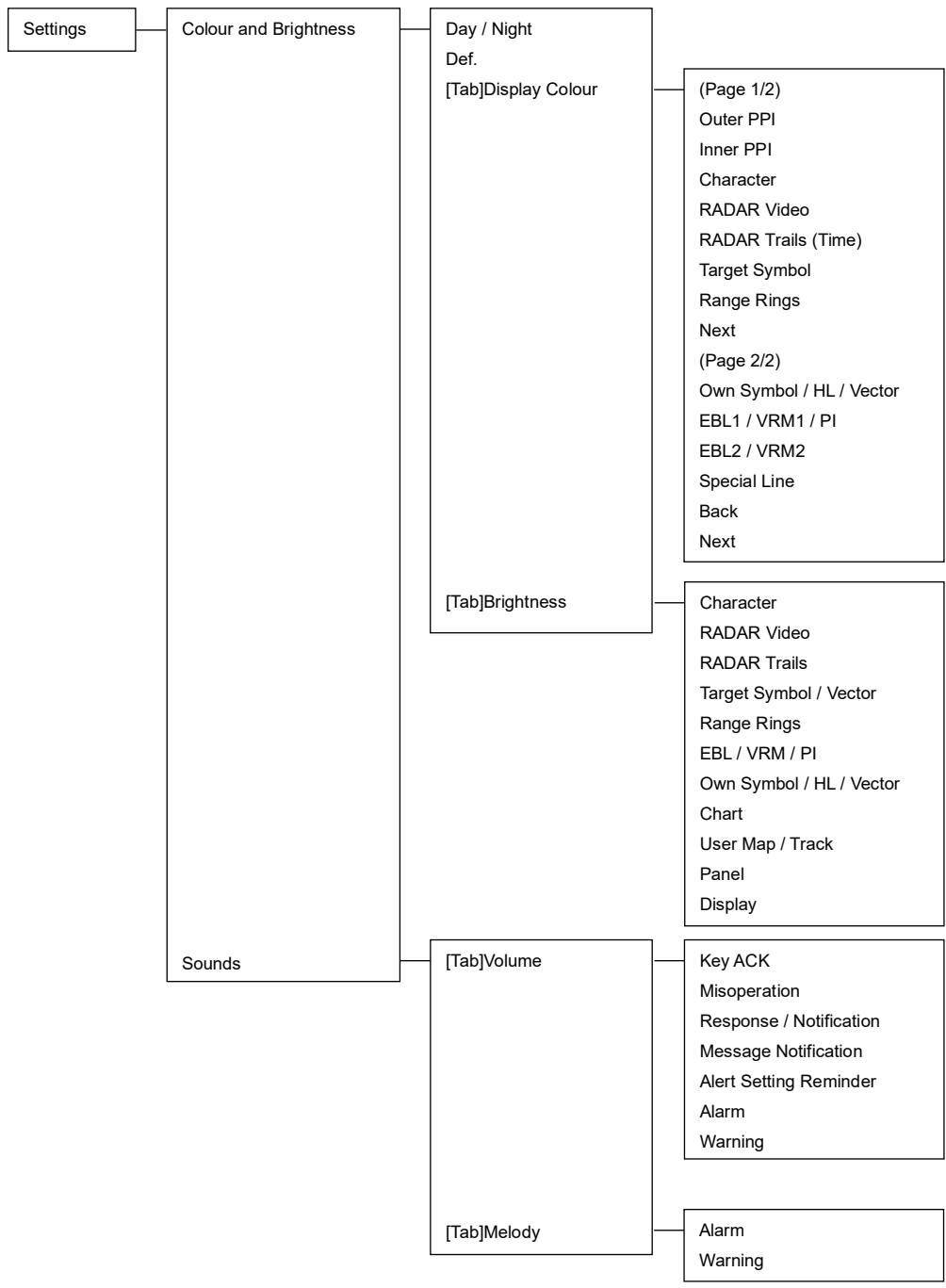

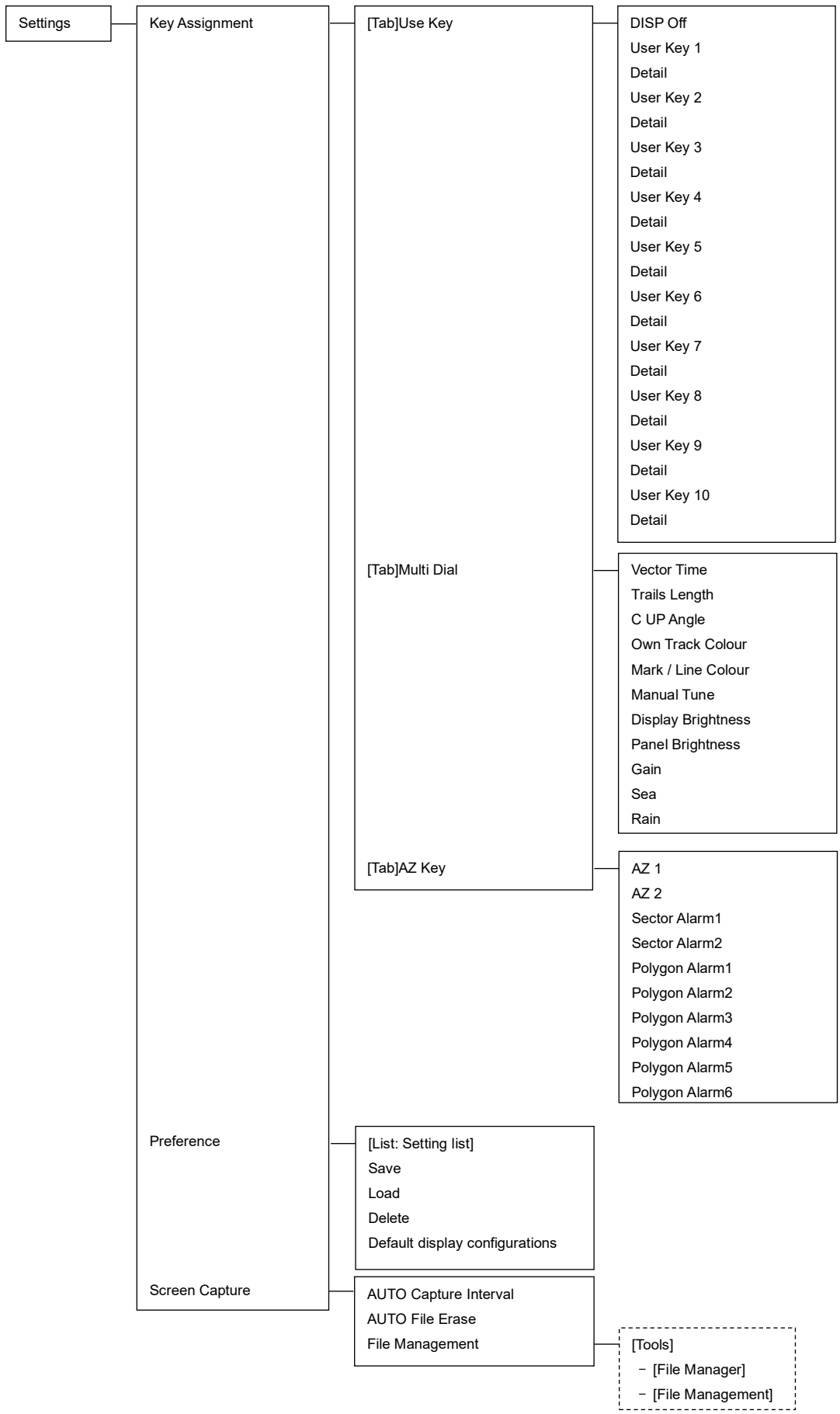

D.1.9 Maintenance

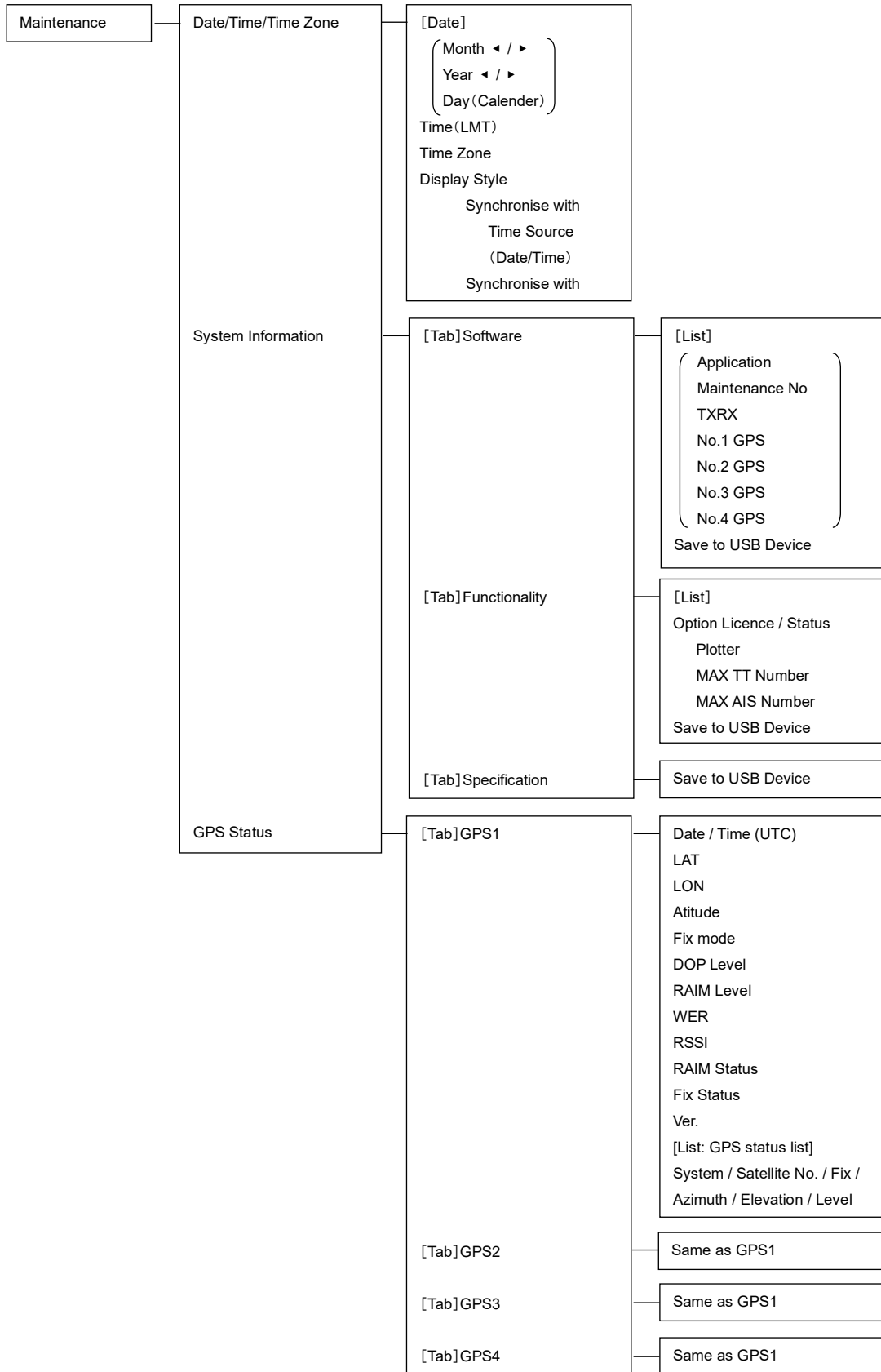

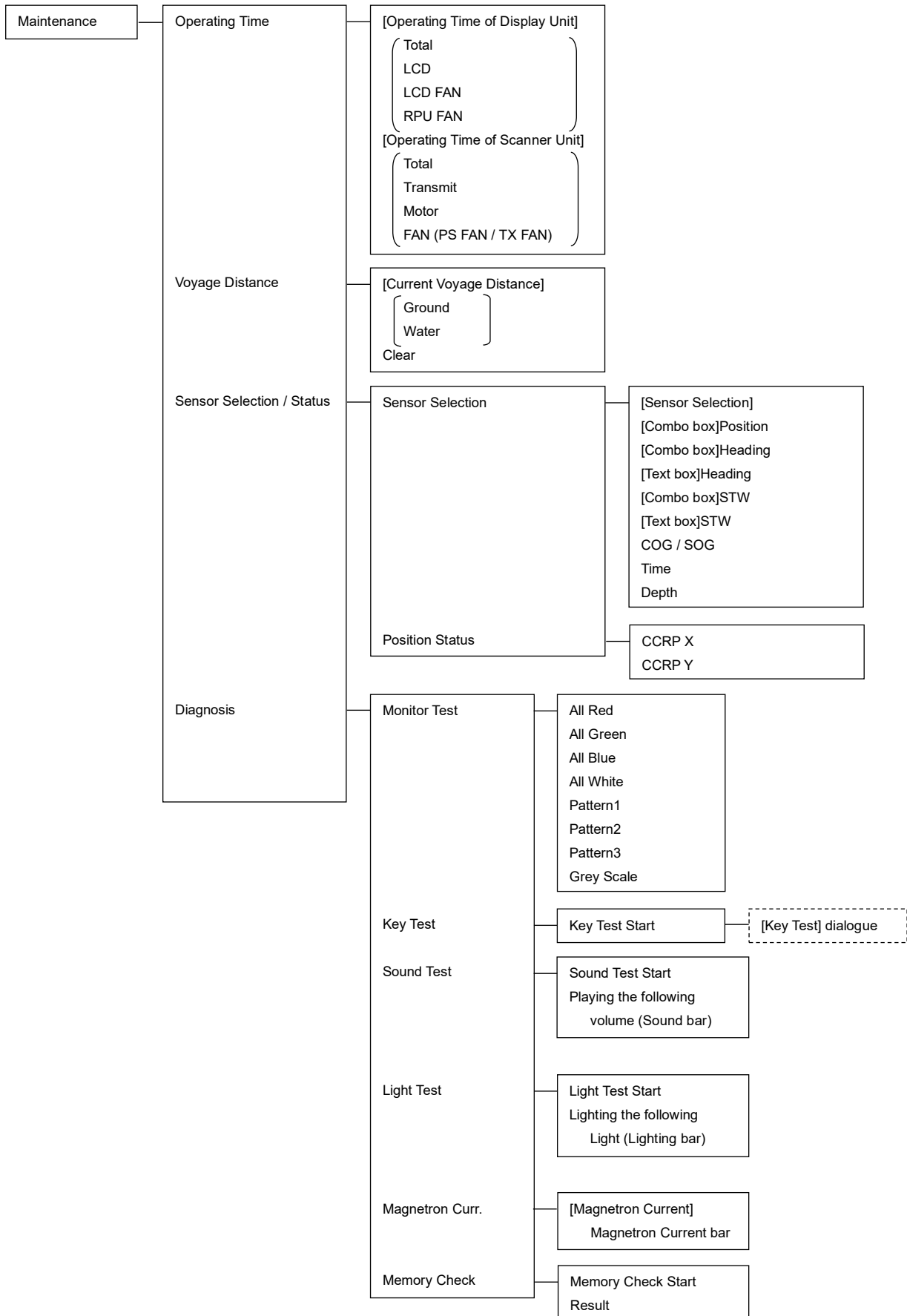

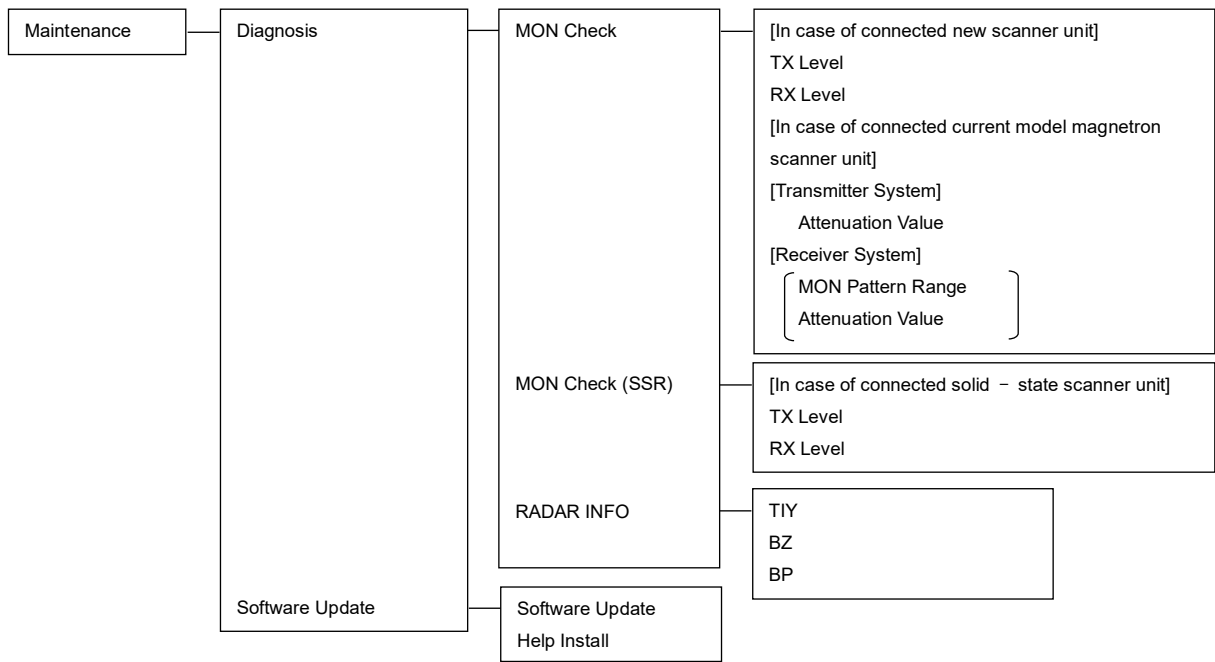

D.1.10 Help

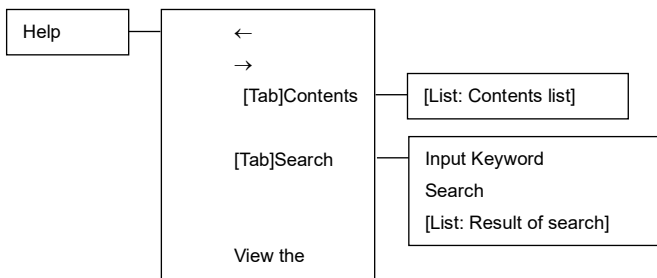

D.1.11 Code Input

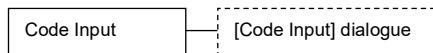

D.1.12 Service

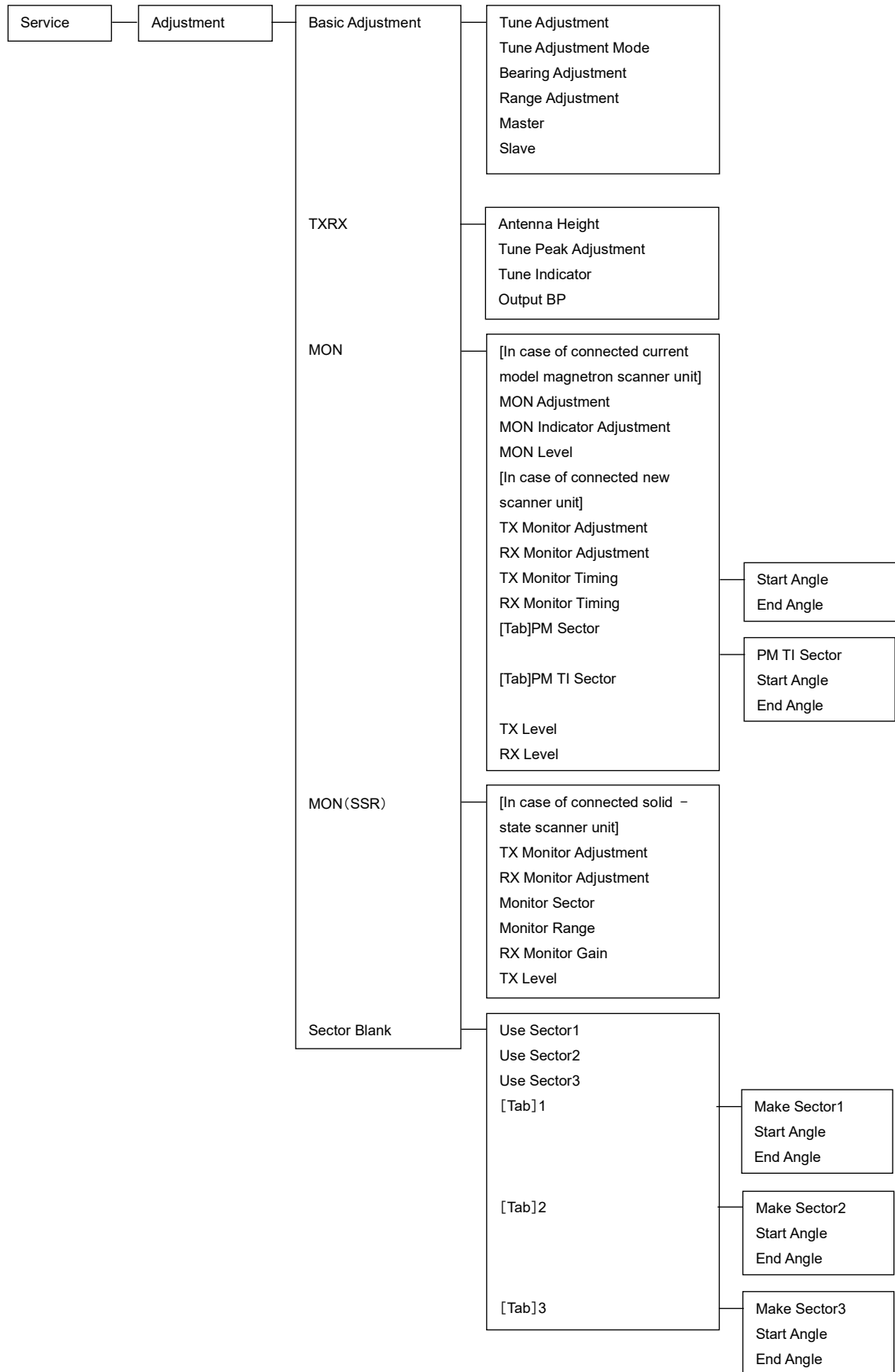

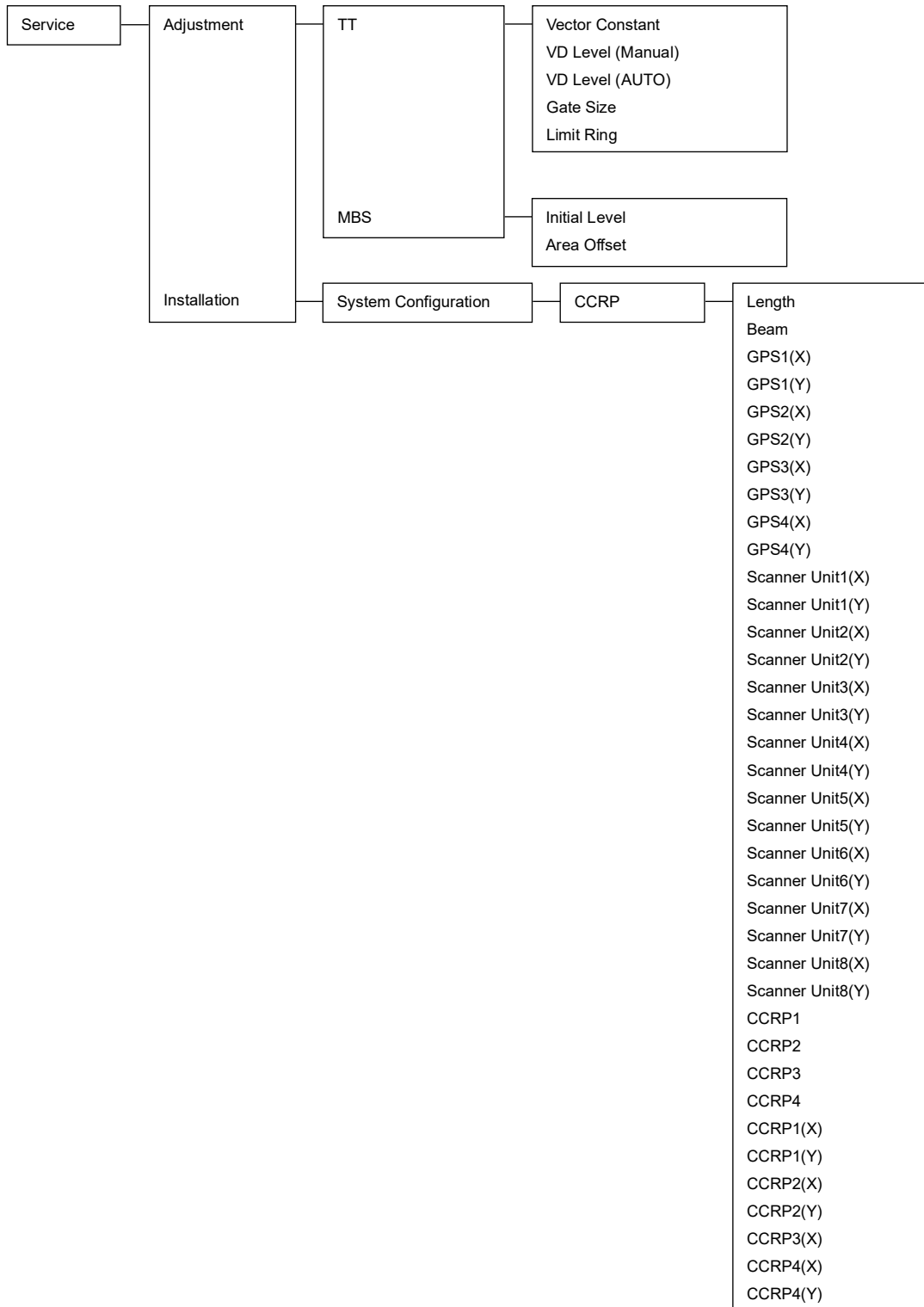

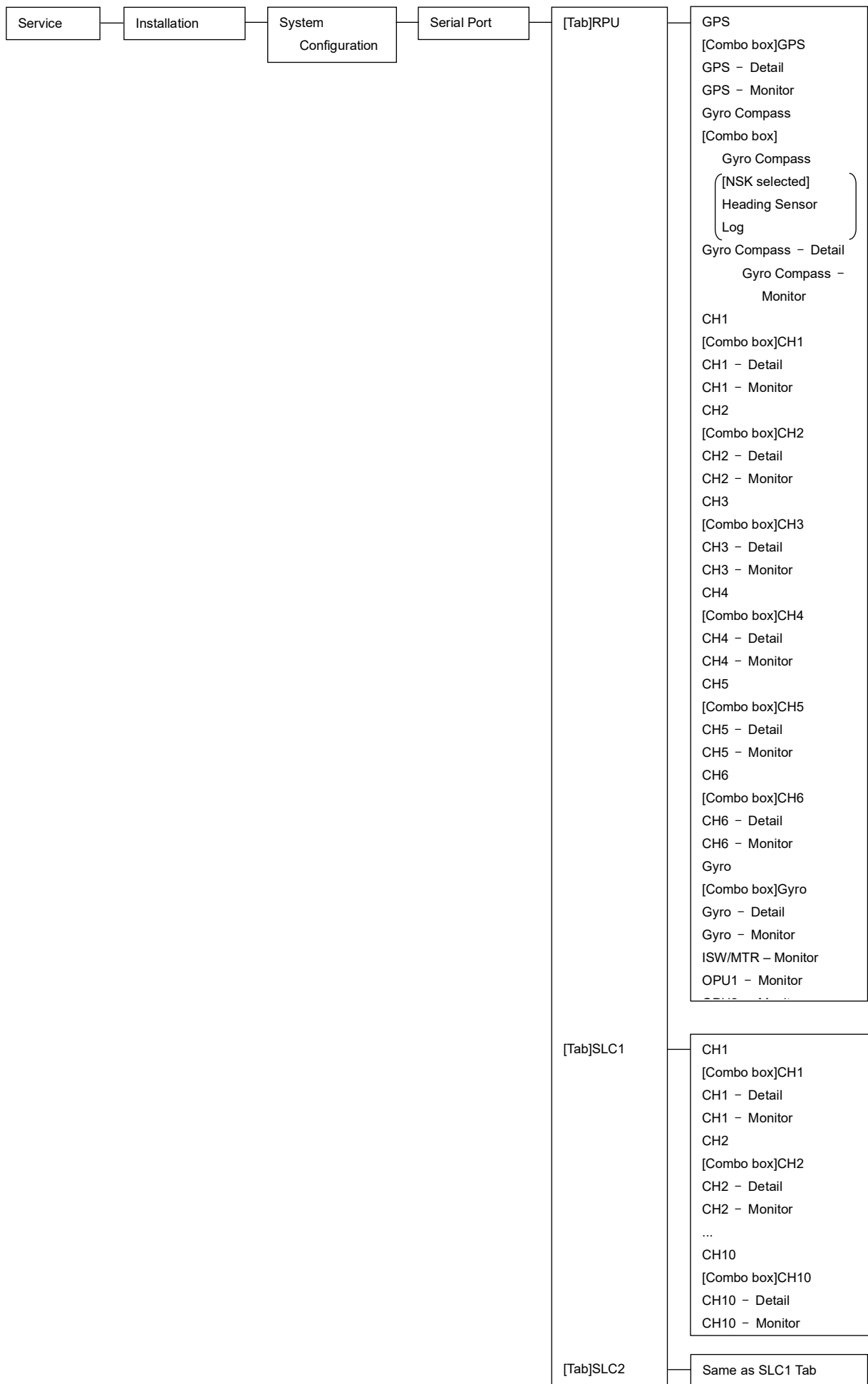

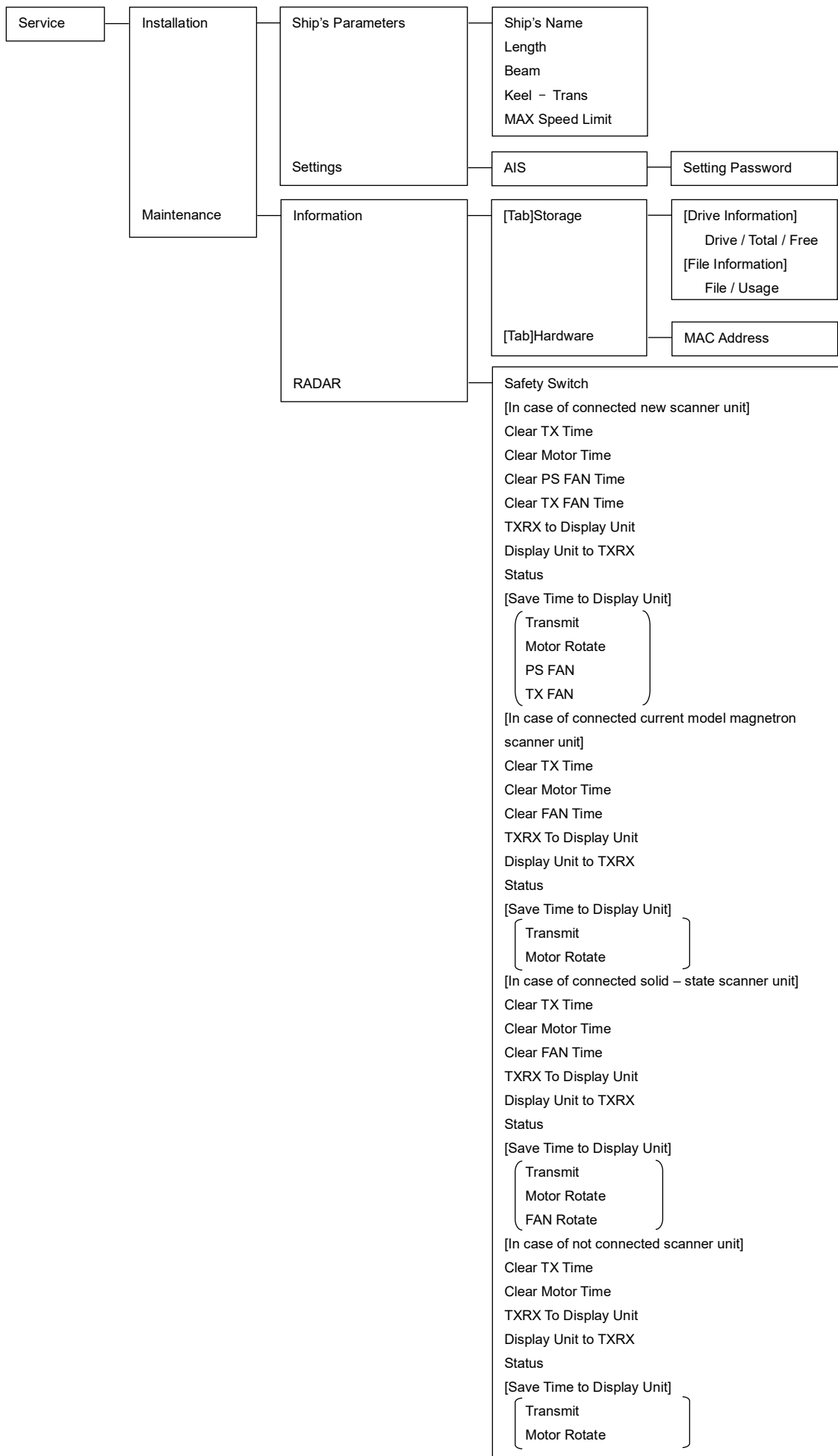

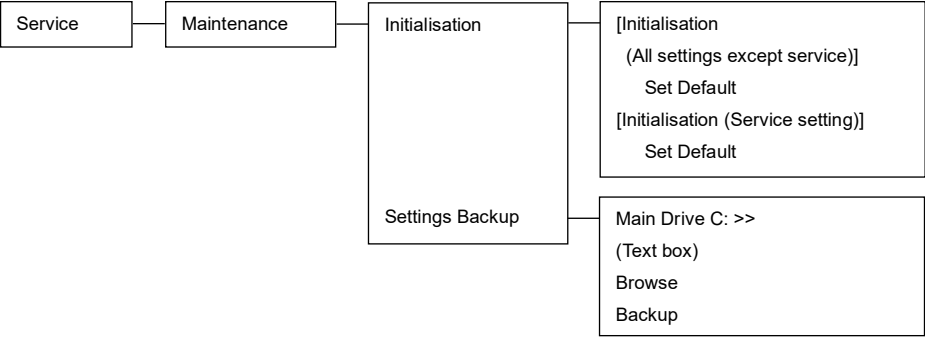

D.2 Context Menu List

This section shows the context menus that are displayed by clicking the right button by target object.

D.2.1 No object

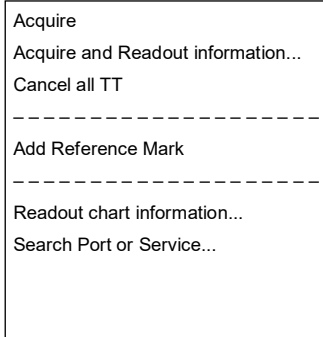

D.2.2 AIS

D.2.2.1 Sleeping AIS target

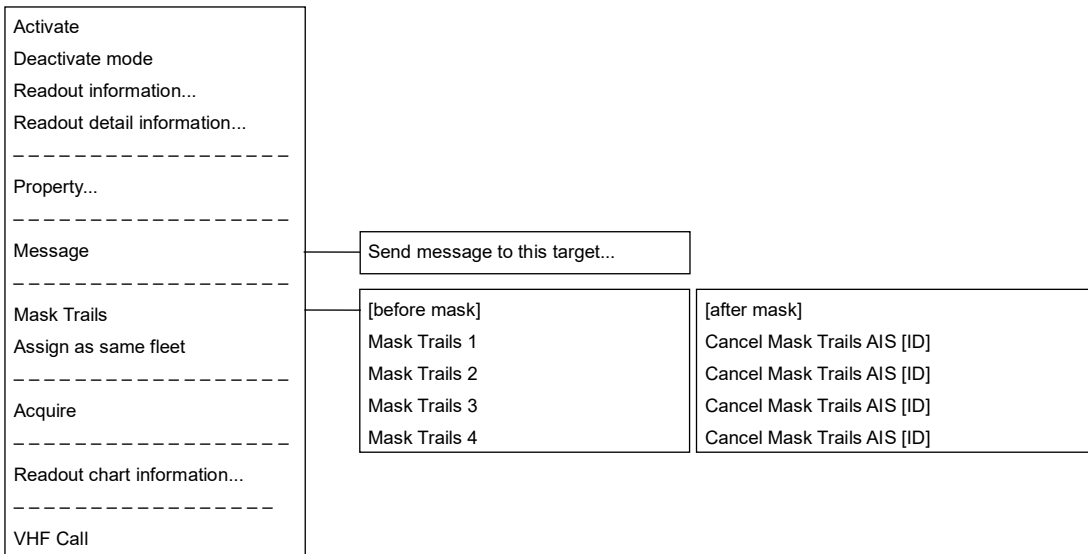

D.2.2.2 Activated AIS target

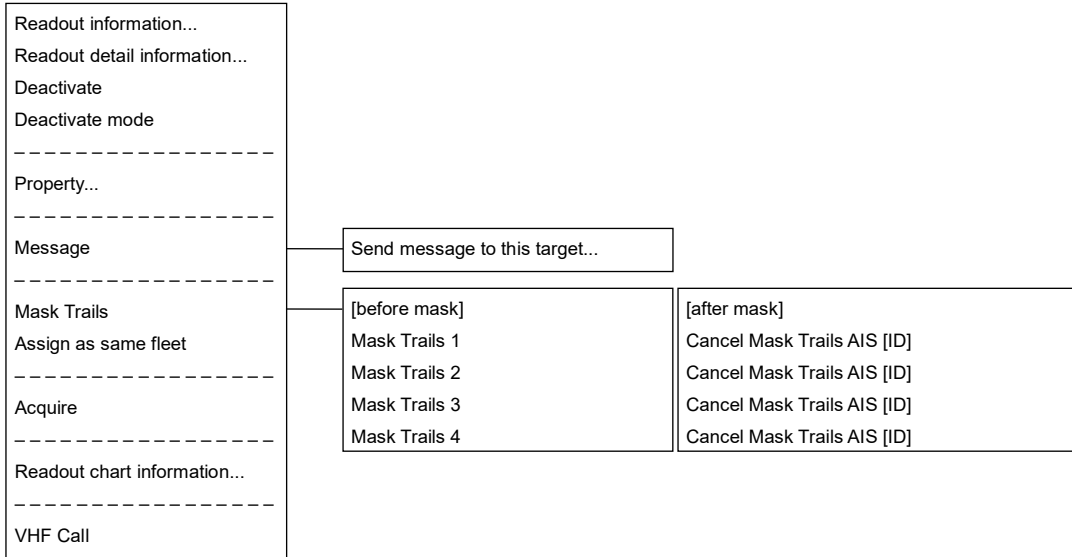

D.2.2.3 Numeric displayed AIS target

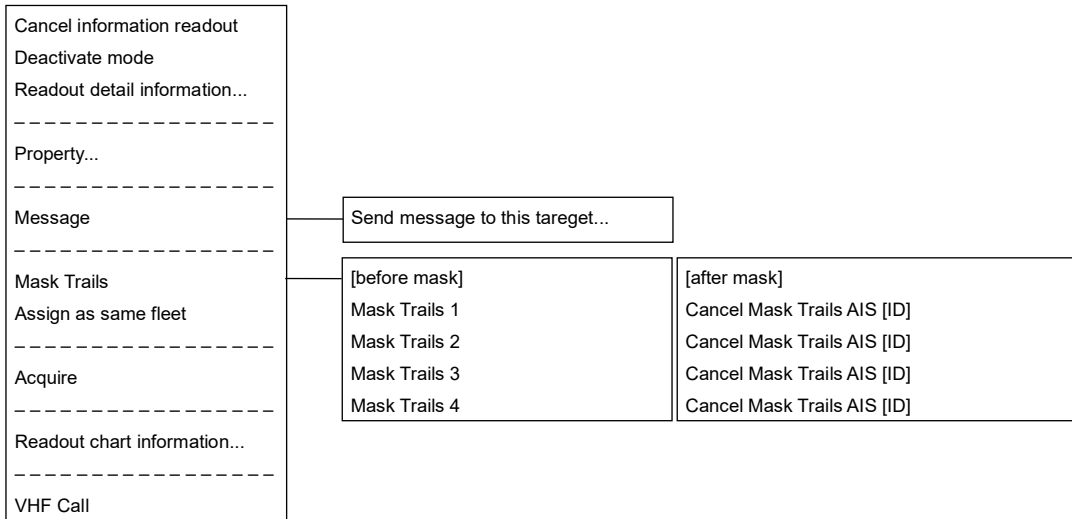

D.2.2.4 Normal AIS-SAR aircraft target

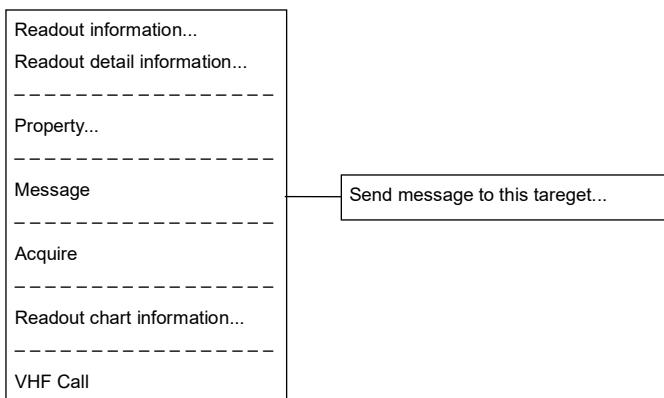

D.2.2.5 Numeric displayed AIS-SAR aircraft target

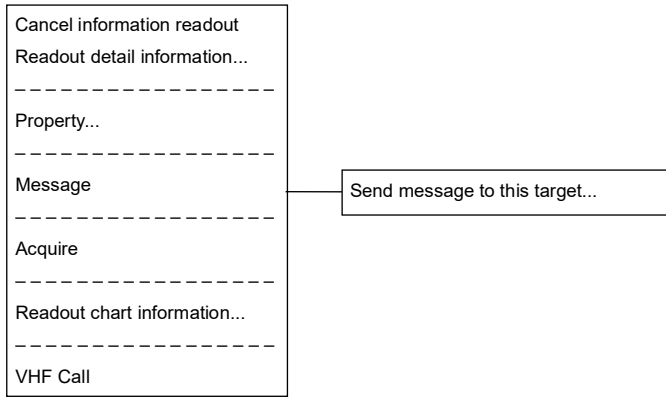

D.2.2.6 Sleeping AIS-SAR ship target

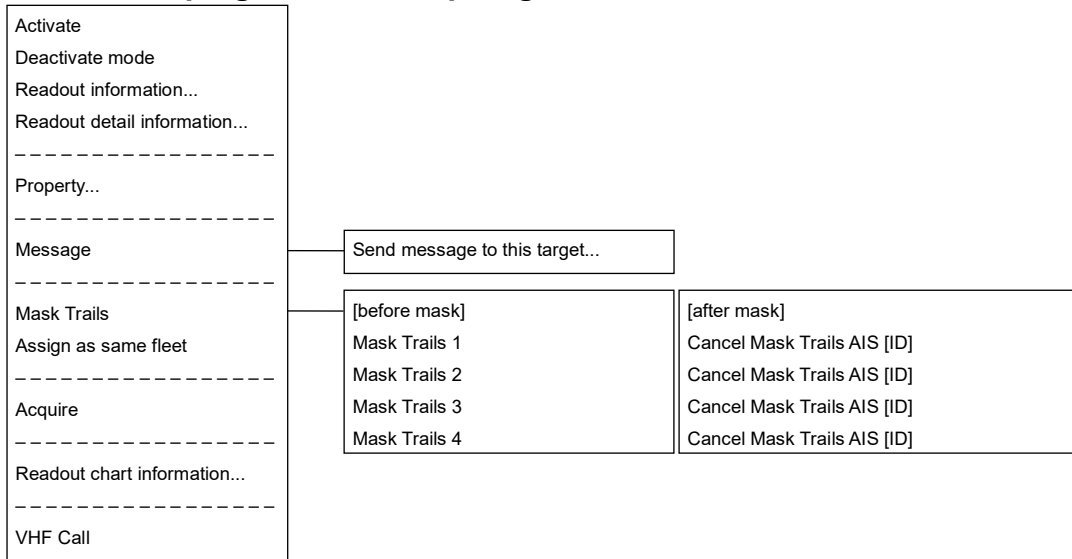

D.2.2.7 Activated AIS-SAR ship target

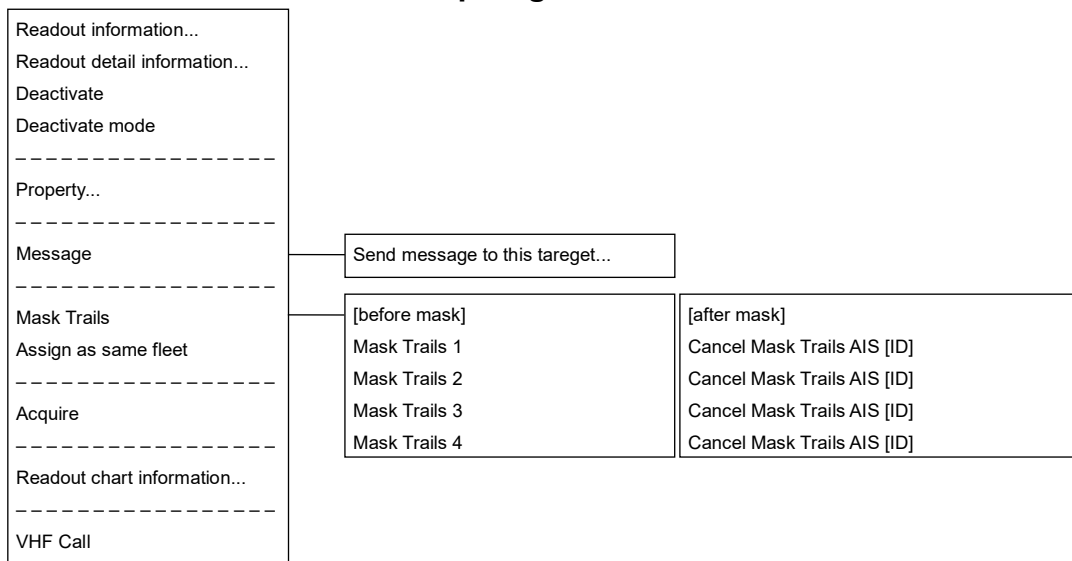

D.2.2.8 Numeric displayed AIS-SAR ship target

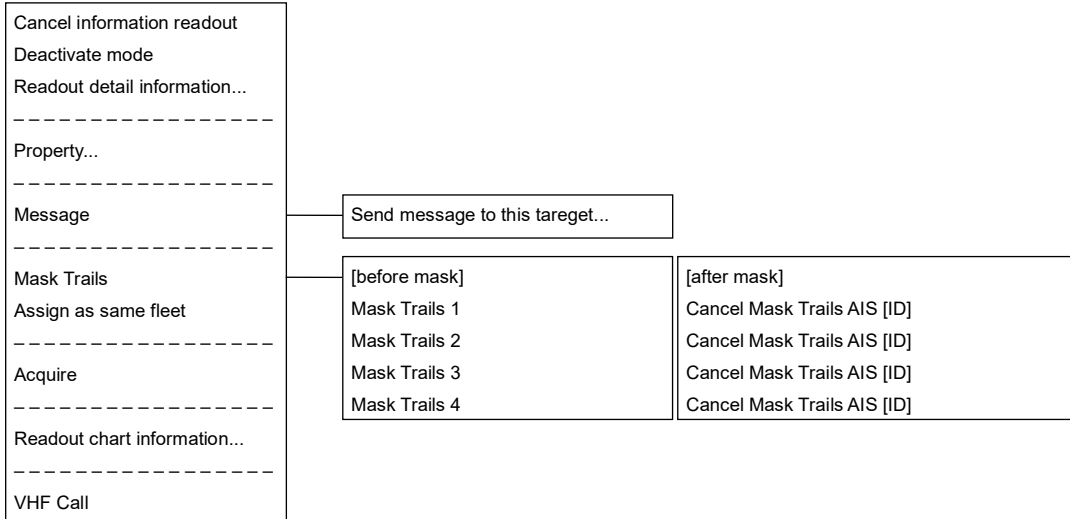

D.2.2.9 Sleeping AIS-SART target

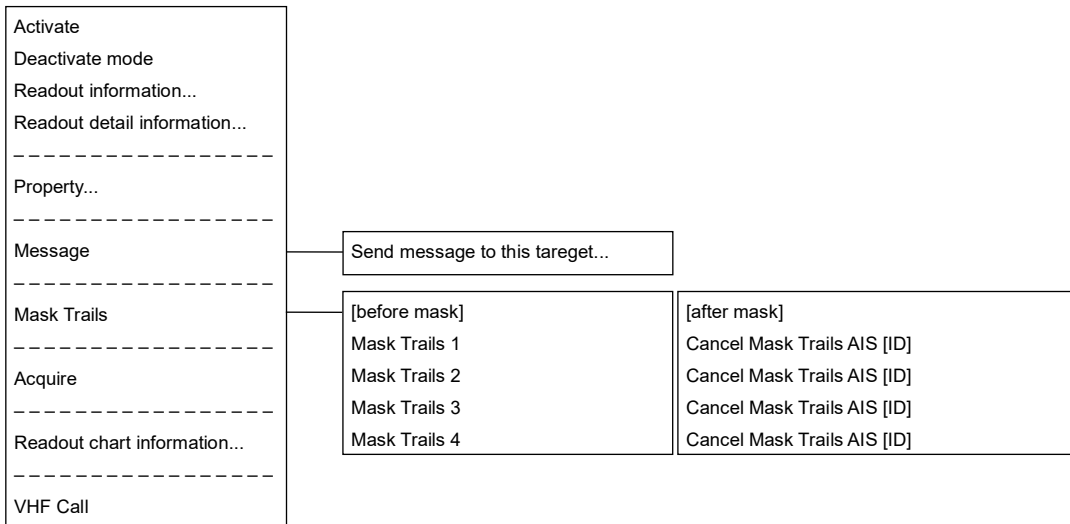

D.2.2.10 Activated AIS-SART target

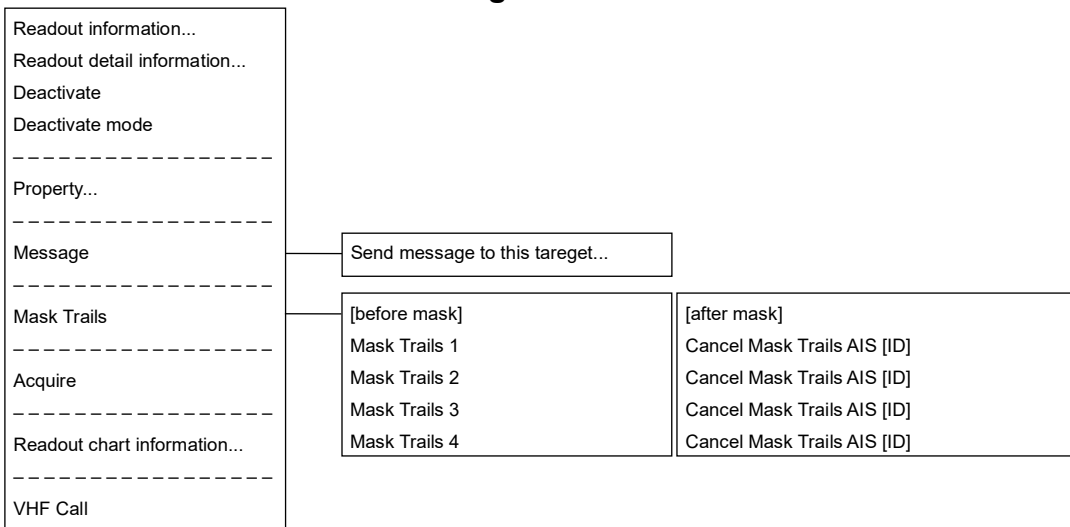

D.2.2.11 Numeric displayed AIS-SART target

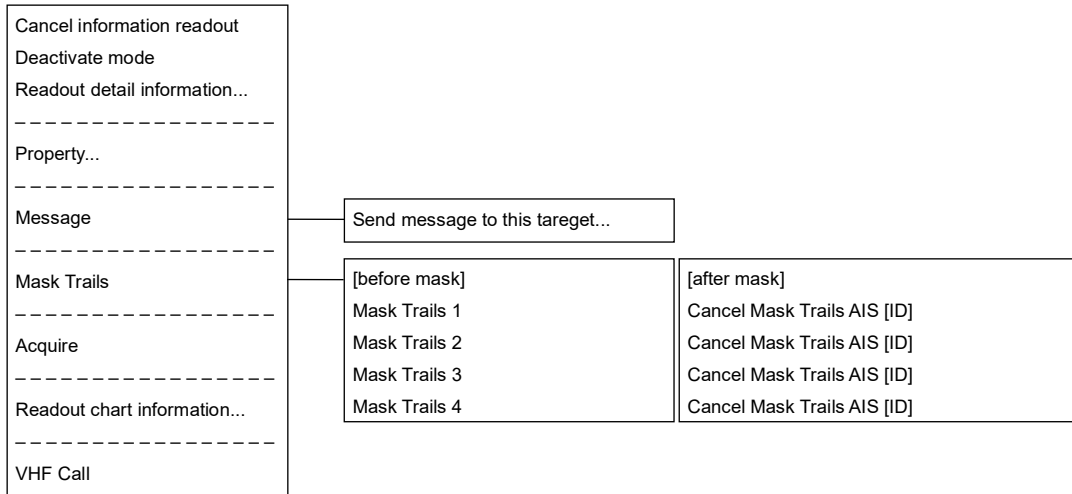

D.2.2.12 Normal AIS-AtoN target

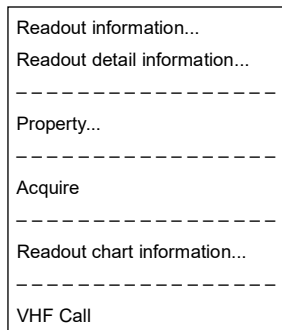

D.2.2.13 Numeric displayed AIS-AtoN target

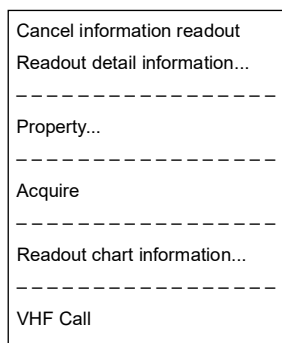

D.2.2.14 Normal AIS-BS target

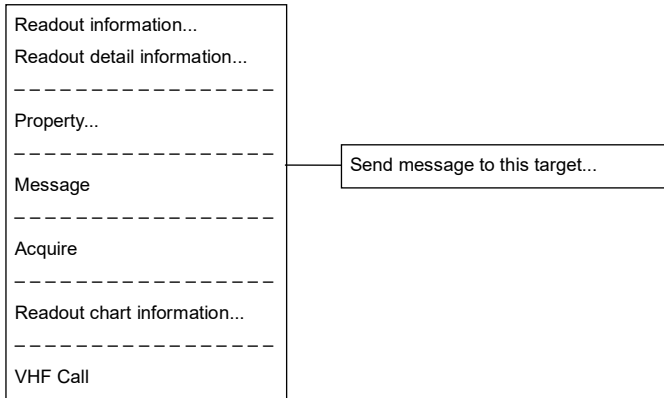

D.2.2.15 Numeric displayed AIS-BS target

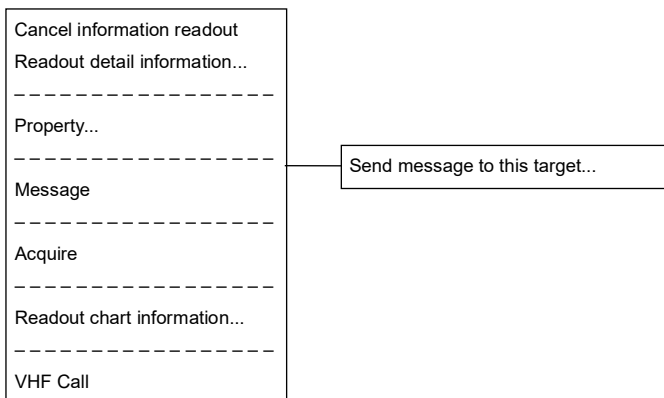

D.2.3 TT

D.2.3.1 Internal TT

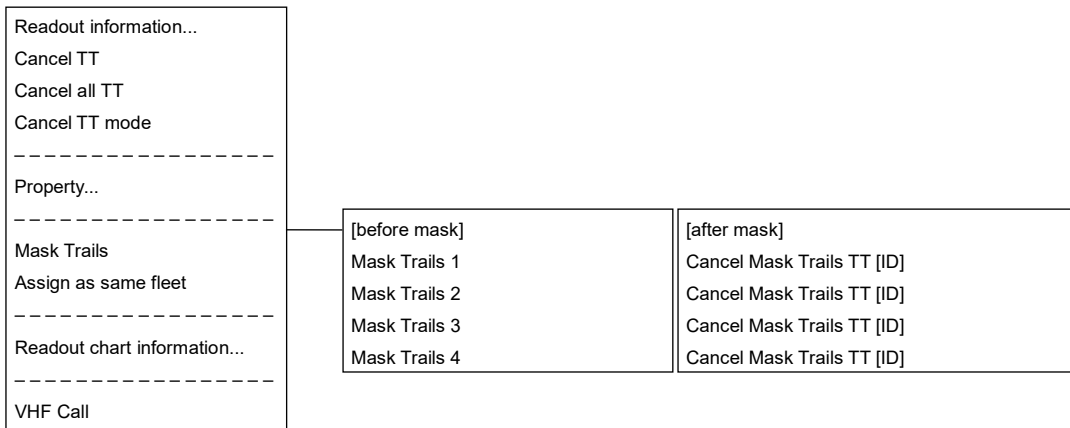

D.2.3.2 Internal TT - numeric display

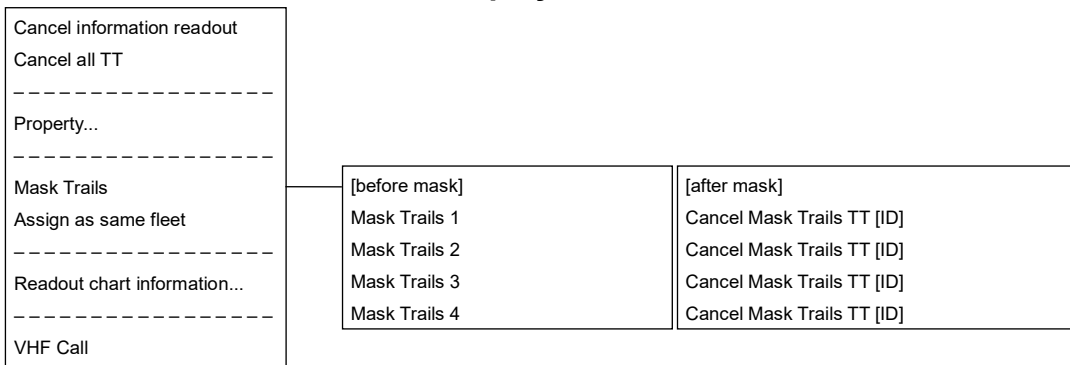

D.2.3.3 External TT

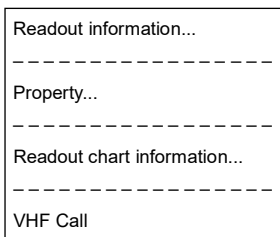

D.2.3.4 External TT - detail information display

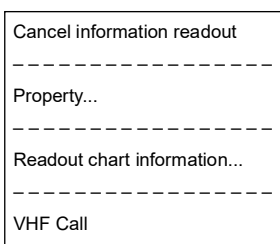

D.2.4 GPS Buoy

D.2.4.1 Normal GPS Buoy target

| |
|------------------------------|
| Cancel GPS Buoy... |
| Readout information... |
| ----- |
| Property... |
| ----- |
| Acquire |
| ----- |
| Readout chart information... |

D.2.4.2 Numeric displayed GPS Buoy target

| |
|------------------------------|
| Cancel GPS Buoy... |
| Cancel information readout |
| ----- |
| Property... |
| ----- |
| Acquire |
| ----- |
| Readout chart information... |

D.2.5 NAVTEX

D.2.5.1 NAVTEX

| |
|------------------------------|
| Readout NAVTEX information |
| ----- |
| Acquire |
| ----- |
| Readout chart information... |

D.2.6 User Map

D.2.6.1 Mark

| |
|------------------------------|
| Move this object |
| Delete this object |
| ----- |
| Show Mark/Line List... |
| ----- |
| Acquire |
| ----- |
| Readout chart information... |

D.2.6.2 Line (Start point·End point)

| |
|------------------------------|
| Add vartex |
| Move vartex |
| Delete vartex |
| ----- |
| Select All |
| Move this object |
| Delete this object |
| ----- |
| Show Mark/Line List |
| ----- |
| Acquire |
| ----- |
| Readout chart information... |

D.2.6.3 Line (Midpoint)

| |
|------------------------------|
| Move vartex |
| Delete vartex |
| ----- |
| Select All |
| Move this object |
| Delete this object |
| ----- |
| Show Mark/Line List |
| ----- |
| Acquire |
| ----- |
| Readout chart information... |

D.2.6.4 Line (Line segment)

| |
|------------------------------|
| Insert vartex |
| ----- |
| Select All |
| Move this object |
| Delete this object |
| ----- |
| Show Mark/Line List |
| ----- |
| Acquire |
| ----- |
| Readout chart information... |

D.2.6.5 Line (Select all)

| |
|------------------------------|
| Move this object |
| Delete this object |
| ----- |
| Show Mark/Line List |
| ----- |
| Acquire |
| ----- |
| Readout chart information... |

D.2.6.6 Text

| |
|------------------------------|
| Move this object |
| Delete this object |
| ----- |
| Show Mark/Line List |
| ----- |
| Acquire |
| ----- |
| Readout chart information... |

D.2.7 Monitoring dragging anchor

D.2.7.1 Dragging anchor monitoring circle (Circumference)

| |
|------------------------------|
| Move this object |
| Finish Anchor Watch |
| ----- |
| Acquire |
| ----- |
| Readout chart information... |

D.2.7.2 Dragging anchor monitoring circle (Square of the four corners)

| |
|------------------------------|
| Change radius |
| Move this object |
| Finish Anchor Watch |
| ----- |
| Acquire |
| ----- |
| Readout chart information... |

D.2.7.3 Dragging anchor monitoring polygon (Vertex)

| |
|--------------------|
| Delete vartex |
| Move this object |
| Delete this object |
| ----- |
| Acquire |

D.2.7.4 Dragging anchor monitoring polygon (Line segment)

| |
|--------------------|
| Insert vartex |
| Move this object |
| Delete this object |
| ----- |
| Acquire |

D.2.7.5 Dragging anchor monitoring polygon (Internal)

| |
|--------------------|
| Move this object |
| Delete this object |
| ----- |
| Acquire |

D.3 Abbreviations of Geodetic Data

| No | Geodetic Data | Display to the top screen | DTM sentence | |
|----|---------------------------------------|---------------------------|--------------|--------------------|
| | | | Abbreviation | User - defined No. |
| 0 | WGS 84 | WGS 84 | W84 | 0 |
| 1 | WGS 72 | WGS 74 | W74 | 1 |
| 2 | Tokyo | TOY | TOY | 2 |
| 3 | North American 1927 (USA) | NAS | NAS (*2) | 3 |
| 4 | North American 1927 (Canada & Alaska) | NAS | NAS (*2) | 4 |
| 5 | European 1950 | EUR | EUR | 5 |
| 6 | Australian Geodetic 1966 | AUA | AUA | 6 |
| 7 | Ordnance Survey of Great Britain | OGB | OGB | 7 |
| 8 | North American 1983 | NAR | NAR | 8 |
| 9 | No Use | Blank display | – | 9 |
| 10 | No Use | Blank display | – | 10 |
| 11 | Adindan | ADI | ADI | 11 |
| 12 | Arc 1950 | ARF | ARF | 12 |
| 13 | Australian Geodetic 1984 | AUG | AUG | 13 |
| 14 | Bermuda 1957 | BER | BER | 14 |
| 15 | Bogota Observatory | BOO | BOO | 15 |
| 16 | Campo Inchauspe | CAI | CAI | 16 |
| 17 | Chatam Island Astro 1971 | CHI | CHI | 17 |
| 18 | Chua Astro | CHU | CHU | 18 |
| 19 | Corrego Alegre | COA | COA | 19 |
| 20 | Djakarta (Batavia) | BAT | BAT | 20 |
| 21 | European 1979 | EUS | EUS | 21 |
| 22 | Geodetic Datum 1949 | GEO | GEO | 22 |
| 23 | Guam 1963 | GUA | GUA | 23 |
| 24 | Hayford 1910 | 024 | 024 (*1) | 24 |
| 25 | Hjorsey 1955 | HJO | HJO | 25 |
| 26 | Indian | IND | IND | 26 |
| 27 | Ireland 1965 | IRL | IRL | 27 |
| 28 | Kertau 1948 | KEA | KEA | 28 |
| 29 | L. C. 5 Astro 1961 | LCF | LCF | 29 |
| 30 | Liberia 1964 | LIB | LIB | 30 |
| 31 | Luzon | LUZ | LUZ | 31 |
| 32 | Merchich | MER | MER | 32 |
| 33 | Minna | MIN | MIN | 33 |
| 34 | Nahrwan | NAH | NAH | 34 |
| 35 | Naparima, BWI | NAP | NAP | 35 |
| 36 | Old Egyptian 1907 | OEG | OEG | 36 |

| No | Geodetic Data | Display to the top screen | DTM sentence | |
|----|---------------------------------|---------------------------|--------------|--------------------|
| | | | Abbreviation | User - defined No. |
| 37 | Old Hawaiian | OHA | OHA | 37 |
| 38 | Pico de las Nieves | PLN | PLN | 38 |
| 39 | Provisional South American 1956 | PRP | PRP | 39 |
| 40 | Provisional South Chilean 1963 | HIT | HIT | 40 |
| 41 | Puerto Rico | PUR | PUR | 41 |
| 42 | Qornoq | QUO | QUO | 42 |
| 43 | RT 90 | 043 | 043 (*1) | 43 |
| 44 | Sao Braz | SAO | SAO | 44 |
| 45 | South American 1969 | SAN | SAN | 45 |
| 46 | Graciosa Base SW 1948 | GRA | GRA | 46 |
| 47 | Timbalai 1948 | TIL | TIL | 47 |
| 48 | No Use | Blank display | – | 48 |
| 49 | No Use | Blank display | – | 49 |

D.4 Lists of Terminologies, Units, and Abbreviations

| Abbreviations | Term |
|---------------|--|
| A | |
| A/D = AD | Analogue/Digital |
| AC | Alternating Current |
| ACK | Acknowledge |
| ACQ | Acquire, Acquisition |
| ACT | Activate |
| AIO | Admiralty Information Overlay (additional information to the navigation) |
| AIS | Automatic Identification System |
| AMP | Amplifiers |
| AMS | Alert Management System |
| ANT | Antenna |
| ASCII | American Standard Code for Information Interchange |
| ASIC | Application Specific Integrated Circuit |
| AtoN | Aids to Navigation |
| AUTO = auto | Automatic |
| Av. = AVE | Average |
| AZ | Acquisition Zone |
| AZI | Azimuth Stabilisation Mode |
| B | |
| BAM | Bridge Alert Management |
| BCR | Bow Crossing Range |
| BCT | Bow Crossing Time |
| BFT | Beaufort |
| BNWAS | Bridge Navigational Watch Alarm System |
| BP | Bearing Pulse |
| BRG | Bearing |
| BZ | Bearing Zero |

| Abbreviations | Term |
|---------------|---|
| C | |
| C UP | Course Up |
| CA – CFAR | Cell Averaging CFAR |
| Cargo.Cat | Cargo Category |
| CCRP | Consistent Common Reference Point |
| CCRS | Consistent Common Reference System |
| CCW | Counterclockwise |
| CFAR | Constant False Alarm Rate |
| CH | Channel |
| CHG | Change |
| CID | Conning Information Display |
| CIF | Companion MPU Interface |
| CLR | Clear |
| COG | Course Over the Ground |
| COM | Communication Port |
| CONT | Contrast, Control |
| CONV | Conventional |
| CORREL | Correlation |
| CPA | Closest Point of Approach |
| CPU | Central Processing Unit |
| CTW | Course Through the Water |
| Curr. | Current |
| CW | Clockwise |
| D | |
| D/N | Day/Night |
| DC | Direct Current |
| Def. | Definition |
| DGPS | Differential GPS |
| DIFF | Difference |
| DIR = Dir. | Direction |
| DISP = Disp | Display |
| DIST | Distance |
| DSP | Digital Signal Processor |
| E | |
| EBL | Electronic Bearing Line |
| ECDIS | Electronic Chart Display and Information System |
| Ed. | Edition |
| EGC | Enhanced Group Calling |

| Abbreviations | Term |
|---------------|---|
| ENH | Enhance |
| EP | Estimated Position |
| EPA | Electronic Plotting Aids |
| EPFS | Electronic Position Fixing System |
| EQUIP | Equipment |
| ETA | Estimated Time of Arrival |
| F | |
| FPGA | Field Programmable Gate Array |
| FTC | Fast Time Constant |
| FWD | Forward |
| G | |
| GIF | Gyro Interface |
| GLONASS | Global Orbiting Navigation Satellite System |
| GND | Ground |
| GNSS | Global Navigation Satellite System |
| GPS | Global Positioning System |
| GZ | Guard Zone |
| H | |
| H UP | Head Up |
| H/W = HW | HardWare |
| HDG | Heading |
| HDOP | Horizontal Dilution of Precision |
| HL | Heading Line |
| HO | Hydrographic Organisation |
| HSC | High Speed Craft |
| I | |
| I/F = IF | Interface |
| I/O | Input/Output |
| IALA | International Association of Marine Aids to Navigation and Lighthouse Authorities |
| IALA – A | IALA – Region A |
| IALA – B | IALA – Region B |
| ID | Identification |
| IMO | International Maritime Organisation |
| IND | Indication |
| INFO | Information |
| INIT | Initialisation |

| Abbreviations | Term |
|---------------|--|
| INT | Interval |
| IP Address | Internet Protocol Address |
| IR | Interference Rejection |
| ISW | Interswitch |
| J | |
| K | |
| L | |
| L/L = LL | Latitude/Longitude |
| LAN | Local Area Network |
| LAT | Latitude |
| LCD | Liquid Crystal Display |
| LMT | Local Mean Time |
| LON | Longitude |
| LOP | Line of Position |
| LORAN | Long Range Navigation |
| LP | Long Pulse |
| M | |
| MAG | Magnetic |
| MAN | Manual |
| MAX | Maximum |
| MBS | Main Bang Suppression |
| MFDF | Medium Frequency Direction Finding |
| MHV | Modulator High Voltage |
| MIC | Microphone |
| MID | Middle |
| MIN | Minimum |
| MMSI | Maritime Mobile Services Identity Number |
| MOB | Man Overboard |
| MON | Monitor |
| MP | Medium Pulse |
| MSC | Maritime Safety Committee |
| MSG | Message |
| N | |
| N UP | North Up |
| NAV = NAVI | Navigation |
| NAVTEX | Navigational Telex |
| NE | North East |
| NFU | Non Follow Up |
| NLT | Not Less Than |
| NMEA | National Marine Electronics Association |

| Abbreviations | Term |
|---------------|-----------------------------------|
| NMEA0183 | NMEA 0183 standards |
| NMT | Not More Than |
| No. = NUM | Number |
| NSK | North Stabilisation Kit |
| NW | North West |
| O | |
| OPE | Operation |
| OPU | Operation Unit |
| OSD | Own Ship Data |
| OVRD | Override |
| P | |
| PI | Parallel Index Line |
| PIN | Personal Identification Number |
| PL | Pulse Length |
| PORT | Port/ Portside |
| POS = POSN | Position |
| PPI | Plan Position Indicator |
| PRF | Pulse Repetition Frequency |
| PROC | Process |
| PS | Power Supply |
| PWR | Power |
| Q | |
| R | |
| R | Relative |
| RADAR | Radio Detecting and Ranging |
| RAND | Random |
| REF | Reference |
| REL | Relative |
| Rev. | Revolution |
| RL | Rhumb Line |
| RM | Relative Motion |
| RM(R) | Relative Motion. Relative Trails. |
| RM(T) | Relative Motion. True Trails. |
| RMS | Root Mean Square |
| RNG | Range |
| RoRo | Roll On/ Roll Off (Vessel) |
| ROM | Read Only Memory |
| ROT | Rate of Turn |
| RPS | Route Planning System |
| RPU | RADAR Process Unit |
| RX | Receiver |

| Abbreviations | Term |
|---------------|--|
| S | |
| SA | Scheme Administrator |
| SAR | Search and Rescue |
| SART | Search and Rescue Transponder |
| SATNAV | Satellite Navigation |
| SBAS | Satellite Based Augmentation System |
| SDK | Software Development Kit |
| SE | South East |
| SEL | Select |
| Seq | Sequence |
| SFI | System Function ID |
| SLC | Serial LAN Interface Circuit |
| SOG | Speed Over the Ground |
| SP | Short Pulse |
| SPD | Speed |
| SprsLvl | Spurious Level |
| SSD | Solid State Drive |
| SSR | Solid State RADAR |
| SSW | Safety Switch |
| STAB | Stabilised, Stabilisation |
| STBD | Starboard, Starboard Side |
| STC | Sensitivity Time Control |
| STD | Standard |
| STW | Speed Through the Water |
| SW HUB | Switching Hub |
| SYNC | Synchronization |
| SYS | System |
| T | |
| T | True |
| T & P | Temporary and Preliminary Notice to Mariners |
| TCPA | Time to CPA |
| TD | Time Difference |
| TEMP = Temp. | Temperature |
| TGT | Target |
| TM | True Motion |
| TNI | Tune Indicator |
| TPL | Transferred Line of Position |





























| Abbreviations | Term |
|---------------|---------------------------------|
| TRX | Transceiver |
| TT | Target Tracking |
| TTG | Time to Go |
| TX | Transmitter |
| TXRX | Transceiver |
| U | |
| U.Map | User Map |
| UNACK | Un – Acknowledge |
| Up.No. | Update Number |
| USB | Universal Serial Bus |
| UTC | Coordinated Universal Time |
| V | |
| VD | Video |
| VDIN | Video In |
| VDR | Voyage Data Recorder |
| Ver. | Version |
| VHF | Very High Frequency |
| VOL | Volume |
| VRM | Variable Range Marker |
| W | |
| WGS | World Geodetic System |
| WIG | Wing – in – ground effect craft |
| WOL | Wheel Over Line |
| WPT | Waypoint |
| WTRST | Watch Timer Reset |
| X | |
| XTD | Cross Track Distance |
| XTL | Cross Track Limit, Route Width |
| Y | |
| Z | |
| Unit | |
| bps | bit per second |
| cm | centimetre |
| dB | decibel |
| deg | degree |
| fm | fathom |
| ft | feet, foot |
| h = hr | hour |
| hPa | hecto pascal |
| Hz | hertz |

| Abbreviations | Term |
|---------------|------------------------|
| kg | kilogram |
| km | kilometre |
| kn = kts | knot |
| m | metre |
| mbar | millibar |
| min | minute |
| mph | mile per hour |
| NM | nautical mile |
| RAD | radius |
| rpm | revolutions per minute |
| s | second |
| sm | statute mile |



D.5 Icon Button List for User Map

The lists of icon buttons that are used for user map are provided below.

D.5.1 Mark

| Button name | Icon name | Icon display example | Icon name | Icon display example |
|---------------|-----------|---|-----------------------|---|
| [Mark] button | Circle1 |  | Buoy1 |  |
| | Triangle1 |  | Buoy2 |  |
| | Triangle2 |  | Buoy3 |  |
| | Square |  | Mark5 |  |
| | Diamond |  | Round |  |
| | Wreck |  | Triangle3 |  |
| | Mark1 |  | Dangerous |  |
| | Mark2 |  | Anchor |  |
| | Mark3 |  | Anchor Prohibited |  |
| | Mark4 |  | Circle2 |  |
| | Plus |  | Non - dangerous wreck |  |
| | Cross |  | Dot2 |  |
| | Y |  | Dot3 |  |
| | Drum |  | Dot1 |  |
| | Star |  | | |

D.5.2 Line

| Button name | Icon name | Icon display example |
|---------------|--------------------|---|
| [Line] button | Line (Solid Line) |  |
| | Line (Dotted Line) |  |
| | Line (Dashed Line) |  |









D.5.3 Text



| Button name | Icon name | Icon display example |
|---------------|-----------|---|
| [Text] button | Text |  |

D.6 List of Navigation - related Symbols

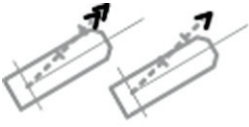

The navigation – related symbols that are displayed in this equipment are listed below.

D.6.1 Related to own ship symbols

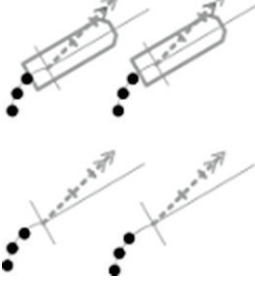
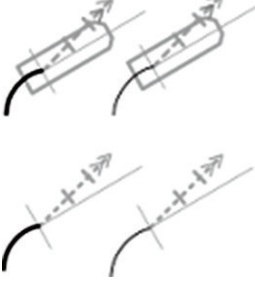
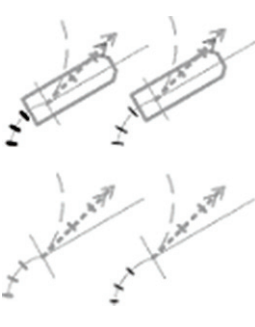
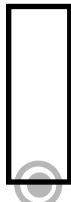
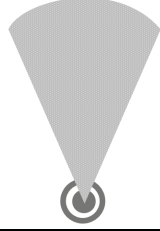
| No. | Drawn object name | Drawn object display example |
|-----|---------------------------------------|--|
| 1 | Own ship symbol (True Scaled Outline) |  |
| 2 | Own ship symbol (Simplified Symbol) |  |
| 3 | Radar antenna position |  |
| 4 | Heading Line |  |
| 5 | Beam Line |  |
| 6 | Stern Line |  |
| 7 | Vector |  |
| 8 | Ground vector indicator |  |
| 9 | Water vector indicator |  |

| No. | Drawn object name | Drawn object display example |
|-----|---|--|
| 10 | Own ship track Time Mark |  |
| 11 | POS2 Symbol |  |
| 12 | PastPOSN |  |
| 13 | Own ship track |  |
| 14 | Vector Time Mark |  |
| 15 | Vector Area (Anti - grounding monitoring) |  |
| 16 | Sector Area (Anti - grounding monitoring) |  |

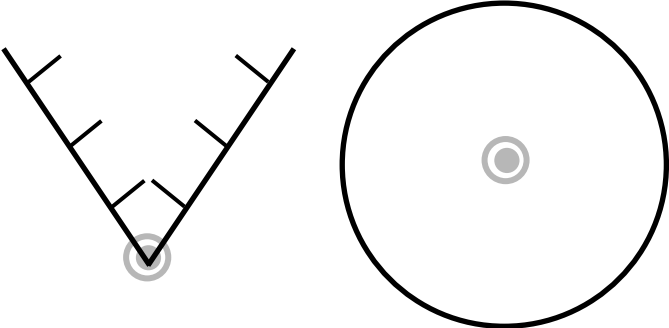
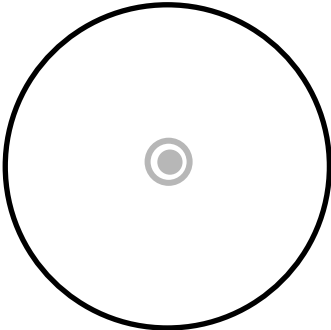
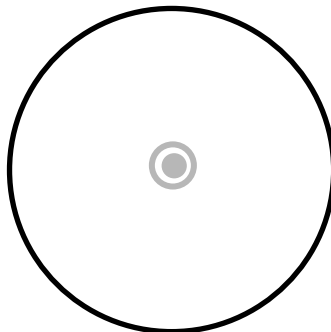

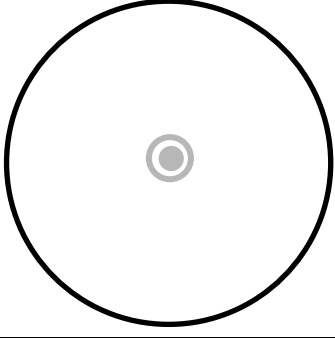
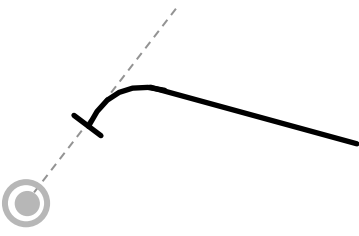

D.6.2 TT/AIS related

| No. | Drawn object name | Drawn object display example |
|-----|-----------------------------------|---|
| 1 | AZ |  |
| 2 | AIS Filter |  |
| 3 | CPA Ring * Thin red circle |  |
| 4 | Limit Ring * Thin green circle |  |
| 5 | Sector Blank |  |

D.6.3 Navigation monitoring related

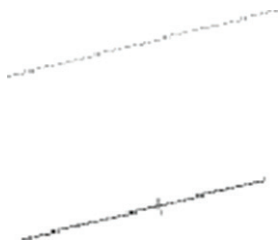
| No. | Drawn object name | Drawn object display example |
|-----|--|--|
| 1 | Dragging anchor monitoring circle * Thin red circle |  |
| 2 | EBL Manoeuvre |  |













D.6.4 Tool related













| No. | Drawn object name | Drawn object display example |
|-----|-------------------|--|
| 1 | Range Ring |  |
| 2 | EBL |  |
| 3 | VRM |  |
| 4 | PI |  |
| 5 | MOB |  |



D.7 List of Icons / Icon Buttons





The icons/icon buttons displayed in this equipment are listed below.

| No. | Name | Functional outline | Displayed image |
|-----|-----------------------------|--|-----------------|
| 1 | Active indicator | Indicates that the computer is processing by an animation. | |
| 2 | Delete | Delete the item. | |
| 3 | Check again | Checks the contents being displayed again. | |
| 4 | Setting mark | Displayed when the operation is valid. (E.g., Latitude and longitude offset of chart) | |
| 5 | Drive | Displayed at the left of the name when a drive is selected. | |
| 6 | Folder | Displayed at the left of the name when a folder is selected. | |
| 7 | Home | Changes from the currently displayed screen to the home screen. | |
| 8 | Close | Closes the dialogue box. | |
| 9 | Date selection | Displays the calendar picker. | |
| 10 | Dialogue box display | Opens another dialogue box. (E.g., [File Operation] dialogue) | |
| 11 | Day/Night | Displays the state of the current Day/Night setting by an icon. | |
| 12 | Screen and panel brightness | Enables adjustment of the screen and panel brightness. | |
| 13 | Mode switching | Changes to the mode, which includes radar mode [a)], synthesis mode [b)]. Icon changes according to mode. | |
| 14 | MOB | Starts the MOB (Man Over Board) mode. In the MOB mode, a symbol display of the position of the sailor falling over board and a dotted line connecting it to the own ship are displayed graphically. | |

| No. | Name | Functional outline | Displayed image |
|-----|----------------------------|--|--|
| 15 | Message notification | When there is a message from outside (AIS safety related messages, etc.), the number of messages is displayed in a badge over the icon. The message window is displayed when the icon is clicked. |  |
| 16 | Menu | "Menu" button with freeze indicator function. Displays the menu. Indicates using animation that the system is operating. |  |
| 17 | Writing tool | Writes in the User map creation mode. |  |
| 18 | Cursor mode selection | Changes the cursor mode to AUTO mode. |  |
| 19 | Undo | Executes an undo operation. |  |
| 20 | Screen capture | Creates the capture image at the time this is pressed. |  |
| 21 | Favourite | The favourite list is displayed. |  |
| 22 | Eraser tool | Changes to the user map deleting mode, and user maps can be deleted successively. |  |
| 23 | Silencing | Silences the alert sound. |  |
| 24 | Multiple knob (small knob) | Displays the functions assigned to the multiple knob. Displayed as an icon with the function name at left. |  |
| 25 | Brightness | Sets the brightness of the screen. |  |
| 26 | Reversal key | Switches the marking position at mark input, which includes position of own ship [a)], position of cursor [b)]. Icon changes according to settings. |  a) b) |
| 27 | Reference mark | Set a reference point, which includes from own ship [a)], from ref. mark 1 to 20 [b)]. Icon changes according to settings. |  a) b) |

| No. | Name | Functional outline | Displayed image |
|-----|-----------------------|---|--|
| 28 | Page selection | The [Page Selection] dialogue box is displayed. |  |
| 29 | Expand List | Displays the TT/AIS list of the standard mode newly in an expanded window. |  |
| 30 | Standard List | Closes the expand mode TT/AIS list (separate window), and displays in the standard mode (information monitoring window pane) |  |
| 31 | Standard AIS | Changes to standard AIS display. |  |
| 32 | Expand AIS | Changes to expanded AIS display. |  |
| 33 | Registering Favourite | Registering/Canceling favourites, which includes unregistered [a]), registered [b]), not be registered[c)]. Icon changes according to settings. |  a) b) c) |
| 34 | Anchor Watch | Monitors the anchor dredging. When the anchor has been lowered, monitors if the ship is being swept away |  |
| 35 | Chart | Opens the Chart related menu. |  CHART |
| 36 | User Map | Opens the user map related menu. It is possible to write marks or lines in the user map. |  |
| 37 | TT/AIS | Opens the TT/AIS related menu. This also has the function of highlighting the display of the TT/AIS symbol depending on the conditions, or the function of sending a message to an AIS ship, etc. |  |
| 38 | Tools | Tool related menu, such as the range and bearing measurement EBL/VRM or PI, etc. |  |
| 39 | View | Opens the View related menu. Settings are made of the display of objects in the radar PPI or in the chart. |  |
| 40 | Alert | Opens the alert related menu. Settings related to the alerts from the equipment can be made. When clicked, the [Alert] dialogue box appears. Alert settings can be made in the dialogue box. |  |

| No. | Name | Functional outline | Displayed image |
|-----|---|--|--|
| 41 | Settings | Opens the menu related to the operation settings of the equipment. |  |
| 42 | Maintenance | The maintenance related menu for the users is displayed. It is possible to check the software version and to monitor the status of the equipment. |  |
| 43 | Help | Opens the help screen. |  |
| 44 | Code Input | Input the password. |  |
| 45 | Service | The menu related to adjustment, servicing, and maintenance is displayed for the servicing personnel. |  |
| 46 | Back space | Carries out a backspace operation. |  |
| 47 | Backward movement of the input position | Moves back the input position. |  |
| 48 | Forward movement of the input position | Moves the input position forward |  |
| 49 | Operation guide | Displays the operation guide when clicked. |  |
| 50 | Search | Displayed in the search text box. |  |
| 51 | Thumbnail / list display selection | Switches between thumbnail and list displays. |  |

| No. | Name | Functional outline | Displayed image |
|-----|--------------------|--|--|
| 52 | All | Consolidated mode of PI This is the mode of operating the orientation and spacing of all the parallel lines. |  |
| 53 | Individual | Individual mode of PI The orientation of each line, the distance from the reference position, and the length are operated independently in this mode. |  |
| 54 | Track | PI tracking mode This is the mode of operating the orientation and spacing between two parallel lines. The two parallel lines are placed to the left and right taking CCRP as the reference. |  |
| 55 | Equiangular | Equal angle mode of PI This is the mode of operating the angle of two lines that intersect at the reference position. |  |
| 56 | Contents selection | The display contents of the pane are changed directly |  |

D.8 Software Licence Agreement

This Software Licence Agreement is made and entered between the user who purchased a product of JMR – 5400 series and Japan Radio Co., Ltd. (hereinafter referred to as "JRC") with regard to the Licence to use the software in the product series.

- You have purchased a device that uses software licence from Microsoft Licence in the U.S. to JRC. The software which was developed by Microsoft installed in the device along with the printed documentation attached to it and its online or electronic documents (hereinafter collectively referred to as the "Software") are protected by international laws and conventions in relation to the protection of intellectual properties.
The licenced Software has not been sold to you and all rights in and to the Software are reserved.
- **If you do not agree to execute this Licence Agreement, you will not be allowed to use the device or copy the Software. If you do not agree to the provisions and terms hereof, you are requested to immediately inform us of your intention to return the device before you start to use it so that JRC can repay you the amount you have paid for it. By using the Software in the state as installed in the device or in any other way, you agree to the provisions of this Licence Agreement (or confirm your prior agreement).**
- **Conditions of the Licence shall be stipulated as follows:**
 - **The Software shall only be licenced for the use in the state as installed in the device you have purchased.**
 - **Indemnification: The Software itself is not free from defects. JRC has defined on its own account how to use the Software installed in JRC's devices. For this reason, Microsoft trust JRC to conduct sufficient tests to determine whether the Software is suitable for such usage as a prerequisite for the use of the Software.**
 - **The Software is provided with no warranties whatsoever: The Software is provided as is and with all faults. You shall bear all the risks whether you can obtain satisfactory quality, performance and accuracy and it shall be your responsibility to make efforts to ensure those including eliminating errors. In addition, there is no warranty in the event of prevention from using the Software or in the case of infringement of any right arising from using the Software. Even if you can have any warranty in relation to the device or the Software, such warranty is not the one provided by Microsoft, and therefore such warranty shall not bind either Microsoft.**
 - **Java support: The Software may include support of programs written in the Java language. The Java technology is not free from defects and is not designed or manufactured for the purpose of use or resell as online controlling equipment for the use in any dangerous environment requiring preparation of safety device in case of an emergency such as in operation of nuclear device, navigation or telecommunication system for aircrafts, air traffic control, life support machine or weapon systems in which failure of the Java technology may directly lead to an event which causes death or serious injury or environmental damage. This statement of disclaimer of liability is the obligation of Microsoft under the contract between Microsoft and Sun Microsystems.**

-
- **Limitation of Liability: Except to the extent prohibited by law, Microsoft shall not be liable for any indirect damages, special damages, consequential damages or incidental damages arising from or in relation to the performance or use of the Software. This limitation of liability shall apply even in the case any remedy for damages may not fulfill its essential purpose. In any event, Microsoft shall not liable for any damages exceeding the amount equal to 250 US\$.**
 - Restriction of reverse engineering, decompiling and disassembling: Except in cases explicitly permitted by applicable laws regardless of the restriction hereunder, you shall not reverse engineer, decompile or disassemble the Software.
 - Export control: You acknowledge that the country of origin of the Software is the United States of America. You agree to comply with export control laws and regulations of the United States of America as well as both domestic laws of the United States of America and international laws applicable to the Software including regulations issued by the U.S. Government or other governments in relation to end users, end use and country of destination.

For additional information on export of the Software, refer to the website: <http://www.microsoft.com/en-us/exporting/default.aspx>.

D.9 Font Licence Agreement

This product uses Migu font (<http://mix-mplus-ipa.sourceforge.jp/migu/>) to display characters on the screen. Migu font data is distributed from the URL stated above. Migu font is distributed in compliance with "IPA Font Licence Agreement v1.0" (http://ipafont.ipa.go.jp/ipa_font_Licence_v1.html). This product loaded with the Migu font is also in compliance with "IPA Font Licence Agreement v1.0." You may use this product under the agreement to the provisions of "IPA Font Licence Agreement v1.0." You have the right to change the font used for the display of this product from Migu font to IPA font. However, there is no need to change the Migu font to IPA font in the specifications of this product. Moreover, this product is designed to provide the display which is optimized for using Migu font. Note that using IPA font for the display may cause a problem of compatibility of font data with regard to the form of some characters resulting in degradation of the display on the screen. If you desire to change from Migu font to IPA font, consult with our service agent.

The typefaces included herein are solely developed by DynaComware Taiwan Inc.

D.10 IPA Font Licence Agreement v1.0

The Licencor provides the licenced Program (as defined in Article 1 below) under the terms of this Licence Agreement (“Agreement”). Any use, reproduction or distribution of the licenced Program, or any exercise of rights under this Agreement by a Recipient (as defined in Article 1 below) constitutes the Recipient's acceptance of this Agreement.

Article 1 (Definitions)

In this Agreement, the following terms set forth in each item shall be defined as therein.

1. “Digital Font Program” shall mean a computer program containing, or used to render or display fonts.
2. “Licenced Program” shall mean a Digital Font Program licenced by the Licencor under this Agreement.
3. “Derived Program” shall mean a Digital Font Program created as a result of a modification, addition, deletion, replacement or any other adaptation to or of a part or all of the licenced Program, and includes a case where a Digital Font Program newly created by retrieving font information from a part or all of the licenced Program or Embedded Fonts from a Digital Document File with or without modification of the retrieved font information.
4. “Digital Content” shall mean products provided to end users in the form of digital data, including video content, motion and/or still pictures, TV programs or other broadcasting content and products consisting of character text, pictures, photographic images, graphic symbols and/or the like.
5. “Digital Document File” shall mean a PDF file or other Digital Content created by various software programs in which a part or all of the licenced Program becomes embedded or contained in the file for the display of the font (“Embedded Fonts”). Embedded Fonts are used only in the display of characters in the particular Digital Document File within which they are embedded, and shall be distinguished from those in any Digital Font Program, which may be used for display of characters outside that particular Digital Document File.
6. “Computer” shall include a server in this Agreement.
7. “Reproduction and Other Exploitation” shall mean reproduction, transfer, distribution, lease, public transmission, presentation, exhibition, adaptation and any other exploitation.
8. “Recipient” shall mean anyone who receives the licenced Program under this Agreement, including one that receives the licenced Program from a Recipient.

Article 2 (Grant of Licence)

The Licencor grants to the Recipient a Licence to use the licenced Program in any and all countries in accordance with each of the provisions set forth in this Agreement. However, any and all rights underlying in the licenced Program shall be held by the Licencor. In no sense is this Agreement intended to transfer any right relating to the licenced Program held by the Licencor except as specifically set forth herein or any right relating to any trademark, trade name, or service mark to the Recipient.

-
1. The Recipient may install the licenced Program on any number of Computers and use the same in accordance with the provisions set forth in this Agreement.
 2. The Recipient may use the licenced Program, with or without modification in printed materials or in Digital Content as an expression of character texts or the like.
 3. The Recipient may conduct Reproduction and Other Exploitation of the printed materials and Digital Content created in accordance with the preceding Paragraph, for commercial or non – commercial purposes and in any form of media including but not limited to broadcasting, communication and various recording media.
 4. If any Recipient extracts Embedded Fonts from a Digital Document File to create a Derived Program, such Derived Program shall be subject to the terms of this agreement.
 5. If any Recipient performs Reproduction or Other Exploitation of a Digital Document File in which Embedded Fonts of the licenced Program are used only for rendering the Digital Content within such Digital Document File then such Recipient shall have no further obligations under this Agreement in relation to such actions.
 6. The Recipient may reproduce the licenced Program as is without modification and transfer such copies, publicly transmit or otherwise redistribute the licenced Program to a third party for commercial or non – commercial purposes (“Redistribute”), in accordance with the provisions set forth in Article 3 Paragraph 2.
 7. The Recipient may create, use, reproduce and/or Redistribute a Derived Program under the terms stated above for the licence d Program: provided, that the Recipient shall follow the provisions set forth in Article 3 Paragraph 1 when Redistributing the Derived Program.

Article 3 (Restriction)

The Licence granted in the preceding Article shall be subject to the following restrictions:

1. If a Derived Program is Redistributed pursuant to Paragraph 4 and 7 of the preceding Article, the following conditions must be met:
 - (1) The following must be also Redistributed together with the Derived Program, or be made available online or by means of mailing mechanisms in exchange for a cost which does not exceed the total costs of postage, storage medium and handling fees:
 - (a) a copy of the Derived Program; and
 - (b) any additional file created by the font developing program in the course of creating the Derived Program that can be used for further modification of the Derived Program, if any.
 - (2) It is required to also Redistribute means to enable recipients of the Derived Program to replace the Derived Program with the licenced Program first released under this Licence (the "Original Program"). Such means may be to provide a difference file from the Original Program, or instructions setting out a method to replace the Derived Program with the Original Program.
 - (3) The Recipient must licence the Derived Program under the terms and conditions of this Agreement.
 - (4) No one may use or include the name of the licenced Program as a program name, font name or file name of the Derived Program.
 - (5) Any material to be made available online or by means of mailing a medium to satisfy the requirements of this paragraph may be provided, verbatim, by any party wishing to do so.

-
2. If the Recipient Redistributes the licenced Program pursuant to Paragraph 6 of the preceding Article, the Recipient shall meet all of the following conditions:
 - (1) The Recipient may not change the name of the licenced Program.
 - (2) The Recipient may not alter or otherwise modify the licenced Program.
 - (3) The Recipient must attach a copy of this Agreement to the licenced Program.
 3. This licenced program is provided by the licencor "as is" and any expressed or implied warranty as to the licenced program or any derived program, including, but not limited to, warranties of title, non – infringement, merchantability, or fitness for a particular purpose, are disclaimed. In no event shall the licencor be liable for any direct, indirect, incidental, special, extended, exemplary, or consequential damages (including, but not limited to; procurement of substituted goods or service; damages arising from system failure; loss or corruption of existing data or program; lost profits), however caused and on any theory of liability, whether in contract, strict liability or tort (including negligence or otherwise) arising in any way out of the installation, use, the reproduction or other exploitation of the licenced program or any derived program or the exercise of any rights granted hereunder, even if advised of the possibility of such damages.
 4. The Licencor is under no obligation to respond to any technical questions or inquiries, or provide any other user support in connection with the installation, use or the Reproduction and Other Exploitation of the licenced Program or Derived Programs thereof.

Article 4 (Termination of Agreement)

1. The term of this Agreement shall begin from the time of receipt of the licenced Program by the Recipient and shall continue as long as the Recipient retains any such licenced Program in any way.
2. Notwithstanding the provision set forth in the preceding Paragraph, in the event of the breach of any of the provisions set forth in this Agreement by the Recipient, this Agreement shall automatically terminate without any notice. In the case of such termination, the Recipient may not use or conduct Reproduction and Other Exploitation of the licenced Program or a Derived Program: provided that such termination shall not affect any rights of any other Recipient receiving the licenced Program or the Derived Program from such Recipient who breached this Agreement.

Article 5 (Governing Law)

1. IPA may publish revised and/or new versions of this Licence. In such an event, the Recipient may select either this Agreement or any subsequent version of the Agreement in using, conducting the Reproduction and Other Exploitation of, or Redistributing the licenced Program or a Derived Program. Other matters not specified above shall be subject to the Copyright Law of Japan and other related laws and regulations of Japan.
2. This Agreement shall be construed under the laws of Japan.

EU Declaration Of Conformity

01) Apparatus Product/Model:

Product: Marine Radar.

Model: JMR-5400 Series

(JMR-5404-X/5406-X/5410-4X/5410-4XH/5410-6X/5410-6XH/5425-7X/5425-9X

/5425-6XH/5430-S/5472-S/5482-S/5482-SH)

02) Name & Address of the Manufacturer:

Japan Radio Co., Ltd.,

21-11, Mure 6-chome, Mitaka-shi, Tokyo 181-0002 Japan.

03) This declaration of conformity is issued under the sole responsibility of the manufacturer.

04) Object of the declaration – identification of apparatus allowing traceability:

- Marine Radar, Japan Radio Co., Ltd manufactured model JMR-5404-X.
- Marine Radar, Japan Radio Co., Ltd manufactured model JMR-5406-X.
- Marine Radar, Japan Radio Co., Ltd manufactured model JMR-5410-4X.
- Marine Radar, Japan Radio Co., Ltd manufactured model JMR-5410-4XH.
- Marine Radar, Japan Radio Co., Ltd manufactured model JMR-5410-6X.
- Marine Radar, Japan Radio Co., Ltd manufactured model JMR-5410-6XH.
- Marine Radar, Japan Radio Co., Ltd manufactured model JMR-5425-7X.
- Marine Radar, Japan Radio Co., Ltd manufactured model JMR-5425-9X.
- Marine Radar, Japan Radio Co., Ltd manufactured model JMR-5425-6XH.
- Marine Radar, Japan Radio Co., Ltd manufactured model JMR-5430-S.
- Marine Radar, Japan Radio Co., Ltd manufactured model JMR-5472-S.
- Marine Radar, Japan Radio Co., Ltd manufactured model JMR-5482-S.
- Marine Radar, Japan Radio Co., Ltd manufactured model JMR-5482-SH.

05) The object of the declaration described above is in conformity with the relevant EU harmonization legislation:

Radio Equipment Directive (RED): 2014/53/EU.

06) References to the relevant harmonized standards used, including the date of the standard, or references to other technical specifications, including the date of the specification, in relation to which conformity is declared:

EN60945:2002 (Ed4) - General Requirements for Marine Equipment.

ETSI EN 302 248 (v2.1.1) – Navigation radar for use on non-SOLAS vessels.

IEC61162 series – as applicable.

07) Notified Body involved:

Not applicable.

08) Description of accessories and components, including software:

| System Components | | JMR-5404-X | JMR-5406-X | JMR-5410-4X | MR-5410-4XH | JMR-5410-6X | JMR-5410-6XH | JMR-5425-7X | JMR-5425-9X | JMR-5425-6XH | JMR-5430-S | JMR-5472-S | JMR-5482-S | JMR-5482-SH |
|---|--|------------|------------|-------------|-------------|-------------|--------------|-------------|-------------|--------------|------------|------------|------------|-------------|
| Display Unit | NCD-2315 ^{note 1} NCD-2316 ^{note 2} | X | X | X | X | X | X | X | X | X | X | X | X | X |
| 4kW Radome Scanner Unit | NKE-2043 | X | | | | | | | | | | | | |
| 6kW Slot Antenna Scanner Unit | NKE-2063A | | X | | | | | | | | | | | |
| 10kW Slot Antenna Scanner Unit | NKE-2103-4 | | | X | | | | | | | | | | |
| 10kW Slot Antenna Scanner Unit/ High speed craft | NKE-2103-4HS | | | | X | | | | | | | | | |
| 10kW Slot Antenna Scanner Unit | NKE-2103-6 | | | | | X | | | | | | | | |
| 10kW Slot Antenna Scanner Unit/ High speed craft | NKE-2103-6HS | | | | | | X | | | | | | | |
| 25kW Slot Antenna Scanner Unit | NKE-2255-7 | | | | | | | X | | | | | | |
| 25kW Slot Antenna Scanner Unit | NKE-2255-9 | | | | | | | | X | | | | | |
| 25kW Slot Antenna Scanner Unit High speed craft | NKE-2255-6HS | | | | | | | | | X | | | | |
| 30kW Slot Antenna Scanner Unit | NKE-1130/A | | | | | | | | | | X | | | |
| 250W Slot Antenna Scanner Unit | NKE-1632/A | | | | | | | | | | | X | | |
| 250W Slot Antenna Scanner Unit | NKE-2632/A | | | | | | | | | | | | X | |
| 250W Slot Antenna Scanner Unit High speed craft | NKE-2632-H | | | | | | | | | | | | | X |

Software version: Scanner Unit NKE-2043 V01.00
Scanner Unit NKE-2063A V01.00
Scanner Unit NKE-2103-4/4HS/6/6HS V01.00
Scanner Unit NKE-2255-7/9/6HS V01.00
Scanner Unit NKE-1130/A V01.00
Scanner Unit NKE-1632/A V01.00
Scanner Unit NKE-2632/A V01.00
Scanner Unit NKE-2632-H V01.00
Radar Processor NDC-1678/A V01.00

NOTES:

- 1 The NCD-2315 consists of the NWZ-214 19” LCD Display Unit,NDC-1678/A Radar Processor Unit and NCE-5794 Operation Unit.
- 2 The NCD-2316 consists of the NWZ-208 26” LCD Display Unit,NDC-1678/A Radar Processor Unit and NCE-5794 Operation Unit.

09) Additional Information:

Antenna length 2ft, Peak power 4kW(Magnetron) X-Band Scanner Unit:NKE-2043.
Antenna length 3.9ft, Peak power 6kW(Magnetron) X-Band Scanner Unit:NKE-2063A.
Antenna length 4ft, Peak power 10kW(Magnetron) X-Band Scanner Unit:NKE-2103-4.
Antenna length 4ft, Peak power 10kW(Magnetron) X-Band Scanner Unit:NKE-2103-4HS.
Antenna length 6ft, Peak power 10kW(Magnetron) X-Band Scanner Unit:NKE-2103-6.
Antenna length 6ft, Peak power 10kW(Magnetron) X-Band Scanner Unit:NKE-2103-6HS.
Antenna length 7ft, Peak power 25kW(Magnetron) X-Band Scanner Unit:NKE-2255-7.
Antenna length 9ft, Peak power 25kW(Magnetron) X-Band Scanner Unit:NKE-2255-9.
Antenna length 6ft, Peak power 25kW(Magnetron) X-Band Scanner Unit:NKE-2255-6HS.
Antenna length 12ft, Peak power 30kW(Magnetron) S-Band Scanner Unit:NKE-1130/A.
Antenna length 12ft, Peak power 250W(Solid State) S-Band Scanner Unit:NKE-1632/A.
Antenna length 8ft, Peak power 250W(Solid State) S-Band Scanner Unit:NKE-2632/A.
Antenna length 8ft, Peak power 250W(Solid State) S-Band Scanner Unit:NKE-2632-H.

Signed for and on behalf of: Japan Radio Co., Ltd., Tokyo, Japan.

Place and date of issue: Nagano-shi, Nagano ,Japan Dated 28th July 2021
Navigation Group
Quality Assurance Department
Marine Systems

Name/function: Koji Ogawa / Manager

Signed: 

Code: 7ZPRD0977

We Japan Radio Co., Ltd. declare that the JRC Radar JMR-5400 corresponds with Technical regulations concerning the safety of sea transport facilities (approved by the Russian Federal Government in its Order No. 620 of August 12, 2010).

1. Products Classification (Annex 1 to Technical regulations concerning the safety of sea transport facilities)

| All Russian Products Classification Code | Designation of technical regulation item | Regulations of 1974* Convention, Resolutions and Circulars of International Maritime Organization which should be met by technical regulation items |
|--|--|--|
| 648700 | Automatic radar plotting equipment | Reg. V/18.1, V/19.2.3.2, V/19.2.7.1 and V/19.2.8.1, Resolution A 278 (VIII), Resolution A 477 (XII), Annex 4 to Resolution MSC.64 (67), Resolution A.823 (19), Resolution A.694 (17) |

* International Convention for the Prevention of Pollution from Ships as Modified by the Protocol of 1978 1978 Relating Thereto (Convention, 1973);

2. Present procedures for products intended for operation in the territory of the Russian Federation for ships entitled to fly the flag of the Russian Federation:

2.1 Warning signs (Warning Labels) to be made in the Russian language.

2.2 The products labeled with a conformity mark, as prescribed by the Russian Federation laws concerning technical regulation (The Russian Federation Government Order "On Conformity Mark" No. 696 of 19 November 2003).

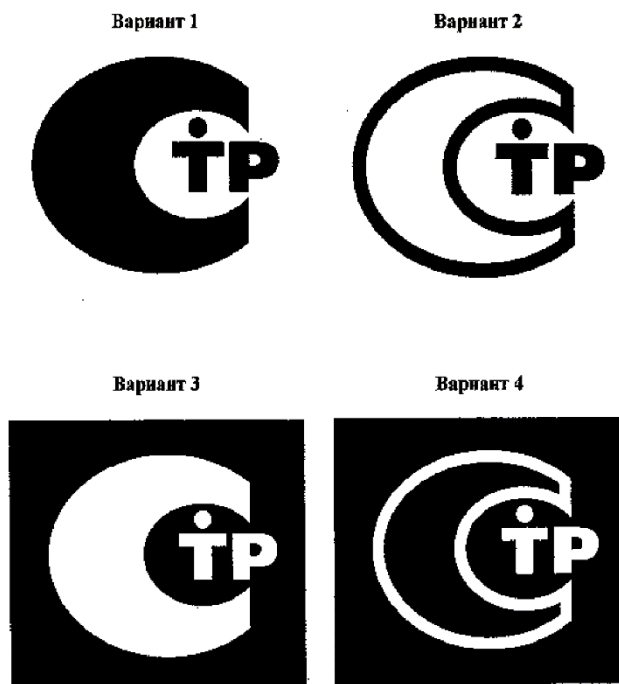

2.3 Disposal (utilization) of products should be made in conjunction with the ship on a single technology or separately in accordance with the Federal Law of the Russian Federation No.89 FZ "On Waste of Production and Consumption".

アスベストは使用しておりません
Not use the asbestos

JRC *Japan Radio Co., Ltd.*

URL : <https://www.jrc.co.jp/>

Marine Service Department

1-7-32 Tatsumi, Koto-ku, Tokyo 135-0053, Japan

e-mail : tmsc@jrc.co.jp

One-call: +81-50-3786-9201

ISO9001, ISO14001 Certified.

Code No. 7ZPRD0950

OCT. 2023 Edition 8