

JMR-7230-S3/S
JMR-7225-7X3/9X3/6X/9X/6XH
JMR-7210-6X/6XH
JMR-7272-S
JMR-7282-S/SH
JMR-7296-6X/9X
JMR-9230-S3/S
JMR-9225-7X3/9X3/6X/9X/6XH
JMR-9210-6X/6XH
JMR-9272-S
JMR-9282-S/SH
JMR-9296-6X/9X

Marine Radar Equipment

Instruction Manual

<Function>

Overview	1
Name and Function of Each Unit	2
Common Basic Operations	3
Range and Bearing Measurement Methods	4
Basic Operation of the Radar	5
Target Tracking and AIS	6
True and False Echoes on Display	7
Functions of the ECDIS	8
Route Planning	9
Route Monitoring	10
Monitoring a Dragging Anchor	11
Automatic Sailing	12
Operating a Chart	13
Creating a User Chart/ Updating a Chart Manually	14
Logbook	15
Setting Up Screen View	16
Setting Up Alerts	17
Setting Up the Operation Mode	18
Adjusting and Setting Up Equipment (for Services)	19
Playing Back Data Recorded During Navigation [Playback]	20
Maintenance & Inspection	21
Failures and After-Sale Services	22
About Disposal	23
Specifications	24
Radar Antenna Block Diagrams	APP A
Alert List	APP B
Setting the Interswitch	APP C
Menu List and Materials	APP D

Contents

Function

Section 5	Basic Operation of the Radar.....	5-1
5.1	Overview Flowchart.....	5-1
5.2	Starting and Shutting Down the Radar	5-3
5.2.1	Powering on and starting	5-3
5.2.2	Exiting radar operation.....	5-6
5.3	Observation Environment and Image Adjustment	5-7
5.3.1	Adjusting screen brightness.....	5-7
5.3.2	Changing the observation range.....	5-7
5.3.3	Adjusting tune	5-9
5.3.4	Adjusting gain	5-10
5.3.5	Rejecting sea clutter (Sea)	5-12
5.3.6	Rejecting rain/snow clutter.....	5-14
5.3.7	Adjusting to optimal images (Selection of observation scenes)	5-16
5.4	General Radar Operation.....	5-19
5.4.1	Interference Rejection (IR Function).....	5-19
5.4.2	Changing the transmitter pulse length	5-20
5.4.3	Enhancing targets	5-21
5.4.4	Using video processing (Echo Process).....	5-22
5.4.5	Setting the azimuth mode	5-23
5.4.6	Setting a motion mode	5-25
5.4.6.1	Resetting Own Ship to its Initial Position in [TM] (True Motion display) Mode	5-26
5.4.7	Setting the Stabilization Mode	5-27
5.4.8	Moving own ship's display position (Off Center).....	5-27
5.4.9	Displaying other ship's trails (Trails)	5-28
5.4.9.1	Trails motion mode.....	5-28
5.4.9.2	Changing motion mode of trails	5-30
5.4.9.3	Setting the length of the trail	5-30
5.4.9.4	Clearing trails data	5-31
5.4.10	Doubling the size of radar image	5-32
5.4.11	Hiding the heading line (HL OFF)	5-34
5.4.12	Hiding graphics information on radar display	5-35
5.4.13	Setting true bearing.....	5-35
5.4.14	Setting own ship speed.....	5-36
5.4.14.1	Switching own ship speed device	5-36
5.4.14.2	Entering the ship's heading/own ship's speed manually.....	5-38

Section 6	Target Tracking and AIS	6-1
6.1	Restrictions	6-2
6.2	Collision Avoidance Issue (Explanation).....	6-3
6.2.1	Collision Avoidance in Navigation.....	6-3
6.2.2	Marine Accidents and Collisions	6-3
6.2.3	Basic Concept of Collision Avoidance	6-4
6.2.4	Relative Vector and True Vector	6-5
6.2.5	Radar and Collision Avoidance.....	6-5
6.3	Displaying Symbols.....	6-6
6.3.1	Displaying/hiding target tracking symbols/AIS target symbols.....	6-6
6.3.2	Types and Definitions of Target Tracking Symbols.....	6-6
6.3.3	Types and Definitions of AIS Target Symbols.....	6-7
6.3.4	About AIS AtoN (Aids to Navigation).....	6-13
6.3.5	About AIS-SART Information	6-13
6.3.6	About Display Priority of AIS Targets.....	6-14
6.3.7	Switching between Ground Vector and Water Vector.....	6-15
6.3.8	Association Target Symbols.....	6-15
6.4	Preparation.....	6-16
6.4.1	Setting the Cursor Mode to AUTO Mode	6-16
6.4.2	Setting Vector.....	6-16
6.4.2.1	Vector modes	6-16
6.4.2.2	Setting vector mode	6-18
6.4.2.3	Vector Length (Vector Time).....	6-18
6.4.2.4	Setting the Vector Length.....	6-19
6.4.3	Setting collision decision criteria.....	6-19
6.4.3.1	Setting CPA limit.....	6-19
6.4.3.2	Setting TCPA limit.....	6-20
6.4.4	Showing the CPA ring (RADAR only)	6-21
6.5	Setting and Operating Target Tracking	6-22
6.5.1	Acquiring target.....	6-22
6.5.1.1	Automatic acquisition (automatic acquisition) mode	6-22
6.5.1.2	ACQ MANUAL (manual acquisition) mode	6-23
6.5.1.3	Using manual acquisition and auto acquisition together.....	6-24
6.5.2	Setting up the automatic acquisition/activation zone (AZ).....	6-24
6.5.2.1	Using [New Target Warning] dialog box in the [Alert] menu.....	6-25
6.5.2.2	Using the cursor	6-26
6.5.2.3	Using the EBL/VRM dial for the setting.....	6-27
6.5.3	Tracked target information display.....	6-28
6.5.4	Erasing unwanted tracked targets	6-29
6.5.5	Displaying Target ID No.	6-30
6.5.6	Editing tracked target properties.....	6-32
6.5.6.1	Adding Tracked Target ID Name	6-32

6.5.6.2	Setting track color of tracked target	6-34
6.5.7	Setting target for which ground is fixed to a reference target.....	6-35
6.5.8	Operation Test for Target Tracking.....	6-37
6.5.8.1	[Test Video].....	6-38
6.5.8.2	[TT Simulator] (Target tracking simulator).....	6-39
6.5.8.3	[Gate Display].....	6-41
6.5.8.4	[Status] display	6-43
6.6	Setting and Operating AIS.....	6-44
6.6.1	Enabling AIS Function	6-44
6.6.2	Activating AIS targets (Activate AIS).....	6-44
6.6.2.1	Manual activation	6-44
6.6.2.2	Automatic activation	6-45
6.6.3	Deactivating AIS targets	6-45
6.6.4	Displaying AIS information.....	6-46
6.6.5	Displaying Target ID No.	6-54
6.6.6	Checking and setting AIS target property	6-55
6.6.6.1	Setting track color of AIS target.....	6-55
6.6.7	Conditions for deciding AIS target to be lost.....	6-56
6.7	Alert Display	6-57
6.7.1	Danger target alarm (CPA/TCPA).....	6-58
6.7.2	Alarm for new target acquired in automatic acquisition guard zone (New target).....	6-59
6.7.3	Lost target notification (Lost)	6-60
6.7.4	Target Tracking function alarm (TT Data)	6-61
6.7.5	Gyro set notification (Set Gyro)	6-61
6.8	Track Function.....	6-62
6.8.1	Setting the Past position	6-62
6.8.2	Setting the other ship's tracks.....	6-62
6.8.2.1	Setting track color	6-63
6.8.2.2	Turning on/off other ship's track function	6-63
6.8.2.3	Setting other ship's track colors	6-63
6.8.2.4	Turning on/off other ship's track display.....	6-63
6.8.2.5	Setting up the display interval of other ship's track.....	6-64
6.8.2.6	Clearing other ship's track.....	6-64
6.8.2.7	Saving and loading other ship's track data	6-64
6.9	Entering Own Ship's AIS Voyage Data	6-65
6.10	Editing and Sending AIS Messages.....	6-66
6.11	AIS Message Tray.....	6-69
6.11.1	Displaying the AIS message tray	6-69
6.11.2	Switching message display.....	6-71
6.11.3	Sending a message in the message tray after editing.....	6-73
6.12	Highlighting TT/AIS Symbols	6-74
6.13	Trial Maneuvering.....	6-76

6.13.1	Outline of Trial Maneuvering.....	6-76
6.13.2	Performing a trial maneuver	6-79
6.14	Displaying the TT/AIS Target List.....	6-81
6.14.1	Displaying TT/AIS List.....	6-81
6.14.1.1	Switching between a standard window and an extended window	6-82
6.14.2	TT List	6-84
6.14.3	AIS List.....	6-85
6.15	Confirming Own Ship's AIS Information	6-87
6.16	Displaying the Last Lost AIS Target	6-88
Section 7 True and False Echoes on Display		7-1
7.1	Radar Wave with the Horizon	7-1
7.2	Intensity Reflected from the Target	7-3
7.3	Sea Clutter and Rain/Snow Clutter	7-5
7.3.1	Sea clutter	7-5
7.3.2	Rain and snow clutter	7-6
7.3.3	Coping with sea clutter and rain/snow clutter	7-8
7.4	False Echoes	7-9
7.4.1	Shadow	7-9
7.4.2	Side lobe effect	7-9
7.4.3	False echo by secondary reflection	7-10
7.4.4	False echo by multiple reflection	7-11
7.4.5	Second time echoes	7-11
7.4.6	Radar interference	7-12
7.5	Radar Transponder (SART) Screen Display	7-13
7.6	Display of AIS-SART	7-15
7.6.1	Radar screen display example	7-15
7.6.2	Numeric data display example.....	7-16
Section 8 Functions of the ECDIS (Option)		8-1
8.1	General Flowchart.....	8-1
8.1.1	Work Flowchart While Sailing	8-2
8.2	Starting and Preparing the ECDIS	8-3
8.2.1	Powering on and starting	8-3
8.2.2	Starting the ECDIS.....	8-4
8.2.2.1	Starting the ECDIS from the Task Menu	8-4
8.2.2.2	Starting ECDIS from a non-ECDIS task screen.....	8-5
8.2.3	Entering an ARCS PIN Number (ARCS Only).....	8-6
8.3	Moving the Chart.....	8-7
8.3.1	Moving the chart with the [HOME] button	8-7
8.3.2	Moving the chart with the cross-hair cursor	8-8
8.3.3	Moving the chart with the hand cursor.....	8-9
8.3.4	Switching a chart to be displayed by [My Port List]	8-10

8.3.5	Displaying the chart by entering the position.....	8-11
8.4	Zooming In/Out the Chart.....	8-12
8.4.1	Enlarging a Selected Area (S-57/C-MAP Only).....	8-12
8.4.2	Enlarging/reducing a chart with the Zoom function	8-14
8.4.2.1	Enlarging/reducing with the [ZOOM IN]/[ZOOM OUT] key on the trackball operation unit (S-57/C-MAP only)	8-14
8.4.2.2	Enlarging/reducing with the zoom slider (S-57/C-MAP only).....	8-14
8.4.2.3	Enlarging/reducing with the [Large]/[Small] buttons (RNC only).....	8-16
8.4.3	Switching between scale and range (S-57/C-MAP only).....	8-17
8.5	Changing the Object Category (S-57/C-MAP Only).....	8-18
8.5.1	Switching object display.....	8-19
8.5.2	Customizing object display	8-20
8.6	Selecting Motion/Bearing Mode	8-22
8.6.1	Setting motion mode.....	8-23
8.6.2	Setting Bearing mode (S-57/C-MAP only).....	8-25
8.7	Registering and Displaying My Port List.....	8-27
8.7.1	Registering to My Port List.....	8-27
8.7.2	Deleting a port.....	8-28
8.8	Selecting a S-57 chart.....	8-29
8.9	Selecting an ARCS chart.....	8-30
8.9.1	Selecting charts from all	8-30
8.9.2	Changing active panels (ARCS only)	8-31
8.9.3	Changing a low resolution chart (ARCS only)	8-32
8.9.4	Changing a high resolution chart (ARCS only)	8-33
8.9.5	Displaying the note and diagram (ARCS only)	8-34
8.10	Multi View Display and Wide Range View Window Display of Charts.....	8-35
8.10.1	Display of multi view	8-36
8.10.1.1	Displaying multi view.....	8-36
8.10.1.2	Multi view operation procedure	8-38
8.11	Verifying Object Information (Pick Report Function).....	8-42
8.11.1	Pick Report of the S-57 chart.....	8-42
8.11.1.1	Displaying a Pick Report of the S-57 chart	8-42
8.11.1.2	Verifying Object Information	8-44
8.11.1.3	Verifying Chart Information.....	8-49
8.11.1.4	Verifying Chart Update History.....	8-50
8.11.2	Pick report of the C-MAP chart.....	8-51
8.11.3	Pick report of the ARCS chart.....	8-52
8.12	Marking the Position of Own Ship with an Event Mark	8-53
8.13	Displaying Radar Images on a Chart by Overlaying.....	8-54
8.13.1	Turning On/Off overlay display	8-55
8.13.2	Turning On/Off range ring display.....	8-57
8.13.3	Turning On/Off bearing scale.....	8-58

8.13.4	Radar image adjustment.....	8-59
8.14	Setting a true bearing.....	8-60
8.15	Setting an own ship's speed	8-61
8.15.1	Switching an own ship's speed sensor	8-61
8.15.2	Entering the ship's heading/own ship's speed manually	8-62
Section 9	Route Planning.....	9-1
9.1	Overview of the Route Planning Function.....	9-2
9.2	Setting Route Display.....	9-3
9.2.1	Setting [Route] after selecting [View] - [Options] on the menu.....	9-3
9.2.2	Setting [Settings] - [Route] on the menu.....	9-5
9.3	Starting and Ending the [Route Planning] Dialog Box	9-9
9.3.1	Starting the [Route Planning] dialog box	9-9
9.3.2	Ending the [Route Planning] dialog box.....	9-9
9.4	Name and Function of Each Section of the [Route Planning] dialog Box.....	9-10
9.4.1	Route Planning bar	9-10
9.4.2	Route planning tab.....	9-15
9.5	Saving a Route.....	9-17
9.6	Planning a Route by Using Table Editing.....	9-21
9.6.1	Table editing operation flow	9-21
9.6.1.1	Creating a new route file	9-21
9.6.1.2	Editing a route	9-22
9.6.2	Creating a new route file by table editing	9-23
9.6.3	Deleting WPT data.....	9-26
9.6.4	Editing a route by table editing	9-26
9.6.4.1	Inserting WPT.....	9-29
9.6.4.2	Deleting WPT	9-29
9.6.4.3	Dividing a leg.....	9-30
9.6.4.4	Copying the entire route.....	9-30
9.6.4.5	Pasting the copied route	9-31
9.6.4.6	Inserting the other route	9-31
9.6.4.7	Insert the same WPT as the last WPT	9-32
9.7	Planning a New Route by Graphic Editing.....	9-33
9.7.1	Graphic editing operation flow	9-33
9.7.1.1	Creating a new route file	9-33
9.7.1.2	Editing a route file	9-34
9.7.2	Creating a new route file by graphic editing	9-35
9.7.2.1	Creating a route by using EBL/VRM	9-37
9.7.2.2	Creating a route by using the assistant circle function.....	9-39
9.7.3	Editing a route by graphic editing	9-41
9.7.3.1	Inserting a WPT between WPTs	9-43
9.7.3.2	Moving a WPT.....	9-44
9.7.3.3	Changing XTD (cross track limit)	9-46

9.7.3.4	Adding WPT on the context menu	9-47
9.7.3.5	Moving WPT on the context menu	9-48
9.7.3.6	Deleting WPT on the context menu	9-49
9.7.3.7	Copying and pasting a route on the context menu	9-50
9.7.3.8	Rotating a route on the context menu	9-51
9.7.3.9	Moving a route on the context menu	9-52
9.7.3.10	Inserting other route on the context menu	9-53
9.7.3.11	Inserting WPT between WPTs on the context menu	9-54
9.7.3.12	Dividing a leg on the context menu	9-56
9.7.3.13	Changing XTD (cross track limit) on the context menu	9-57
9.8	Creating an Alternate Route	9-59
9.8.1	Creating an alternate route	9-61
9.8.2	Saving an alternate route	9-62
9.8.2.1	Overwriting without changing the file name	9-62
9.8.2.2	Saving the file by naming	9-63
9.9	Checking Route Data	9-64
9.9.1	Checking a route based on the safety standards	9-64
9.9.2	Checking a route based on the limits	9-68
9.10	Navigation Calculation Function	9-70
9.10.1	ROT (Rate of Turn)	9-70
9.10.2	ETA (Estimated Time of Arrival)	9-70
9.10.3	TWOL (Time to Go)	9-71
9.11	Importing/Exporting a Route File	9-72
9.11.1	Importing a route file	9-72
9.11.2	Exporting a route file	9-73
9.12	Error Messages that are Displayed when a Route is Created	9-74
Section 10	Route Monitoring	10-1
10.1	Route Monitoring	10-1
10.1.1	Starting route monitoring	10-1
10.1.2	Ending route monitoring	10-2
10.2	Selecting and Deleting Route Files	10-3
10.2.1	Selecting a route to be displayed	10-3
10.2.2	Deleting a route file	10-4
10.3	[Voyage Information] (Voyage Monitoring Information) Dialog Box	10-5
10.4	[Voyage Calculation] Dialog Box	10-11
10.4.1	Calculating a schedule	10-13
10.4.2	Calculating a distance	10-14
10.4.3	Example of distance calculation	10-16
10.5	Comparing the Data between the Planned Route and the Actual Route	10-18
10.6	Verifying Detail Information of WPT	10-20

Section 11	Monitoring a Dragging Anchor	11-1
11.1	Setting a Dragging Anchor Monitoring Area.....	11-2
11.1.1	Setting a dragging anchor monitoring circle	11-2
11.1.2	Setting a dragging anchor monitoring polygon	11-4
11.2	Starting and Ending Dragging Anchor Monitoring.....	11-5
11.2.1	Starting dragging anchor monitoring.....	11-5
11.2.2	Ending dragging anchor monitoring.....	11-6
11.3	Editing/Deleting a Dragging Anchor Monitoring Area on the Chart.....	11-7
11.3.1	Changing a size of a dragging anchor monitoring circle on the chart	11-7
11.3.2	Changing a size of a dragging anchor monitoring circle on the context menu.....	11-8
11.3.3	Changing a shape of a dragging anchor monitoring polygon on the chart.....	11-8
11.3.4	Changing a shape of a dragging anchor monitoring polygon on the context menu ...	11-9
Section 12	Automatic Sailing (Option).....	12-1
12.1	Flow of Starting Automatic Sailing	12-2
12.2	Selecting a Route.....	12-6
12.2.1	Using the existing planned route	12-6
12.2.2	Creating a new route	12-8
12.3	Selecting a Waypoint at which Automatic Sailing Starts	12-10
12.4	Starting Automatic Sailing	12-12
12.5	Stopping Automatic Sailing	12-14
12.6	Alerts at Automatic Sailing	12-15
Section 13	Operating a Chart (option).....	13-1
13.1	Updating a Chart Manually.....	13-3
13.2	Displaying/Searching an S-57 Chart [Select S-57 Chart]	13-4
13.2.1	Displaying a chart	13-4
13.2.2	Search a chart.....	13-5
13.2.2.1	Searching the position that is clicked on by the cursor.....	13-5
13.2.2.2	Searching by using a chart name.....	13-6
13.3	Displaying a Chart by Inputting a Position	13-7
13.4	Confirming/Accepting/Rejecting an S-57 Updated Chart.....	13-8
13.5	Displaying a Date-dependent Object	13-10
13.6	Displaying a Chart Boundary	13-12
13.6.1	Setting a boundary to be displayed on the chart	13-12
13.6.2	Displaying chart information	13-13
13.7	Confirming Temporary/Preliminary Information of an ARCS Chart.....	13-14
13.8	Adjusting an ARCS Chart Position.....	13-15
13.8.1	Offsetting an ARCS chart.....	13-15
13.8.2	Transforming a geodetic datum of an ARCS chart to WGS-84	13-17
13.9	Displaying a Chart Abbreviation List	13-21
13.10	Displaying an ENC Update Status Report.....	13-22

13.11	Displaying update data of the C-MAP chart.....	13-27
13.12	Displaying license information of C-MAP.....	13-29
13.12.1	Setting license information display to ON.....	13-29
13.12.2	C-MAP license information.....	13-30
13.12.2.1	License information display timing.....	13-30
13.12.2.2	License information.....	13-32
13.13	Displaying ECDIS Chart 1.....	13-33
13.13.1	Import ECDIS Chart 1.....	13-33
13.13.2	Confirm display of ECDIS Chart 1.....	13-34
13.14	Displaying differences at chart update.....	13-36
13.14.1	Displaying differences at S-57 chart update.....	13-36
13.14.2	Displaying differences at C-MAP chart update.....	13-37
13.15	Chart pick report.....	13-38
13.16	Maintaining a Chart.....	13-39
Section 14	Creating a User Chart/ Updating a Chart Manually	14-1
14.1	Creating/Editing a User Chart.....	14-3
14.1.1	Display the "User Chart" menu.....	14-4
14.1.2	Display the File Operation submenu.....	14-5
14.1.2.1	[File Operation] dialog box.....	14-5
14.1.3	Creating a new user chart.....	14-7
14.1.4	Editing the existing user chart.....	14-8
14.1.4.1	Editing the user chart that is currently displayed.....	14-8
14.1.5	Displaying a user chart.....	14-9
14.1.6	Operating a user chart file.....	14-10
14.1.6.1	Deleting a user chart file.....	14-10
14.1.6.2	Copying a user chart file.....	14-10
14.1.6.3	Importing a user chart file.....	14-11
14.1.6.4	Exporting a user chart file.....	14-11
14.1.6.5	Merging multiple user chart files.....	14-12
14.1.6.6	Performing geodetic datum conversion.....	14-13
14.2	Using Map Creation Tools (User Chart Creation/Editing).....	14-14
14.2.1	User chart information bar.....	14-14
14.2.1.1	Displaying a user chart information bar.....	14-14
14.2.2	Drawing toolbar.....	14-15
14.2.3	Selecting an object type.....	14-16
14.2.3.1	Using a user chart object.....	14-17
14.2.4	Selecting a color of an object.....	14-18
14.2.5	Creating an object in the EBL/VRM mode.....	14-19
14.2.6	Creating an object by specifying latitude and longitude.....	14-19
14.2.6.1	Creating an object of symbol/circle/ellipse/arc/arrow/text.....	14-20
14.2.6.2	Creating an object of simple line/polygon/highlight.....	14-20
14.2.7	Deleting an object.....	14-20

14.2.8	Object property dialog box.....	14-21
14.2.8.1	Selecting an object.....	14-21
14.2.8.2	Setting a comment.....	14-22
14.2.9	Changing an object display scale range.....	14-23
14.2.10	Moving an object.....	14-23
14.3	Updating a Chart Manually (ARCS) (ECDIS Screen Only).....	14-25
14.3.1	Displaying the Manual Update submenu.....	14-26
14.3.2	Selecting a chart to be updated.....	14-27
14.3.2.1	Searching the position that is clicked on with the cursor.....	14-28
14.3.2.2	Searching a chart with the chart name.....	14-28
14.3.2.3	Displaying the chart screen that is selected from the list.....	14-28
14.3.3	Updating a chart manually.....	14-29
14.3.4	Displaying the selected chart only.....	14-30
14.3.5	Displaying the object/redisplaying the hidden object.....	14-30
14.4	How to Use the Map Creation Tools (At Manual Update of ARCS).....	14-31
14.4.1	Deleting or hiding an object.....	14-31
14.4.2	Selecting an object type.....	14-32
14.5	Creating an Object(At Manual Update of ARCS).....	14-33
14.5.1	Creating a symbol object (Symbol).....	14-34
14.5.1.1	Creating an object by specifying the latitude and longitude.....	14-34
14.5.1.2	Creating an object with EBL/VRM operation.....	14-35
14.5.2	Creating a simple line and Alerts line (Line object).....	14-36
14.5.2.1	Creating a vertex by entering the position.....	14-39
14.5.2.2	Creating an object with EBL/VRM operation.....	14-39
14.5.3	Creating a circle, ellipse, and an arc (Line object).....	14-41
14.5.3.1	Creating an object by specifying a position for the center and size of the object.....	14-43
14.5.4	Creating a polygon and Alerts area (Area object).....	14-44
14.5.4.1	Creating a vertex by entering the position.....	14-46
14.5.4.2	Creating an object with EBL/VRM operation.....	14-47
14.5.5	Creating circle, ellipse, and fan areas (Area object).....	14-49
14.5.5.1	Creating an object by specifying the center position and the object size.....	14-51
14.5.6	Creating a text (Text object).....	14-52
14.5.6.1	Creating a text by specifying the latitude and longitude.....	14-53
14.5.6.2	Creating a text with EBL/VRM operation.....	14-53
14.5.6.3	Editing a text.....	14-54
14.5.6.4	Editing a template.....	14-54
14.5.6.5	Changing a text angle.....	14-56
14.5.7	Creating an arrow (Line object).....	14-57
14.5.7.1	Creating an object by specifying the starting point/ending point position coordinates.....	14-58
14.5.7.2	Drawing an object with EBL/VRM operation.....	14-59
14.5.8	Creating Mariner's Mark/Line drawing objects (ECDIS screen only).....	14-60

14.5.8.1	Information mark	14-60
14.5.8.2	Clearing line	14-62
14.5.8.3	Tidal Stream mark	14-65
14.5.8.4	Highlighted display	14-67
14.6	Collective Deletion of Objects [Delete by Type/Color]	14-73
14.7	Managing/Editing Objects [Mark Line/List].....	14-74
14.7.1	Displaying the [Mark/Line List] dialog box	14-74
14.7.2	Displaying a user chart list.....	14-75
14.7.2.1	Displaying an object on a chart.....	14-75
14.7.2.2	Deleting an object	14-75
14.7.3	Displaying a Mariner's Mark/Line List (ECDIS screen only)	14-76
14.7.3.1	Displaying an object on a chart.....	14-76
14.7.3.2	Deleting an object	14-76
14.7.3.3	Deleting objects collectively from an object list.....	14-77
14.8	Updating a Chart Manually (S-57/S-63/C-MAP)	14-78
14.8.1	Displaying the Manual Update submenu	14-79
14.8.2	Selecting a chart to be updated	14-81
14.8.2.1	Displaying a chart list for the C-MAP chart	14-82
14.8.2.2	Searching the position that is clicked on with the cursor	14-82
14.8.2.3	Searching a chart with the chart name	14-83
14.8.2.4	Absence/expiration of the C-MAP chart license.....	14-83
14.8.3	Updating a chart manually	14-83
14.8.4	Displaying selected chart only	14-83
14.8.5	Entering an editor of the manual update	14-84
14.9	How to Use the Map Creation Tools (at Manual Update of S-57/S-63/C-MAP)	14-85
14.9.1	Deleting or hiding an object	14-85
14.9.2	Selecting an object type.....	14-86
14.10	Creating an Object(S-57/S-63/C-MAP).....	14-87
14.10.1	Creating a symbol object (Symbol).....	14-88
14.10.1.1	Creating an object by specifying the latitude and longitude.....	14-89
14.10.1.2	Creating an object with EBL/VRM operation.....	14-89
14.10.2	Creating a simple line and Alerts line (Line object).....	14-91
14.10.2.1	Creating a vertex by entering the position	14-94
14.10.2.2	Creating an object with EBL/VRM operation.....	14-94
14.10.3	Creating a circle, ellipse, and an arc (Line object).....	14-95
14.10.3.1	Creating an object by specifying a position for the center and size of the object.....	14-97
14.10.4	Creating a polygon and Alerts area (Area object).....	14-98
14.10.4.1	Creating a vertex by entering the position	14-100
14.10.4.2	Creating an object with EBL/VRM operation.....	14-101
14.10.5	Creating circle, ellipse, and fan areas (Area object).....	14-102
14.10.5.1	Creating an object by specifying the center position and the object size	14-104
14.10.6	Creating a text (Text object).....	14-105

14.10.6.1	Creating a text by specifying the latitude and longitude.....	14-106
14.10.6.2	Creating a text with EBL/VRM operation	14-106
14.10.6.3	Editing a text.....	14-107
14.10.6.4	Editing a template	14-107
14.10.6.5	Changing a text angle	14-109
14.10.7	Creating an arrow (Line object)	14-110
14.10.7.1	Creating an object by specifying the starting point/ending point position coordinates.....	14-111
14.10.7.2	Drawing an object with EBL/VRM operation	14-112
14.10.8	Property of a Sounding object	14-113
14.10.9	Editing attributes of an object	14-114
14.10.9.1	Type E	14-114
14.10.9.2	Type L.....	14-115
14.10.9.3	Type F	14-115
14.10.9.4	Type I.....	14-116
14.10.9.5	Type A/S	14-116
14.10.10	Highlighted display of an object	14-117
14.10.11	Reviewing manual update.....	14-120
14.10.12	Object Delete function.....	14-124
14.10.13	Object Remove function.....	14-125
14.11	Displaying a Pick Report of Manual Update Objects	14-126
Section 15	Logbook.....	15-1
15.1	Browsing a Logbook.....	15-1
15.1.1	Event detail information	15-3
15.2	Editing a Logbook	15-5
15.2.1	Adding an event.....	15-5
15.2.2	Editing event detail information.....	15-6
15.3	Outputting Event Data.....	15-7
15.3.1	Outputting a logbook as a file	15-7
Section 16	Setting up Screen View	16-1
16.1	Setting Chart Display Mode (Multi View Mode) (ECDIS only)	16-3
16.1.1	Setting Multi-Screen.....	16-3
16.2	Setting Screen Display Options	16-4
16.2.1	Setting up the display of Own Ship symbol	16-7
16.2.2	Setting up the display of ECDIS own ship's track.....	16-11
16.2.3	Setting up the display of RADAR own ship's track	16-13
16.2.4	Setting up the display of Route Monitoring	16-15
16.2.5	Changing the color of the alternative route.....	16-17
16.2.6	Setting up the display of User Chart.....	16-18
16.2.7	Setting up the display of Mariner's Mark/Line.....	16-20
16.2.8	Setting up Radar Overlay and Transparency of Echo/Trails	16-21

16.2.9	Setting up the display of TT/AIS Target	16-22
16.2.10	Setting up the display of Other Ship's Track.....	16-25
16.2.11	Setting up the display of Chart Common.....	16-30
16.2.12	Setting up the display of RADAR Chart.....	16-39
16.2.13	Setting up the display of ECDIS Chart.....	16-42
16.2.14	Setting up AIO/T&P display	16-52
16.2.15	Set display of danger detection highlight.....	16-53
16.2.16	Setting up the display of range/bearing measurement function	16-54
16.2.17	Setting up the display of Unit of Setting Value.....	16-55
16.2.18	Setting up display of Own Ship Track Control, display format of Own Ship/Cursor Position and display of Sub-Information dialog	16-57
16.2.19	Setting up the Water Depth display	16-58
16.2.20	Setting up the Rudder graph.....	16-59
16.2.21	Setting up the Gyro/Rudder graph.....	16-60
16.2.22	Setting up the Engine Graph	16-61
16.2.23	Setting up the graph range of the ROT slide bar.....	16-62
Section 17	Setting up Alerts	17-1
17.1	Selecting Setting Items	17-1
17.1.1	Displaying the [Alert] dialog box	17-1
17.1.2	Selecting a setting item.....	17-2
17.2	Collision Avoidance Alert Generation Conditions.....	17-4
17.2.1	Setting the CPA/TCPA limit values	17-4
17.2.2	Setting the status of the AIS target that is targeted for lost warning.....	17-5
17.3	New Target Warning Generation Conditions.....	17-6
17.3.1	Switching AZ1/AZ2 to enable/disable	17-7
17.3.1.1	Enabling AZ1 or AZ2	17-7
17.3.1.2	Disabling AZ1 or AZ2	17-7
17.4	Depth/Safety Contour Alert Generation Conditions	17-8
17.5	Setting Up Look-ahead	17-10
17.5.1	Switching to enable/disable a danger detection vector/sector	17-11
17.5.2	Setting up the size of a danger detection vector	17-11
17.5.3	Setting up the size of a danger detection sector	17-11
17.6	Special Condition Area Generation Conditions.....	17-12
17.7	Position Integrity Check Conditions	17-14
17.7.1	Setting up the condition of the Position Integrity Check	17-14
17.7.2	Setting up the generation condition of the HDOP exceeded Maintenance Information	17-15
17.8	Setting up Alert Processing.....	17-16
Section 18	Setting up the Operation Mode.....	18-1
18.1	Basic Operation of the [Settings] Dialog Box.....	18-1
18.2	Basic Settings for Radar Signal Processing	18-4

18.3	Setting Radar Signal Processing	18-6
18.4	Presetting Each Observation Scene	18-8
18.5	Setting Other Ship's Radar Trails	18-14
18.6	Setting Radar Antennas	18-15
18.6.1	Setting radar antennas	18-15
18.7	Setting Associations	18-16
18.8	Setting Own Ship's Dynamic Trait	18-18
18.9	Setting Operation Tests	18-19
18.10	Setting AIS/TT Filters	18-21
18.11	Setting the Target Track Function to ON/OFF	18-23
18.12	Setting Parameter Values at Route Plan Creation	18-24
18.13	Setting Automatic Sailing Parameter Values	18-26
18.14	Setting the Temporary Route Setting Values	18-29
18.15	Setting Chart Operation	18-31
18.16	Setting Logbook	18-34
18.17	Setting NAVTEX	18-37
18.18	Setting Navigation Equipment	18-42
18.19	Setting Colors and Brightness	18-43
18.20	Setting Sounds	18-47
18.21	Setting Key Assignment	18-49
18.22	Setting Preferences Information	18-53
18.23	Setting Screen Capture	18-64

Section 5 Basic Operation of the Radar

CAUTION



Use the radar as your navigation aid.

Final decision on the ship operation must be made by the ship operator himself.

If you depend entirely on the radar information for the final decision on the ship operation, such an accident as collision and stranding may occur.



If momentary power interruption has occurred on the ship during the radar operation, the image may distort or may not appear. If this occurs, turn on the power again.

5.1 Overview Flowchart

CAUTION



- Do not put anything on the operation section.
In particular, if a hot object is placed on the operation section, deformation is likely to occur.
- Do not allow a heavy impact to be applied to the operation section, trackball or dial.
A trouble may occur.

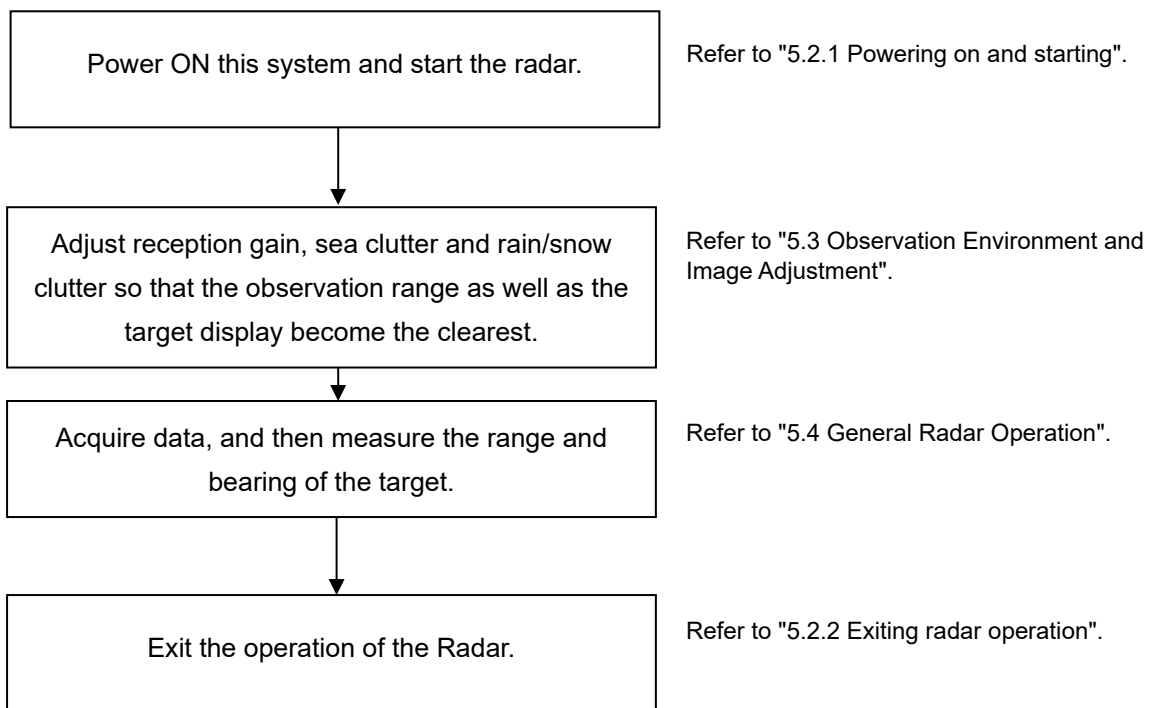

5.2 Starting and Shutting Down the Radar

5.2.1 Powering on and starting

Note

- Wait for about 2 seconds before turning on the power again.
- Immediately after the radar is installed, at start of the system after it has not been used for a long time, or after the magnetron is replaced, preheat the equipment in the standby state for 20 to 30 minutes before setting it into the transmit state.
If the preheating time is short, the magnetron causes sparks, resulting in its unstable oscillation.
- Start transmission on a short pulse range and change the range to the long pulse ranges in turn. If the transmission is unstable in the meantime, immediately place the system back into the standby state and maintain it in the standby state for 5 to 10 minutes before restarting the operation. Repeat these steps until the operation are stabilized.

1 Check that the ship's mains are turned on.

2 Press the Power button on the operation unit.

This equipment starts and Task Menu appears on the screen.

3 Click on the [Collision Avoidance (RADAR)] button on Task Menu.

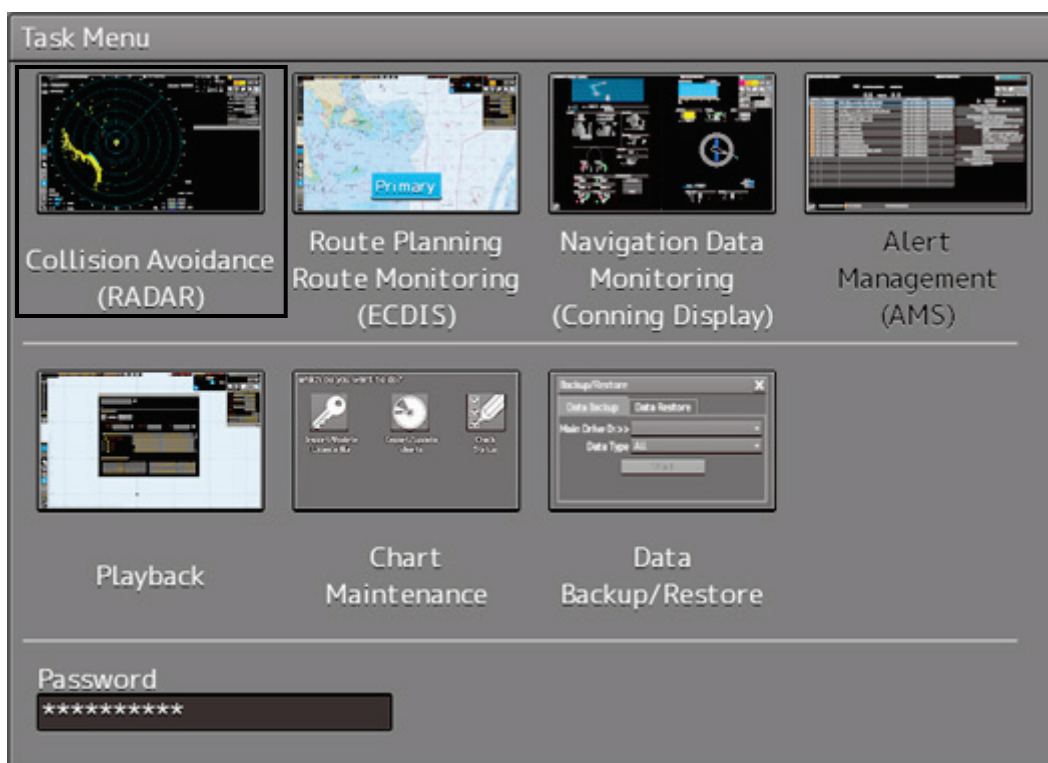

The RADAR screen appears.

The preheating time is displayed at the center of the screen.



When the magnetron radar antenna is connected, "Preheat" is displayed on the Standby/Send switching button.

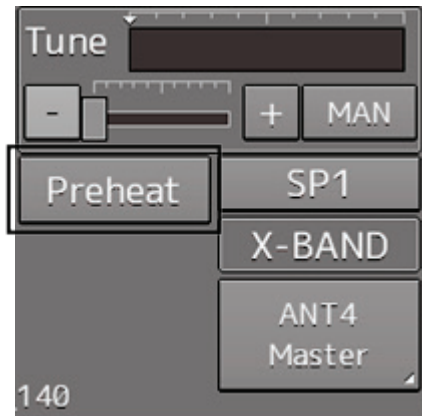

4 Wait until preheating is complete.

When the preheating time expires, the preheating time display disappears, and the display of the Standby/Transmit switch button changes from "Preheat" to "Standby".

5 Click on the Standby/Transmit switch button.

Radar transmission starts and the radar antenna rotates.

The display of the Standby/Transmit switch button changes from "Standby" to "Transmit".

Note

Even if the Standby/Transmit switch button is clicked on while "Preheat" is being displayed, radar transmission cannot be performed.

5.2.2 Exiting radar operation

1 Click on the Standby/Transmit switch button in Radar system information.

Radar transmission stops and the rotation of the radar antenna stops.

The display of the Standby/Transmit switch button changes from "Transmit" to "Standby".

Memo

If observation using the radar is being scheduled within a comparably short period of time, keep this state. Observation can be started immediately by just clicking on the Standby/Transmit switch button.

2 Press the Power button on the operation unit.

The power to this equipment is turned OFF.

WARNING



Before starting maintenance, turn off power. Cut off all the power supplies to the equipment.

Some equipment components can carry electrical current even after the power switch is turned off, and conducting maintenance work may result in electric shock, equipment failure, or accidents.



When turning off the power supply, do not hold down the power button of the operation unit.

Otherwise, a trouble may occur due to termination failure.

5.3 Observation Environment and Image Adjustment

5.3.1 Adjusting screen brightness

1 Adjust the screen brightness.

For the details of the adjustment, refer to "3.9 Adjusting the Brightness of the Screen and Operation Unit".

In consideration of the ambient brightness, adjust the brightness of the display that is high enough to easily observe the radar display but does not glare.

5.3.2 Changing the observation range

1 Click on the Range Scale button in Presentation and mode information, and then select Range from the pop-up menu.

Range Scale button

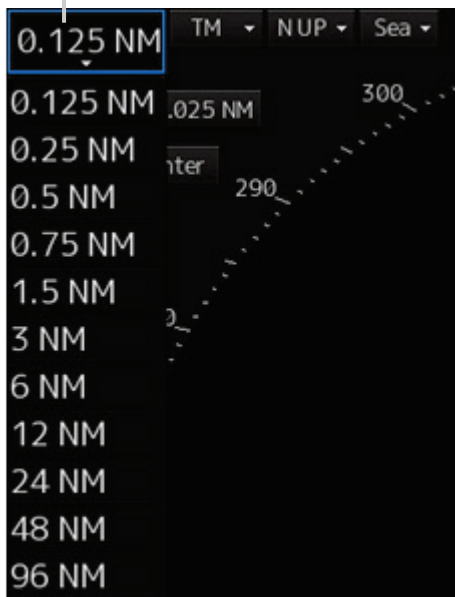

[Points on adjustments]

Increasing the observation range will enable a wider range to be observed.

However, a video image is small and the ability to detect targets near own ship decreases. Therefore, when observing the vicinity of own ship, use the smaller observation range.

Decreasing the observation range will enable the vicinity of own ship to be enlarged. However, caution must be taken because video images of the area beyond the observation range cannot be displayed.

CAUTION



Since the image within the previous observation range is displayed by expanding/contracting for the period from immediately after switching of the observation range from the next image updating, do not use this image for navigation.

If this image is used for navigation, an accident may occur.

Note

An observation range under which the own ship display position and the antenna position exceeds the area 66% of the screen radius cannot be selected.

5.3.3 Adjusting tune

CAUTION



Normally, use the automatic tune mode.
If you use the manual tuning mode, an accident may be caused by fluctuation of transmission and reception.
Use the manual tune mode only when best tuning is not possible in the automatic tune mode due to deterioration of magnetron.

This equipment has the automatic tuning mode that performs tuning of the transmission frequency and the reception frequency by automatic control, and the manual tuning mode in which the user performs tuning. Normally use the automatic tune mode. Only when the best tuning is not possible by the automatic tune mode due to the deterioration of magnetron, use the manual tune mode. The tuning mode currently being used is displayed on the Tuning Mode button in Radar system information.

Note
This function is effective when a magnetron radar antenna is connected.

When using the automatic tune mode

- 1 Click on the tune mode button.**
[AUTO] (automatic) is displayed on the tune mode button.
Whenever the button is clicked on, the mode is switched between [AUTO] (automatic) and [MAN] (manual).

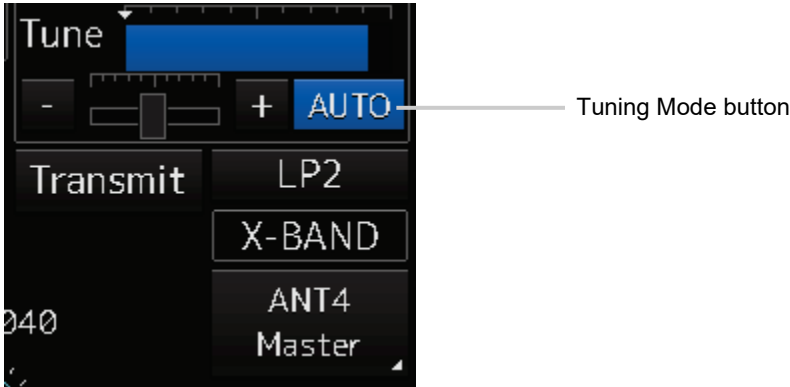

Using the manual tune mode

1 Click on the tune mode button.

[MAN] (manual) is displayed on the tune mode button.

Each time this button is clicked on, the display switches between [AUTO] (automatic) and [MAN] (manual).

2 Move the fine tuning slider to the left and right sides.

The tuning status is displayed on the tuning bar according to the movement of the fine tuning slider.

Make adjustments so that the display on the tuning bar indicates the maximum (the state in which the tuning bar is positioned at the most right).

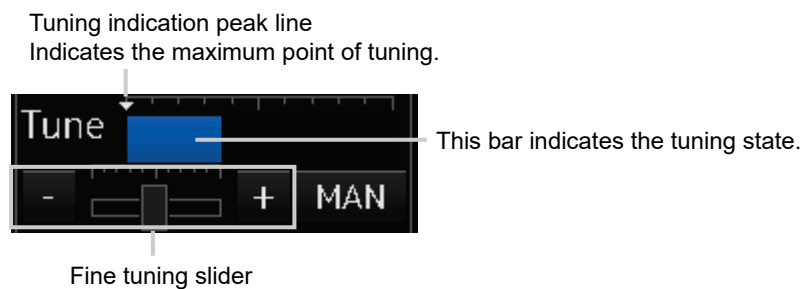

5.3.4 Adjusting gain

CAUTION



Be sure to always adjust for the best gain.

If the gain is too high, undesired signals including receiver noise and false echoes increase resulting in reduction of visibility of targets.

Otherwise, accidents may result.

On the contrary, if the gain is too low, targets including ships and dangerous objects may not be clearly indicated.

Adjust the gain of the radar.

Memo

Set the optimum gain when making adjustments, giving consideration to the setting described in "5.3.7 Adjusting to optimal images (Selection of observation scenes)".

- 1 Drag the [Gain] (reception gain adjustment) slider dial in Radar signal information, turn the trackball, and set up reception gain.

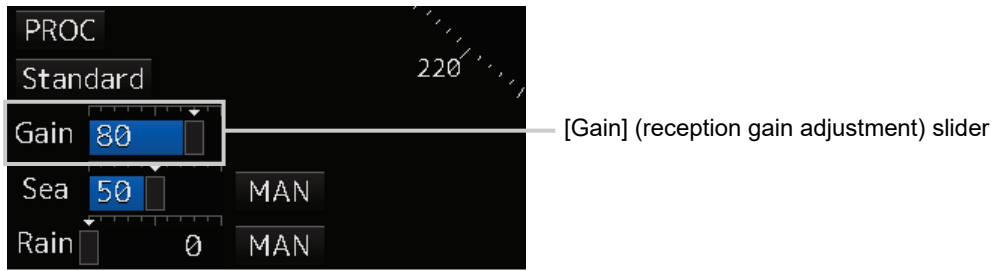

Moving the slider to the right increases gain.
Moving the slider to the left decreases gain.
The current reception gain level is indicated by the bar and a numeric value.

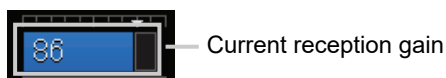

[Points on adjustments]

As reception gain is increased, the range in which radar images can be observed widens; however, if gain is increased too high, receiver noise, false echoes and other undesired signals will increase on the screen, lowering the visibility of targets.

Also, it gets easier to see the screen display if gain is decreased to observe cluttered targets and close range, but be careful not to overlook small targets.

Memo

If the optimal setting value was lost, it is recommended to reset to the initial value and tune up again.

The initial setting value is indicated as shown in the figure at right.

Initial setting value



5.3.5 Rejecting sea clutter (Sea)

CAUTION



Never set the sea clutter suppression function before rejecting all the sea clutters at close range. Detection of not only echoes from the wave and so on but also targets such as other ships or dangerous objects may be suppressed.

When using the sea clutter suppression function, make sure to choose the most appropriate setting for suppression.

Memo

Remove images by sea clutter by using the sea clutter suppression function.

When using the sea clutter suppression function, make the optimum setting, giving consideration to the setting described in "5.3.7 Adjusting to optimal images (Selection of observation scenes)".

- 1 Drag the [Sea] (sea clutter adjustment) slider dial in Radar signal information, turn the trackball, and adjust the amount of images by sea clutter displayed on the screen so as to make display easy to observe.

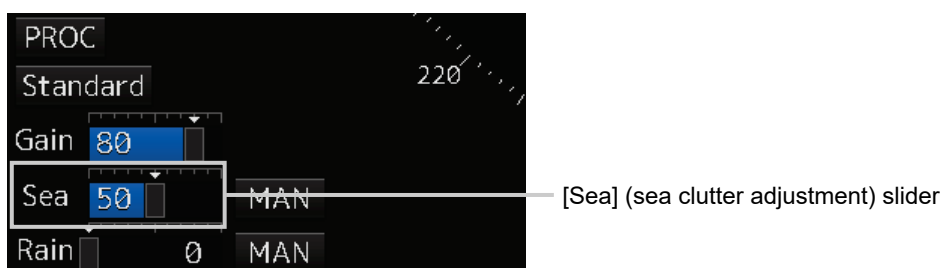

Moving the slider to the right decreases the amount of images by sea clutter.

Moving the slider to the left increases the amount of images by sea clutter.

The current level of sea clutter suppression is indicated by the bar and a numeric value.

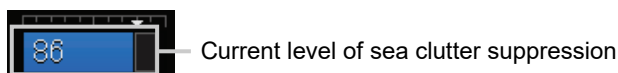

[Points on adjustments]

The sea clutter suppression function decreases the amount of images by sea clutter by lowering reception gain at close range. When reception gain is lowered, the effectiveness of sea clutter suppression increases; however, if excessive effect is applied, please note that targets having weak signal strength such as buoys and small ships will disappear.

Memo

If the optimal setting value was lost, it is recommended to reset to the initial value and tune up again.

The initial setting value is indicated as shown in the figure at right.

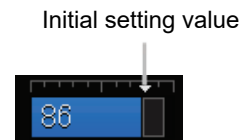

Using the function of automatic sea clutter suppression mode

The sea clutter suppression in accordance with the intensity of sea clutter is possible. Use this mode when the sea clutter's intensity differs according to directional orientation.

1 Click on the Automatic Sea Clutter Suppression button.

[AUTO] (automatic) is displayed on the automatic sea clutter suppression button.

Each time this button is clicked on, the display switches between [AUTO] (automatic) and [MAN] (manual).

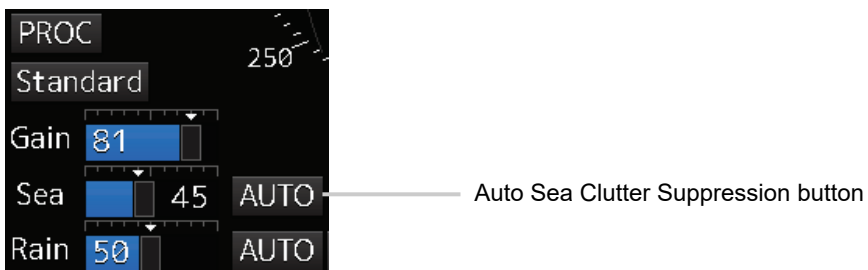

2 Drag the sea clutter adjustment slider dial, turn the trackball, and adjust the amount of images by sea clutter displayed on the screen.

Even while automatic sea clutter is being suppressed, the amount of images can be fine-adjusted manually.

Canceling automatic sea clutter suppression

1 Click on the Automatic Sea Clutter Suppression button.

[MAN] (manual) is displayed on the automatic sea clutter suppression button.

Each time this button is clicked on, the display switches between [AUTO] (automatic) and [MAN] (manual).

5.3.6 Rejecting rain/snow clutter

CAUTION



Never set the rain/snow clutter suppression function too high. Detection of not only echoes from the rain or snow but also images targets such as other ships or dangerous objects may be suppressed. When using the rain/snow clutter suppression function, make sure to choose the most appropriate setting for suppression.

Memo

Remove images by rain/snow clutter by using the sea clutter suppression function. When using the rain/snow clutter suppression function, make the optimum setting giving considering to the setting described in "5.3.7 Adjusting to optimal images (Selection of observation scenes)".

- 1 Drag the [Rain] rain/snow clutter adjustment slider dial in Radar signal information, turn the trackball, and adjust the amount of images by rain/snow clutter displayed on the screen so as to make display easy to observe.

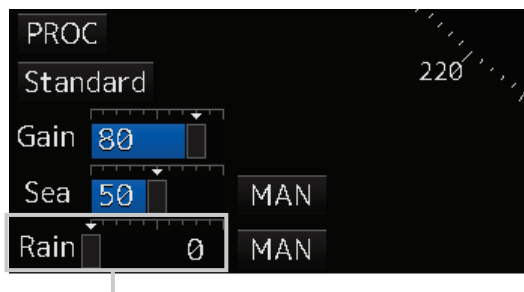

[Rain] (rain/snow clutter adjustment) slider

Moving the slider to the right decreases the amount of images by rain/snow clutter.
 Moving the slider to the left increases the amount of images by rain/snow clutter.
 The current level of rain/snow clutter suppression is indicated by the bar and a numeric value.



Current level of rain/snow clutter suppression

[Points on adjustments]

When the amount of images by rain/snow clutter is decreased, the outlines of targets hidden by images of rain/snow will appear, but please note that small targets may be missed. Since this can also reduce sea clutter, it is effective to use it together with the sea clutter rejection function.

Normally, set the level of rain/snow clutter suppression to 0.

Memo

If the optimal setting value was lost, it is recommended to reset to the initial value and tune up again.

The initial setting value is indicated as shown in the figure at right.

Initial setting value

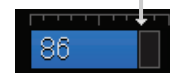

Using the automatic rain/snow clutter suppression mode

The rain/snow clutter suppression in accordance with the intensity of rain/snow clutter is possible. Use this mode when the rain/snow clutter's intensity differs according to directional orientation.

1 Click on the Automatic Rain/Snow Clutter Suppression button.

[AUTO] (automatic) is displayed on the automatic rain/snow clutter suppression button.

Each time this button is clicked on, the display switches between [AUTO] (automatic) and [MAN] (manual).

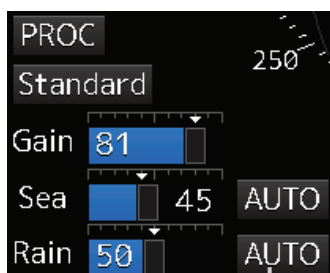

Auto Rain/Snow Clutter Suppression button

2 Click the left mouse button of the button on the [Rain] (rain/snow clutter adjustment) slider, drag it with the trackball, and adjust the volume of the echo created by rain/snow clutter that is displayed on the screen.

Even while auto rain/snow clutter is being suppressed, the amount of images can be fine-adjusted manually.

Canceling automatic rain/snow clutter suppression

- 1 Click on the Automatic Rain/Snow Clutter Suppression button.

[MAN] (manual) is displayed on the automatic rain/snow clutter suppression button.

Each time this button is clicked on, the display switches between [AUTO] (automatic) and [MAN] (manual).

5.3.7 Adjusting to optimal images (Selection of observation scenes)

To obtain optimal images, it is necessary to understand the features of radar signal processing settings and perform adjustment according to the sea condition. When adjusting all setting values manually, such adjustment may sometimes difficult even for experienced operators.

Thus, signal processing settings suitable for general usage are preset in the observation scene selection function at the time of factory shipment. In many cases, optimal images can be obtained quickly by selecting the observation scene corresponding to the current sea condition.

- 1 Click on the Observation Scene Selection button in Radar signal information.

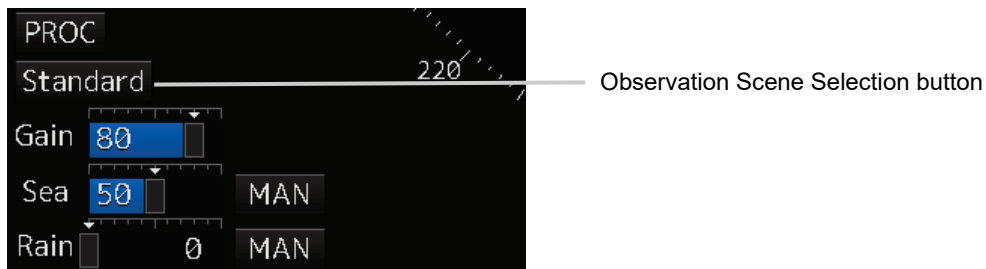

The [Observation Scene Selection] dialog is displayed.

2 Select the observation scene corresponding to the current sea condition

Refer to the following table about the definitions of observation scene.

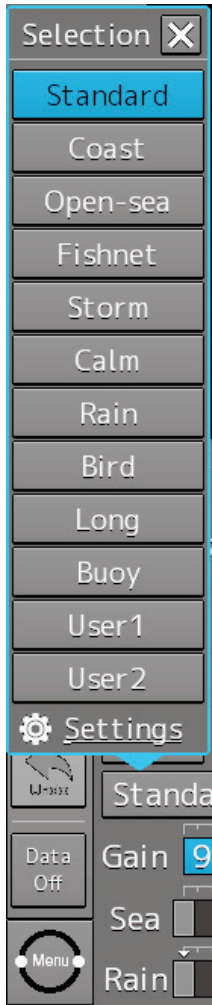

Observation Scene	Definition
Standard	Standard
Coast	Coastal navigation Use this scene to monitor a relatively short range, for example, bays and coasts where many boats and ships are running. (Importance is attached to resolution.)
Open-sea	Open-sea navigation Use this scene to monitor a relatively long range, for example, the open-sea. (Importance is attached to long range gain)
Fishnet	Fishnet Use this scene to detect small targets such as fishnets of round haul netters hidden by sea clutter returns. (Importance is attached to sea clutter suppression, and gain to moving targets lowers.)
Storm	Storm Use this scene when many rain/snow clutters or sea clutter are detected in stormy weather. (Importance is attached to rain/snow clutter and sea clutter suppression, and gain slightly lowers.)
Calm	Calm Use this scene when only a few rain/snow clutter or sea clutter are detected.
Rain	Rain Use this scene when sea clutter is not strong but rain/snow clutter is strong. (Importance is attached to rain/snow clutter suppression, and gain slightly lowers.)

Observation Scene	Definition
Bird	Bird Use this scene to detect a flock of sea birds.
Long	Long distance detection Use this scene to monitor utmost distances in the broad ocean.
Buoy	Buoy Use this scene to detect small targets such as radio buoys outside of sea clutter. (Targets having low detection probability are displayed.)
User1	User 1 General scene used when the nine scenes above are not applicable.
User2	User 2 General scene used when the nine scenes above are not applicable.

3 Adjust [Gain], [Sea] and [Rain] as necessary.

Note

When the setting value among the observation scene is changed from the initial value, underline is displayed for the observation scene selection button and a button corresponding to the [Selection] (observation scene selection) dialog is displayed.

Memo

If the optimal setting value was lost, it is recommended to reset to the initial value and tune up again.

The initial setting value is indicated as shown in the figure at right.

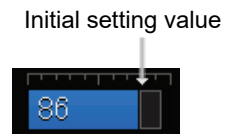

5.4 General Radar Operation

5.4.1 Interference Rejection (IR Function)

By setting IR (Interference Rejection) function, Interference by other radars is rejected.

Note

To observe the radar beacon and the SART signal, IR processing may occasionally suppress these images, so set IR to Off (interference rejection function OFF).

- 1 Click on the **RADAR Signal Processing Setting** button in Radar signal information.

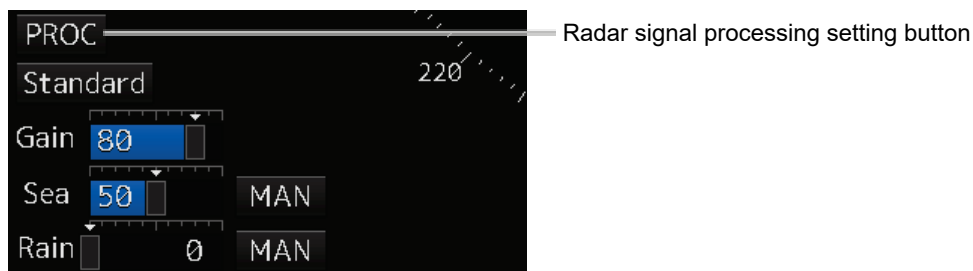

The [RADAR Process] dialog box appears.

- 2 Click on [IR] and then select the interference rejection level from the list.

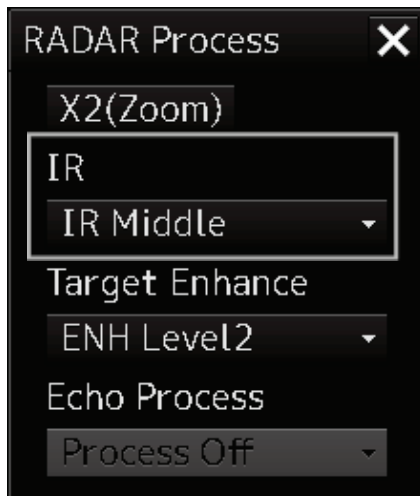

Setting items	Functions and effects
[Off]	Sets the IR function to Off.
[IR Low]	Sets the IR level to the low level.
[IR Middle]	Sets the IR level to the middle level.
[IR High]	Sets the IR level to the high level.

[Points on setting]

When a high interference rejection level is selected, the radar's ability of detecting small targets such as buoys and small boats is lower.

In general, [IR Low] should be selected.

5.4.2 Changing the transmitter pulse length

- 1 Click on the Transmitter Pulse Length switch button in Radar signal information.

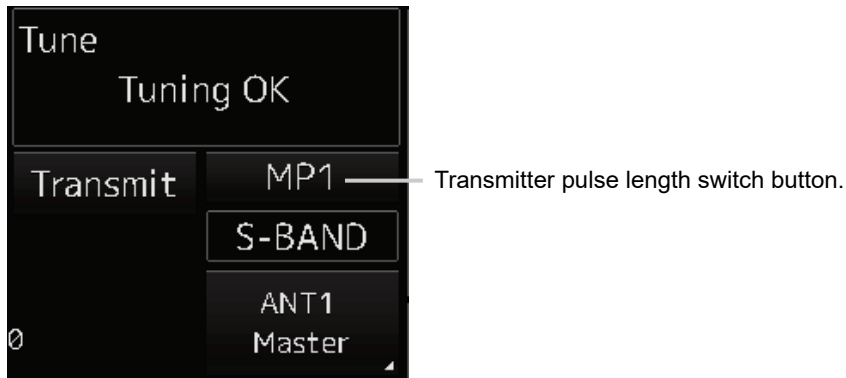

Each time this button is clicked on, the transmitter pulse length changes.

Example: [MP1] → [MP2] → [LP1] → [LP2]



Transmitter pulse length	Functions and effects	Recommended condition for selection
[SP]	<ul style="list-style-type: none"> The transmitter pulse becomes shorter, and the range resolution improves. The effect of suppressing sea clutter and rain/snow clutter improves. 	In bays/harbors where targets are densely crowded Rough sea state due to torrential rain or stormy weather
[MP]	<ul style="list-style-type: none"> The normal transmitter pulse length is set. Both range resolution and gain are appropriately set. 	General navigation
[LP]	<ul style="list-style-type: none"> The transmitter pulse becomes longer, and gain improves. Small targets are zoomed and are easy to observe. When the sea state is bad, detection performance decreases. 	Detection of small targets in good weather conditions

Memo

Usable transmitter pulse length differs according to the type of radar antenna being used and the observation range being used.

5.4.3 Enhancing targets

This function enlarges the display sizes of images to enhance targets.

- 1 Click on the **RADAR Signal Processing Setting** button in Radar system information.

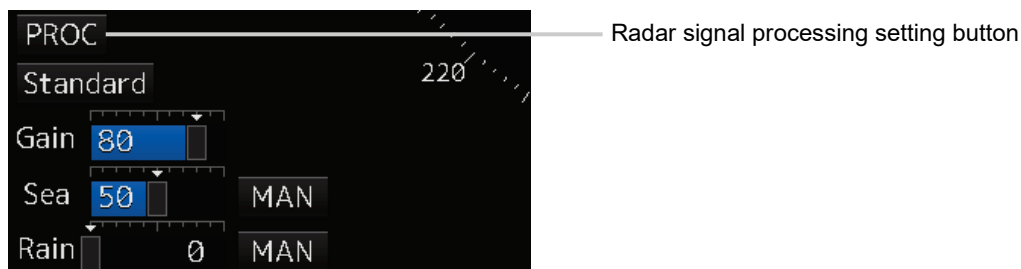

The [RADAR Process] dialog box appears.

- 2 Select the target enhancement level from the list in [Target Enhance].

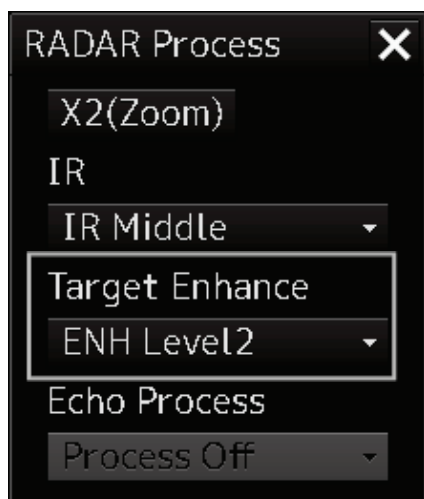

Setting items	Functions and effects	Recommended use condition
[ENH Off]	Sets the target enhancement function to OFF.	Set this function to Off when resolution is particularly necessary.
[ENH Level1]	Enhances the radar echo by 1 level in the vertical and horizontal directions of the screen.	Normal navigation
[ENH Level2]	Enhances the radar echo by 2 levels in the vertical and horizontal directions of the screen.	Enhance the visibility of the radar image
[ENH Level3]	Enhances the radar echo by 3 levels in the vertical and horizontal directions of the screen.	Detect small targets such as buoys

[Setting points]

When [ENH Level3] is selected, sea clutter and rain/snow clutter are apt to be enlarged. To use, suppress images of sea clutter and rain/snow clutter using the [Sea] (sea clutter adjustment) slider and the [Rain] (rain/snow clutter adjustment) slider.

In general, [ENH Level1] or [ENH Level2] should be selected.

5.4.4 Using video processing (Echo Process)

This function reduces undesirable noise and enhances targets.

Note

- When viewing a radar beacon, SART signal, or fast moving target on the radar display, select [Process Off] (video process off).
- If video processing mode is set to [CORREL], a high speed target is less-visible .

- 1 Click on the **RADAR Signal Processing Setting** button in Radar signal information.

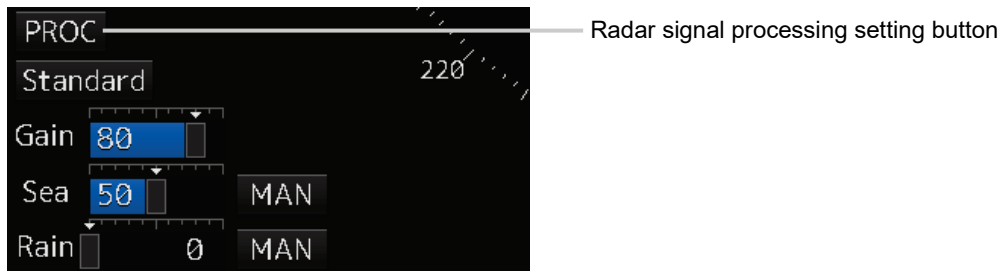

The [RADAR Process] dialog box appears.

- 2 Select the video process mode from the list in [Echo Process].



Setting items	Effects and recommended use conditions
[Process Off]	Sets the image processing function to Off.
[3 Scan CORREL]	Use when the rain/snow clutter images are heavy.
[4 Scan CORREL]	Use when enhancing the target while suppressing sea clutter images.
[5 Scan CORREL]	Use when detecting small targets in sea clutter images.
[Remain]	Use when own ship is rolling severely.
[Peak Hold]	Use for detection of small targets of low detection probability.

5.4.5 Setting the azimuth mode

Set the bearing for the radar video to be displayed on the radar display.

- 1 Click on the Azimuth mode combo box in Presentation and mode information.



- 2 Select the Azimuth mode.

Note

Available combinations vary depending on the settings of the azimuth mode and the motion mode (refer to "5.4.6 Setting a motion mode").

Azimuth mode \ Motion mode	N UP	H UP	C UP	W UP	C UP (Angle Setting)
TM	○	×	○	×	○
RM(T) or RM(R)	○	○	○	○	○

The following azimuth modes can be set.

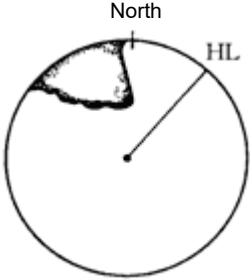
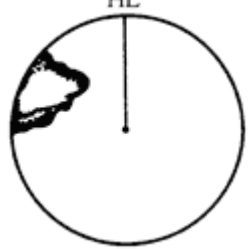
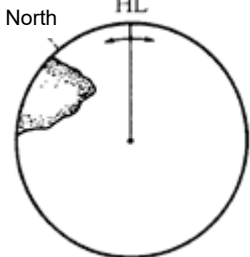
Setting items	Description	Display image
[N UP]	<p>North UP (North Up)</p> <ul style="list-style-type: none"> The video is displayed so that the zenith of the PPI points to the due north. Fixed targets do not flicker and are easily identified on the chart, and the true bearing of a target can easily be read out. 	
[H UP]	<p>Head UP (Head Up)</p> <ul style="list-style-type: none"> The video is displayed so that the ship's heading line is displayed at the top of the screen. Since targets are displayed in their directions relative to the ship's heading line, the operator can view the video in the same field of view as in operating the ship at sea. Therefore, This mode is suitable for watching over other ships This is not available for TM (True Motion) mode. 	
[C UP]	<p>Course UP (Course Up)</p> <ul style="list-style-type: none"> At the setting of Course Up, the ship's heading (HDG) is fixed and displayed immediately above the screen. Similar to true bearing display, the positions of stationary targets will not deviate even if yawing occurs in the ship: targets are displayed stably and the bearing of the heading line moves only according to the amount of change in own ship's course. To change the course, select the Course UP display by clicking on the Azimuth mode combo box several times. A course can be set again. 	
[W UP]	<p>Way Point UP (Waypoint Up)</p> <ul style="list-style-type: none"> The destination is displayed at the top of the screen. 	
[C UP (Angle Setting)]	<p>Course UP by angle setting (Course Up by angle setting)</p> <ul style="list-style-type: none"> When C UP is selected, the [C UP (Angle Setting)] dialog box is displayed. The course angle that is set in the dialog box is displayed by being fixed at the top of the screen. <div data-bbox="416 1617 810 1800" style="border: 1px solid black; background-color: #333; color: #eee; padding: 5px; margin: 10px 0;"> <p>C UP (Angle Setting) ✕</p> <p style="text-align: center;">Angle 123.3 °</p> <p style="text-align: center;">◀ [Slider] ▶</p> </div> <ul style="list-style-type: none"> Input the angle of the ship's heading in the [Angle] input box of the [C UP (Angle Setting)] dialog box. The angle can also be input (increase/decrease) by operating the angle input slider. After completing the setting, click on the [X] button. 	

5.4.6 Setting a motion mode

By setting a motion mode, the display method of the own ship's position on the radar screen can be changed.

Switching Relative Motion (RM) Mode to True Motion (TM) Mode

- 1 Click on the Motion Mode button in Presentation and mode information.



- 2 Click until the desired operating mode is reached.

Note

Available combinations vary depending on the settings of the motion mode and the azimuth mode (refer to "5.4.5 Setting the azimuth mode").

Azimuth mode \ Motion mode	N UP	H UP	C UP	W UP	C UP (Angle Setting)
TM	○	×	○	×	○
RM(T) or RM(R)	○	○	○	○	○

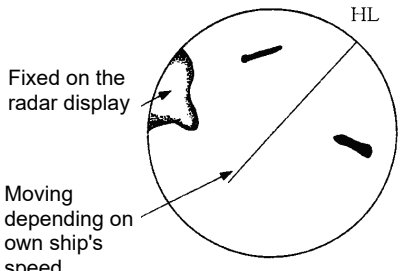
Setting items	Description	Display image
[TM]	<p>True Motion Mode (True Motion display)</p> <ul style="list-style-type: none"> In Ground mode, the own ship's display position moves according to the Speed Over the Ground (SOG) and fixed targets such as land are fixed on the radar screen. In Water mode, the own ship's display position moves according to the Speed Through Water (STW) and fixed targets such as land move according to the difference between the Speed Through Water (STW) and the Speed Over the Ground (SOG). When the own ship reaches to the true motion status, the own ship's position is set at the position of about 60% of the screen radius in direction opposite to the own ship's course by adding the influence of the tidal current. The ship's position starts to move according to the own ship's speed, course, and influence of the tidal current. When the own ship's position reaches the position of about 60% of the screen radius, the position is reset to the position of about 66% of the screen radius in the direction opposite to the own ship's course (COG) by adding the influence of the tidal current at that time. 	
[RM(T)] or [RM(R)]	<p>Relative Motion Mode (Relative Motion display)</p> <ul style="list-style-type: none"> Own ship is fixed at the center of the radar screen and fixed targets such as land move relatively. 	
[TM Reset]	<p>TM Reset</p> <ul style="list-style-type: none"> The own ship's position is reset in [TM] (true motion display) mode. For the details, refer to "5.4.6.1 Resetting Own Ship to its Initial Position in [TM] (True Motion display) Mode". 	

5.4.6.1 Resetting Own Ship to its Initial Position in [TM] (True Motion display) Mode

1 When the operation mode is TM, long pressing the left click.

Own ship is reset to its initial position as established when the relative motion mode is changed to the true motion mode. The ship starts moving from that position.

5.4.7 Setting the Stabilization Mode

- 1 Click on the **Stabilization Mode** button in **Presentation and mode information**

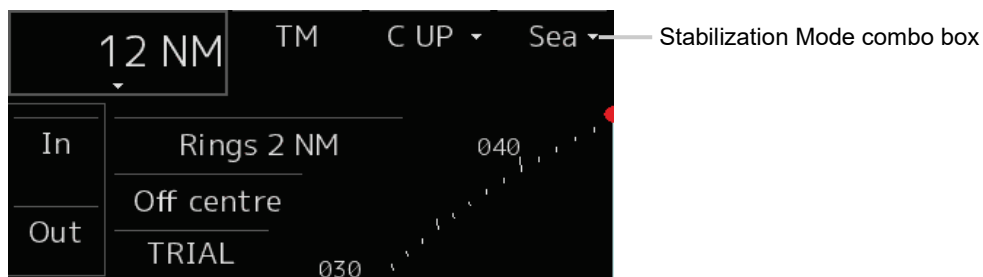

5

- 2 Select the **Stabilization Mode**.

[GND]: Use the ship speed relative to ground in the Stabilization Mode.

[Sea]: Use the ship speed relative to water in the Stabilization Mode.

5.4.8 Moving own ship's display position (Off Center)

The own ship's position can be moved from the display center to any position within 60% of the display radius. This function is convenient for observing a wide coverage in any direction.

Note

This function is not available on the 96 NM range.

- 1 Click on the **[Off Center]** button in **Presentation and mode information** to turn the **Off Center mode to "On"**.

The Off Center mode is switched to On/Off whenever the button is clicked on.

Off Center mode is On:



Off Center mode is Off:



The cursor mode is set to the Off Center mode.

2 Place the cursor on the position you want to move and click on it.

Own ship's display position will be moved to the clicked position.

Note

An own ship display position can be moved within the range in which the own ship display position and the antenna position do not exceed 60% of the screen radius.

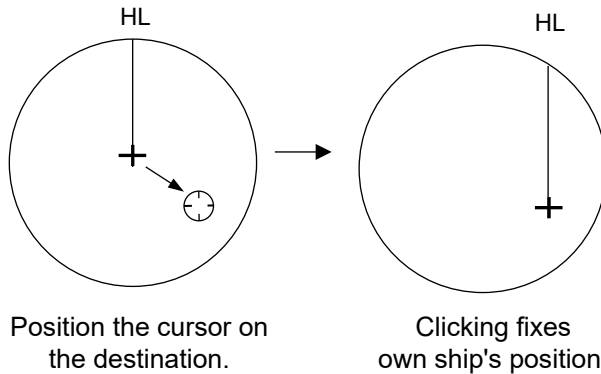

Returning own ship's position to the center of the display

1 Click on the [Off Center] button in Presentation and mode information to disable the Off Center mode.

The own ship position is returned to the center of the display (on relative motion) or the position to be reset (on true motion).

5.4.9 Displaying other ship's trails (Trails)

Other ships' movements and speeds can be monitored from the lengths and directions of their trails, serving for collision avoidance.

5.4.9.1 Trails motion mode

There are two types of trails: relative motion trail and true motion trail.

Relative motion trail:

The system plots the trails of a target at a position relative to the own ship. The operator can easily judge whether the target is approaching the own ship.

While the own ship is moving, the system also plots the trails of land and other fixed targets.

True motion trail:

The system plots the absolute motion trails of a target, irrespective of the own ship's position.

The operator can easily judge the course and speed of the target.

The system does not plot the trails of land and other fixed targets.

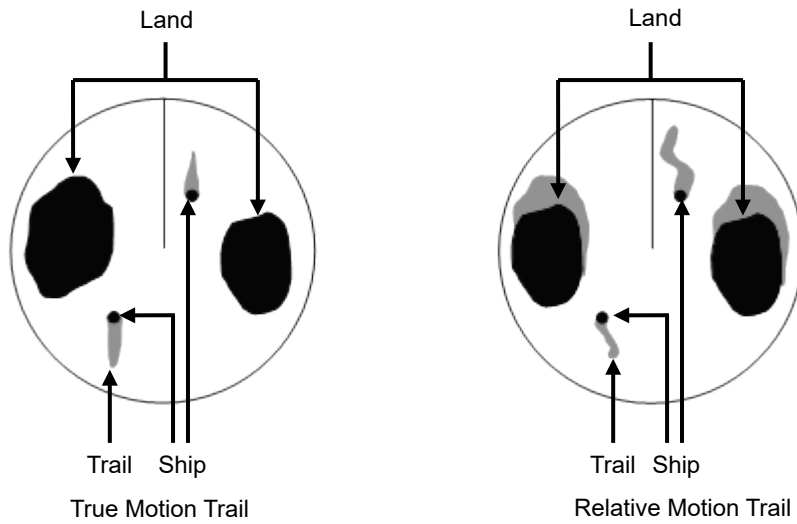

While the true motion trail mode is active, this equipment enables the continuous use of true motion trail even if any of the following operations is performed:

- Motion mode change (TM/RM)
- TM reset
- Azimuth mode change
- Off Center
- Chart display on/off (Chart)

Note

Accurate true bearing signals and speed signals are necessary for using the true motion trail mode.

5.4.9.2 Changing motion mode of trails

The trail display mode can be switched by using the Trail true/relative switching button of other ship information.

Note

The available trail motion modes vary depending of the motion mode that is set.

True motion display (TM): Only true motion trail is available.

Relative motion display (RM): Relative motion trail and true motion trail can be selected.

[RM(R)] is displayed when relative motion trail is used.

[RM(T)] is displayed when true motion trail is used.

1 Click on the Trails True/Relative switch button.

Each time this button is clicked on, the display mode of Trails switches between [T] and [R].

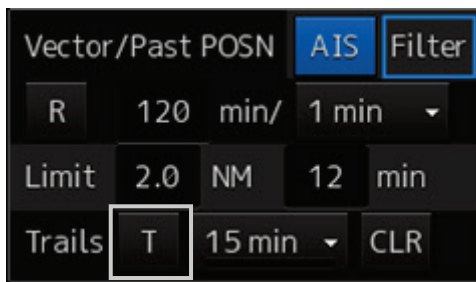

[T]: (True motion trail)

[R]: (Relative motion trail)

For the details of the motion mode of trails, refer to "5.4.9.1 Trails motion mode".

5.4.9.3 Setting the length of the trail

1 Click on the Trail Length switch combo box in [Trails] of other ships' information.

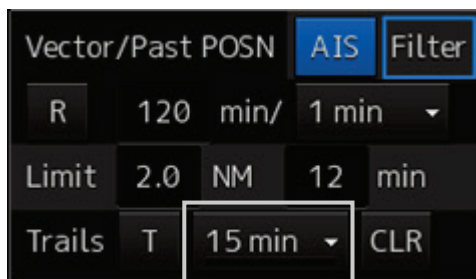

Select a radar trail length.

Short mode: Off, 15 sec, 30 sec, 1 min, 3 min, 6 min, 10 min, 15 min, 30 min, 60 min

Long mode: Off, 30 min, 1 hr, 2 to 24 hrs (at 1 hr interval from 1 to 24 hrs)

Memo

Saved trails cannot be erased even when the trail lengths are changed the Trail Length switch combo box.

Even after the trails display is turned off once, the past trails can be displayed traced back by setting a desired time. The plot of the trail starts when starting the transmission.

The system is plotting trails even while the trails display is off.

If only a short time has elapsed after the commencement of transmission, the display may not reach the specified value. The time not to reach is indicated by the length of the blue bar shown at the lower part of the Trail Length switch combo box.

5.4.9.4 Clearing trails data

- 1 Click on the [CLR] (clear trails) button.



The confirmation dialog box appears.

- 2 Click on the [OK] button.

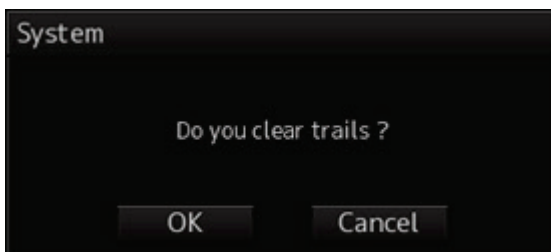

All the saved trails data will be cleared. The system starts plotting trails in initial state.

5.4.10 Doubling the size of radar image

This function doubles the size of radar video near a specified position.

Note

If the range is 0.125 NM and the motion mode is in the TM mode, this function is not available.

- 1 Click on the radar signal process setting button in Radar signal information.

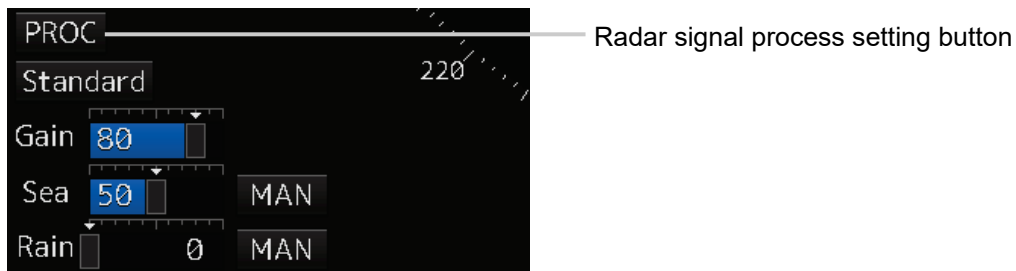

[RADAR Process] dialog box appears.

- 2 Click on the [X2(Zoom)] (double zoom) button.



Each time this button is clicked on, the double zoom function is switched On and Off.

On display: 

Off display: 

When double zoom is set, the cursor mode changes to the off-set cursor.

3 Place the offset cursor on a location you want to zoom and click on it.

Using the cursor position as the reference, the screen display is enlarged by a magnification of 2 so that the midpoint between the cursor and own ship's position comes at the center of the radar display.

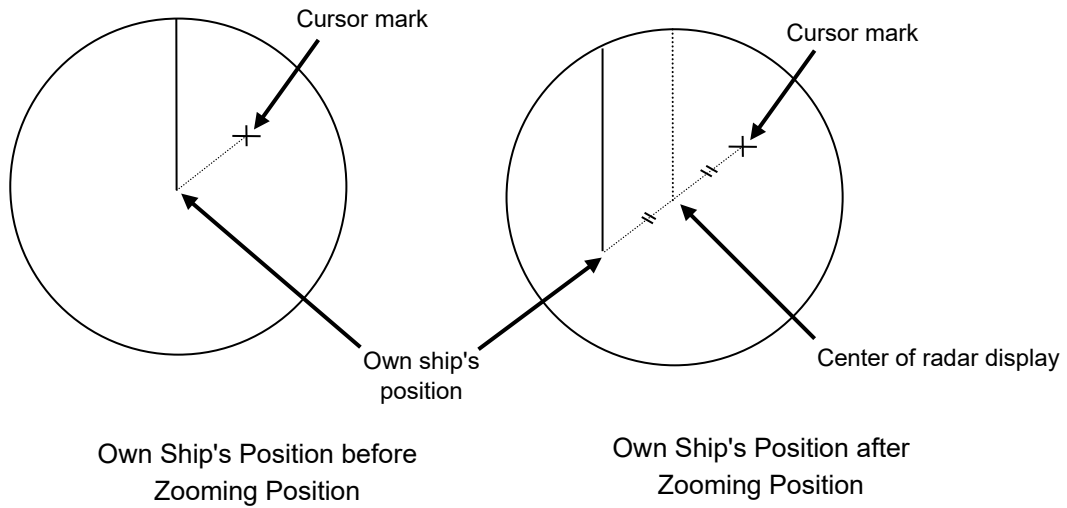

Canceling zoom display

1 Click on the [X2(Zoom)] button to turn the X2 Zoom function Off.

Off display: **X2(Zoom)**

5.4.11 Hiding the heading line (HL OFF)

- 1 The ship's heading line is hidden while the [HL Off] button is pressed down. When the button is released, the ship's heading line is redisplayed.



5.4.12 Hiding graphics information on radar display

On the radar screen of this equipment, various types of graphics information such as TT/AIS symbol, user chart, and chart information are displayed. When the visibility of the radar screen deteriorates due to excessive amount of graphic information displayed, the visibility of the screen can be improved by temporarily clearing the unnecessary graphic information by using this function.

- 1 While the [Data OFF] button on the left toolbar is being held down, graphic information other than the TT and AIS of danger targets, radar images, radar trails and cross cursors are hidden.**

When the button is released, graphics information is redisplayed.



5.4.13 Setting true bearing

When the GYRO I/F is used to enter a gyro signal, there is a rare case in which a true bearing value indicated by the master gyro does not match the true bearing value indicated by this equipment.

In that case, adjust the true bearing value of this system so that it matches the value indicated by the master gyro.

- 1 Click on the [Menu] button on the left toolbar.**
A menu is displayed.
- 2 Click [Settings] - [General] on the menu.**
The [General] dialog box appears.

- 3 Click on the input box of [GYRO Setting].

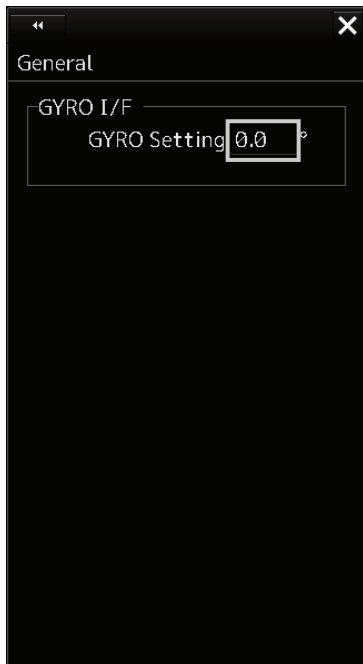

- 4 Input a master gyro value on the software keyboard.

5.4.14 Setting own ship speed

5.4.14.1 Switching own ship speed device

- 1 Select the ship speed device from the STW Source combo box in the own ship information.





- When using 1-axis log, heading speed component can be detected, but transverse speed component cannot be detected. Then leeway effect (component drifted by wind) cannot be detected.
- When using 2-axes ground log, its accuracy in shallow waters may be deteriorated, and its speed in deep sea areas may be unable to be detected.
- When using a GPS, COG accuracy is less than $\pm 3^\circ$ at speed: from 1kn to 17kn, and is less than $\pm 1^\circ$ at speed: more than 17kn.

5.4.14.2 Entering the ship's heading/own ship's speed manually

If any device such as LOG, etc., connected to this equipment malfunctions, it is possible to manually enter own ship's heading/speed by the method described below to use the target tracking (TT) and true motion display functions.

- 1 Select [Menu] from the corresponding combo box.



The [Sensor Selection/Status] dialog box is displayed.

- 2 When inputting a ship's heading manually, select [MAN] from the [Heading] combo box. To input an own ship speed manually, select [MAN] from the [STW] combo box.
- 3 Click on the input box.

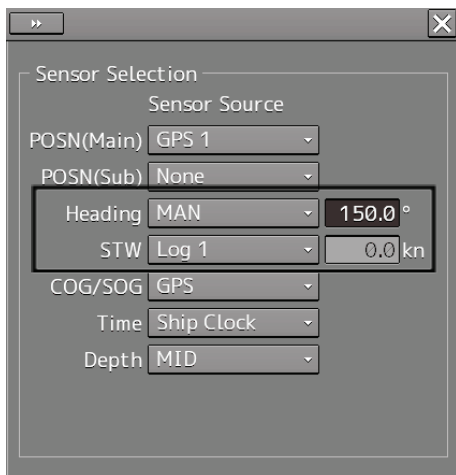

- 4 Enter a numeric value by using the software keyboard.

Section 6 Target Tracking and AIS

This section explains Target Tracking (hereinafter, referred to as target tracking or TT) and Automatic Identification System (hereinafter referred to as AIS).

CAUTION



Use the target tracking function as your navigation aid. Final decision on the ship operation must be made by the ship operator himself.

If you depend entirely on the information of the target tracking function for the final decision on ship operation, an accident may occur.

An error may be contained in the vector, target value data and alarm indicated by the target tracking function. Further, the target not detected by radar cannot be captured or tracked.

If you depend entirely on the information of the radar for the final decision on ship operation, such an accident as collision or stranding may result.



Simulation is a function for determining if the target tracking function is working correctly or not. Accordingly, this function should be used only to check for the target tracking function operation.

In particular, if this mode is used during navigation, a pseudo target will appear on the radar screen and cannot be easily identified from the real target. This may cause such an accident as collision. Do not use this mode during the navigation.

Target Tracking

This function calculates the course and speed of a target by automatically tracking the target's move.

This function enables the automatic acquisition of targets by using the automatic acquisition zone function.

This function also enables the simulation of the ship maneuvering method to avoid collisions by using the trial maneuver function.

Memo

If the mode is ground stabilization, SOG/COG used for own ship's information. If the mode is sea stabilization, STW (speed through the water)/HDG (heading) is used for own ship's information.

Target tracking range is 32 NM. (Available all range scale)

For the details, refer to "6.5 Setting and Operating Target Tracking".

AIS

This function shows the target's information on the radar display, using other ship's information sent out from the AIS unit.

For the details, refer to "6.6 Setting and Operating AIS".

6.1 Restrictions

The acquisition and Target Tracking functions have the following restrictions.

Depending on distance and echo size, resolution between adjacent targets during automatic target tracking usually ranges somewhere between 0.03 to 0.05 NM. If multiple targets approach each other, there is a possibility of swapping them or losing one of them. Such swapping or loss of targets may also occur if the target being tracked is affected by rain/snow clutter or sea clutter or moves very close to land.

The intensity of echoes and the Target Tracking function have a relationship, and thus the target will be lost if no echoes are detected during six scans in succession.

If such a lost target exists, therefore, radar gain must be increased to support detection of the target. If, however, radar gain is increased too significantly, sea clutter or other noise may be erroneously detected and tracked as a target, and resultingly, a false alarm may be issued.

To execute accurate tracking, it becomes necessary first to appropriately adjust the gain, sea clutter suppression, rain/snow clutter suppression and tune of the radar so that the target to be acquired and tracked is clearly displayed on the radar display.

Inappropriate settings of these adjustments reduce the reliability/accuracy of automatic target tracking.

6.2 Collision Avoidance Issue (Explanation)

6.2.1 Collision Avoidance in Navigation

Marine collision avoidance in navigation is one of the problems that have been recognized from of old. This section contains a brief statement about the position of collision avoidance in navigation.

The navigation pattern of all mobile craft constitutes a system with some closed loops regardless of the media through which the mobile craft travels, whether air, water, the boundary between air and water, or space. This pattern consists of two closed loops in principle, one of which is a collision avoidance with another mobile craft and the other is a loop of finding a right and safe way to reach a predeterminate destination.

The following figure shows the conceptual diagram of navigation pattern by Mr. E.W. Anderson. The closed loop of collision avoidance is shown on the left side and the closed loop of finding a safe route on the right side.

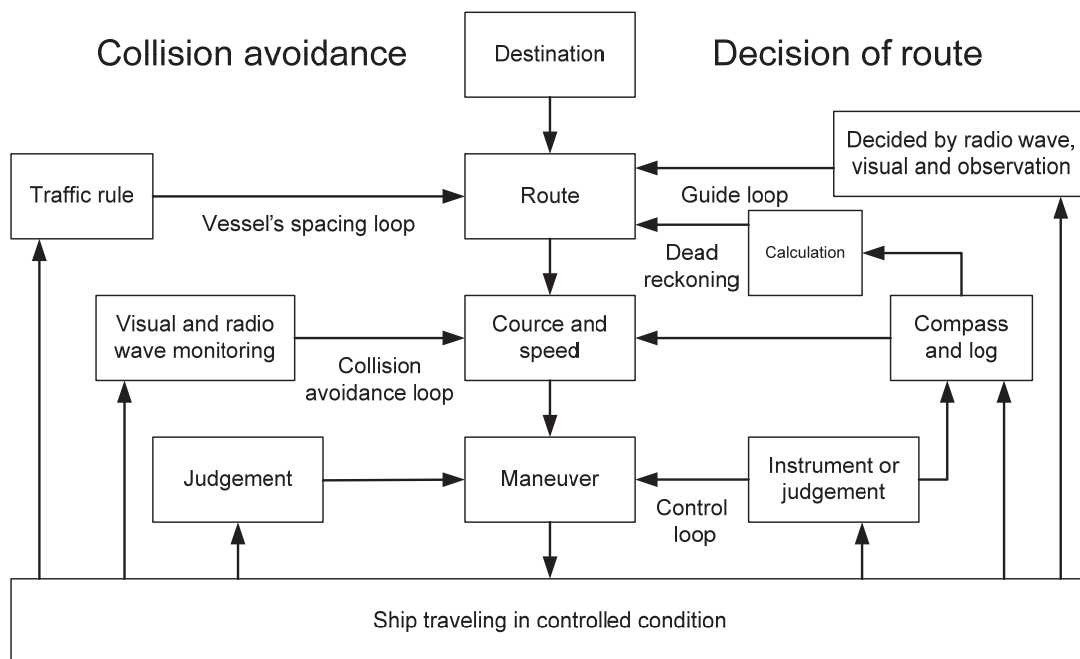

Navigation Pattern

6.2.2 Marine Accidents and Collisions

Among marine accidents, collision accidents have been highlighted as the tonnages and speeds of ships become higher along with the increase in traffic at sea.

If a tanker carrying dangerous articles such as crude oil collides with any other vessel, then not only the vessels involved with the accident but other vessels in the vicinity, port facilities and inhabitants in the coastal area as well as marine resources may also suffer immeasurable influence.

Collision accidents have a high percentage of the marine accidents that have occurred in recent years. To cope with these problems, any effective measures are needed and some equipment to achieve collision avoidance requirements has been developed at rapid strides.

6.2.3 Basic Concept of Collision Avoidance

There are two aspects in collision avoidance: collision prediction and avoidance. Putting it in extreme terms, collision prediction is to predict that two or more vessels will happen to occupy the same point at the same time, while collision avoidance is to maneuver vessels not to occupy the same point at the same time.

In practical operation of vessels, a spot of collision has to be deemed to be a single point but a closed zone. This closed zone is conceptually defined as a CPA (Closest Point of Approach). Further, the time taken to arrive at CPA is required for collision prediction, and the danger of collision is judged considering the TCPA (Time to CPA). The following figure illustrates a diagram caked "Collision Triangle".

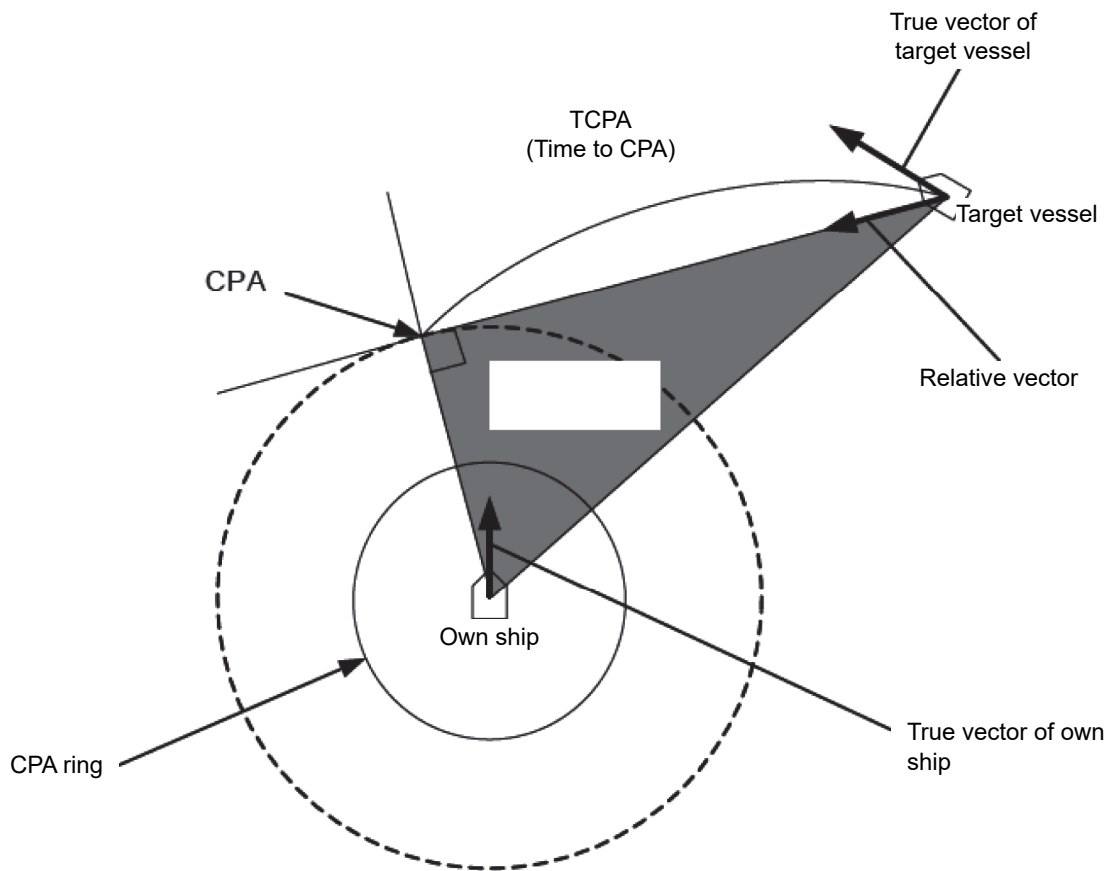

6.2.4 Relative Vector and True Vector

From two points of view, collision prediction and avoidance, it is necessary to obtain the relative vector of other ship for prediction and the true vector of other ship for collision avoidance in order to realize other ship's aspect.

The relationship between the relative vector and true vector is shown in the following figure.

Furthermore, the meanings of both vectors are explained.

Both rough CPA and TCPA can be obtained easily from the relative speed vector of other ship. This method has an advantage that the risks of collision with all other ships within the radar range can be seen at a glance. On the other hand, the course and speed of other ship can easily be obtained from its true speed vector, enabling other ship's aspect to be seen at a glance. Thus, the aspects of other ships (transverse, outsail, parallel run, reverse run, etc.) as described in the act of prevention of collision at sea can be readily understood. If there is a risk of collision with other ship, the operator can determine which rule to be applied and how to operate own ship.

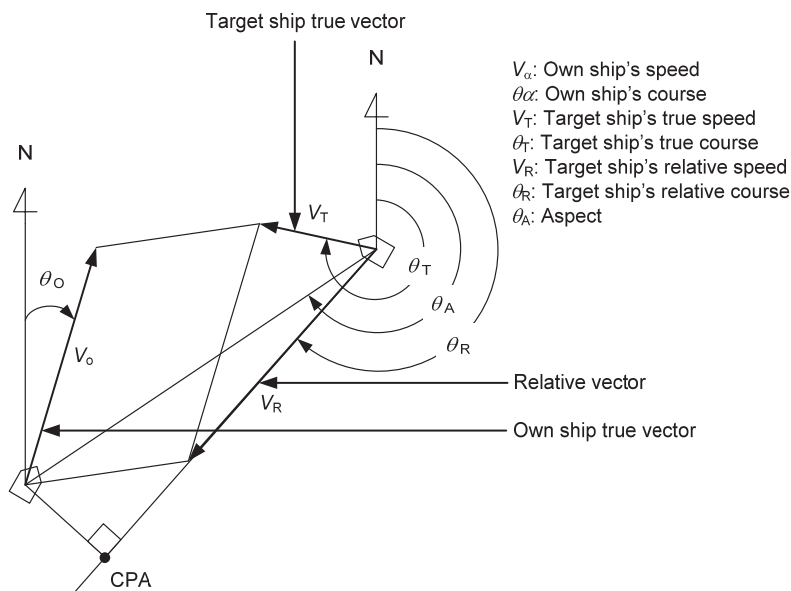

6.2.5 Radar and Collision Avoidance

Radar is still playing an important role for collision prevention and positioning.

A plotter is used to further enhance the radar functionality. The plotter is capable of plotting other positions of other ships in 3 to 6 minute intervals to monitor their movement. The plots of other ships represent their tracks relative to own ship, and it is shown whether there is a risk of collision, namely CPA and TCPA can be obtained. This method using a plotter is fairly effective, but the number of target ship, which is manually plotted, is limited and it takes several minutes to measure those.

6.3 Displaying Symbols







This section describes the symbols that are used for target tracking and AIS.

6.3.1 Displaying/hiding target tracking symbols/AIS target symbols

In the display setting at the time of shipment from the factory, the display of target tracking symbols and of the AIS target symbols is enabled. However, choosing [Options] – [Target] from the View menu can switch between display and hide.

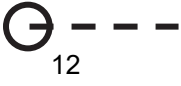
For the details, refer to "16.2.9 Setting up the display of TT/AIS target".

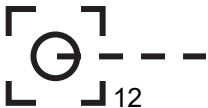
6.3.2 Types and Definitions of Target Tracking Symbols

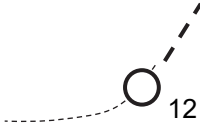
Symbol	Definition	Remarks
	Initial acquisition target	This symbol is displayed until the vector is displayed after target acquisition.
	Target acquired in automatic acquisition zone	The alarm sounds. The alarm message (New Target) turns orange and blinks. The symbol turns red and blinks.
	Tracked target	This means a tracked target.
	Dangerous target	The alarm sounds. The alarm message (CPA/TCPA) turns red and blinks. The symbol is enlarged and displayed in red.
	Numeric displayed target	When the numeric data is displayed, the target symbol is enclosed in a square.
	Lost target	The alarm sounds. The alarm message (Lost) turns orange and blinks. The symbol turns red.
	Past position	The past positions of an AIS target are displayed as well as the target tracking symbol.
	Target track	The track of another ship as an AIS target is displayed as well as the target tracking symbol.









Memo









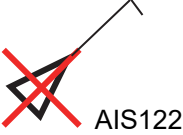

When a target acquired from RADAR is displayed on the ECDIS screen, the ID is prefixed by "T1-" or "T2-" (such as "T1-12" and "T2-12"). On the RADAR screen, only the ID is displayed, not the symbol.



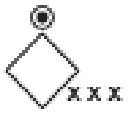



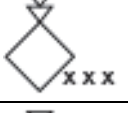
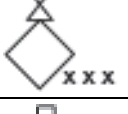
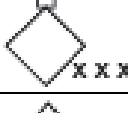
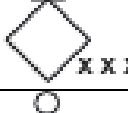

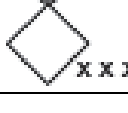

Memo



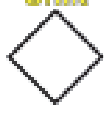





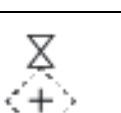



The initial acquisition target is displayed only when TTM sentence is received from RADAR.









6.3.3 Types and Definitions of AIS Target Symbols

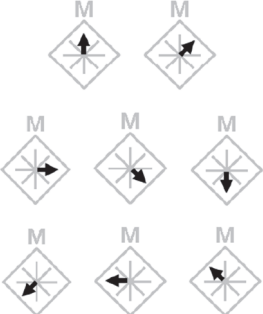



Symbol	Definition	Remarks
	Sleeping target	This symbol is displayed when received data is valid. The direction of the triangle's vertex indicates the target's heading or course.
	Target in pause state	When CTW/STW of the target cannot be received, the symbol is displayed in a broken line.
 AIS12	Activated target	The heading direction is displayed with a solid line, and the course vector is displayed with a dotted line. The line perpendicular to the heading direction indicates the direction to which the course is to be changed. This line may not be displayed.
 AIS12	Activated target	When CTW/STW of the target cannot be received, the symbol is displayed in a broken line.
 AIS12	Outline display	The outlines of ships are displayed scaled down.
 AIS12	Numeric displayed target	When the numeric data is displayed, the target symbol is enclosed in a square.
 AIS12	Dangerous target	The alarm sounds. The alarm message (CPA/TCPA) turns red and blinks. The symbol is enlarged and displayed in red.
 AIS12	Danger target	When CTW/STW of the target cannot be received, the symbol is displayed in a broken line.
 AIS122	Lost target	The alarm sounds. The alarm message (Lost) turns orange and blinks. The symbol is displayed by overlaying red x marks.

Symbol	Definition	Remarks
	Sleeping AIS-SART target	Displayed by the same color as AIS symbol.
	Activated AIS-SART target	Displayed target No. nearby the symbol.
	Numerical display AIS-SART target	When the numeric data is displayed, the target symbol is enclosed in a square.
	Lost AIS-SART target	Displayed if AIS-SART data is not received for 6 minutes.
	Physical AIS AtoN target (Racon)	The target No./AtoN name (xxx) is displayed next to the symbol.
	Physical AIS AtoN target (Emergency wreck mark)	The target No./AtoN name (xxx) is displayed next to the symbol.
	Physical AIS AtoN target (North cardinal mark)	The target No./AtoN name (xxx) is displayed next to the symbol.
	Physical AIS AtoN target (East cardinal mark)	The target No./AtoN name (xxx) is displayed next to the symbol.
	Physical AIS AtoN target (South cardinal mark)	The target No./AtoN name (xxx) is displayed next to the symbol.
	Physical AIS AtoN target (West cardinal mark)	The target No./AtoN name (xxx) is displayed next to the symbol.
	Physical AIS AtoN target (Port hand mark)	The target No./AtoN name (xxx) is displayed next to the symbol.
	Physical AIS AtoN target (Starboard hand mark)	The target No./AtoN name (xxx) is displayed next to the symbol.
	Physical AIS AtoN target (Isolated danger)	The target No./AtoN name (xxx) is displayed next to the symbol.
	Physical AIS AtoN target (Safe water)	The target No./AtoN name (xxx) is displayed next to the symbol.

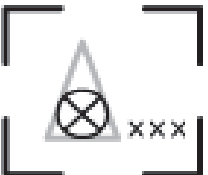
Symbol	Definition	Remarks
	Physical AIS AtoN target (Special mark)	The target No./AtoN name (xxx) is displayed next to the symbol.
	Physical AIS AtoN target (Off position)	The symbol and target No./AtoN name (xxx) nearby the symbol are indicated in yellow.
	Physical AIS AtoN target (On position)	The target No./AtoN name (xxx) is displayed next to the symbol.
	Physical AIS AtoN target (Numerical display)	When the numeric data is displayed, the target symbol is enclosed in a square.
	Physical AIS AtoN target (Lost display)	The alarm sounds. The alarm message (Lost) turns orange and blinks. The symbol is displayed by overlaying red x marks.
	Physical AIS AtoN target (Flood light abnormality)	"Unlit" is displayed in yellow at the top of the symbol. The target No./AtoN name (xxx) is displayed nearby the symbol.
	Physical AIS AtoN target (radar beacon abnormality)	"Racon err" is displayed in yellow at the top of the symbol. The target No./AtoN name (xxx) is displayed nearby the symbol.
	Virtual AIS AtoN target (Emergency wreck mark)	The target No./AtoN name (xxx) is displayed next to the symbol.
	Virtual AIS AtoN target (North cardinal mark)	The target No./AtoN name (xxx) is displayed next to the symbol.
	Virtual AIS AtoN target (East cardinal mark)	The target No./AtoN name (xxx) is displayed next to the symbol.
	Virtual AIS AtoN target (South cardinal mark)	The target No./AtoN name (xxx) is displayed next to the symbol.
	Virtual AIS AtoN target (West cardinal mark)	The target No./AtoN name (xxx) is displayed next to the symbol.

Symbol	Definition	Remarks
	Virtual AIS AtoN target (Port hand mark)	The target No./AtoN name (xxx) is displayed next to the symbol.
	Virtual AIS AtoN target (Starboard hand mark)	The target No./AtoN name (xxx) is displayed next to the symbol.
	Virtual AIS AtoN target (Isolated danger)	The target No./AtoN name (xxx) is displayed next to the symbol.
	Virtual AIS AtoN target (Safe water)	The target No./AtoN name (xxx) is displayed next to the symbol.
	Virtual AIS AtoN target (Special mark)	The target No./AtoN name (xxx) is displayed next to the symbol.
	Virtual AIS AtoN target (Numerical display)	When the numeric data is displayed, the target symbol is enclosed in a square.
	Virtual AIS AtoN target (Lost display)	The alarm sounds. The alarm message (Lost) turns orange and blinks. The symbol is displayed by overlaying red x marks.
	Virtual AIS AtoN target (Intended location of missing AtoN)	"Missing" is displayed in yellow at the top of the symbol. The target No./AtoN name (xxx) is displayed nearby the symbol.
	Physical mobile AIS AtoN target	The target No./AtoN name (xxx) is displayed next to the symbol.
	Virtual mobile AIS AtoN target	The target No./AtoN name (xxx) is displayed next to the symbol.
	Virtual AtoN Error	It is an icon when RACON err/off is combined.
	Mobile AIS AtoN target (AtoNStatus = 0xae)	Self-propelled, but direction not reported or unavailable (AtoN Status bits 1010111x):

Symbol	Definition	Remarks
	<p>Mobile AIS AtoN target (AtoNStatus = 0xaa)</p>	<p>Tethered (AtoN Status bits 1010101x):</p>
	<p>Mobile AIS AtoN target (COG information is provided)</p>	<p>If COG information is provided, it shall be presented with an arrow pointed in coarse direction of COG within $\pm 22,5^\circ$ sectors as defined by AtoN Status bits.</p>
	<p>AIS SAR aircraft</p>	<p>Displayed by the same color as AIS symbol.</p>
	<p>Numerical display AIS SAR aircraft</p>	<p>When the numeric data is displayed, the target symbol is enclosed in a square.</p>
	<p>Lost AIS SAR aircraft</p>	<p>The alarm sounds. The alarm message (Lost) turns orange and blinks. The symbol is displayed by overlaying red x marks.</p>
	<p>AIS SAR aircraft (helicopter)</p>	<p>Displayed by the same color as AIS symbol.</p>
	<p>Numerical display AIS SAR aircraft (helicopter)</p>	<p>When the numeric data is displayed, the target symbol is enclosed in a square.</p>
	<p>Lost AIS SAR aircraft (helicopter)</p>	<p>The alarm sounds. The alarm message (Lost) turns orange and blinks. The symbol is displayed by overlaying red x marks.</p>
	<p>AIS SAR ship</p>	<p>Displayed by the same color as AIS symbol.</p>
	<p>Numerical display AIS SAR ship</p>	<p>When the numeric data is displayed, the target symbol is enclosed in a square.</p>

Symbol	Definition	Remarks
	Lost numerical display AIS SAR ship	The alarm sounds. The alarm message (Lost) turns orange and blinks. The symbol is displayed by overlaying red x marks.
	AIS coastal base station	Displayed by the same color as AIS symbol.
	Numerical display AIS coastal base station	When the numeric data is displayed, the target symbol is enclosed in a square.
	Lost AIS coastal base station	The alarm sounds. The alarm message (Lost) turns orange and blinks. The symbol is displayed by overlaying red x marks.
	Call or unread message symbol (Example: Call or unread message symbol with AIS Target)	Received call or unread message shall be presented by having two increasing centered 1/8 arcs drawn using a thin solid line at upper right-hand side of the AIS target symbol, AIS AtoN physical symbol, Base station symbol etc. Displayed by the same color as AIS symbol.

6.3.4 About AIS AtoN (Aids to Navigation)

AIS AtoN is a system that displaying aid to navigation like a lighthouse, light buoy or unreal aid to navigation on the display unit on ships using AIS receiver.

There are following four kinds of AIS AtoN.

AIS AtoN type	Function	Operation example
Physical AIS AtoN	Installs the AIS on real aid to navigation, and displays its location on the display unit on ships.	In low visibility, receiving the Physical AIS AtoN symbols facilitates identification of the light location and light buoy.
Virtual AIS AtoN	Displays virtual aid to navigation on the display unit on ships according to the signals transmitted from the AIS station on the land.	In the sea area where installation of the light buoy is difficult, the Virtual AIS AtoN symbols are displayed as virtual light buoys that are used as targets for getting to the destination. This system can also be used as the aid substituted for the aid to navigation damaged by natural disasters.
Physical mobile AIS AtoN	Installs the AIS on real aid to navigation, and displays its location on the display unit on ships.	In low visibility, receiving the Physical AIS AtoN symbols facilitates identification of the mark a moving or drifting hazard to navigation.
Virtual mobile AIS AtoN	Displays virtual aid to navigation on the display unit on ships according to the signals transmitted from the AIS station on the land.	In the sea area where installation of the physical mobile AIS AtoN is difficult, the Virtual mobile AIS AtoN symbols are displayed as virtual mark a moving or drifting hazard to navigation that are used as targets for getting to the destination.

6.3.5 About AIS-SART Information

The AIS-SART function enables information about the location of life raft or lifeboat on abandoning ship to be displayed on the screen. The location will show the position of potential survivors.

For the details, refer to "7.6 Display of AIS-SART".

6.3.6 About Display Priority of AIS Targets

Up to 460*1 targets can be displayed in total of activated and sleeping AIS targets. Up to 460 activated AIS targets can be displayed in the total.

When 95% of the maximum display count is exceeded, "AIS 95% Capacity" alert occurs. When the maximum display count is exceeded, "AIS maximum capacity" alert occurs.

When there is an AIS target of 460*1 or more, the display is made according to the following priority order.

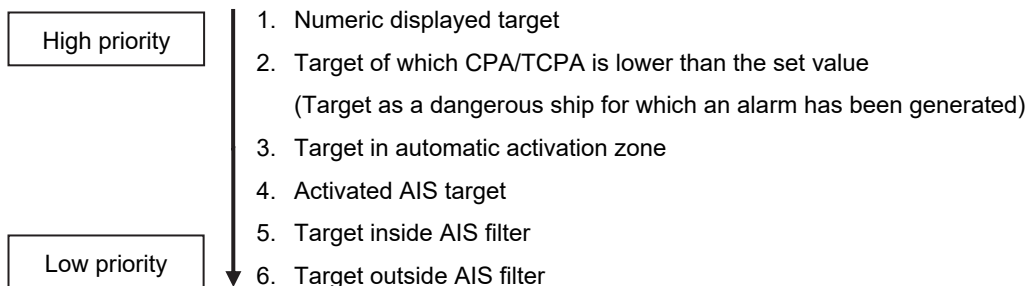

*1: The maximum number of AIS targets displayed can be changed to the option of 960 targets.

If the number of targets at the same priority level exceeds the allowable maximum, they are displayed in the following priority order:

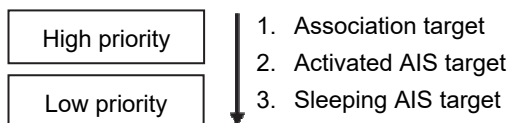

Memo

Maximum display number is sum of Class A AIS and Class B AIS.

Class A: The AIS that must be installed in the large ships specified in the SOLAS Convention.

Class B: The AIS for which medium and small sized vessels and fishing vessels are targeted.

<AIS Capacity>

AIS target= **display:460 or 960, processing = 460 or 960**

95%,Full: Caution (See 5.5.3 for alerts.)

AIS data report= display:20, processing:20

Full: Information (See 5.13.2 for alerts.)

AIS locating device= display:20, processing:20

Full: Information (See 5.14.2 for alerts.)

The AIS target number depends on the MAX AIS Number of installed licenses. Check the installed license in Menu - Maintenance - System information - Functionality.

- AIS target = 460 (MAX AIS Number = 500)

- AIS target = 960 (MAX AIS Number = 1000)

6.3.7 Switching between Ground Vector and Water Vector

The vector of an AIS target is to be displayed with a vector over ground or over water by switching the stabilization mode. The type of the currently displayed vector can be confirmed by viewing the setting of the stable mode.

When [GND] is selected for the stabilization mode: Ground vector

When [Sea] is displayed for the stabilization mode: Water vector

When the vector of an AIS target is displayed with a vector over water, the system has converted the AIS target's vector over ground to the vector over water according to the data received from the AIS and the own ship's information.

6.3.8 Association Target Symbols

Only a few targets transferred from the radar will be designated as associated targets and following radar conventions the symbol for AIS Priority will be the default symbol.

Symbol display for high-priority TT targets



12 ——— Association targets

Symbol display for high-priority AIS targets



AIS12 ——— Association targets

If the operator wished to change to Tracked Target priority symbol follow the these instructions.

- 1 Right-click on the tracked target with association displayed.**

The context menu appears.

- 2 Click on [Property] in the context menu.**

The [TT Target INFO] or [AIS Target INFO] dialog appears.

- 3 Select [AIS] or [TT] from the [Priority] combo box.**

TT Target INFO

Target ID 1

Name ship1

Edit Template

Track No. Off

Reference Target

Priority

AIS Target INFO

Target ID 1

Name SHIP A

Track No. Off

Priority

[AIS]: The AIS target is displayed on a higher priority basis.

[TT]: The TT target is displayed on a higher priority basis.

6.4 Preparation

6.4.1 Setting the Cursor Mode to AUTO Mode

If the cursor mode is set to the AUTO mode, various TT/AIS functions can be executed quickly.

- 1 Click on the [AUTO] (cursor mode selection) button on the left toolbar.



The cursor mode changes to the AUTO mode.

The [AUTO] mode performs operation in accordance with the object at the cursor position when clicked.

For the details, refer to "3.14 Cursor AUTO Mode".

6.4.2 Setting Vector

A vector to represent a target's predicted position can be presented in the True vector or Relative vector mode. In each mode, a Vector Length can be freely changed for a time interval of 1 to 120 minutes.

6.4.2.1 Vector modes

Different vector modes can be used as described below according to the purpose.

To perceive the true state of the target: True Vector

To perceive the closest approach point of the target: Relative Vector

True vector mode

In the true vector mode, the directions of vectors indicate the true courses of targets and the Vector Lengths indicate the values which are proportional to their speeds.

In the true vector mode, the movements of other ships around own ship can be accurately and easily monitored.

Vectors of own ship are displayed as shown below.

Note
In true vector mode, CPA ring cannot be displayed.

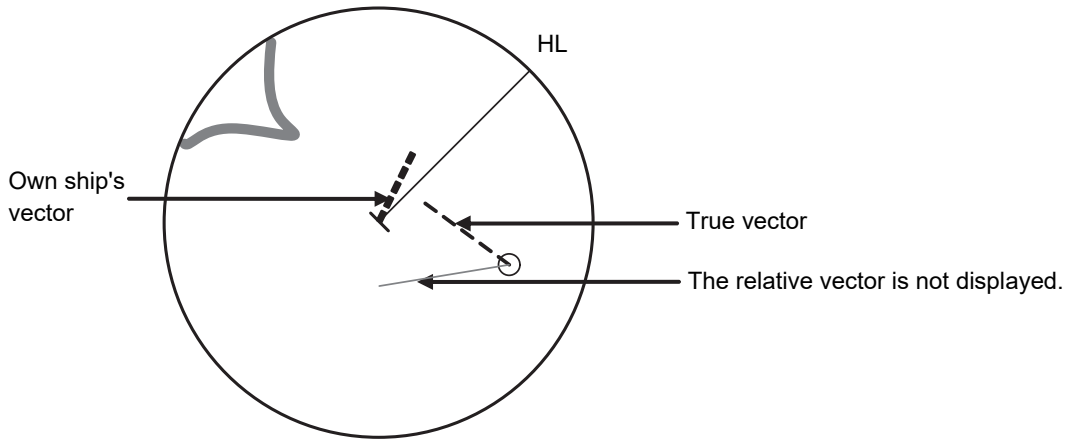

Example of True Vector Mode

Relative Vector Mode

The relative vector does not represent the true motion of the target, but its relative relation with own ship. A target with its relative vector directed to own ship (passing through the CPA limit ring) will be a dangerous target.

In the Relative Vector mode, it can be seen at a glance where the CPA limit of the dangerous target is.

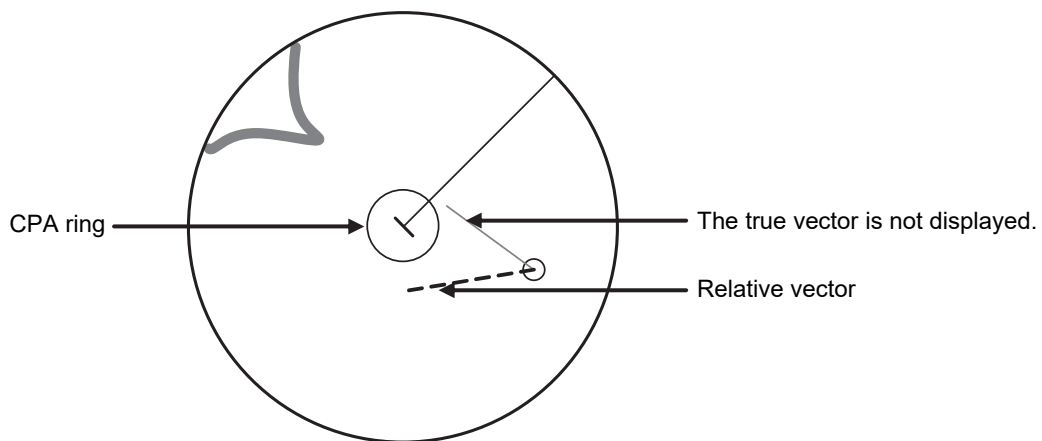

Example of Relative Vector Mode

6.4.2.2 Setting vector mode

- 1 Click on the trail true/relative selector button in the other ship information window.

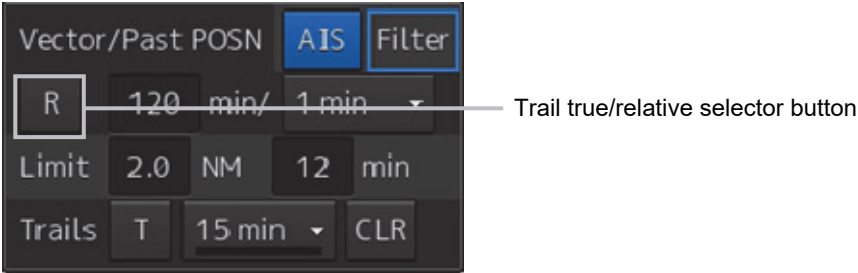

Each click switches track display mode between [T] and [R].

6.4.2.3 Vector Length (Vector Time)

The Vector Length of a target is proportional to its speed, and the vector time can be switched in a range of 1 to 120 minutes.

The following figure shows an example in which the Vector Length is set to 6 min, and the tip of the vector represents the target's position expected to reach 6 minutes later.

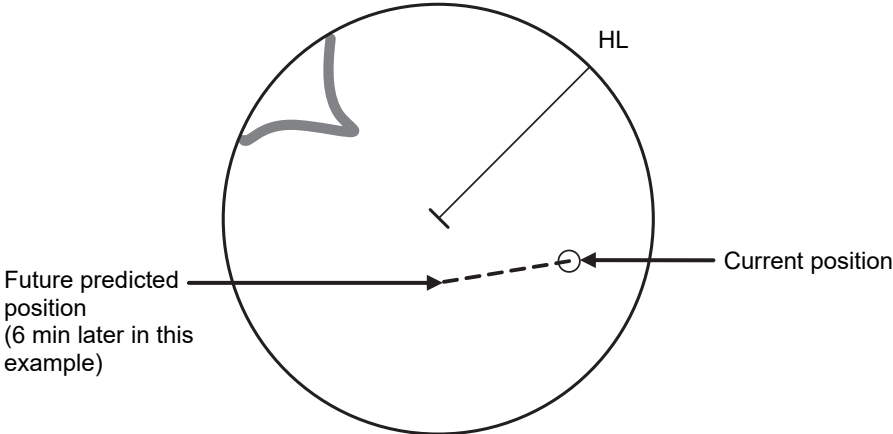

Example of Vector Length

6.4.2.4 Setting the Vector Length

The Vector Length is set in min in the range from 1 min to 120 min.

- 1 Click on the Vector Length input box in the other ship information window.

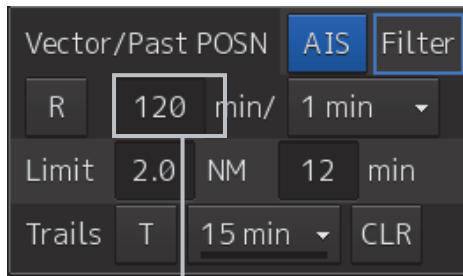

Vector Length input box

- 2 Enter the Vector Length.

6.4.3 Setting collision decision criteria

Collision decision criteria are set based on CPA and TCPA.

For an outline of CPA and TCPA, refer to "6.2.3 Basic Concept of Collision Avoidance."

Note

Set the optimum values of collision decision conditions, with consideration for vessel type, water area, weather and oceanographic conditions.

For the relations between those conditions and alarms, refer to "6.7 Alert Display".

6.4.3.1 Setting CPA limit

- 1 Click on the CPA limit value input box in the other ship information window.

Set the CPA limit in the unit of 0.1 NM within the range from 0.1 NM to 9.9 NM.

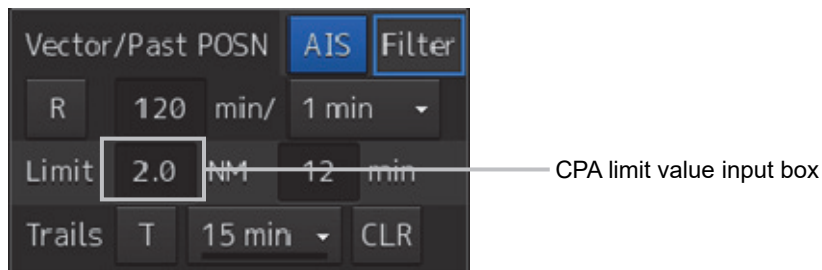

- 2 Enter the CPA limit.

6.4.3.2 Setting TCPA limit

- 1 Click on the TCPA limit value input box in the other ship information window.

Set the TCPA limit in the unit of 1 min within the range from 1 min to 99 min.

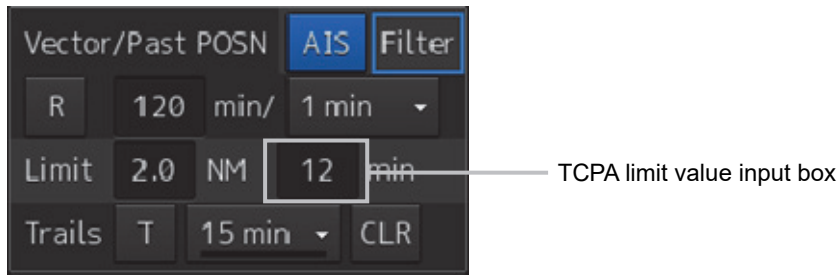

- 2 Enter the TCPA limit.

For the details on how to set up alerts based on the collision determination condition, refer to "17.2 Collision Avoidance Alert Generation Conditions".

6.4.4 Showing the CPA ring (RADAR only)

The CPA ring is rendered as a red circle with the own ship centered and the CPA limit set distance used as the radius.

- 1 Click on the [Menu] button on the left toolbar.

The menu is displayed.

- 2 Click on [View] - [Option] - [Target].

The [Target] dialog is displayed.

- 3 Select [CPA Ring (Only Relative mode)].

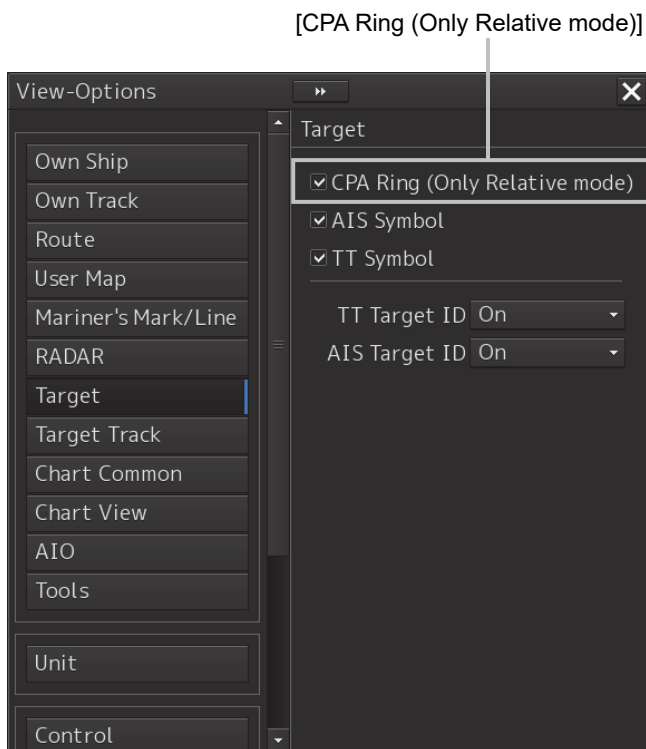

The CPA ring is shown.

Note:

When True is specified for the vector mode, [CPA Ring (Only Relative mode)] cannot be selected.

6.5 Setting and Operating Target Tracking

The Target Tracking function automatically tracks the acquired targets and records and displays the course and speed of the targets as vector. Alerts can also be output based on the set collision decision criteria (CPA and TCPA).

Note

At power off and during preparation for transmission, tracking data records are deleted.

6.5.1 Acquiring target

The methods for acquiring targets include Auto Acquisition (automatic acquisition) mode and ACQ MANUAL (manual acquisition) mode.

Both modes can also be used concurrently.

6.5.1.1 Automatic acquisition (automatic acquisition) mode

By setting up and enabling the automatic acquisition/activation zone (AZ), targets intruding into the AZ can automatically be acquired/tracked and also issue a new target warning.

Note

If manual acquisition is made in a state in which the number of targets being tracked has reached the maximum number of targets, the target with the lowest danger level among the targets that have been captured thus far automatically is erased successively.

When all the targets that are tracked are for manual acquisition and the number has reached the maximum number of targets, no further acquisition is allowed.

Take the following steps to enable automatic acquisition/activation zone (AZ).

1 Click on the [Menu] button on the left toolbar.

The menu is displayed.

2 Click [Alert] - [New Target Alarm] on the menu.

The [New Target Alarm] dialog is displayed.

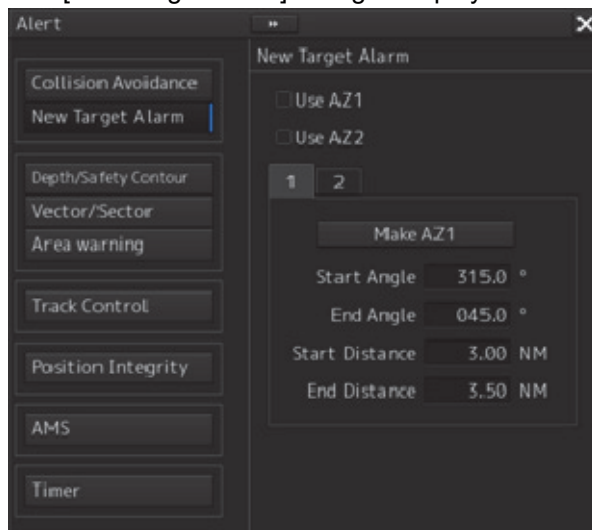

3 Check [Use AZ1] (automatic acquisition zone 1) or [Use AZ2] (automatic acquisition zone 2).

Automatic acquisition/activation zone (AZ) includes AZ1 and AZ2.

To enable AZ1, check [Use AZ1].

To enable AZ2, check [Use AZ2].

Memo

For the details of [New Target Alarm] dialog box, refer to "17.3 New Target Alarm Generation Conditions".

To automatic acquisition/activation zone (AZ):

Clear the check of [Use AZ1] or [Use AZ2].

The AZ can also be enabled/disabled with the [AZ] key on the keyboard operation unit.

For the details of function assignment to the [AZ] key, refer to "18.21 Setting Key Assignment".

6.5.1.2 ACQ MANUAL (manual acquisition) mode

Note

The manual acquisition mode does not function in the following states.

State	Action to Take
The number of tracked targets has reached the maximum count.	Erase unnecessary targets.
The radar antenna is in the standby state.	Wait until the radar antenna becomes ready.
A PROC (Interrupt) warning is being generated.	Clear the warning.
A Gyro (I/F)/Gyro (Data)/Heading (Data) warning is being generated.	
The tracked target is located 32 NM away from own ship.	The manual acquisition mode cannot be used.
The tracked target is located less than 0.1 NM from own ship.	

To acquire the tracked target in the manual acquisition mode

- 1 Set the cursor mode to the AUTO mode.
- 2 Place the cursor on the target to be acquired and then click on.
The target is acquired and the initial acquisition symbol is displayed.
The vector is displayed within 1 minute.

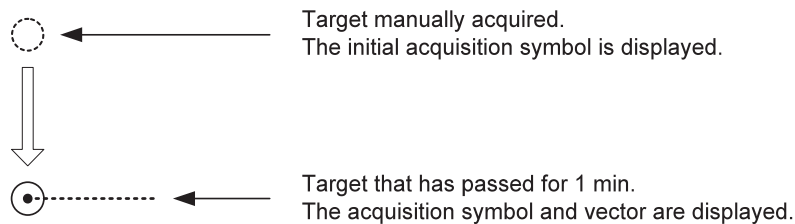

Memo

If only the manual acquisition mode will be used without using auto acquisition/activation together, disable the AZ.

6.5.1.3 Using manual acquisition and auto acquisition together

By using manual acquisition with AZ enabled, auto acquisition and manual acquisition can be used together. They may be used if a target to which particular attention should be given is manually acquired and other targets are automatically acquired.

6.5.2 Setting up the automatic acquisition/activation zone (AZ)

Auto acquisition/activation zone has the shape of sector set up according to the angle and distance as shown in the following figure.

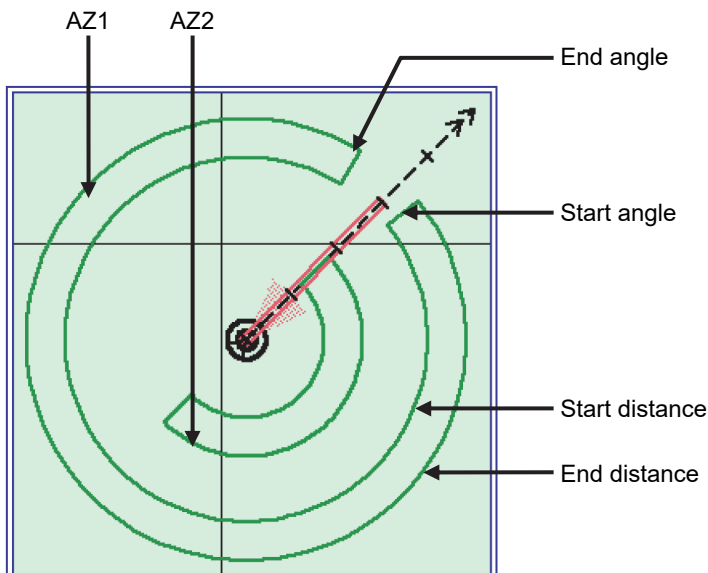

Example of auto acquisition/activation zone (AZ)

Auto acquisition/activation zone (AZ) is set up using the following three methods.

- (1) Use the [New Target Warning] dialog in the [Alert] menu.
- (2) Use the cursor.
- (3) Use the EBL/VRM dial.

Memo

Automatic activation only works for AIS targets inputted from AIS receiver.

6.5.2.1 Using [New Target Warning] dialog box in the [Alert] menu

- 1 Click on the [Menu] button on the left toolbar.

The menu is displayed.

- 2 Click [Alert] - [New Target Alarm] on the menu.

The [New Target Alarm] dialog is displayed.

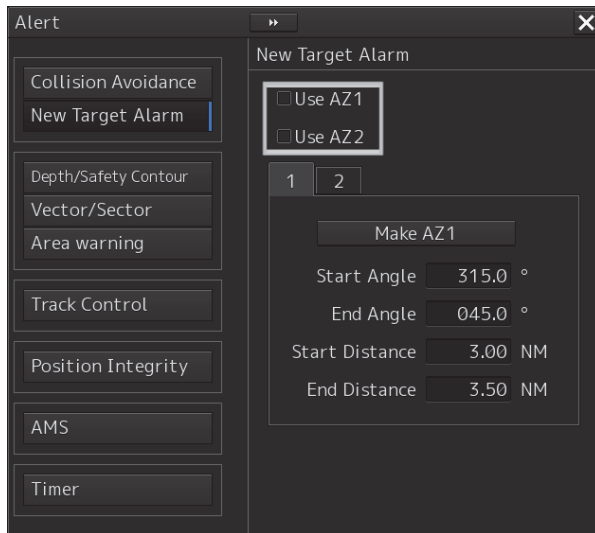

- 3 To set up AZ1, select the [Use AZ1] check box. To set up AZ2, select the [Use AZ2] check box.

- 4 To set up [Use AZ1], click on the [1] tab. To set up [Use AZ2], click on the [2] tab.

Their respective setting items are displayed.

- 5 Enter the start angle, end angle, start distance and end distance of AZ.

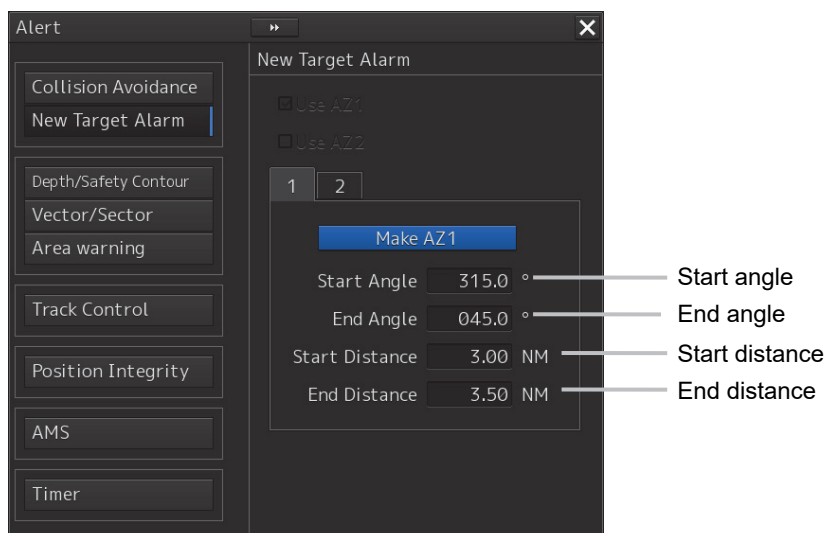

6.5.2.2 Using the cursor

- 1 Click on the [Menu] button on the left toolbar.**
The menu is displayed.
- 2 Click [Alert] - [New Target Alarm] on the menu.**
The [New Target Alarm] dialog is displayed.
- 3 Select AZ ([Use AZ1] or [Use AZ2]) to be set.**

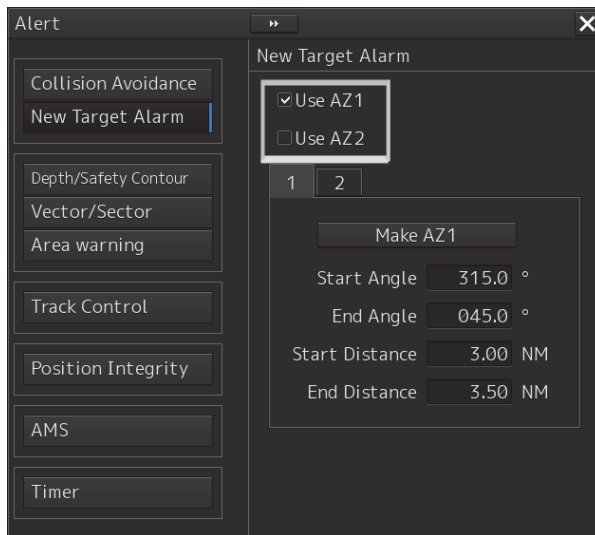

- 4 Click at the start angle position.**
The start angle is set.
- 5 Move the cursor and click at the end angle position.**
The line connecting the start angle and end angle appears.
- 6 Move the cursor and click at the start distance position.**
An arc appears at the start distance position.
- 7 Move the cursor and click at the end distance position.**
Auto acquisition/activation zone (AZ) with the shape of sector enclosed by start angle, end angle, start distance and end distance is created.

6.5.2.3 Using the EBL/VRM dial for the setting

- 1 Click on the [Menu] button on the left toolbar.
The menu is displayed.
- 2 Click [Alert] - [New Target Alarm] on the menu.
The [New Target Alarm] dialog is displayed.
- 3 Select AZ ([Use AZ1] or [Use AZ2]) to be set.

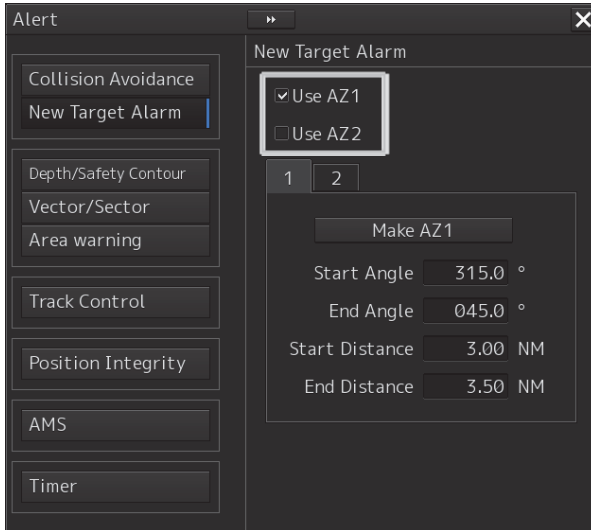

- 4 Click on the [Make AZ1] button or [Make AZ2] button.
The cursor enters the AZ creation mode.

Make AZ1

- 5 Turn the EBL dial to set [Start Angle].
- 6 Turn the VRM dial to set [Start Distance]

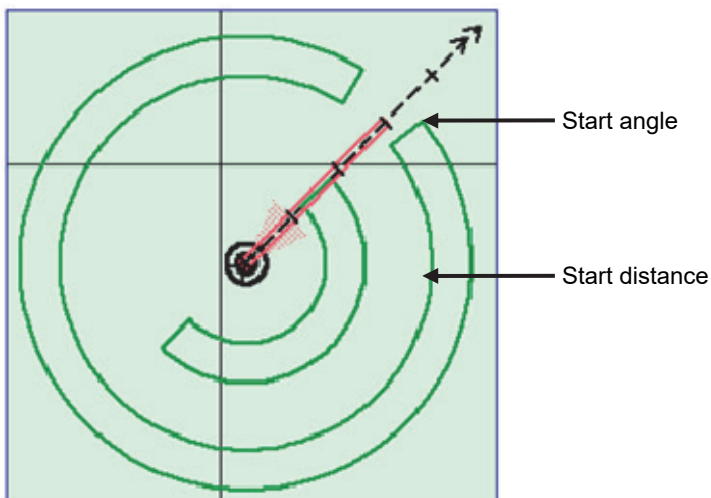

- 7 Press the EBL dial and the VRM dial.
- 8 Turn the EBL dial to set [End Angle].

9 Turn the VRM dial to set [End Distance].

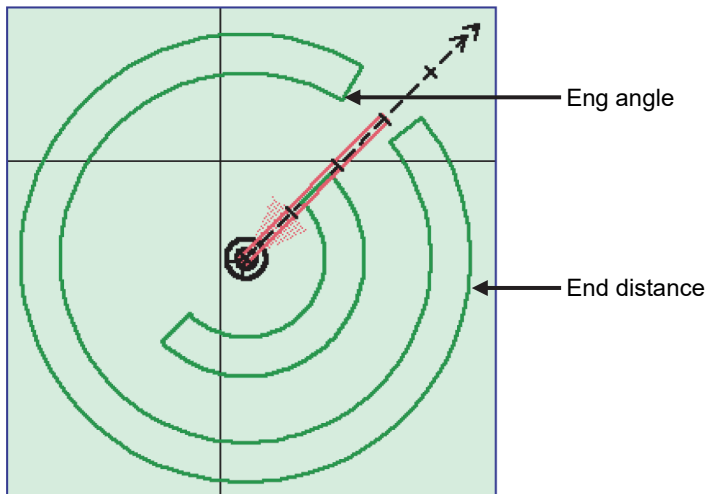

10 Press the EBL dial.

6.5.3 Tracked target information display

Note

When a target or own ship changes its course, or when a new target is acquired, its vector may not reach a given level of accuracy until 3 minutes or more has passed after such course change or target acquisition.

Even if 3 minutes or more has passed, the vector may include an error depending upon the tracking conditions.

1 Set the cursor mode to the AUTO mode.

2 Click on the target of tracking whose numerical value is to be displayed.

Numeric data for the specified target is displayed in the information monitoring window.

TT ID	4	1	
BRG	153.8	041.0	°
Range	8.84	8.48	NM
COG	012.3	028.7	°
SOG	8.7	10.1	kn
CPA	8.10	8.46	NM
TCPA	67.28	-Over	min
BCR		8.70	NM
BCT		+Over	min

The symbol display is changed to "⊙". The target data will remain on the radar display until the target is lost and its vector disappears, or until another target is designated.

If a target with the mark "⊙" is designated, only its true bearing and range appear until its vector appears.

Cancellation of numeric data display

- 1** Set the cursor mode to the AUTO mode.
- 2** Place the cursor on the tracked target to cancel numeric value display and then click on.

The numeric value disappears.

Details on tracked target information

Item	Explanation
TT ID	ID No. of tracked target being displayed
BRG	True bearing
Range	Distance
CTW (Course Through the Water stabilization mode)/ COG (Course Over the Ground stabilization mode)	Course
STW (Speed Through the Water stabilization mode) / SOG (Speed Over the Ground stabilization mode)	Speed
CPA	Closest approach distance
TCPA	Time up to closest approach distance
BCR	Bow crossing distance
BCT	Bow crossing time

6.5.4 Erasing unwanted tracked targets

If the vectors and symbols of the unwanted tracked targets remain displayed, the radar screen may become difficult to view. In such a case, unwanted tracked targets can be erased from the radar screen using the following method.

To erase one target

- 1** Place the cursor on the tracked target to be cancelled and then right-click.
The context menu is displayed.
- 2** Click on the [Cancel TT] on the context menu.
The vector symbol of the tracked target disappears and only the radar image remains.

To erase multiple targets

- 1 Place the cursor on the tracked target to be cancelled and then right-click.**
The context menu is displayed.
- 2 Click on the [Cancel TT mode] on the Context menu.**
The cursor changes to the selection cursor.
- 3 Place the cursor on another target to be cancelled and then click on.**
- 4 Repeat the operation in step 3.**
The vector symbols of the clicked tracked targets disappear and only the radar image remains.

To erase all targets

- 1 Place the cursor on the tracked target to be cancelled and then right-click.**
The context menu is displayed.
- 2 Click on the [Cancel all TT mode] on the Context menu.**
The vector symbols of all the tracked targets disappear and only the radar image remains.

Note

If all targets are cancelled, the tracking of all targets will stop; thus, automatic acquisition or manual acquisition must be performed newly. Unless necessary, do not cancel all targets.

6.5.5 Displaying Target ID No.

A target ID number is a value displayed beside the acquisition symbol when a target is acquired. A target ID number 1 to 100 is automatically assigned to each target in acquisition order. Once a target ID number is assigned, it identifies the target until the target is lost or the target acquisition is canceled.

Memo

The ID number is always displayed for only targets with which numeric data is displayed.

- 1 Click on the [Menu] button on the left toolbar.**
The menu is displayed.
- 2 Click on [View] - [Options] - [Target].**
The [Target] dialog is displayed.

3 Select the method for displaying ID No. from the [TT Target ID] list.

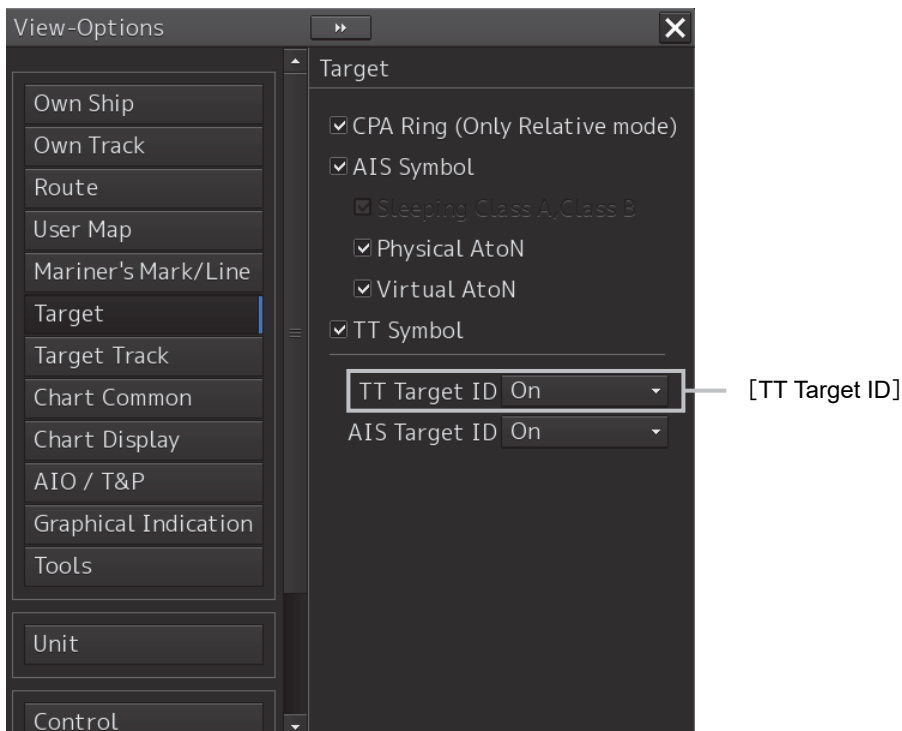

[On]: Displays target ID numbers.

[Off]: Hides target ID numbers.

[TT Track]: Displays ID numbers of only targets set for track of other ships.

[Ship's Name]: When the ship's name has been input in the [TT Target INFO] (property of tracked target) dialog box, that ship name is displayed. If the ship's name has not been input, the identification number is displayed.

Memo

If there are many tracking targets and their symbol display is confusing, set Target Number Display to off to view the radar display easily.

6.5.6 Editing tracked target properties

The tracked target property such as tracked target ID name can be arbitrarily edited for individual tracked targets acquired.

The [TT Target INFO] dialog is used for editing.

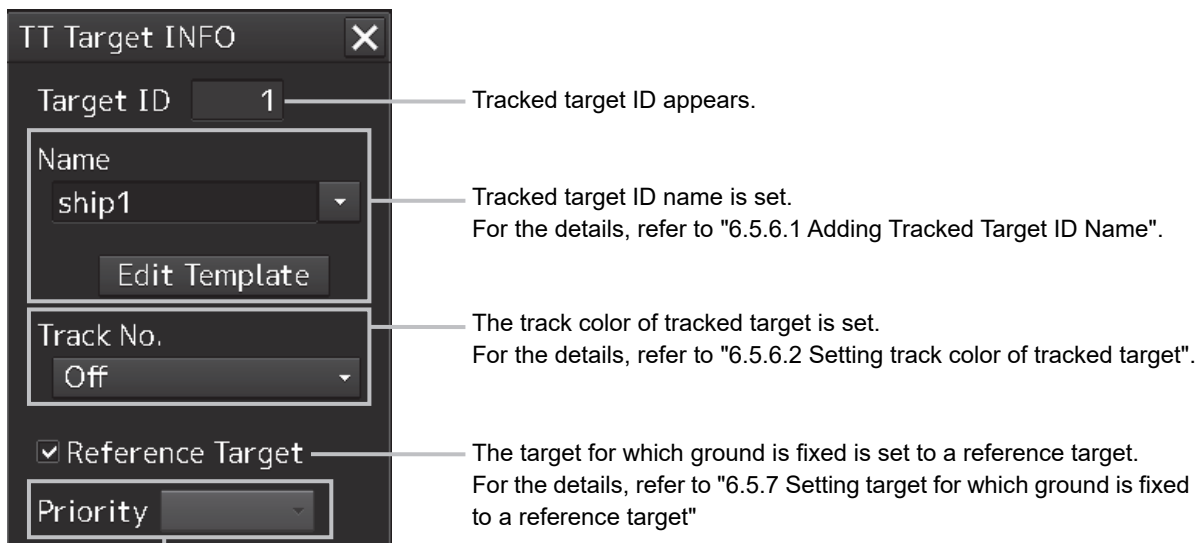

When a TT target and AIS target are determined to be the same targets, the TT target or AIS target to be displayed on a priority basis can be set.

For the details, refer to "6.3.8 Association Target Symbols"

6.5.6.1 Adding Tracked Target ID Name

An ID name can be added to the tracked target acquired.

1 Right-click the cursor on the tracked target.

The context menu is displayed.

2 Click on [Property] on the context menu.

The [TT Target INFO] dialog box appears

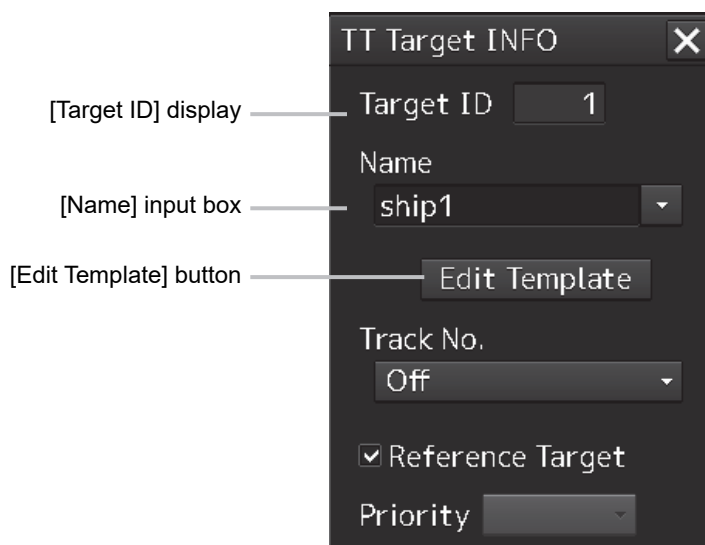

3 Click on the [Name] input box or ▼ .

The input method varies with the selected item.

- | | | |
|-----------|---|---|
| Input box | : | Enter a new name.
When selected, the ship name ([Name]) entry window opens.
Enter a ship name of up to 15 characters. |
| ▼ | : | The names registered as templates are displayed in a list.
Select a name from the list. |

To register ship names as templates

1 Click on the [Edit Template] button in the [TT Target INFO] dialog box.

The [Edit Template] dialog box appears.

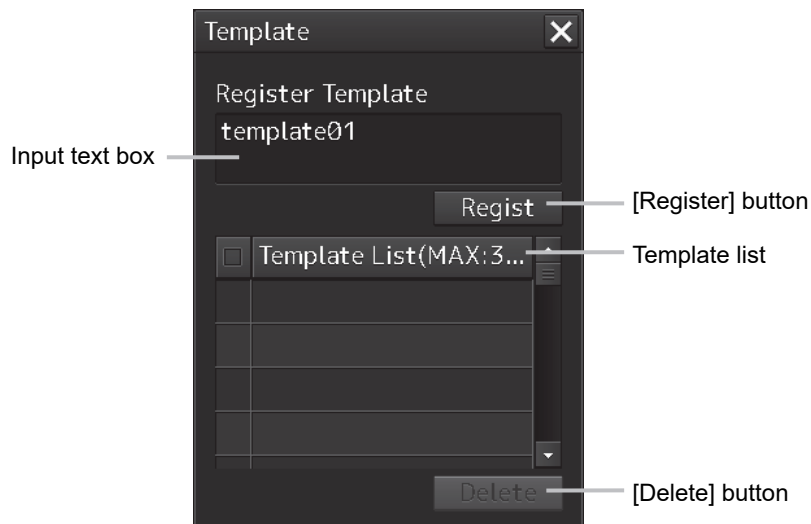

2 Enter the ship name to be registered as a template in the input text box.

3 Click on the [Register] button.

The entered ship name is registered in the template list.

4 Repeat steps 2 and 3, and register necessary ship names.

To cancel unwanted ship name registration

1 On the template list in the [Edit Template] dialog box, check the checkbox of the ship name whose registration to be canceled.

2 Click on the [Delete] button.

The checked ship name is deleted from the template list.

6.5.6.2 Setting track color of tracked target

The track color of tracked target is set.

1 Right-click on the cursor at the tracked target.

2 Click on the [Property] on the context menu.

The [TT Target INFO] dialog box appears.

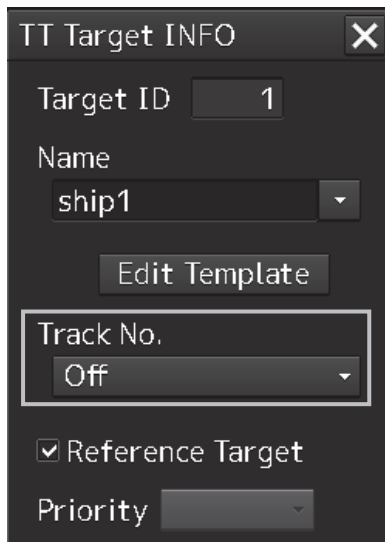

3 Select track color from the [Track Color] list.

The selection items are as follows.

Off, No.1-Color, No.2-Color, No.3-Color, No.4-Color, No.5-Color, No.6-Color, No.7-Color, No.8-Color, No.9-Color, No.10-Color, No.11 to 20-Color

* In "Color," the track color name set by clicking [View] - [Options] - [Target Track] - [Plot] appears. For the details, refer to "16.2.10 Setting up the Display of Other Ship's Track"

6.5.7 Setting target for which ground is fixed to a reference target

By tracking the target for which ground is fixed and setting it to a reference target, the speed of the own ship can be obtained and displayed.

Note

- The reference target function is to be used if the own ship's speed cannot be displayed normally due to trouble such as a speed sensor malfunction. Do not use the reference target function except in emergencies.
- If the speed or course of the own ship is changed or a new reference target is set, the displayed speed may take 3 minutes or more to reach the specified speed after the speed/course change or the setting.
Even after 3 minutes or more has passed, the speed may differ from the specified speed depending on the tracking condition.
- If a large radar echo such as a land target is set as a reference target, the vectors of the speed and other tracking targets will not be displayed correctly and may cause an accident.
- If a sailing ship is set as a reference target, the vectors of the speed and other tracking targets will not be displayed correctly and may cause an accident.
- If the reference target is lost or the Target Tracking function is stopped, the ship speed against the ground will be GPS. (Only if the GPS is equipped.)
- If the reference target is lost or the Target Tracking function is stopped, that will make a major impact on the accuracy of the target tracking and the own ship speed.
- The reference targets are only used for the calculation of true speed.
- Do not use own speed based on reference target tracking for relative speed and CPA/TCPA calculation of AIS targets because the response of own speed is slower than actual own ship's speed change and it may cause a big error on the collision judgement of AIS targets.

1 Acquire the ground-fixed target.

2 Click the right button on the acquired target.

A context menu is displayed.

3 Click on [Property] in the context menu.

The [TT Target INFO] dialog is opened.

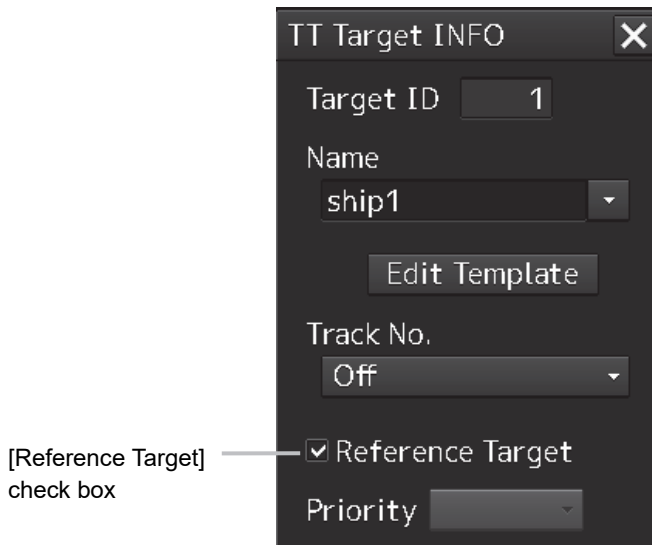

4 To set the target to a reference target, check [Reference Target].

To not set the target to a reference target, uncheck [Reference Target].

5 Select [TGT] from the COG/SOG source combo box in the own ship information at the top right corner of the screen.

The ship speed is automatically calculated from the reference target and is displayed as the COG/SOG speed.

When a reference target is set, the symbol display changes to “ $\text{R}\bigcirc$ ”.

Note

Only one target can be set as a reference target.

When a new reference target is set, the previous reference target is cancelled.

6.5.8 Operation Test for Target Tracking

CAUTION



Simulation is a function for determining if the target tracking function is working correctly or not. Accordingly, this function should be used only to check for the target tracking function operation.

In particular, if this mode is used during navigation, a pseudo target will appear on the radar screen and cannot be easily identified from the real target. This may cause such an accident as collision. Do not use this mode during the navigation.

6

The following operation test and checking are performed to check the operation of target tracking as required. The [TT Test] dialog is used for operation.

1 Click on the [Menu] button on the left toolbar.

The menu is displayed.

2 Click on the [Settings] - [TT Test] on the menu.

The [TT Test] (Test for Target Tracking) dialog is displayed.

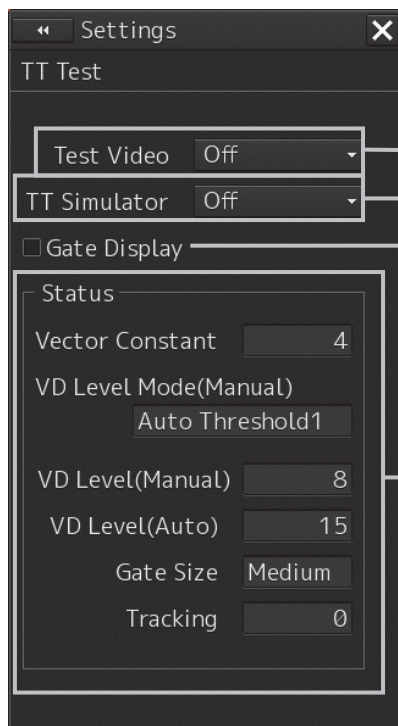

The operation of target detection circuit is checked.
For the details, refer to "6.5.8.1 [Test Video]".

A pseudo-target is generated on the radar screen to check that target tracking operates normally.
For the details, refer to "6.5.8.2 [TT Simulator] (Target tracking simulator)".

The gate size for acquiring and tracking targets are displayed.
For the details, refer to "6.5.8.3 [Gate Display]".

The status of Target Tracking function is displayed.
For the details, refer to "6.5.8.4 [Status] display".

6.5.8.1 [Test Video]

Test Video is used to check whether the video signals under target acquisition and tracking are input to and processed in the target detection circuit normally.

Normally, it is sufficient to just check that the VDIN of the Test Video is displayed.

Note

Test Video may not be displayed for a target which is not yet acquired or tracked. Test Video may not be displayed either if the [GAIN] dial or [SEA] dial is not properly adjusted.

- 1 Click on the [Menu] button on the left toolbar.**
The menu is displayed.
- 2 Click on the [Settings] - [TT Test] on the menu.**
The [TT Test] (Test for Target Tracking) dialog is displayed.
- 3 Select test video to be displayed from the [Test Video] combo box.**

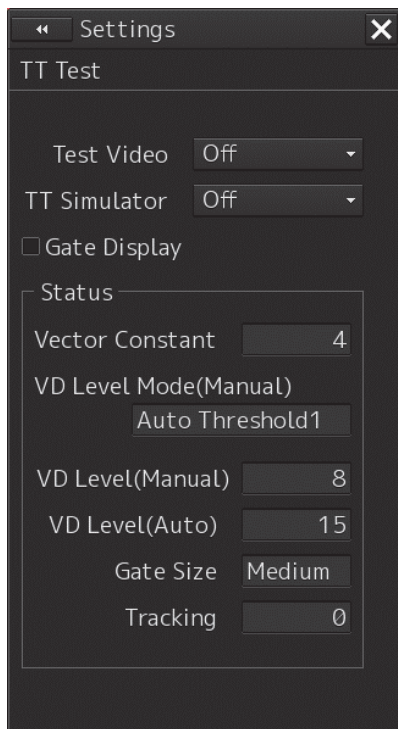

The selected test video is displayed in the rearward of the radar image.

If any target displayed clearly in the normal radar display is not displayed in the Test Video mode, the target detection circuit of the Target Tracking unit may have a trouble.

To cancel test video

- 1 Select [Off] from the [Test Video] combo box.**
Test Video display turns off.

6.5.8.2 [TT Simulator] (Target tracking simulator)

Pseudo-targets are generated in certain known positions to check whether the target tracking units are operating normally. Since the pseudo-targets move depending on known parameters, the values for these pseudo-targets can be compared with the known value if the pseudo-targets are acquired and tracked, and displayed. Thus, it can be checked if the system is operating normally.

- 1 Click on the Standby/Transmit selector button for Radar system information to place the radar in the standby state.**

The button indication changes to [Standby].

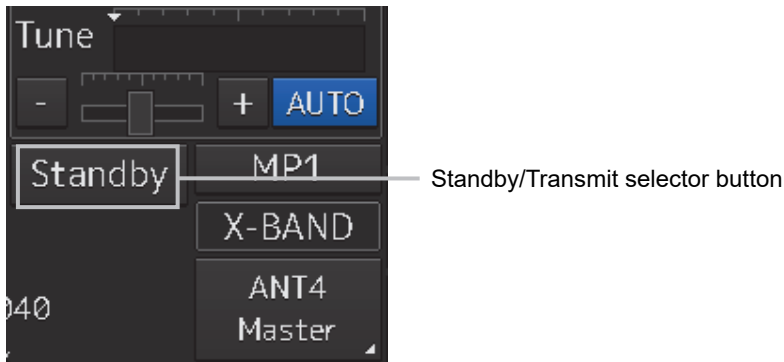

- 2 Click on the [Menu] button on the left toolbar.**

The menu is displayed.

- 3 Click on the [Settings] - [TT Test] on the menu.**

The [TT Test] (Test for Target Tracking) dialog is displayed.

- 4 Select simulator scenario from the [TT Simulator] combo box.**

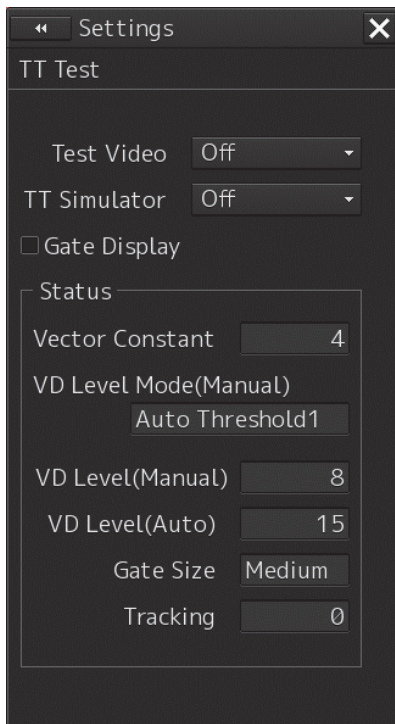

List of target tracking simulator/scenario

Scenario	Target No.	Motion (true motion)	Moving start point		
		Speed [kn]	Course [°]	Range [NM]	Bearing [°]
Scenario1	1	28.3	45	9.5	270
	2	22.4	27	1.12	333
	3	15.3	293	9.25	45
Scenario2	1	30	135	8	23
	2	20	270	5	135
Scenario3	1	45	180	5	23
	2	0	-	3	340
	3	30	0	8	180
Scenario4	1	0	0	2.02	31
	2	70	225	7.01	37
Scenario5	1	20	45	4.47	288
	2	30	45	5.1	304
	3	40	45	6.71	288
	4	0	-	7.07	307
	5	60	200	12	352
	6	20	225	11	315
	7	40	190	14.4	349
	8	-	-	8	318
	9	-	-	9	318
	10	-	-	10	318
Scenario6	1	5	96	5	0
	2	105	225	6	45

Note

- When the simulator is operating, set 0° as the heading bearing

5 Click on the Standby/Transmit selector button to place the radar in the transmission state.

The button indication changes to [Transmit].

The simulator turns on, the pseudo-target is generated, and the letter "X" appears on the lower side of the radar screen and near the pseudo-target to indicate that simulation mode is being executed.

To cancel simulation

1 Click on the Standby/Transmit selector button to place the radar in the standby state.

The button indication changes to [Standby] to enter transmission preparation state.

2 Select [Off] from the [TT Simulator] combo box in the [TT Test] dialog.

TT Simulator display turns off.

6.5.8.3 [Gate Display]

The gate displays an area monitoring a target using the TT function. This equipment allows the gate size to change automatically according to target range and size. The gate size can be checked using the following function.

- 1 Click on the [Menu] button on the left toolbar.**
The menu is displayed.
- 2 Click on the [Settings] - [TT Test] on the menu.**
The [TT Test] (Test for Target Tracking) dialog is displayed.
- 3 Select the [Gate Display] checkbox.**

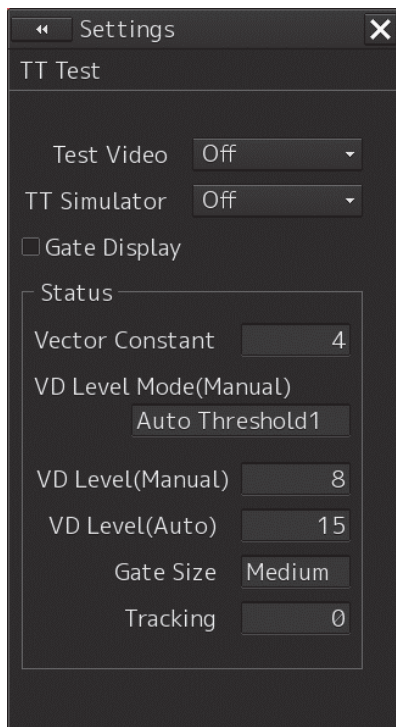

When [Gate Display] is selected, the gate is displayed.

When [Gate Display] is cleared, the gate is not displayed.

- 4 Set the cursor mode to the AUTO mode.**

5 Click on the target of tracking whose numerical value is to be displayed.

Numeric data for the specified target is displayed in the information monitoring window.

TT ID	4	1	
BRG	153.8	041.0	°
Range	8.84	8.48	NM
COG	012.3	028.7	°
SOG	8.7	10.1	kn
CPA	8.10	8.46	NM
TCPA	67.28	-Over	min
BCR		8.70	NM
BCT		+Over	min

The numeric value for the target is displayed, and the gate is displayed in green around the target tracking symbol.

Memo

The Target Tracking can display the gate of two targets simultaneously.

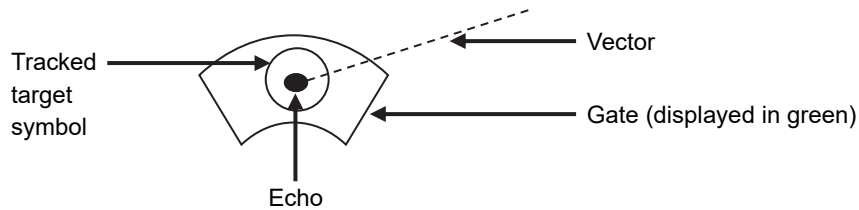

6.5.8.4 [Status] display

The status of the TT function is displayed.

- 1 Click on the [Menu] button on the left toolbar.**
The menu is displayed.
- 2 Click on the [Settings] - [TT/AIS] - [TT Test] on the menu.**
The [TT Test] (Test for Target Tracking) dialog is displayed.
- 3 Check the display of [Status].**

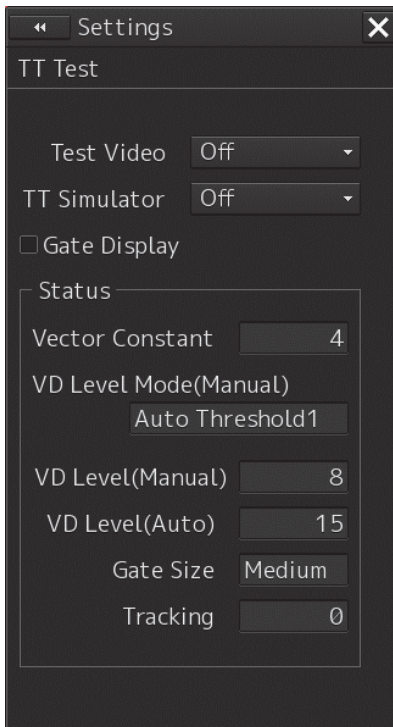

[Vector Constant]	: Vector response
[VD Level Mode (Manual)]	: Using quantization level on manual acquisition
[VD Level (Manual)]	: Quantization level on manual acquisition
[Video Level (Auto)]	: Quantization level on automatic acquisition
[Gate Size]	: Size of gate used for tracking
[Tracking]	: Number of targets currently acquired

6.6 Setting and Operating AIS

6.6.1 Enabling AIS Function

Note

- When the AIS function is set to Off, the AIS display function is turned off and AIS symbols are no longer displayed.
- Once AIS function is set to Off, even if a dangerous target exists, the function is not automatically switched to On.

- 1 Click on the [AIS] button for other ship information on the upper right of PPI.



The button indication becomes ON and the AIS function becomes enabled.

ON indication: 

The received AIS information is displayed on the screen.

6.6.2 Activating AIS targets (Activate AIS)

Activates an AIS target, and displays the target's vector and make a collision decision.

6.6.2.1 Manual activation

Activates an AIS target in manual mode to display the vector and heading line.

- 1 Set the cursor mode to the AUTO mode.
- 2 Place the cursor on the sleeping AIS symbol to be activated and then click on.
The selected AIS target is activated.

6.6.2.2 Automatic activation

Activate an AIS target in automatic mode to display the vector and heading line.

When the automatic activation function is used, AIS targets are automatically activated when they go into the automatic activation zone. The automatic activation zone is identical to the automatic acquisition zone (AZ) used for target tracking. For the zone setting, refer to "6.5.1.1 Automatic acquisition".

Note

When the AIS target's symbol is activated but the vector is not displayed, the following are probable causes of the trouble:

- COG/SOG is not input yet from the GPS.
- The selected speed sensor is malfunctioning.

Memo

The bearing or range in the acquisition/activation zone shall be based on the position of the radar antenna.

If there are more AIS targets than the allowable maximum, they are deactivated from the low-priority (Refer to "6.3 Displaying Symbols").

6.6.3 Deactivating AIS targets

Deactivates an AIS target and clear the display of the vector and heading line.

[Deactivating one AIS target]

- 1 Right-click on the AIS target to be deactivated.**
The setting items for cursor modes are displayed.
- 2 Click on the [Deactivate] on the Context menu.**
The selected AIS target is deactivated.

[Deactivating multiple AIS targets]

- 1 Right-click on the AIS target.**
The setting items for cursor modes are displayed.
- 2 Click on the [Deactivate mode] on the Context menu.**
The cursor changes to the selection cursor.
- 3 Click on the AIS target to be deactivated.**
The selected AIS target is deactivated.

Note

This operation is available only for an activated AIS target.

6.6.4 Displaying AIS information

- 1 Set the cursor mode to the AUTO mode.
- 2 Place the cursor on the AIS target to display the activated AIS target information and then click on.

The information of the selected AIS target is displayed.

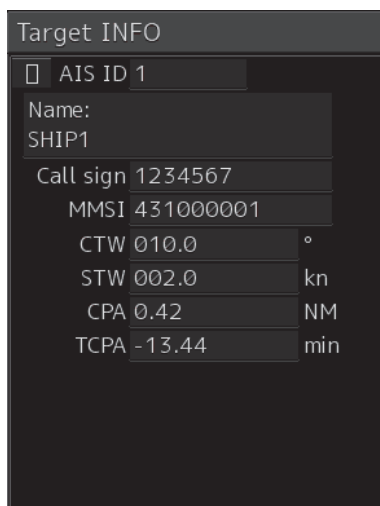

Note

When the numeric data of a target is displayed but the mark " [] " is not on the radar display, the target is outside the display.

Canceling AIS target information display

- 1 Set the cursor mode to the **AUTO** mode.
- 2 Move the cursor to and click on the activated AIS target whose AIS target information is to be cancelled.

The information display of the selected AIS target is canceled.

Details on AIS target information

Two AIS target information display modes are available, a standard mode, and an extended mode, and the items that are displayed vary depending on the mode.

Use the AIS Standard/Extended selector button for switching between the standard mode and the extended mode.

For verifying more detailed information of the AIS target, refer to "2.3.1.4 AID Detail INFO".

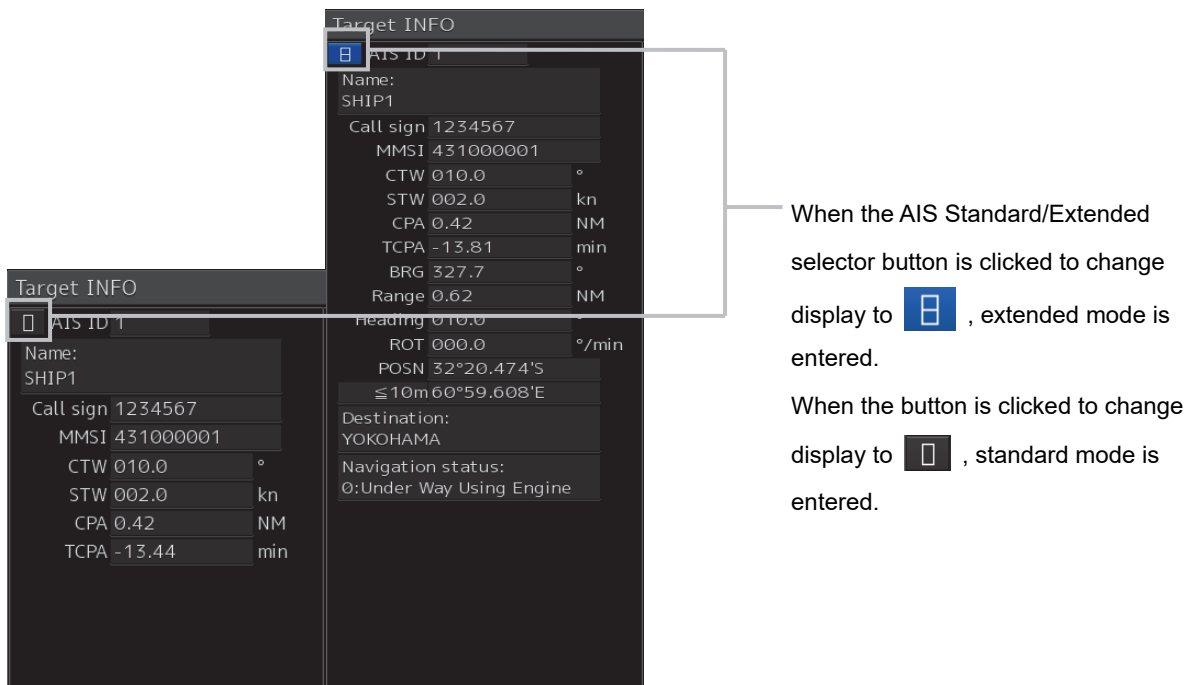

The display contents vary depending on the types of AIS targets.

[Normal AIS target]

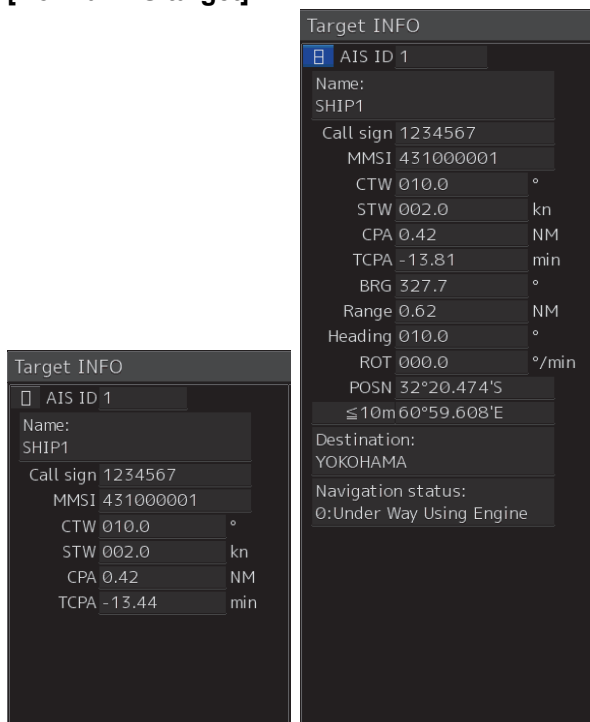

Item	Explanation
AIS ID	ID No. of AIS target
Name	Ship name of AIS target
Call Sign	Call sign of AIS target
MMSI	Maritime Mobile Service Identity
COG or CTW	COG: Course Over the Ground CTW: Course Through Water * In ground mode, COG is displayed. In water mode, CTW is displayed. * Operates in fixed ground mode on the ECDIS screen.
SOG or STW	SOG: Speed Over the Ground STW: Speed Through Water *If the SOG or STW column is Over, the speed of other system is 102.2 kn or more. * In extended mode, the display area for two simple modes is used. * Operates in fixed ground mode on the ECDIS screen.
CPA	Closest approach distance
TCPA	Time up to closest approach distance
BRG	True direction * In standard mode, this item is not displayed.
Range	Distance * In standard mode, this item is not displayed.
Heading	Heading * In standard mode, this item is not displayed.

Item	Explanation
ROT	<p>Rate of turn</p> <p>* In standard mode, this item is not displayed.</p> <p>* The display range of ROT is 0.00°/min to 697.50°/min. In the case of Over, the value will be greater. In the case of $\pm 5/30s$, it indicates that ± 127 is received. At this time, only turning direction indicated on the turn indicator is reliable. The turn indicator is displayed as a straight line normal to the heading direction on the AIS symbol.</p> <p>(Refer to "6.3 Displaying Symbols.")</p>
POSN	<p>Latitude/longitude</p> <p>* In standard mode, this item is not displayed.</p>
>10m or $\leq 10m$	<p>>10m: Low positioning accuracy</p> <p>$\leq 10m$: High positioning accuracy</p> <p>* In standard mode, this item is not displayed.</p>
Destination	<p>Destination</p> <p>* In standard mode, this item is not displayed.</p>
Navigation Status	<p>The status is displayed by number.</p> <p>For the details, refer to "Navigation Status" table.</p> <p>* In standard mode, this item is not displayed.</p>

Memo

In the extended mode, a display area equivalent to two standard mode areas is used.

Navigation Status

Status
0: Under Way Using Engine
1: at Anchor
2: Not Under Command
3: Restricted Maneuverability
4: Constrained by Her Draught
5: Moored
6: Aground
7: Engaged in Fishing
8: Under Way Sailing
9: Reserved for HSC
10: Reserved for WIG
11-14: Reserved
15: Not Defined

[AIS SARTTarget]

Target INFO	
AIS ID 2	
Name:	Missing
MMSI	970000002
CTW	010.0 °
STW	002.0 kn
CPA	0.00 NM
TCPA	0.00 min
BRG	332.3 °
Range	0.36 NM
Heading	°
ROT	°/min
POSN	32°20.685'S
	≤10m 60°59.805'E
Navigation status:	0:Under Way Using Engine

There is neither the Call Sign nor Destination item. The display of some items of Navigation Status is different. Otherwise, the display contents are the same as those of usual AIS target.

Navigation Status

Display
0 ~ 13: Same display as for the usual ship
14: AIS-SART ACTIVE(14)
15: AIS-SART TEST(15)

Memo

Switching between standard and extended modes is not provided.

[AIS AtoN Target]

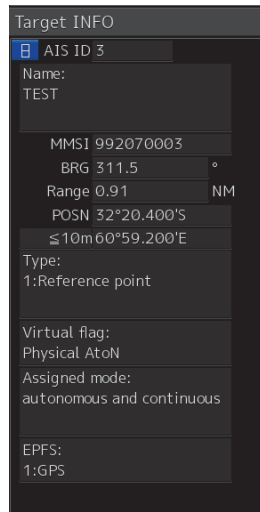
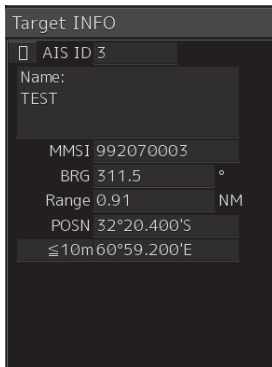

Item	Description
AIS ID	AIS target ID
Name	Ship name of AIS target
MMSI	Maritime Mobile Service Identity code
BRG	True bearing
Range	Range
POSN	Latitude/longitude
>10m or ≤10m	>10m: Position fixing accuracy low ≤10m: Position fixing accuracy high
Type	Displays the AtoN type. For the details, refer to the "Type" table. * Not displayed in standard mode.
Virtual Flag	Real AtoN: Real AtoN Virtual AtoN: Virtual AtoN (does not exist) * Not displayed in standard mode.
Assigned Mode	Autonomous and continuous: Operating in autonomous/continuous mode Assigned: Operating in assignment mode * Not displayed in standard mode.
EPFS	Displays the EPFS type. For the details, refer to the "EPFS" table. * Not displayed in standard mode.

Type

Display
0: Not Available
1: Reference point
2: RACON
3: Fixed structure off shore
4: Spare
5: Light, without sectors
6: Light, with sectors
7: Leading Light Front
8: Leading Light Rear
9: Beacon, Cardinal N
10: Beacon, Cardinal E
11: Beacon, Cardinal S
12: Beacon, Cardinal W
13: Beacon, Port hand
14: Beacon, Starboard hand
15: Beacon, Preferred Channel Port hand
16: Beacon, Preferred Channel Starboard hand
17: Beacon, Isolated danger
18: Beacon, Safe water
19: Beacon, Special mark
20: Cardinal Mark N
21: Cardinal Mark E
22: Cardinal Mark S
23: Cardinal Mark W
24: Port hand Mark
25: Starboard hand Mark
26: Preferred Channel Port hand
27: Preferred Channel Starboard hand
28: Isolated danger
29: Safe Water
30: Special Mark
31: Light Vessel /LANBY/Rigs

EPSF

Display
0: Undefined
1: GPS
2: GLONASS
3: combined GPS/GLONASS
4: LORAN-C
5: Chayka
6: INS
7: surveyed
8: Galileo
15: internal GNSS
9-14: not used

6.6.5 Displaying Target ID No.

When an AIS target is activated, a target ID number is displayed next to the AIS target symbol. A target ID number 1 to 1000 is assigned to each target in the order of receiving targets by MFD. Once a target ID number is assigned, it identifies the AIS target until the AIS target is lost.

- 1 Click on the [Menu] button on the left toolbar.**
The menu is displayed.
- 2 Click on the [View] - [Options] - [Target] on the menu.**
The [Target] dialog is displayed.
- 3 Select the method for displaying ID No. from the [AIS Target ID] combo box.**

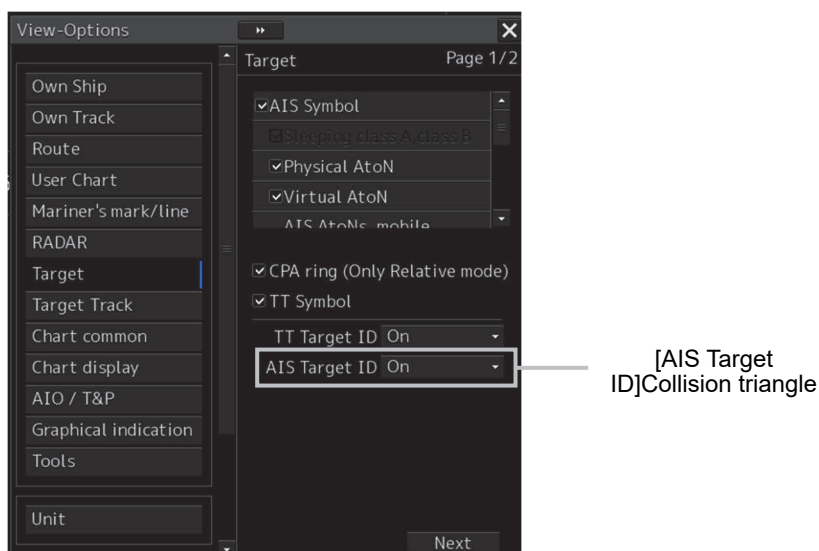

- [On] : Displays target ID numbers.
[Off] : Hides target ID numbers.
[AIS Track] : Displays ID numbers of only targets set for track of other ships.
[Ship's Name] : Displays the ship's name.

Memo

- ID number or ship's name is always displayed for only targets with which numeric value is displayed.
- If there are many AIS targets and their symbol display is confusing, set Target Number Display to off to view the radar display easily.

6.6.6 Checking and setting AIS target property

The AIS target property such as ID name can be checked for individual acquired AIS targets. The track color of AIS target can also be set.

The [AIS Target INFO] dialog is used for editing.

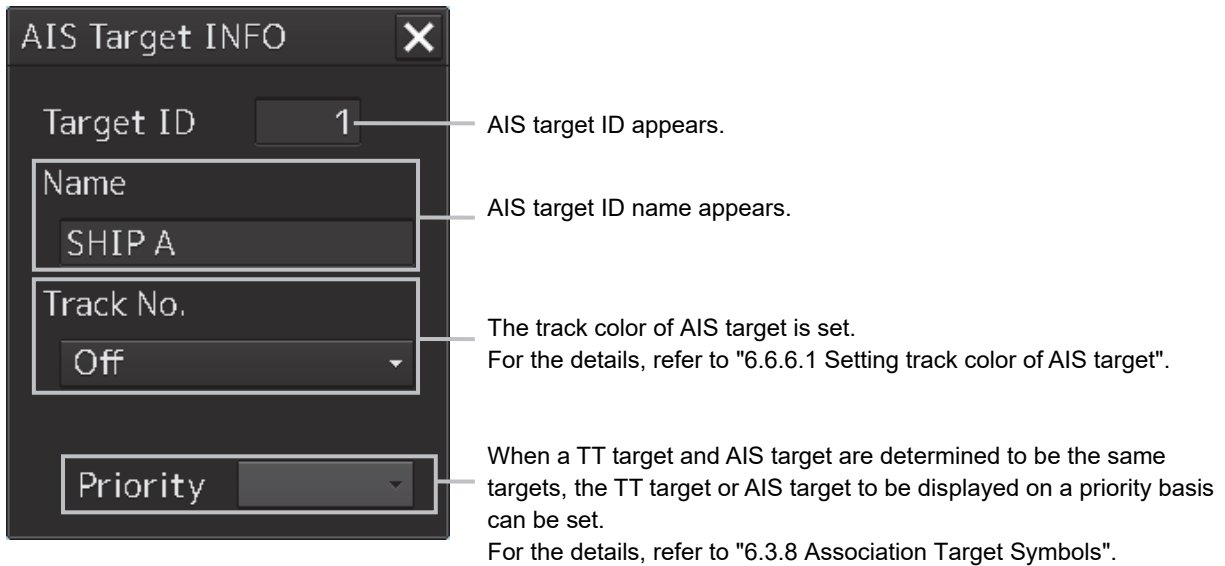

6.6.6.1 Setting track color of AIS target

The track color of AIS target is set.

- 1 Right-click on the AIS target.**
The context menu is displayed.
- 2 Click on [Property] on the context menu.**
The [AIS Target INFO] dialog box appears.

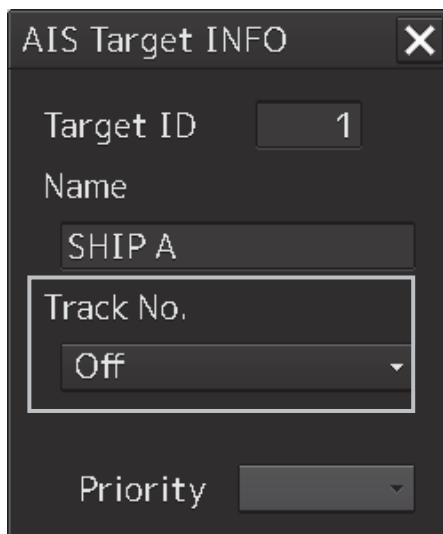

3 Select the track color from the [Track No.] combo box.

The selection items are as follows.

Off, No.1-Color, No.2-Color, No.3-Color, No.4-Color, No.5-Color, No.6-Color, No.7-Color, No.8-Color, No.9-Color, No.10-Color, No.11 to 20-Color

* In "Color," the track color name set by clicking [View] - [Options] - [Target Track] - [Plot] is displayed. For the details, refer to "16.2.8 Setting up the Display of Other Ship's Track".

6.6.7 Conditions for deciding AIS target to be lost

About an AIS target lost

When the data of a target cannot be received for a specified time, the target is decided to be lost and the target data is deleted. As shown in the table below, the time until target data is deleted varies depending on the class of received data and the target status.

Note

- Since the lost time and that of the AIS indicator are different, this equipment may display lost information earlier than the AIS display depending on the target status (speed, navigation status, etc.).
- For lost targets, the target will continue to be displayed until the lost warning is acknowledged. If you leave the approval operation unattended, there is a high possibility that new AIS targets will be difficult to display, so please perform the approval operation as soon as possible.

Conditions for Deciding Target to be Lost 1

Target status	Time until data is lost		
	SOLAS ship (Class A)	Non-SOLAS ship (Class B)	
		CS (Carrier Sense)	SO (Self Organizing)
Vessel below 3 kn (Class A) or 2 kn (Class B) and it is now at anchor or on the berth	18 min	18 min	
Vessel of 3 kn or more and it is now at anchor or on the berth	60 sec	18 min	
Vessel of 0 to 14 kn (Class B: 2 to 14 knots)	60 sec	180 sec	
Vessel of 0 to 14 kn and it is now changing the course	60 sec	180 sec	
Vessel of 14 to 23 knots	36 sec	180 sec	90 sec
Vessel of 14 to 23 kn and it is now changing the course	36 sec	180 sec	90 sec
Vessel of 23 kn or more	30 sec	180 sec	30 sec
Vessel of 23 kn or more and it is now changing the course	30 sec	180 sec	30 sec

Conditions for Deciding Target to be Lost 2

Target status	Time until data is lost
AtoN (Aids to navigation)	18 min
SART	6 min
AIS SAR aircraft (fixed wing, helicopter)	60 sec
AIS coastal base station	60 sec

Note

- When a dangerous ship is lost, a lost warning will be issued and the symbol will change to a lost symbol. It also predicts the current location using the last received data and continues to display the symbol.
- When the [AIS] button in the target ship information window is turned off, the symbol is canceled.

6.7 Alert Display

Target tracking and AIS system have the following alerts.

Message	Description
AIS Active 95% Capacity	The number of activated AIS targets reached 95% of tolerance.
AIS 95% Capacity	The number of AIS targets reached 95% of tolerance.
CPA/TCPA(AIS)	CPA/TCPA warning (AIS)
Lost(AIS)	The AIS target was lost.
AIS maximum capacity	The number of AIS targets reached the maximum number of targets displayed.
New Target(AIS)	The AIS target was acquired and activated.
Not Allowed(TT Out of Range)	Out of TT acquisition range
Trial	Under the trial process. Occurs instead of a danger target alarm when the predicted route of the tracking target intersects with the CPA/TCPA limit range
TT(95% Capacity)	The number of TT targets reached 95% of tolerance.
TT(CPA/TCPA)	CPA/TCPA warning (TT)
TT(Lost)	Acquired TT was lost.
TT(Maximum capacity)	The number of TT targets reached the maximum number of targets.
TT(New Target)	TT was acquired.
TT(Out of Range)	TT went out of 32NM.
TT(Reference Lost)	The TT reference target was lost.

An alert is displayed in the alert notification area (upper right of the screen).

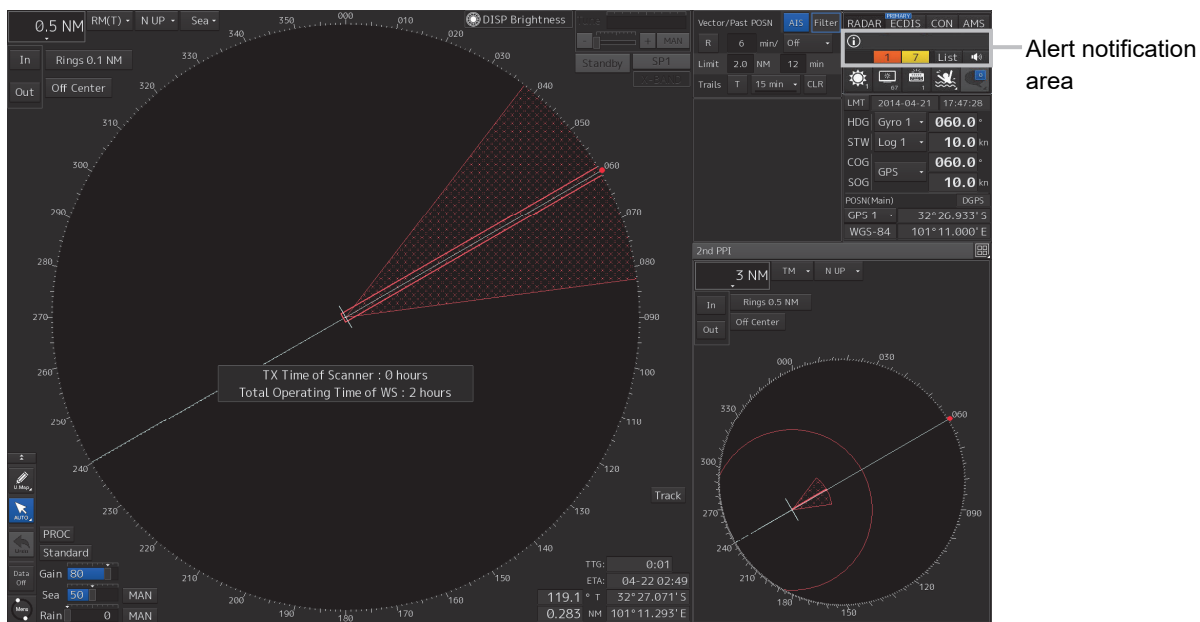

6.7.1 Danger target alarm (CPA/TCPA)

⚠ CAUTION



Since these alarms may include some errors depending on the target tracking conditions, the navigation officer himself should make the final decision for ship operations such as collision avoidance.

Making the final navigation decision based only on the alarm may cause accidents such as collisions.

In this system, targets are categorized into two types: tracked targets and dangerous targets depending on the danger level. The danger level can easily be recognized on the display at a glance. So, it is easily possible for the ship operator to judge which target is to be cautious about.

The danger target symbol of the tracked target will be displayed until either the tracking is stopped or the conditions no longer apply.

The types of target and alarm are shown below.

Dangerous Target Alarm

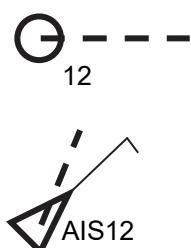
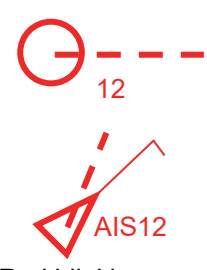
Status	Symbol on display	Alert characters	Alarm sound	Conditions
Tracked target Activated AIS target		(Off)	(Off)	<ul style="list-style-type: none"> • CPA > CPA Limit • 0 > TCPA • TCPA > TCPA Limit <p>The symbol is displayed when one or more of the above conditions are met.</p>
Dangerous target	 Red blinking	CPA/ TCPA	Beep sound (beep-beep-beep) Alarm acknowledgeable	<ul style="list-style-type: none"> • CPA ≤ CPA Limit • 0 ≤ TCPA ≤ TCPA Limit <p>An alarm is issued when all the conditions are met. The sleeping AIS targets will be activated.</p>

CPA Limit and TCPA Limit: Setting Values

6.7.2 Alarm for new target acquired in automatic acquisition guard zone (New target)

 **CAUTION**



In setting an automatic acquisition guard zone, it is necessary to adjust the gain, sea clutter suppression and rain/snow clutter suppression to ensure that target echoes are displayed in the optimum conditions.

No automatic acquisition guard zone alarms will be issued for targets undetected by the radar, and this may cause accidents such as collisions.

The automatic acquisition function sets a zone in a range and issues an alarm when a new target (which is not yet acquired) goes into this zone.

For the setting of an automatic acquisition guard zone, refer to "6.5.1 Acquiring target".

Alarm for New Target Acquired in Automatic Acquisition Guard Zone

Status	Symbol on display	Alert characters	Alarm sound	Conditions
New target in automatic acquisition guard zone	 Red Blinking	New Target	Beep sound (beep-beep) Alarm acknowledgeable	The alarm is issued when a new target is acquired in the automatic acquisition guard zone.

Note

When an already acquired target goes into automatic acquisition guard zone, the alarm for the new target acquired in automatic acquisition guard zone does not sound.

6.7.3 Lost target notification (Lost)

Note

If the gain, sea clutter suppression, rain/snow clutter suppression are not adjusted adequately, the lost target notification may be easily generated. So, such adjustments should be very carefully.

When it is impossible to continue tracking any acquired and tracked target, or the data of AIS target cannot received for a specified time, the [Lost] notification will be issued. The typical causes for alarm are shown below:

- The target echo is very weak.
- The target is hidden by a shore or a large ship and its echo is not received.
- The target echo is blurred by sea clutter or rain/snow clutter.

If a target under tracking goes into a range over 32 NM and can no longer be tracked, it is canceled without a lost target notification being issued.

Lost Target Notification

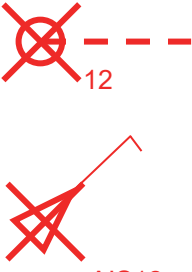
Status	Symbol on display	Alert characters	Alarm sound	Conditions
Lost target	 Red Blinking	Lost	Beep sound (beep-beep) notification acknowledgeable	The notification will sound once when a lost target symbol is displayed.

6.7.4 Target Tracking function alarm (TT Data)

If some failure occurs in input signals or the processor circuits, an alarm will be issued. If an alarm is issued in the Target Tracking function, [TT(Data)] is displayed in the alarm indication and nothing is displayed in the indication of the target tracking information. Its cause is inferred that the Target Tracking function is malfunctioned. In that case, please consult with our branch office, branch shop, sales office, or our distributor in your district to repair it.

Target Tracking function Alarm

Alert characters	Alarm sound	Condition
TT (Data)	Beep sound (pipi)	If the Target Tracking function has some abnormal condition, this alarm issues.

6.7.5 Gyro set notification (Set Gyro)

The GYRO I/F in this system receives signals from a gyro. Even if the power is turned off, the system will follow up the gyro. However, the system stops the follow-up operation when the power of the master gyro is turned off or when any trouble occurs to the line. When the power of the master gyro is recovered, the [Set Gyro] notification will be issued.

When this notification is issued, set the true bearing value of the gyro. For the details, refer to “5.4.13 True bearing”.

Gyro Set Notification

Alert characters	Alarm sound	Conditions
Set Gyro	Beep sound (pi-)	The signals from the gyro are stopped, but the gyro is recovered.

6.8 Track Function

6.8.1 Setting the Past position

- 1 Select the track display interval time from the past position interval selector combo box for other ship information at the upper right of PPI.

The past position is set.

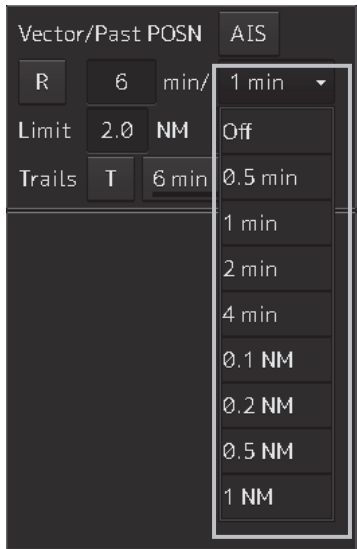

[Off] : Tracks are not displayed.

[Numeric] : Tracks are displayed at intervals of the specified value.

The past position function can display up to ten past positions of a target under tracking. The past position display interval can be set to specified time intervals of 0.5, 1, 2, or 4 minutes, or specified range intervals of 0.1, 0.2, 0.5, or 1 NM.

When [Off] is displayed, the track display function is turned off.

The track mode operates in conjunction with the vector mode, and a true or relative track is displayed.

In relative vector mode, the relative tracks of the target are displayed.

In true vector mode, true tracks that are calculated from the relative bearing, range, own ship's course, and speed are displayed.

Note

When the target is acquired, past position of traced target is start plot. When the AIS target is displayed, past position of AIS target is start plot. If the past position plotted time or range is short, the indicated past position duration may not have achieved the specified time or range.

6.8.2 Setting the other ship's tracks

This function makes settings for the tracks of tracked targets and AIS targets.

This equipment can display the tracks of up to 20 target ships.

6.8.2.1 Setting track color

For the details on how to set the track color of tracked target, refer to "6.5.6.2 Setting track color of tracked target"

For the details on how to set the track color of AIS target, refer to "6.6.6.1 Setting track color of AIS target"

6.8.2.2 Turning on/off other ship's track function

For the details, refer to "18.11 Setting the Target Track Function to ON/OFF ".

Note

Note that when this function is turned off, all the other ship's track functions are turned off. In this case, the track data of other ships is not saved, so they cannot be traced later.

6.8.2.3 Setting other ship's track colors

You can set either one track color for all targets under tracking, or individual colors for the ships of track numbers from 1st to 10th. The same color is used to display the 11th to 20th ships.

For the details, refer to "16.2.8 Setting up the Display of Other Ship's Track".

Note

If the other ship's track function (Target Track Function) is turned off, the track data of other ships is not saved.

6.8.2.4 Turning on/off other ship's track display

The target track display function can be turned on/off. Choices for track display are displaying/hiding the tracks of all ships and Individual (displaying the tracks of individual ships).

For the details, refer to "16.2.8 Setting up the Display of Other Ship's Track".

Note

Even when Target Track Display is turned off, the track data of other ships is saved if Track display Interval is set.

6.8.2.5 Setting up the display interval of other ship's track

A display interval of other ship's track can be set.

For the details, refer to "16.2.8 Setting up the Display of Other Ship's Track".

Note

This function is not available when the Target Track Function is turned off.

6.8.2.6 Clearing other ship's track

The other ship's track can be cleared by setting a color or a track number.

For the details, refer to "16.2.8 Setting up the Display of Other Ship's Track".

6.8.2.7 Saving and loading other ship's track data

Other ship's track data can be saved on HDD and load from the HDD.

(Data can be saved to HDD until the data volume becomes full.)

For the details, refer to "3.20.2 File management".

6.9 Entering Own Ship's AIS Voyage Data

Set the own ship's AIS voyage data.

- 1 Click on the [Menu] button on the left toolbar.
The menu is displayed.
- 2 Click on [TT/AIS] - [AIS Voyage Data] on the menu.
The [AIS Voyage Data] dialog box appears.

In the [AIS Voyage Data] dialog box, information collected from AIS is displayed.

- 3 Enter information manually if not being displayed, or change the information being displayed.

Item	Setting
Destination	Enter the destination in the [Destination] input box (maximum 20 characters), or display the history list and click on the destination to enter.
ETA (UTC)	Click on the calendar icon  to display the date picker, and enter the expected date (and time) of arrival by clicking.
NAV Status	Select the [Navigation Status] from the combo box. For the details of Navigation Status, refer to "6.6.4 Displaying AIS information".
Draft	Enter the draft in the [Draft] input box in the range between 0 and 25.5 m. The draft can be entered in increments of 0.1 m. If the draft is more than 25.5 m, enter 25.5 m.
Cargo category	Select the cargo category from the combo box.
Persons on-board	Enter the number of persons on board in the [Persons on-board] input box in the range between 0 and 8191. If the number of persons on board is more than 8191 persons, enter 8191.

- 4 Click on the [Send] button to save the input information.

6.10 Editing and Sending AIS Messages

AIS messages can be edited and sent.

1 Click on the [Menu] button on the left toolbar.

The menu is displayed.

2 Click on [TT/AIS] - [Edit and Send AIS Message] on the menu.

The [Edit and Send AIS Message] dialog box appears.

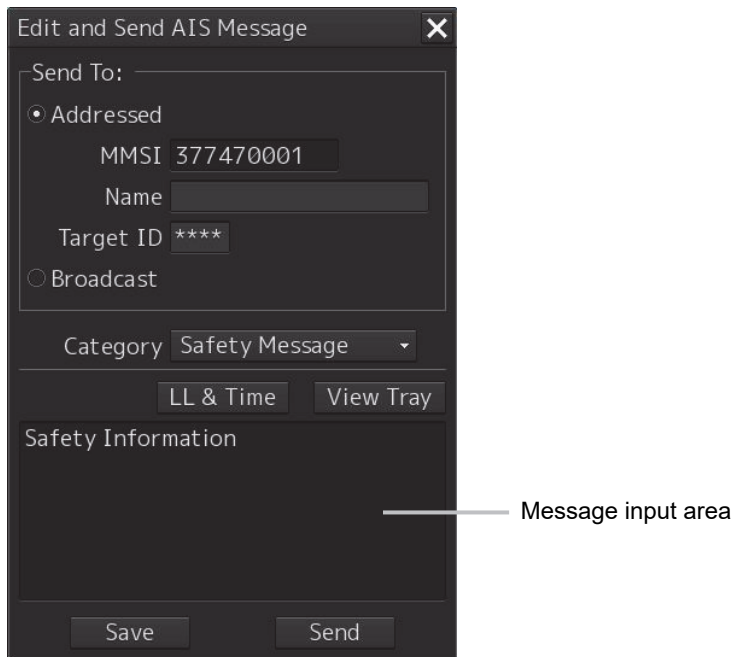

3 Specify whether a message will be sent by specifying an MMSI code or distributing a broadcast message.

For the details, refer to "To send a message by specifying an MMSI code:" and "To distribute a broadcast message:".

4 Display the [Message Category] list and select the type of the message to send.

To send a safety related message: Click on [Safety Message].

To send a routine message: Click on [Routine Message].

5 Type a message in the message input area.

To automatically enter own ship's latitude/longitude/UTC:

Click on the [LL&Time] (latitude/longitude/time) button.

To copy an existing message:

Click on the [View Tray] button to display the contents of the AIS Message Tray. Select the message to copy to display it, and then copy it. The message can be copied from the beginning up to the maximum number of characters.

Note

The maximum number of characters that can be input changes depending on the transmission method and the message type.

- Sending a message by specifying the MMSI code
 - Safety message: Up to 156 characters
 - Routine message: Up to 151 characters
- Distributing a broadcast message
 - Safety message: Up to 161 characters
 - Routine message: Up to 156 characters

6 Click on the [Send] button to send the message.

The message transmission confirmation dialog box appears.

When sending a message by specifying an MMSI code:

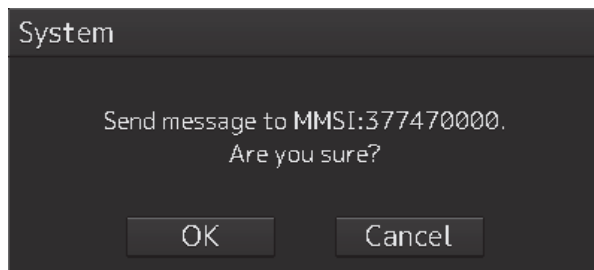

When distributing a broadcast message:

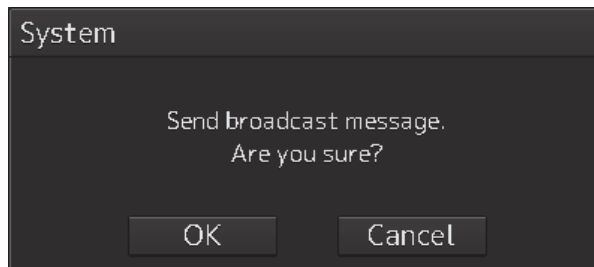
**7 Click on the [OK] button to send the message.**

To cancel the transmission of the message, click on the [Cancel] button.

The following dialog box appears while sending a message.

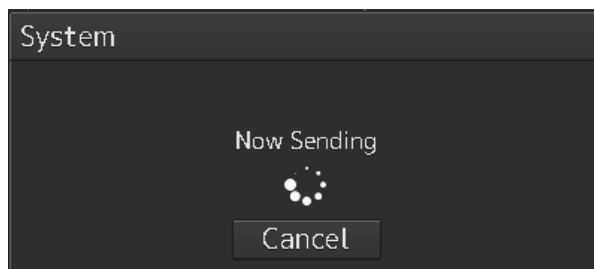

The transmission of the message currently in progress can be stopped by clicking the [Cancel] button.

The following dialog box appears when the transmission of a message completes.

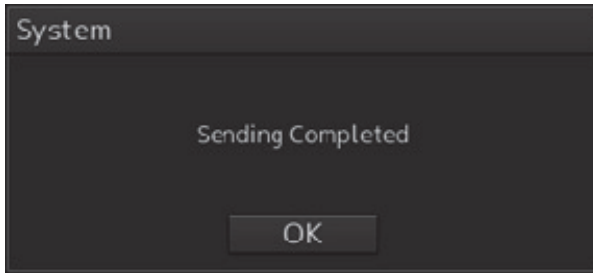

- 8** Click on the [OK] button to close the dialog box.
- 9** To save an MMSI code and a typed message in the case of MMSI transmission, click on the [Save] button.
- 10** Click on the [x] button to close the dialog box.

To send a message by specifying an MMSI code:

- 1** Click on the [Addressed MMSI] (specified MMSI code) button.
- 2** Type an MMSI code (9 digits) in the [MMSI] input box.
The name of the ship having the entered MMSI code is displayed in the [Name] box.
The identification number is displayed in the [Target ID] box.
- 3** Type a message in the message input area.
In the case of a safety related message: Maximum 156 characters
In the case of a routine message: Maximum 151 characters

To distribute a broadcast message:

- 1** Click on the [Broadcast] button.
- 2** Type a message in the message input area.
In the case of a safety related message: Maximum 161 characters
In the case of a routine message: Maximum 156 characters

6.11 AIS Message Tray

The received, sent and saved AIS messages are displayed in AIS Message Tray in a list form.

Memo

The information reference window such as AIS message tray can be switched to standard window display or extended window display.

In this example, extended window display is used.

For the details of switching between standard window display and extended window display, refer to "2.3.2.1 Switching between a standard window and an extended window".

6.11.1 Displaying the AIS message tray

- 1 Click on the [Menu] button on the left toolbar.**
The menu is displayed.
- 2 Click on [TT/AIS] - [AIS Message Tray] on the menu.**
The "Information Reference" window appears.
- 3 Click on the [AIS MSG Tray] button.**
The AIS Message Tray is displayed.

Memo

The AIS message tray can also be displayed by clicking on the [View Tray] button in the [Edit and Send AIS Message] dialog.

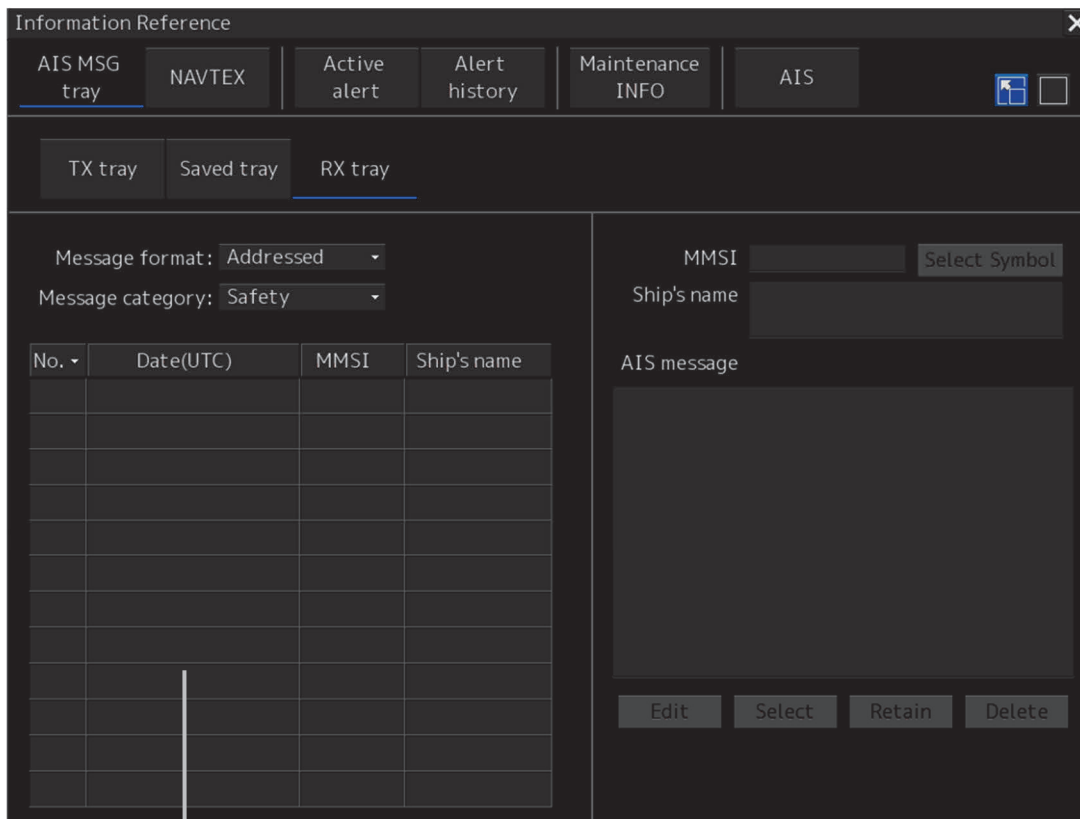

Message list

Up to 50 most recent messages are displayed in the message list, from the newest date first. When the 51st message is registered, the message having the oldest date will automatically be deleted.

By clicking any item of the title columns, messages can be sorted in ascending or descending order.

When a message is clicked in the message list, the detailed information of that message will be displayed in the right area of the list.

6.11.2 Switching message display

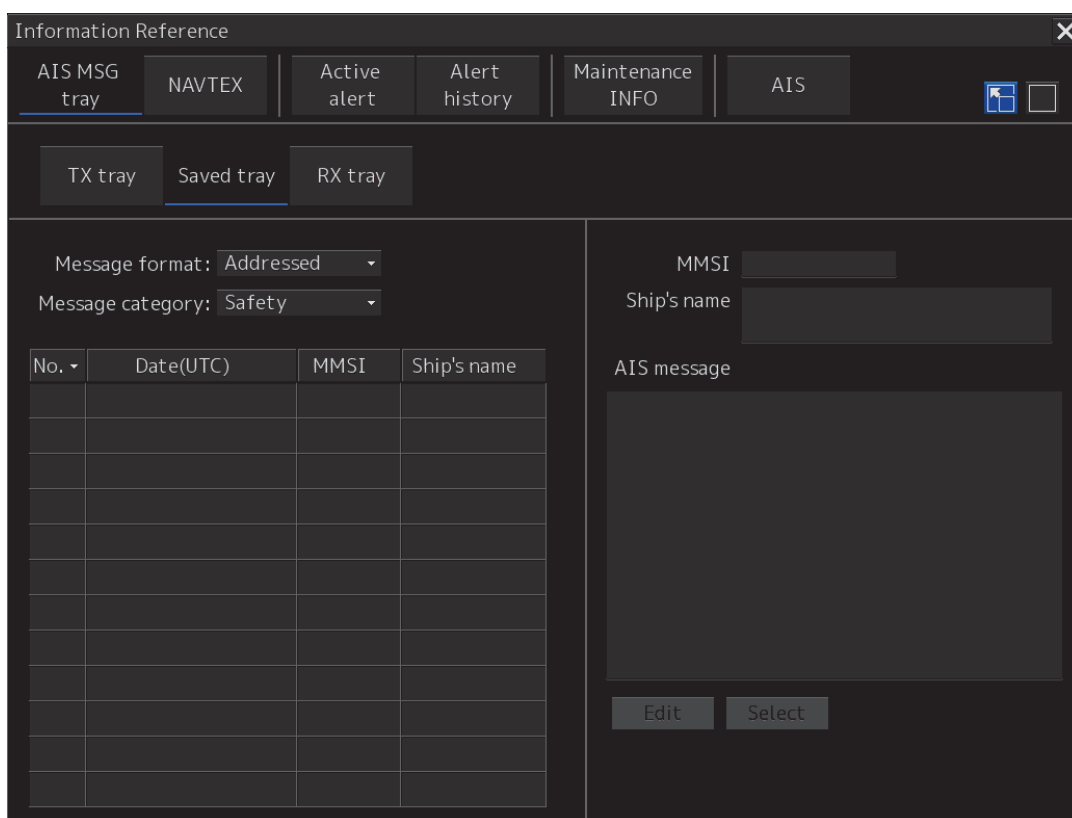

To display transmitted messages:

Click on the [TX Tray] (Transmitted Tray) button.

To display saved messages:

Click on the [Saved Tray] button.

To display received messages:

Click on the [RX Tray] (Received Tray) button.

Unread messages are displayed in boldface.

To filter messages by specifying the transmission method:

To display only messages sent/received by specifying an MMSI code:

Click on the [Addressed] (address specification) button.

To display only messages distributed through broadcasting: Click on the [Broadcast] button.

When messages are not filtered by the transmission method: Click on the [All] (display all) button.

How to select the target by searching with MMSI from the displayed AIS symbol method:

Click on the [Select Symbol] button.

If the capacity is exceeded the following rules will be to organize the message.

Message Type		Message Organizing Rules.
	Max	
Safety Related Address specification	20	(For each AIS type) Delete the oldest message.
Safety Related Broadcast	20	(For each AIS type) Delete the oldest message.
Safety Related (Retained)	20	(For each AIS type) Delete the oldest message from retained and move It to address or broadcast. If it is exceeded at that time, delete the oldest message.
Routine Message	50	(For routine message) Delete the oldest message.

To filter messages by specifying category:

To display only safety related messages: Click on the [Safety] (safety related) button.

To display only routine messages: Click on the [Routine] button.

When messages are not filtered by category: Click on the [All] (display all) button.

6.11.3 Sending a message in the message tray after editing

1 Click the message to copy in the message list.

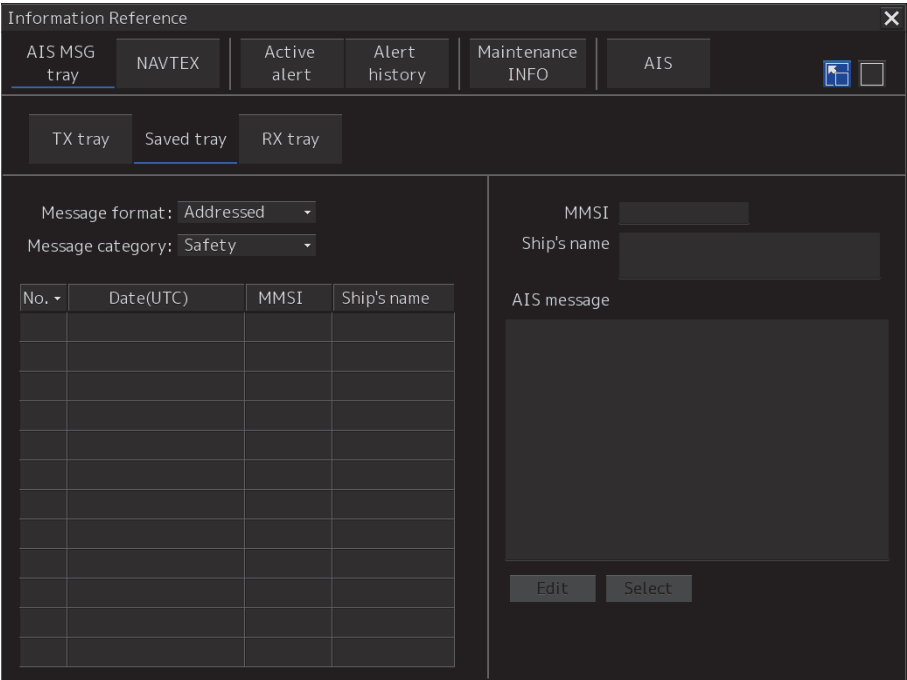

2 Click on the [Edit] or [Select] button.

When the AIS Message Tray is displayed by opening the AIS Message Tray submenu: Click the [Edit] button.

The [Edit and Send AIS Message] dialog box appears, and the AIS message will be copied to the [Edit and Send AIS Message] dialog box. When a message is sent by specifying an MMSI code, the MMSI code will also be copied:

When the AIS Message Tray was displayed by clicking the [View Tray] button in the [Edit and Send AIS Message] dialog box: Click the [Select] button.

The AIS message will be copied to the [Edit and Send AIS Message] dialog box. The MMSI code is not copied by this method.

6.12 Highlighting TT/AIS Symbols

TT/AIS symbols can be searched by specifying criteria and highlight them.

- 1 Click on the [Menu] button on the left toolbar.

The menu is displayed.

- 2 Click on [TT/AIS] - [Highlighting] on the menu.

The [Highlighting] dialog box appears.

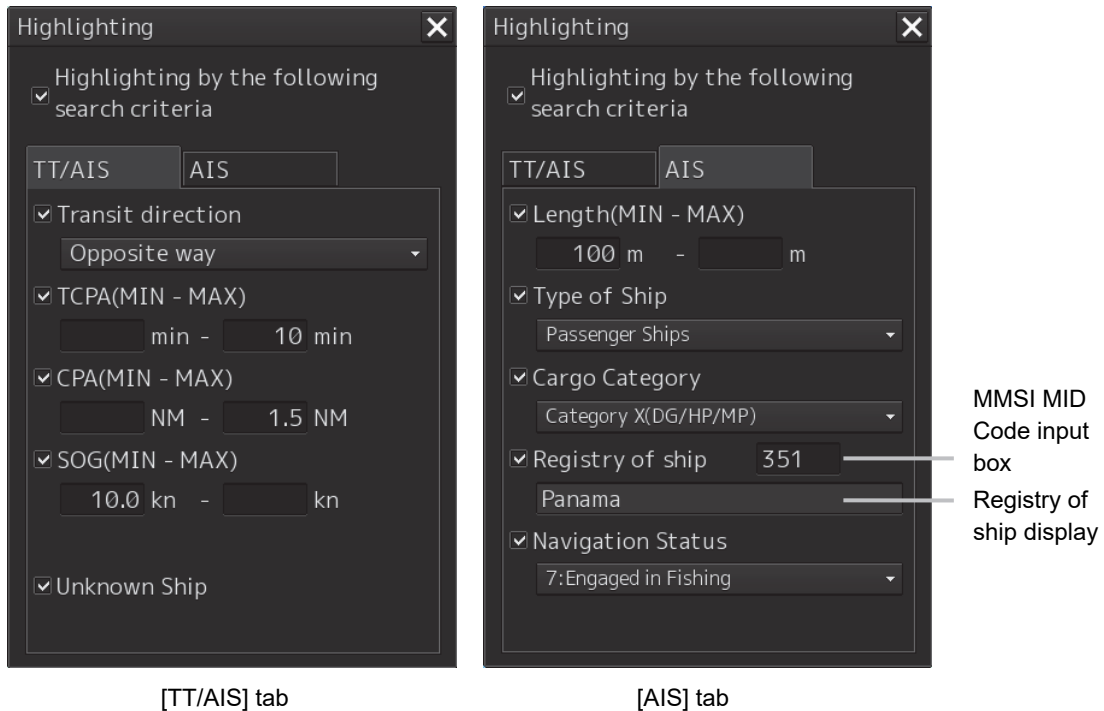

- 3 To include all search criterions as highlight targets, select the [Highlighting by the following search criteria] checkbox.

To exclude all search criterions from highlight targets, clear the [Highlighting by the following search criteria] checkbox.

- 4 If the [Highlighting by the following search criteria] checkbox is selected in step 3 above, clear the checkboxes of the search criterion to be excluded from highlighting.

5 Of the checked search items, specify the search criteria for highlighting.

[Transit direction]: Select the transit direction from the combo box.

N	Sailing North
NE	Sailing North East
E	Sailing East
SE	Sailing South East
S	Sailing South
SW	Sailing South West
W	Sailing West
NW	Sailing North West
Same way	Same way
Opposite way	Opposite way

Item	Setting
TCPA	Specify the minimum and maximum values in the range between 1 to 99 min.
CPA	Specify the minimum and maximum values in the range between 0.1 to 9.9 NM.
SOG	Specify the minimum and maximum values in the range between 0.0 to 1022.2 kn.
Unknown Ship	As a result of conducting association processing using the TT/AIS function, targets that were not identified will be categorized as unknown ships.
Length	Specify the minimum and maximum values in the range between 1.0 to 1022.0 m.
Type of ship	Open the list and click on the type of the ship to be highlighted.
Cargo category	Open the list and click on the cargo category to be highlighted.
Registry of ship	Specify the MMSI MID Code in the range between 200 and 800. The registry of ship corresponding to the entered code is displayed.
Navigation Status	Open the list and select the navigation status to be highlighted.

6.13 Trial Maneuvering

Note

- Trial maneuvering is to simulate own ship's course and speed in the conditions that the course and speed of a target ship are unchanged as they are. The situation is different from any actual ship maneuvering, so set values with large margins to CPA Limit and TCPA Limit.
- During trial, the CPA/TCPA (TT) alarm cannot be approved. To approve the alarm, terminate the trial.

6.13.1 Outline of Trial Maneuvering

The trial maneuvering is the function of simulating own ship's course and speed for collision avoidance when a dangerous target appears. When the own ship's course and speed are entered in manual mode, the trial maneuvering function checks if pre-acquired or pre-activated targets are dangerous.

Trial maneuvering in the true vector mode

If the own ship's vector mode is the true vector mode, the own ship's vector is calculated according to the own ship's trial speed and trial course as well as the own ship's dynamic characteristic, and the result is displayed as the own ship's expected course. The following figures show an example of veering to the left: the dangerous target at front right has changed to a safe target as a result of trial maneuver.

The tracked target information indicates the current CPA and TCPA values regardless of the result of simulation.

NORMAL

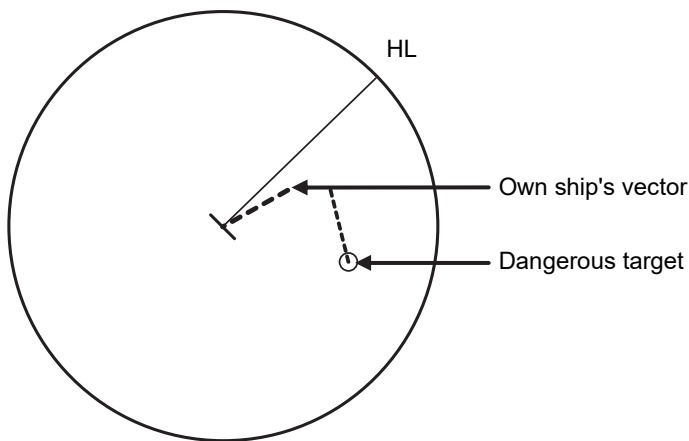

TRIAL

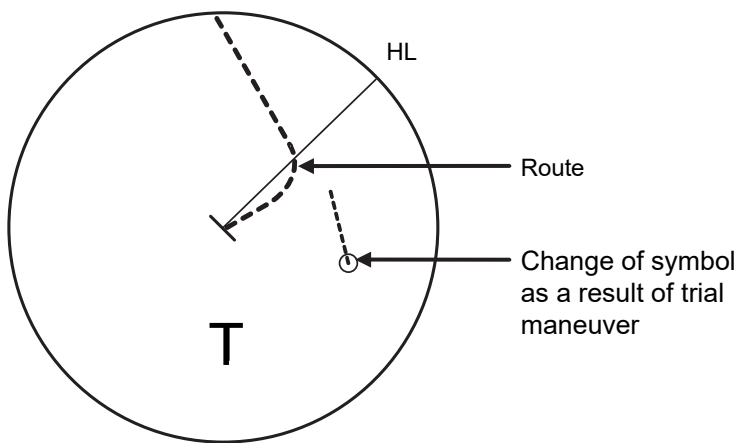

Trial Maneuvering in the True Vector Mode

Trial maneuvering in the relative vector mode

If the own ship's vector mode is the relative vector mode, an expected relative course of the target is displayed in relation to the own ship's expected course when in the true vector mode. The following figures show an example of a dangerous target changing to a safe target. The target vector will cross the CPA ring and will thus be a dangerous target. By trial maneuver of ship avoidance simulation (under the same condition as the true vector in the previous section), the relative vector (expected course) of the target changes to a safe target as shown in the lower figure.

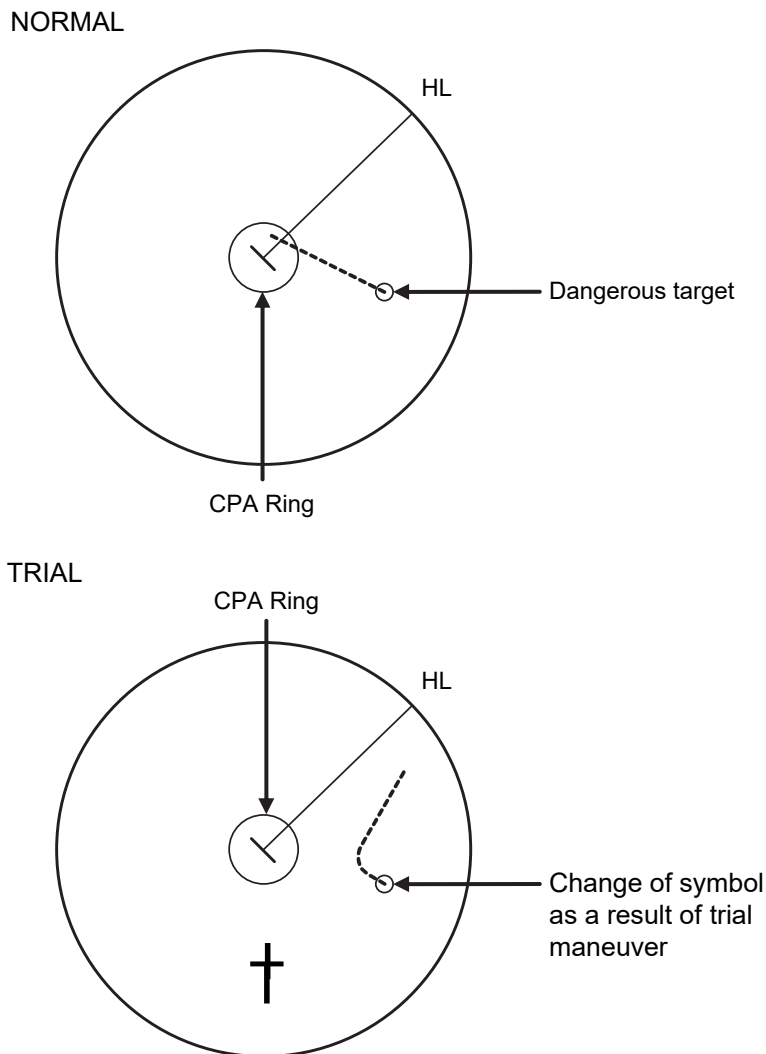

Trial Maneuvering in the Relative Vector Mode

The above figure shows that the relative vector of the target has changed as shown in the Figure as a result of simulation (course and speed) in the previous section, so that the symbol color is changed into "White", a safe target.

Irrespective of the simulation results, the current CPA and TCPA values are shown in the tracked target information just like when the true vector mode is active.

The course change of own ship is displayed as a dotted-line.

Better information is provided by using the trial relative vector mode when sea stabilization mode is active.

6.13.2 Performing a trial maneuver

- 1 Click on the [Menu] button on the left toolbar.

The menu is displayed.

- 2 Click on [TT/AIS] - [Trial Maneuver] on the menu.

The [Trial Maneuver] dialog box appears.

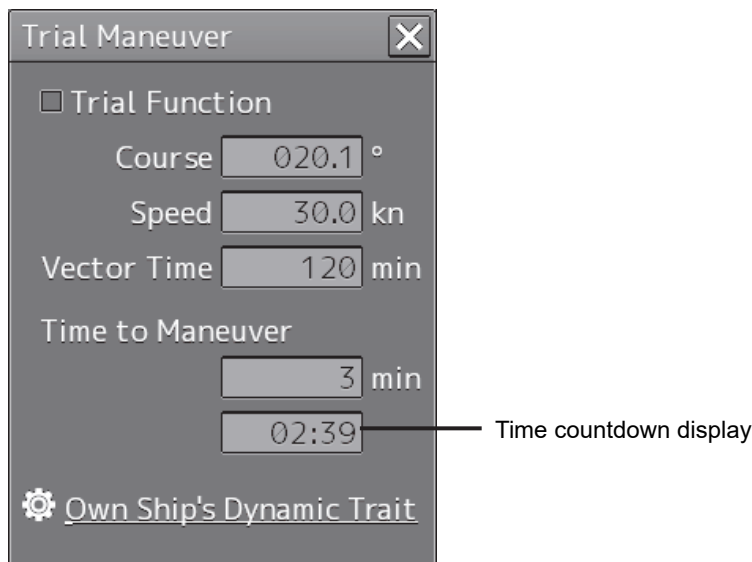

- 3 Select the [Trial Function] checkbox.

The trial function is turned on.

When Trial Function is set to On, the character "T" blinks at the bottom of the own ship display field in the radar display and means a trial maneuver.

- 4 Enter a setting value in each of the [Course] and [Speed] input boxes.

Memo

[Course] can be set up by turning the [EBL] dial and [Speed] by turning the [VRM] dial.

- 5 Set other characteristics.

[Vector Time]: Vector time (1 to 120 min)

[Time to Maneuver]: Time until trial maneuvering is started (0 to 30 min)

[Own Ship's Dynamic Trait]:

When this item is clicked, the dialog is displayed to set own ship's dynamic trait.

For the details, refer to "18.8 Setting own ship's dynamic trait".

For the settings of [Own Ship's Dynamic Trait], refer to "18.5.2 Setting own ship's dynamic trait". The dangerous target symbol is displayed in red and the safe target symbol is displayed in white.

The color of the safe target symbol can be changed with [Target Symbol] of [Settings] - [General] - [Color and Brightness]. For the details, refer to "18.19 Setting Colors and Brightness".

Vector Time is valid only when Trial Function is set to On. If it is Off, the vector time before trial maneuvering is displayed.

Time until the start of trial maneuvering is counted down directly after the input.

The acceleration and deceleration are influenced depending on the relationship between the current speed and the input speed for trial maneuvering.

If 0.0 kn/min is set for [Acceleration] when the speed for trial maneuvering is faster than the current speed, or for [Deceleration] when the speed for trial maneuvering is slower than the current speed, the system performs simulation on the assumption that the speed is changed directly after the time set for [Time to Maneuver].

To finish trial operation:

- 1 Clear the [Trial Function] checkbox.**

6.14 Displaying the TT/AIS Target List

The information of targets being monitored with the TT and AIS functions can be displayed in a list on the information monitoring window.

6.14.1 Displaying TT/AIS List

Take the following steps to display the TT list and AIS list.

1 Click on the [Menu] button on the left toolbar.

The menu is displayed.

2 Click on [TT/AIS] - [TT/AIS List] on the menu.

The "TT/AIS" list is displayed in the information monitoring window.

- In RADAR, the [TT List] button is displayed. Clicking on the button displays TT information.
- In ECDIS, the [TT1 List] and [TT2 List] buttons are displayed. Clicking on these buttons display TT1 and TT2 information.
- Clicking on the [AIS List] button displays AIS information.

When [BRG/RNG] is clicked, the Bearing and Range of the target from the own ship are displayed as the other ship's position in the row of the list.
When [Lat/Lon] is clicked, Lat and Lon (latitude/longitude) is displayed as the other ship's position in the row of the list.

ID	CPA[NM]	TCPA[min]	BCR[NM]	BCT[min]	COG[°]	SOG[kn]	BRG[°]	RNG[NM]	Status
1	8.17	-Over			030.6	10.0	041.0	8.48	Selected
4	8.38	-Over			031.0	10.1	153.6	8.85	Selected
3	4.99	0.00			029.7	10.0	175.0	4.99	ACQ
2	4.78	0.00			030.1	10.0	089.0	4.77	ACQ

6.14.1.1 Switching between a standard window and an extended window

The TT/AIS list can be switched to a standard window or an extended window.

To switch to an extended window, click on the List extension button.

To switch to a standard window, click on the List Standard button.



[Example of Extended window]

The screenshot shows the 'TT/AIS List' window in its extended view. It features a table with 11 columns: ID, CPA[NM], TCPA[*min*] - , BCR[NM], BCT[*min*], BRG[°], RNG[NM], HDG[°], LAT, LON, and Status. The table contains 8 rows of data, all with a 'Sleeping' status. Below the table is a 'Show AIS Detail' button.

ID	CPA[NM]	TCPA[<i>min</i>] -	BCR[NM]	BCT[<i>min</i>]	BRG[°]	RNG[NM]	HDG[°]	LAT	LON	Status
8	2.12	12.48	2.12	12.6	315.4	2.98	090.0	0°02.121'N	0°02.079'W	Sleeping
7	2.12	12.48			224.6	2.98	090.0	0°02.121'S	0°02.080'W	Sleeping
1	0.00	17.74			270.0	2.98	090.0	0°00.000'N	0°02.957'W	Sleeping
2	3.00	-0.24			000.8	3.00	090.0	0°03.000'N	0°00.041'E	Sleeping
6	3.00	-0.25			179.2	3.00	090.0	0°03.000'S	0°00.042'E	Sleeping
3	2.12	-12.99			045.8	3.04	090.0	0°02.121'N	0°02.164'E	Sleeping
5	2.12	-12.99			134.2	3.04	090.0	0°02.121'S	0°02.164'E	Sleeping
4	0.00	-18.25			090.0	3.06	090.0	0°00.000'N	0°03.042'E	Sleeping

[Example of standard window]

ID	CPA[NM]	TCPA[min]	CTW[°]	STW[kn]
8	2.12	12.21	090.0	10.0
7	2.12	12.21	090.0	10.0
1	0.00	17.49	090.0	10.0
2	3.00	-0.51	090.0	10.0
6	3.00	-0.52	090.0	10.0
3	2.12	-13.24	090.0	10.0
5	2.12	-13.24	090.0	10.0
4	0.00	-18.52	090.0	10.0

Scroll bar

By dragging the scroll bar, the overlapped section can be displayed.

Memo

A standard window is displayed at the initial display.

When the RADAR transmission status is Transmit in RADAR mode, the extended window cannot be displayed.

6.14.2 TT List

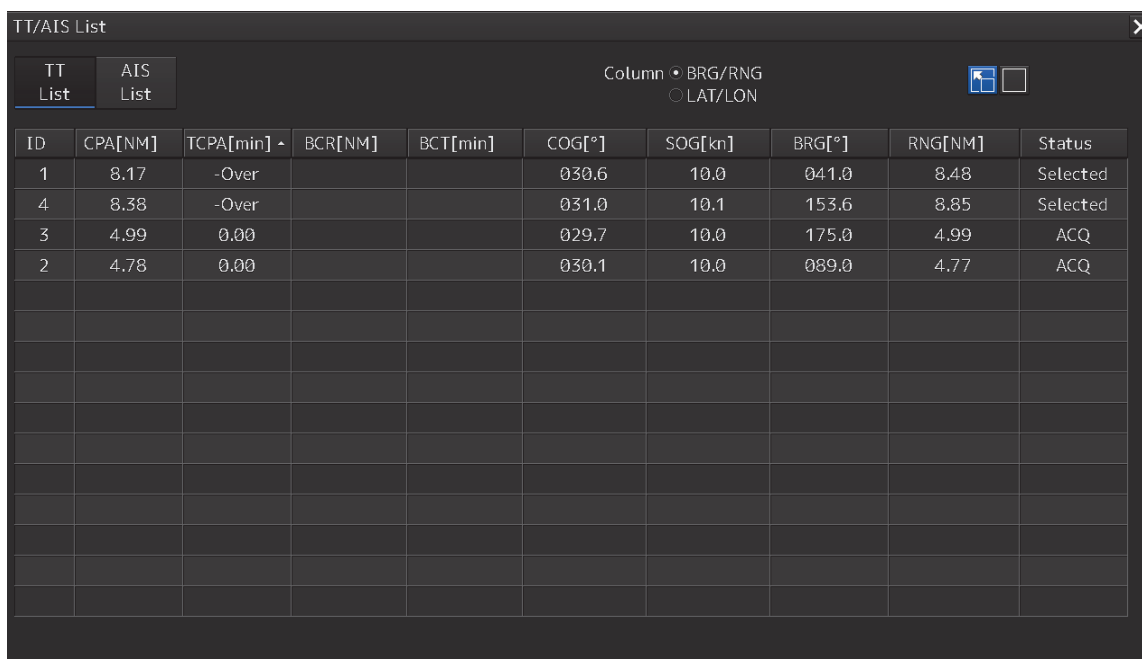

ID	CPA[NM]	TCPA[min]	BCR[NM]	BCT[min]	COG[°]	SOG[kn]	BRG[°]	RNG[NM]	Status
1	8.17	-Over			030.6	10.0	041.0	8.48	Selected
4	8.38	-Over			031.0	10.1	153.6	8.85	Selected
3	4.99	0.00			029.7	10.0	175.0	4.99	ACQ
2	4.78	0.00			030.1	10.0	089.0	4.77	ACQ

Display Example

Item	Description
ID	ID No. of tracked target
CPA	Closest approach distance
TCPA	Time up to closest approach distance
BCR	Bow crossing distance
BCT	Bow crossing time
COG or CTW	COG: Course Over the Ground CTW: Course Through Water *In ground mode, COG is displayed. In water mode, CTW is displayed. *Operates in fixed ground mode on the ECDIS screen.
SOG or STW	SOG: Speed Over the Ground STW: Speed Through Water *In ground mode, SOG is displayed. In water mode, STW is displayed. *Operates in fixed ground mode on the ECDIS screen.
BRG	True direction
RNG	Distance
Lat	Latitude
Lon	Longitude
Status	Status Initial ACQ: Initial acquisition in progress Tracking: Acquisition in progress Lost: Lost status Danger: Dangerous ship

Memo

When the TT list is displayed initially, the items are sorted in the order of TCPA. When the sequence is changed, the items are displayed in the last sort sequence.

6.14.3 AIS List

When [CTW/STW/Name/Call Sign/MMSI/Source] is clicked, CTW, STW, Name, Call Sign, MMSI, and Source are displayed in the rows of list.

When [BCR/BCT/BRG/RNG/HDG/POSN/Status] is clicked, BCR, BCT, Bearing, Range, Heading, Lat, Lon, and Status are displayed in the row of list.

ID	CPA[NM]	TCPA[min]	COG[°]	SOG[kn]	Name	Call Sign	MMSI	Source
1	1.81	1.63	000.0	1.0	SHIPNAME-377470000	JRC0001	377470000	Direct
2	0.38	10.42	072.0	1.0	SHIPNAME-377470001	JRC0002	377470001	Direct
3	2.04	-1.84	144.0	1.0	SHIPNAME-377470002	JRC0003	377470002	Direct
5	1.23	-11.34	288.0	1.0	SHIPNAME-377470004	JRC0005	377470004	Direct
4	0.91	-12.68	216.0	1.0	SHIPNAME-377470003	JRC0004	377470003	Direct

Display Example

Item	Description
ID	ID No. of AIS
CPA	Closest approach distance
TCPA	Time up to closest approach distance
COG or CTW	COG: Course Over the Ground CTW: Course Through Water *In ground mode, COG is displayed. In water mode, CTW is displayed. *Operates in fixed ground mode on the ECDIS screen.
SOG or STW	SOG: Speed Over the Ground STW: Speed Through Water *In ground mode, SOG is displayed. In water mode, STW is displayed. *Operates in fixed ground mode on the ECDIS screen.
Name	Ship name
Call Sign	Call sign
MMSI	Maritime Mobile Service Identity
Source	AIS information source - Direct - Repeated - VTS
BCR	Bow crossing distance
BCT	Bow crossing time

Item	Description
BRG	True direction
RNG	Distance
HDG	Heading
Lat	Latitude
Lon	Longitude
Status	Status Sleeping: Sleeping in progress Active: Activation in progress Lost: Lost status Danger: Dangerous ship
[Show AIS Detail] button	When one item is selected from the list and this button is clicked, AIS detail information is displayed in the information monitoring window. For the details, refer to "2.3.1.4 AIS Detail INFO".

6.15 Confirming Own Ship's AIS Information

Take the following steps to display own ship's AIS information.

- 1 Click on the [Menu] button on the left toolbar.**
The menu is displayed.
- 2 Click on [TT/AIS] - [Own Ship AIS Data] on the menu.**
The "Information Reference" (information reference window) is displayed.
- 3 Click on the [Own Ship AIS Data] button.**
Own ship's AIS information is displayed in the information reference window.

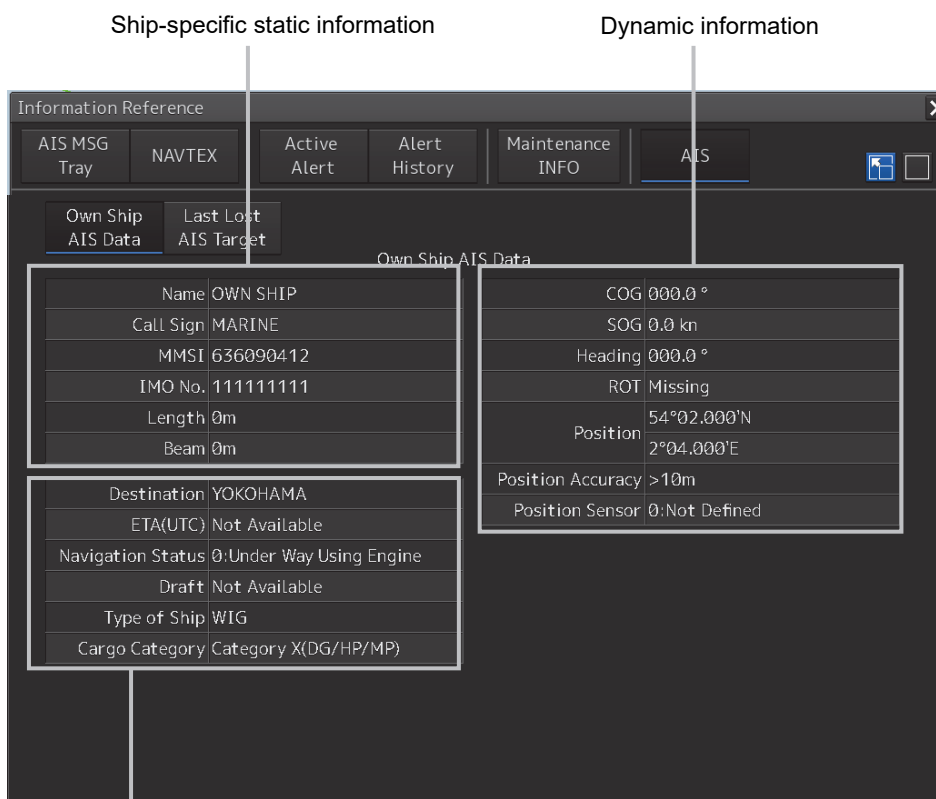

Static information that may change during each navigation

Memo

The Information Reference can be switched to standard window display or extended window display.

In the above example, the extended window is used.

For the details of switching between the standard window and the extended window, refer to "2.3.2.1 Switching between a standard window and an extended window".

6.16 Displaying the Last Lost AIS Target

- 1 Click on the [Menu] button on the left toolbar.**
The menu is displayed.
- 2 Click on [TT/AIS] - [Last Lost AIS Data] on the menu.**
The "Information Reference" (information reference window) is displayed.
- 3 Click on the [Last Lost AIS Target] button.**
The last lost information about AIS target is displayed in the reference monitoring window.

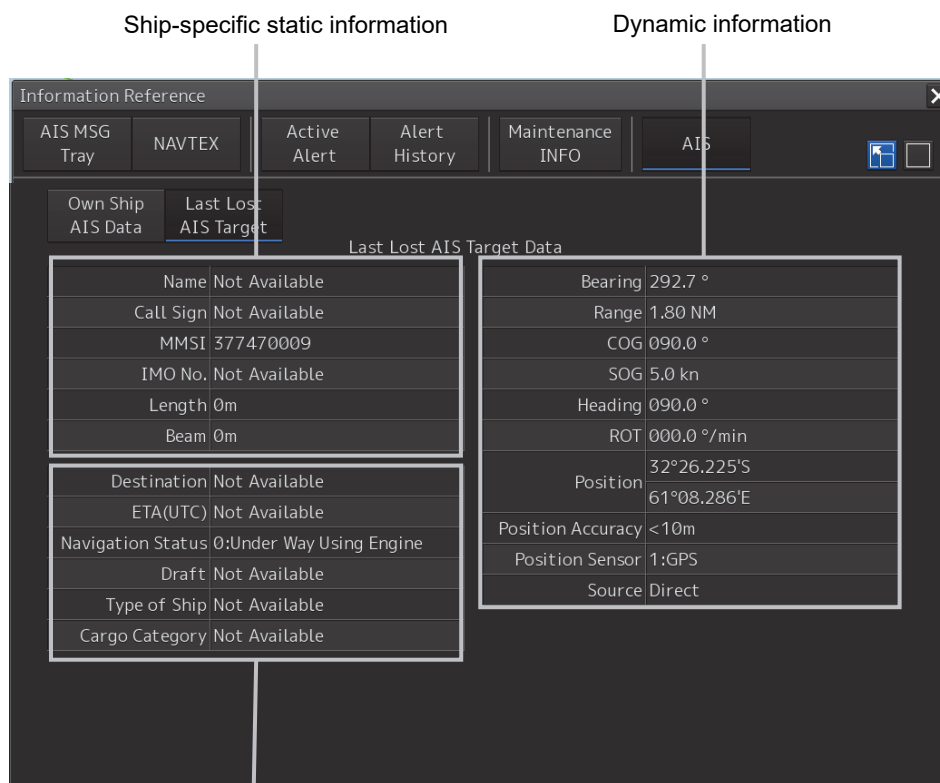

Static information that may change during each navigation

Last Lost AIS Target (last lost information about AIS target)

Displayed information	Explanation
Name	Displays the ship name of an AIS target.
Call Sign	Displays a call sign.
MMSI	Displays a nine-digit identification number for a ship/ground station equipped with a DSC communication device.
IMO No.	Displays the 9-digit IMO number.
Length	Displays the length of an AIS target.
Beam	Displays the beam of an AIS target.
Destination	Displays the destination of an AIS target.
ETA or UTC	Displays the expected arrival time of an AIS target.

Displayed information	Explanation
Navigation Status	Displays the navigation conditions of an AIS target. 0: Under Way Using Engine 1: At Anchor 2: Not Under Command 3: Restricted Maneuverability 4: Constrained by Her Draft 5: Moored 6: Aground 7: Engaged in Fishing 8: Under Way Sailing 9: Reserved for High Speed Craft 10: Reserved for Wing In Ground 11: Reserved 15: Not Defined
Draft	Displays the draft of an AIS target.
Type of Ship	Displays the ship type of an AIS target. 30: Fishing Vessel 31: Towing Vessel 32: Towing Vessel>200MB->25M (Towing and length of the tow exceeds 200m or breadth exceeds 25m) 33: Dredge or Underwater OPE (Engaged in dredging or underwater operation) 34: Vessel-Diving OPE (Engaged in diving operation) 35: Vessel-Military OPE (Engaged in military operation) 36: Sailing Vessel 37: Pleasure Craft 50: Pilot Vessel 51: Search and Rescue Vessels 52: Tugs 53: Port Tenders 54: With Anti-Pollution Equip(Vessels with anti-pollution facilities or equipment) 55: Law Enforcement Vessels 58: Medical Transports 59: Resolution No18:MOB-83(Ships according to Resolution No18(Mob-83)) 2X: WIG(Wing-in-Ground Effect Craft) 4X: High Speed Craft 6X: Passenger Ships 7X: Cargo Ships 8X: Tanker 9X: Other Type of Ship

Displayed information	Explanation
Cargo Category	When the setting of the type of a ship is 2X, 4X, 6X, 7X, 8X or 9X, the digit shown at the end of the code represents the cargo/condition. X1 Category X(DG/HP/MP) X2 Category Y(DG/HP/MP) X3 Category Z(DG/HP/MP) X4 Category OS(DG/HP/MP) X9 No Additional Information X0 All Ships of This Type
Bearing	Displays the bearing of an AIS target.
Range	Displays the distance to an AIS target.
COG or CTW	Displays the course of an AIS target. Displayed as "COG" in the course over the ground mode and "CTW" in the course through the water mode.
SOG or STW	Displays the ship speed of an AIS target. Displayed as "SOG" in the speed over the ground mode and "STW" in the speed through the water mode.
Heading	Displays the heading of an AIS target.
ROT	Displays the turning speed of an AIS target.
Position	Displays the position of an AIS target.
Position Accuracy	When the position-fix accuracy of an AIS target is low, [>10m] is displayed. When the position-fix accuracy of an AIS target is high, [<10m] is displayed.
Position Sensor	Displays the type of the position sensor used by an AIS target. 0: Not Defined 1: GPS 2: GLONASS 3: Combined GPS/GLONASS 4: Loran-C 5: Chayka 6: Integrated Navigation System 7: Surveyed 8: Galileo 15: Internal GNSS
Source	AIS information source - Direct - Repeated - VTS

Memo

The Information Reference can be switched to standard window display or extended window display.

In the above example, the extended window is used.

For the details of switching between the standard window and the extended window, refer to "2.3.2.1 Switching between a standard window and an extended window".



Section 7 True and False Echoes on Display

The radar operator has a role of interpreting the radar displays to provide his best aid in maneuvering the ship.

For this purpose, the operator has to observe the radar displays after fully understanding the advantages and disadvantages that the radar has.

For better interpretation of radar display, it is important to gain more experiences by operating the radar equipment in fair weathers and comparing the target ships watched with the naked eyes and their echoes on the radar display.

The radar is mainly used to monitor the courses of own ship and other ships in open seas, to check buoys and other nautical marks when entering a port, to measure own ship's position in the coastal waters relative to the bearings and ranges of the shore or islands using a chart, and to monitor the position and movement of a heavy rain if it appears on the radar display.

Various types of radar display are explained below.

7.1 Radar Wave with the Horizon

Radar beam radiation has the nature of propagating nearly along the curved surface of the earth. The propagation varies with the property of the air layer through which the radar beam propagates. In the normal propagation, the distance (D) of the radar wave to the horizon is approximately 10% longer than the distance to the optical horizon. The distance (D) is given by the following formula:

$$D = 2.23(\sqrt{h_1} + \sqrt{h_2}) \text{ (NM)}$$

h_1 : Height (m) of radar antenna above sea level

h_2 : Height (m) of a target above sea level

The following figure illustrates a diagram for determining the maximum detection range of a target that is limited by the curve of the earth surface in the normal propagation.

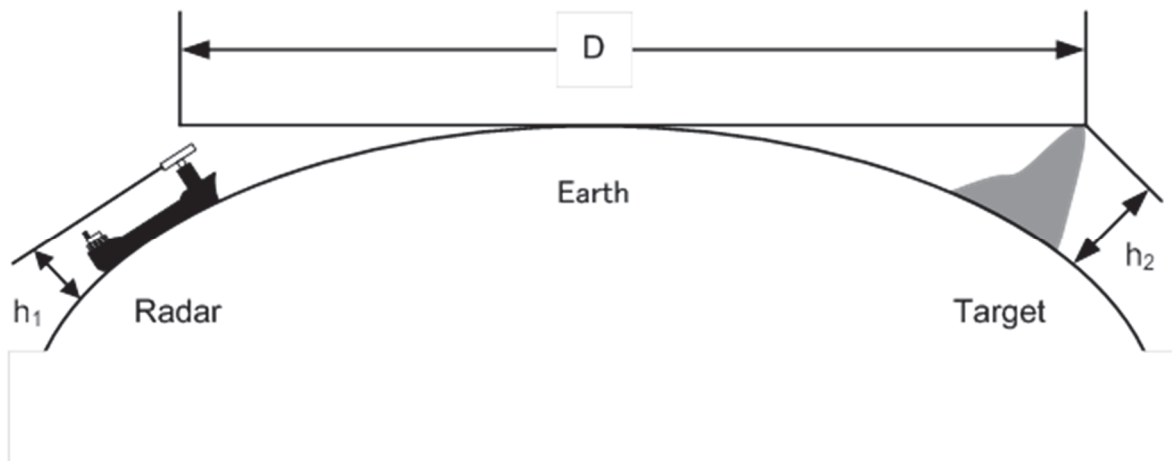

Radar Wave with the Horizon

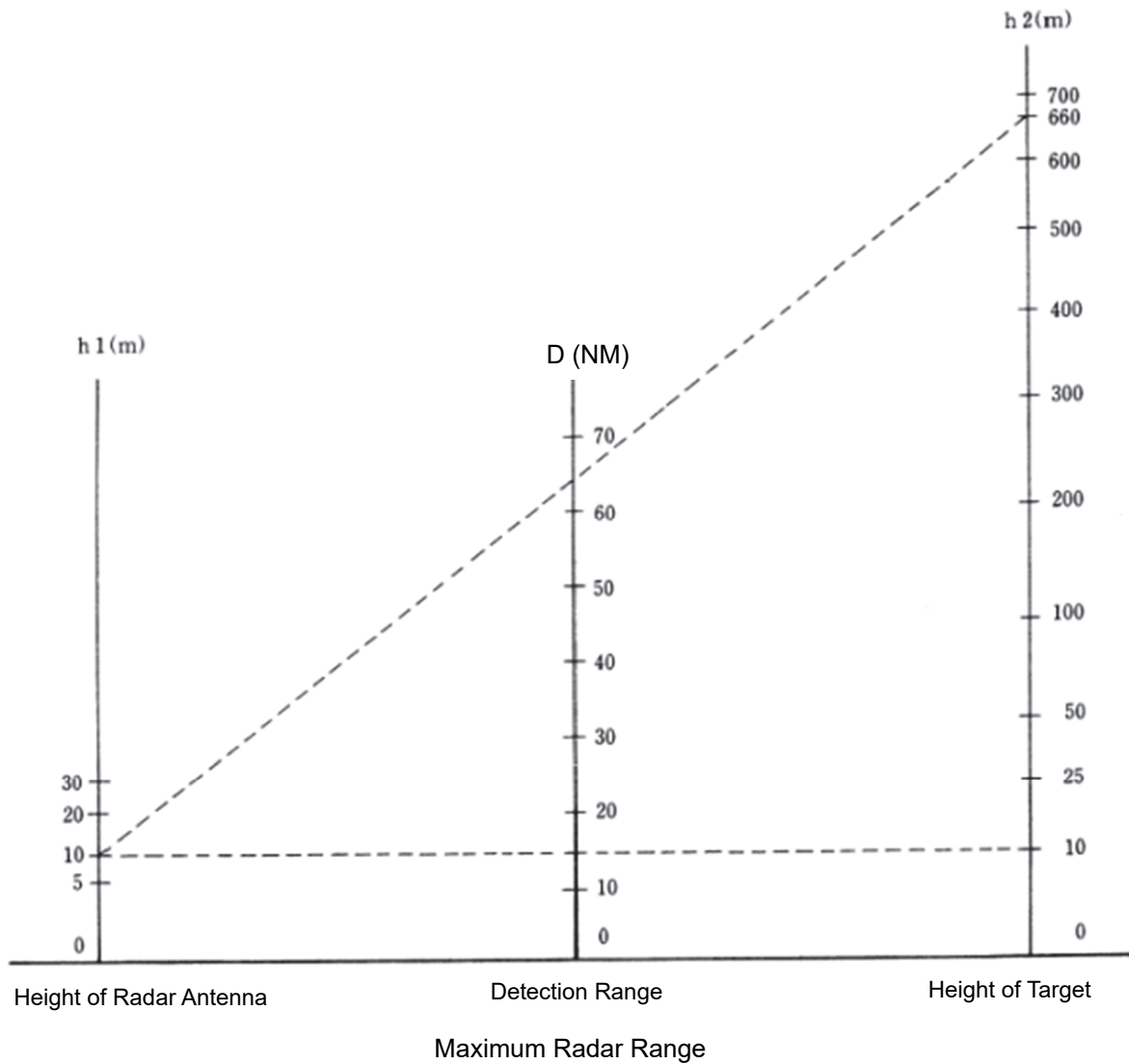

When the height of own ship's radar antenna is 10 m for instance,

- (1) A target that can be detected at the radar range of 64 NM on the radar display is required to have a height of 660 m or more.
- (2) If the height of a target is 10 m, the radar range has to be approx. 15 NM.

However, the maximum radar range at which a target can be detected on the radar display depends upon the size of the target and the weather conditions, that is, the radar range may increase or decrease depending upon those conditions.

7.2 Intensity Reflected from the Target

The signal intensity reflected from a target depends not only on the height and size of the target but also on its material and shape. The echo intensity from a higher and larger target is not always higher in general.

In particular, the echo from a coast line is affected by the geographic conditions of the coast. If the coast has a very gentle slope, the echo from a mountain of the inland like the figure below appears on the radar display. Therefore, the distance to the coast line should be measured carefully.

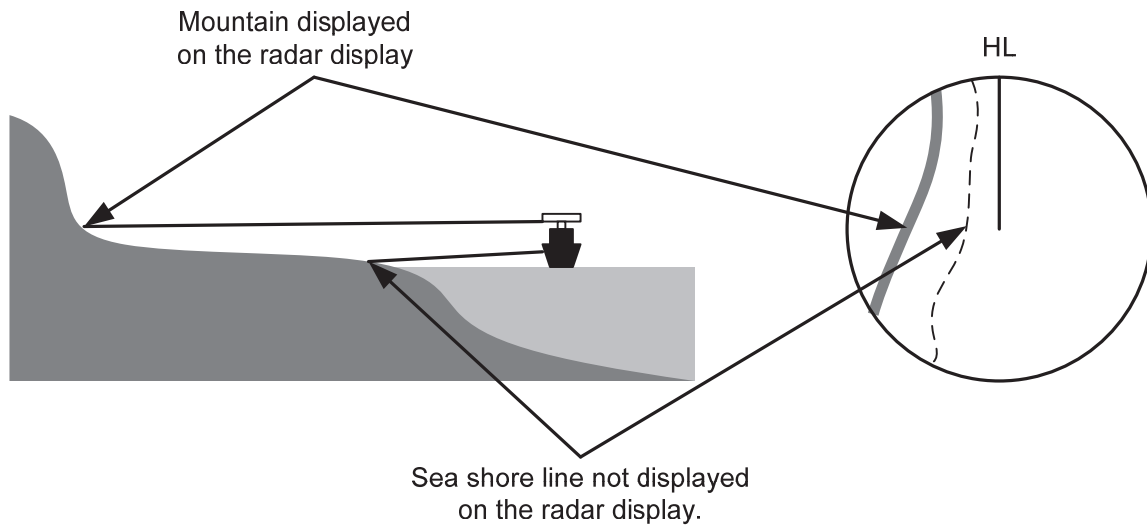

Sea Shore Line Not Displayed on the Radar Display

The next table shows the relation between the target detection range and the radar reflection cross-sectional area (RCS) with regard to the type and the height of the target in a situation in which the weather is good, the sea state is calm and the radio wave propagation is normal. As revealed by this table, even on the same sea shore line, detection range greatly differs depending on the height of the target from the surface of the sea. Furthermore, because the target detection range is greatly influenced by the shape and material of the target and environmental conditions, such as the sea state, weather, and radio wave propagation, caution should be taken when detecting range of target.

Relation between Type and Height of Target and Detection Range and RCS

Type of target	Height from sea surface (m)	Detection range (NM)		RCS (m ²)	
		X band	S band	X band	S band
Sea shore line	60	20	20	50,000	50,000
Sea shore line	6	8	8	5,000	5,000
Sea shore line	3	6	6	2,500	2,500
SOLAS target ship (>5000GT)	10	11	11	50,000	30,000
SOLAS target ship (>500GT)	5	8	8	1,800	1,000
Small boat with IMO standard compatible radar reflector	4	5.0	3.7	7.5	0.5
Marine buoy with corner reflector	3.5	4.9	3.6	10	1
Standard marine buoy	3.5	4.6	3.0	5	0.5
10-meter small boat without radar reflector	2	3.4	3.0	2.5	1.4
Waterway location beacon	1	2.0	1.0	1	0.1

Note

Detection range shown in the above table may greatly decrease depending on the shape of the target, sea state, weather and radio wave propagation conditions.

7.3 Sea Clutter and Rain/Snow Clutter

In addition to the echo required for observing ships and land, radar video image also includes undesirable echo, such as reflection from waves on the sea surface and reflection from rain and snow. Reflection from the sea surface is called "sea clutter," and reflection from rain and snow is called "rain and snow clutter," and those spurious waves must be eliminated by the clutter rejection function ([Signal Process]-[Video Noise Rejection] in the Menu. (Refer to "18.3 Performing basic adjustments on the radar".)

7.3.1 Sea clutter

Sea clutter appears as an image radiating outwardly from the center of the radar display and changing depending on the size and the shape of waves. Generally, as waves become larger, image level of the sea clutter is intensified and the clutter far away is also displayed. In this case, it is difficult to distinguish sea clutter from a small boat whose reflection intensity is weak. Accordingly, it is necessary to properly adjust the sea clutter rejection function.

The following tables show the relation between the sea state (SS) showing the size of waves generated by wind and the radar's detection probability.

Sea State and Probability of Target Detection

RCS	SS1 to 2	SS2 to 3	SS3 to 4	SS4 to 5
0.1 m ²	V	V-M	M-NV	
0.5 m ²	V	V	V-M	M-NV
1 m ²	V	V	V	V-M

S band radar (probability to detect a target at a range of 0.4 NM)

RCS	SS1 to 2	SS2 to 3	SS3 to 4	SS4 to 5
1m ²	V-M	M-NV		
5 m ²	V	V-M	M-NV	
10 m ²	V	V	V	V-M

X band radar (probability to detect a target at a range of 0.7 NM)

V: Detection probability of 80 %

M: Detection probability of 50 %

NV: Detection probability of less than 50 %

As shown in the following table, the number of SS increases as the wind speed becomes high and the waves become large. The tables in the previous page show that detection probability decreases from V (80 %) to NV (less than 50 %) as the number of SS increases. Therefore, even if the sea state is calm and a target clearly appears on the radar display, when the sea state becomes rough, target detection probability decreases resulting in difficulty of target detection by the radar.

Relation between Douglas Sea State and Average Wind Speed and Significant Wave Height

Sea state	Average wind speed (kn)	Significant wave height (m)
0	<4	<0.2
1	5-7	0.6
2	7-11	0.9
3	12-16	1.2
4	17-19	2.0
5	20-25	3.0
6	26-33	4.0

Significant wave height: an average of top N/3 higher waves when the number of waves detected within a constant time duration is N

For example, in the case of a standard marine buoy, RCS of X band radar is 5 m² as shown in the Table “Relation between Type and Height of Target and Detection Range and RCS” on Page 7-4. When observing such a target in the sea state (SS3) in which significant wave height exceeds 1.2 meters, detection probability is M-NV, as shown in the Table on page 7-5, which indicates 50 % or less.

7.3.2 Rain and snow clutter

Rain and snow clutter is a video image that appears in a location where rain or snow is falling. The image changes according to the amount of rain (or the amount of snowfall). As precipitation increases, the image of rain and snow clutter becomes intensified on the radar display, and in the case of localized heavy rain, an image similar to the image indicating land is displayed in some cases. Furthermore, because radio waves tend to attenuate due to rain and snow, the ability to detect a target in the rain and snow clutter or a target beyond the rain and snow clutter may decrease. The amount of attenuation depends on the transmission frequency, antenna beam width, and the pulse length. The following 2 graphs show examples in which detection range is reduced due to the influence of precipitation. Because of this, a target, which clearly appeared up to 10 NM by an X band radar (pulse length of 0.8 μs) when it was not raining, may become dimly visible up to 5 NM when the amount of rain becomes 4 mm/hr. Furthermore, when comparing the X band radar with the S band radar, target detection range decreases less when an S band radar is used, which means it is influenced less by precipitation.

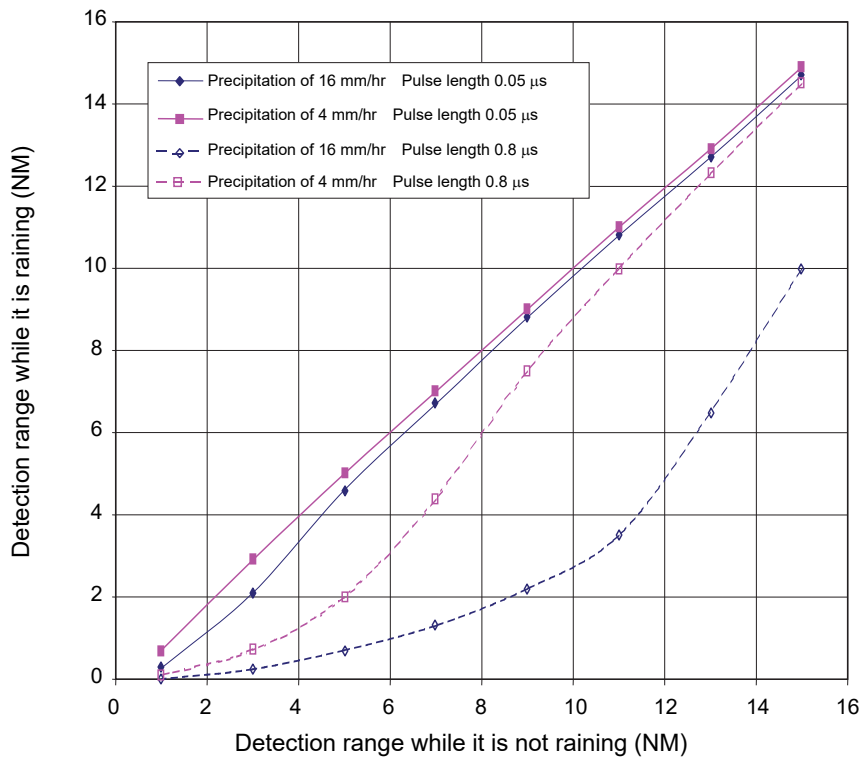

Decreased Target Detection Range by S Band Radar due to Precipitation

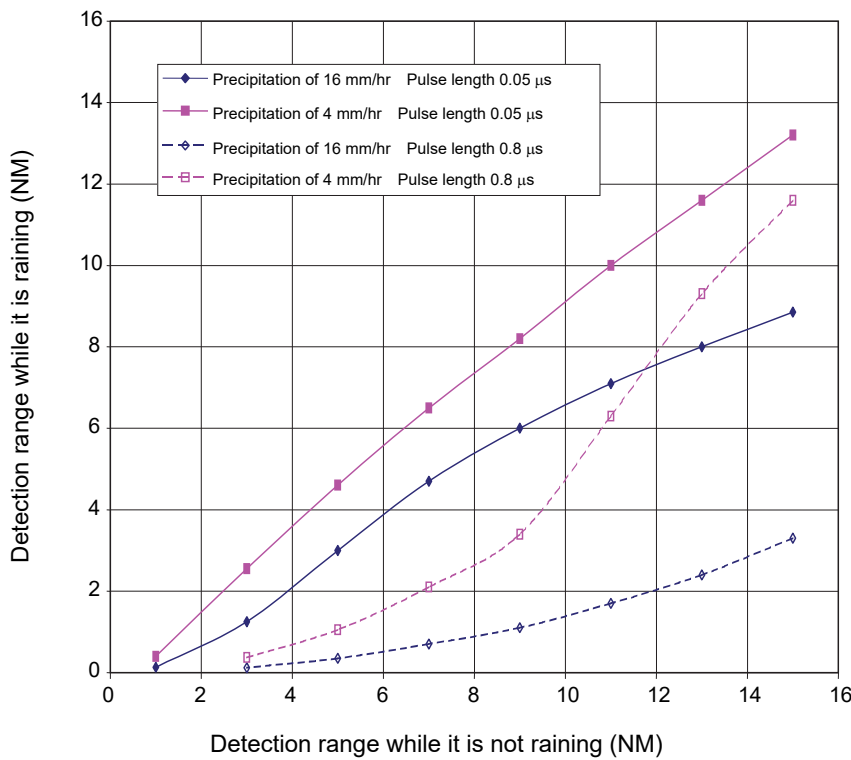

Decreased Target Detection Range by X Band Radar due to Precipitation

Note

Under rain, the targets that enter within sea clutter may be more difficult to detect.

7.3.3 Coping with sea clutter and rain/snow clutter

When the weather is bad and the ocean is rough, the use of an S band radar is effective because the radar is not influenced by sea clutter so much and attenuation due to rain drops is small. When an X band radar is used, reducing the pulse length will reduce the influence by undesired signal, and also the undesired signal rejection function effectively works; therefore, the use of short pulse is effective when the weather is bad. The effect of undesired signal control can be enhanced further by setting the various items on the [RADAR process] dialog box that is displayed by clicking the RADAR signal processing setting button.

By using the observation scene selection function that is described above, a suitable setting value can be retrieved according to various conditions such as weather (in the case of storm it is recommended to set a value for Storm or Rain).

For the description of the observation scene button, refer to "5.3.7 Adjusting to optimal images (Selection of observation scenes)". While these settings are effective, targets, particularly, those that move at high speed may not be recognized visually.

7.4 False Echoes

The radar observer may be embarrassed with some echoes that do not exist actually. These false echoes appear by the following causes that are well known:

7.4.1 Shadow

When the radar antenna is installed near a funnel or mast, the echo of a target that exists in the direction of the funnel or mast cannot appear on the radar display because the radar beam is reflected on the funnel or mast. Whether there are some false echoes due to shadows can be checked monitoring the sea clutter, in which there may be a part of weak or no returns. Such shadows appear always in the same directions, which the operator should have in mind in radar operation.

7.4.2 Side lobe effect

A broken-line circular arc may appear at the same range as the main lobe of the radar beam on the radar display. This type of false echo can easily be discriminated when a target echo appears isolated.

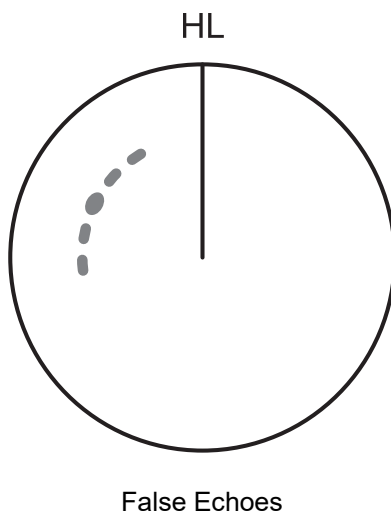

When a radar antenna for the solid-state radar is connected, a false echo may occur in the range direction of the target image. This false echo normally means a range side lobe, which is generated as a result of pulse compression processing when a large target such as a vessel is at a short distance.

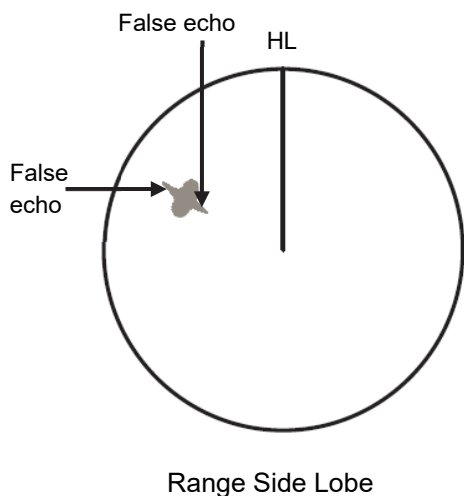

7.4.3 False echo by secondary reflection

When a target exists near own ship, two echoes from the single target may appear on the radar display.

One of those echoes is the direct echo from the target and the other is the secondary reflection from a mast or funnel that stands in the same direction as shown in the following Figure.

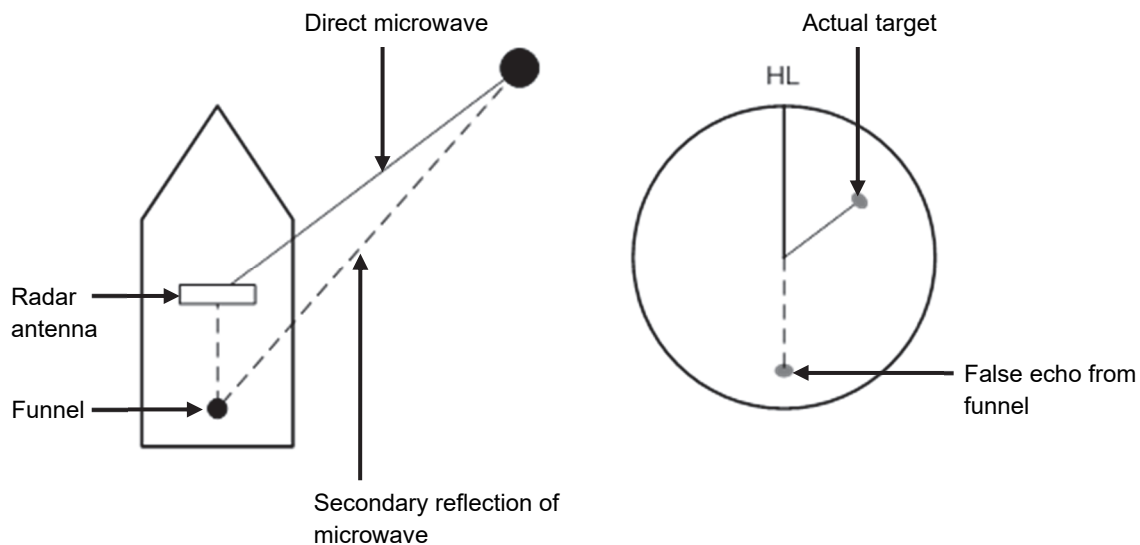

Example of false echo by secondary reflection

7.4.4 False echo by multiple reflection

When there is a large structure or ship with a high vertical surface near own ship as shown in the following Figure, multiple reflection may appear on the radar display. These echoes appear in the same intervals, of which the nearest echo is the true echo of the target.

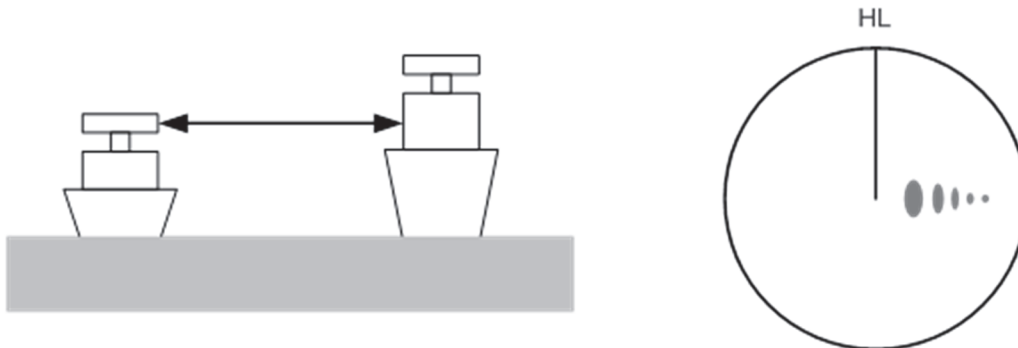

False Eco by Multiple Reflection

7.4.5 Second time echoes

The maximum radar detection range depends upon the height of the radar antenna and the height of a target as described in the section "7.1 Radar Wave with the Horizon". If a so-called "duct" occurs on the sea surface due to a certain weather condition, however, the radar beam may propagate to an abnormally long distance, at which a target may be detected by the radar.

For instance, assuming that the transmitter pulse length is MP3 (on the repetition frequency of 1400 Hz), the primary pulse is reflected about 58 NM or more away from a target and received during the next pulse repetition time. In this case, a target image appears as a false echo (second time echo) at a position that is about 58 NM less than the actual range on the radar screen.

If the false echo appears at 5 NM on the radar display, the true range of the target is $5 + 58 = 63$ NM. On the transmitter pulse length is SP1 (on the repetition frequency of 2250 Hz), a false echo may appear at a position that is about 36 NM less than the actual range.

This type of false echo can be discriminated by checking the change of the target range by switching the transmitted pulse length (the repetition frequency).

False echoes can be suppressed by setting [Economy] to [TXRX] - [TXRX] - [PRF] on the Settings menu or setting ON in [TXRX] - [TXRX] - [Stagger Trigger]. (For the details, refer to "18.6 Setting up Radar Antennas".)

7.4.6 Radar interference

When another radar equipment using the same frequency band is near own ship, a radar interference pattern may appear on the radar display. This interference pattern consists of a number of spots which appear in various forms. In many cases, these spots do not always appear at the same places, so that they can be discriminated from the target echoes.

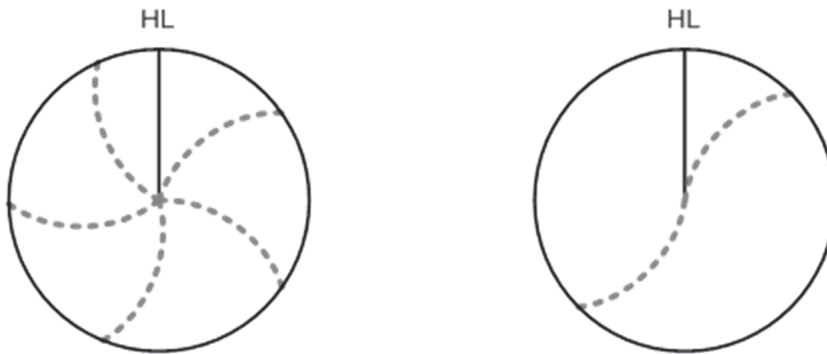

If radar equipment causing an interference pattern and this equipment are of the same model, their transmitting repetition frequency is nearly the same. As a result, interference patterns may be displayed concentrically.

In this case, since the interference patterns cannot be rejected by using only the interference rejection function, fine-tune the transmitting repetition frequency. (Refer to "18.6 Setting up Radar Antennas")

By applying different transmitting repetition frequencies, the interference rejection effect can be improved.

7.5 Radar Transponder (SART) Screen Display

SART is life-saving equipment that was approved by GMDSS and is used for detecting positions of survivors who suffer from distress accidents. SART, which operates under the frequency band of 9GHz, receives a radar wave of 9GHz that is launched from the radar of the rescue boat or plane and generates a series of response signals to notify the accident position to the searchers.

Set the equipment to the following in order to receive SART signals. Use the settings for SART reception for detecting beacons and target enhancers also.

- 1 Set the range scale to [6 NM] or [12 NM] by using the Range Scale button on the RADAR screen.**
- 2 Set to ON the settings of [Echo]-[Signal Process]-[SART] in the Settings menu (Select the check box.).**

Note

The SART setting check boxes are not displayed at connection of a 3GHz solid-state radar antenna.

The SART display mode is set to ON. In this case, the following items in the Settings menu are automatically changed to the values as indicated in the table below.

For the settings of SART, refer to “18.3 Setting Radar Signal Processing”

Setting item	Setting value
Sea (Sea clutter control)	In MAN (manual) mode, the value is changed to 0 (minimum value) and in AUTO (automatic) mode, the mode is changed to MAN and the value is changed to 0 (minimum value).
Rain (rain/snow clutter control)	
Manual Tune (Tuning)	Off (Set tuning to Off to weaken clutter display) excluding solid state radar antenna
IR (Interference removal)	Off
Echo Process (Image processing)	Process Off

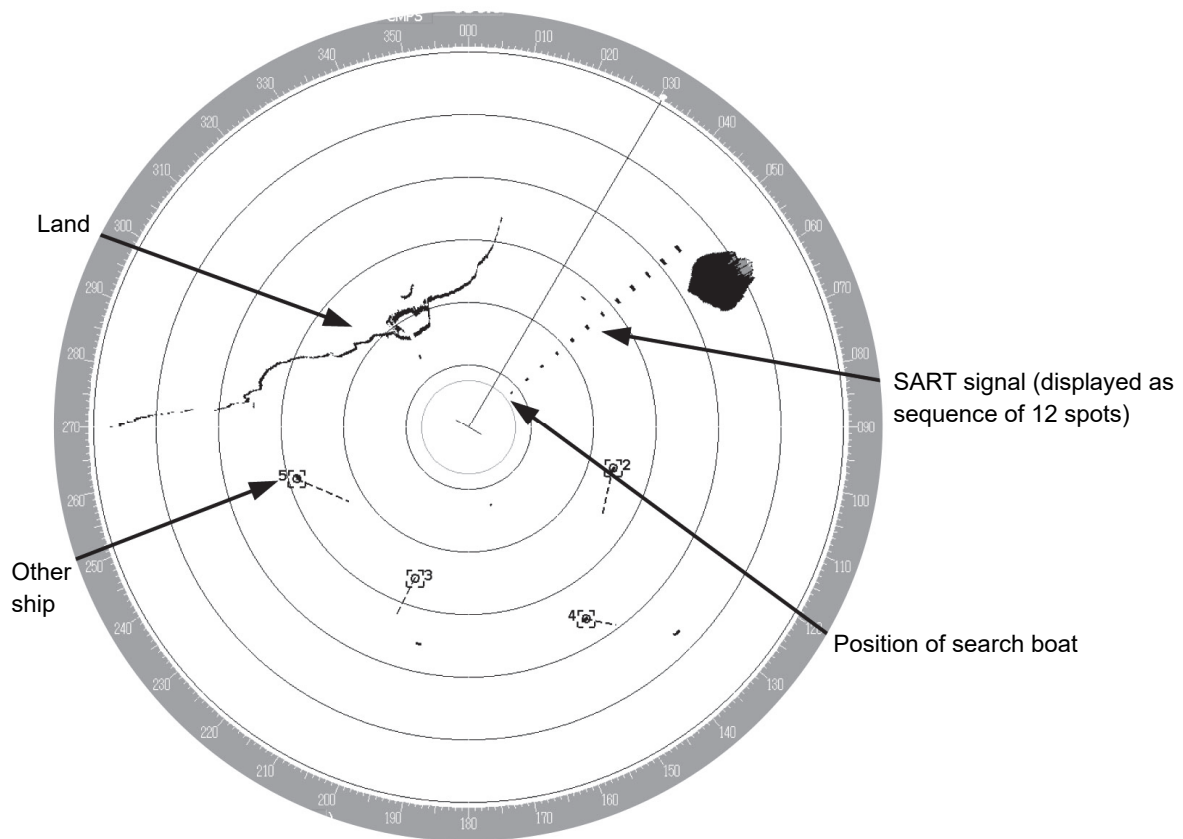

Note

- When the SART display mode is set to ON to detect SART signals, small targets around own ship may no longer be displayed on the radar screen. Therefore, implement sufficient monitoring for the periphery of own ship to prevent collision and grounding. When multiple radars are installed, use one 9GHz-band radar for detection of SART signals and use other radars as normal radars for collision prevention, monitoring of targets in periphery of own ship, prevention of grounding, and checking of own ship's position.
- After termination of SART signal detection, set the SART display mode to OFF (Uncheck the check boxes of [Echo]-[Signal Process]-[SART] in the Settings menu). The radar is reset to the normal navigation mode.

7.6 Display of AIS-SART

AIS-SART is a device to display data relating to the position of the ship in distress on the AIS display unit of the ship station and coast radio station which install the AIS. This device can be applied instead of Radar Transponder (SART). When connecting this device with the AIS, AIS-SART symbols can be also displayed on the radar screen.

7.6.1 Radar screen display example

If receiving AIS-SART signals from its device, an AIS-SART symbol is displayed on the radar screen.

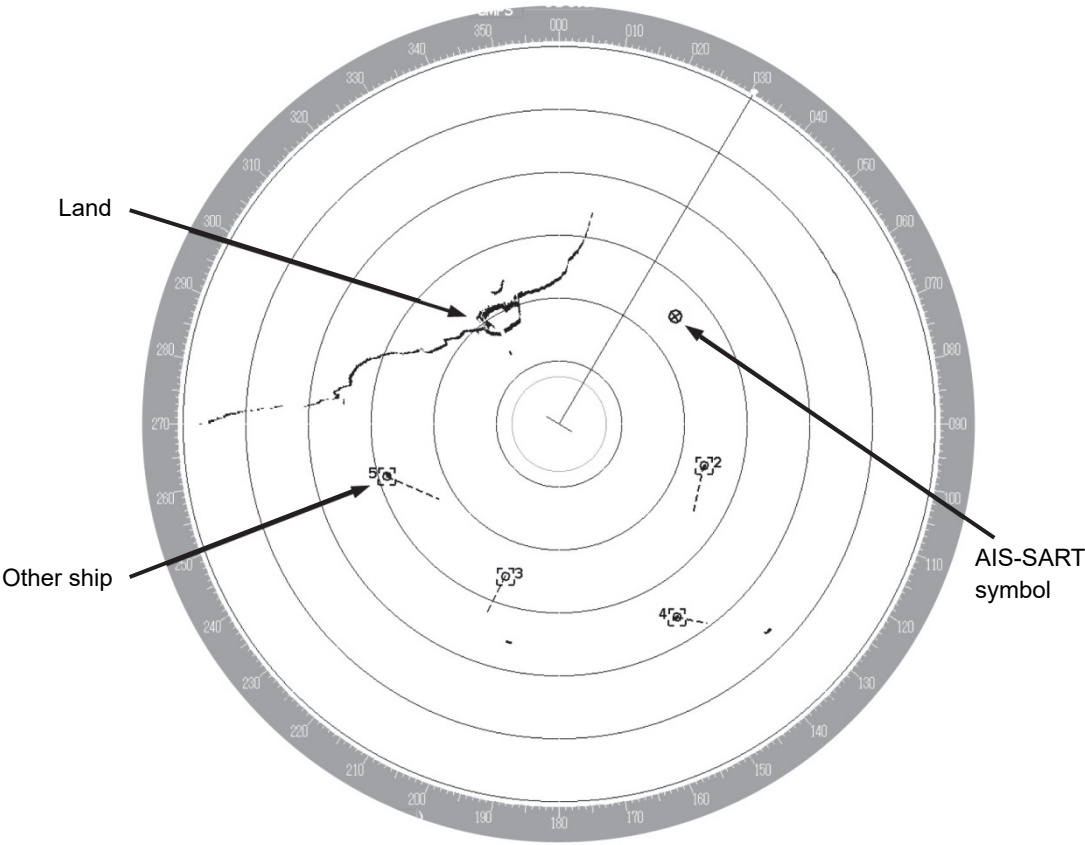

Example of AIS-SART Symbol Display

*For the details of AIS-SART symbols, refer to "6.3.3 Types and Definitions of AIS Target Symbols".

7.6.2 Numeric data display example

When the AIS-SART symbol is clicked on while it is displayed, AIS-SART numeric data is displayed in the Target Info on the information monitoring window.

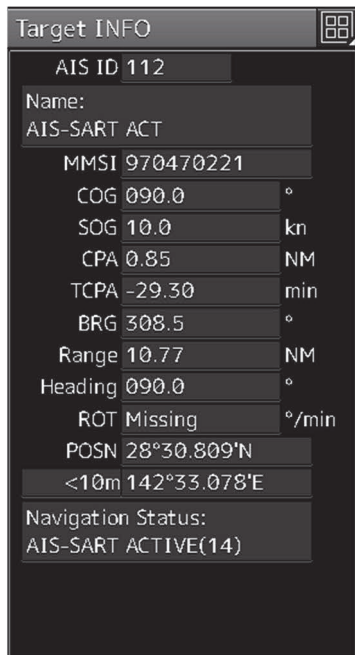

Example of AIS-SART Numeric Data Display

The following are displayed in Navigation Status area according to operating conditions:

- Normal operation: AIS-SART ACTIVE (14)
- Trial operation: AIS-SART TEST (15)

If displaying "AIS-SART TEST (15)", it indicates that the AIS-SART operation test is performing.

Section 8 Functions of the ECDIS (Option)

8.1 General Flowchart

A general flowchart of sailing using the ECDIS is shown.

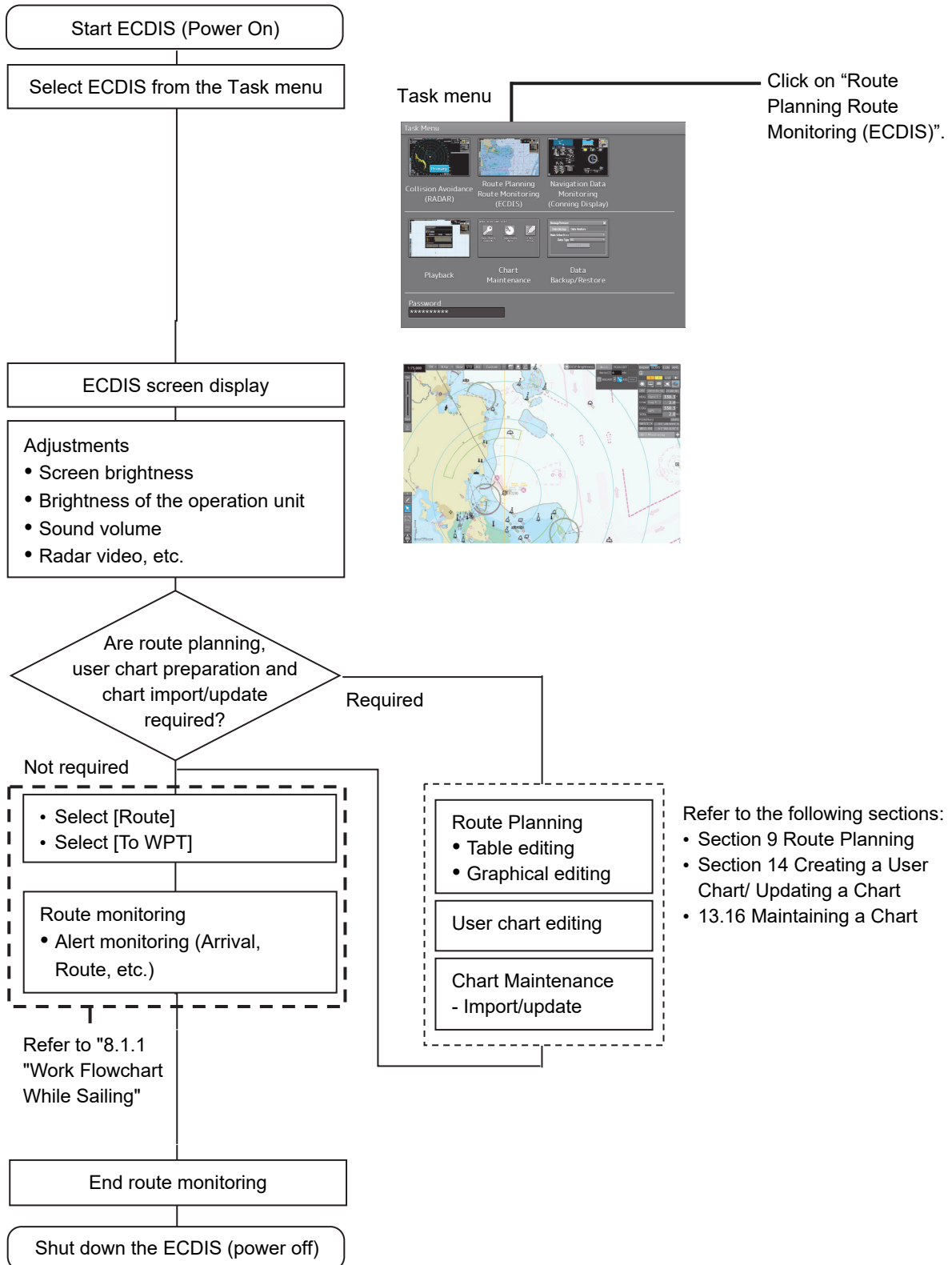

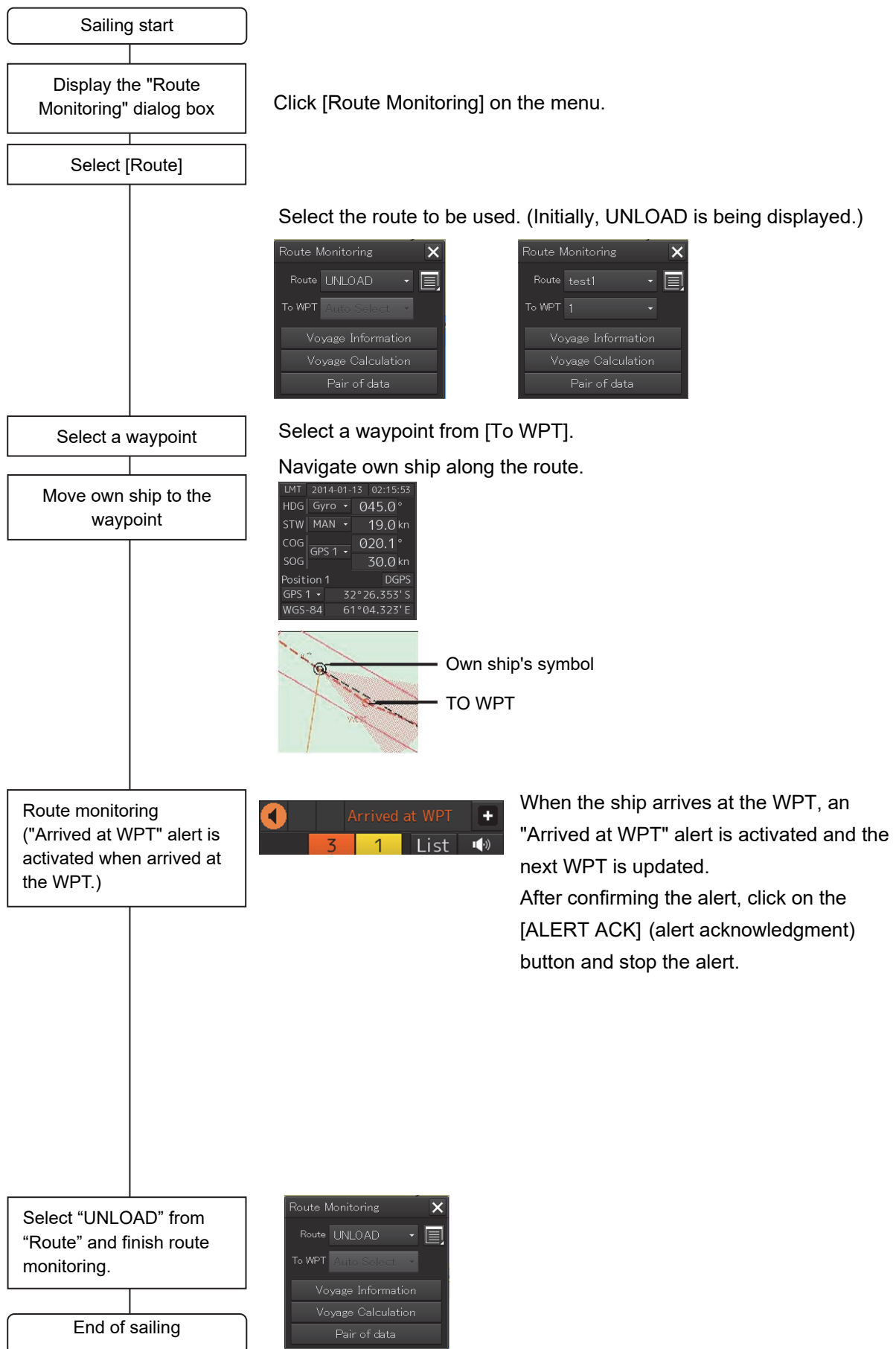

8.1.1 Work Flowchart While Sailing



8.2 Starting and Preparing the ECDIS

8.2.1 Powering on and starting

The ECDIS is powered on according to the following procedure.

 CAUTION	
	Do not leave a disk in the DVD drive. This may result in a drive problem.
	In the case of turning on the power under the condition of low temperature, do pre-heat more than 30 minutes. The equipment may not be operated normally. And accidents may result.

1 Press the Power ON button on the operation unit.

The Power button illuminates. After a while, the Task menu is displayed.

8.2.2 Starting the ECDIS

8.2.2.1 Starting the ECDIS from the Task Menu

When the ECDIS is started, the Task menu appears on the screen.

Start the ECDIS from the Task Menu.



- 1 Click on the [Route Planning Route Monitoring (ECDIS)] button on the Task menu.



The ECDIS screen is displayed.

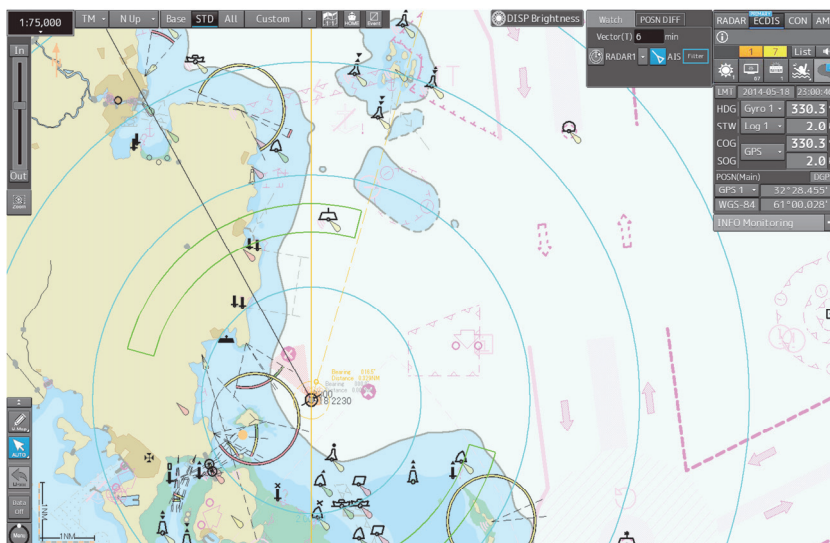

8.2.2.2 Starting ECDIS from a non-ECDIS task screen

Click on [ECDIS], a task switching button at the top right corner of the screen.

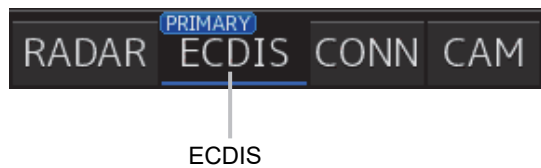

The task is switched to ECDIS.

8.2.3 Entering an ARCS PIN Number (ARCS Only)

When ARCS charts have been imported, the ARCS PIN code input dialog box appears when the ECDIS is started.

Since ARCS is restricted by the ARCS PIN number, ARCS is not displayed unless the correct ARCS PIN number is input.

To use ARCS charts, be sure to perform the following operation.

1 Input a PIN number in [ARCS PIN] of the [ARCS PIN] dialog box

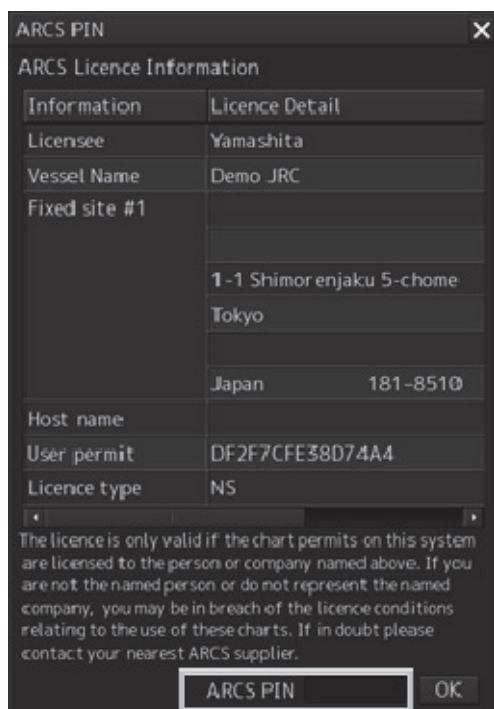

2 Click on the [OK] button.

When the [X] button is clicked on, ECDIS starts without displaying ARCS.

Note

ARCS is not displayed when the contract has expired even if the correct ARCS PIN number is input.

Memo

It is necessary to enter an ARCS PIN code only when the ECDIS screen will be displayed for the first time.

8.3 Moving the Chart

Charts can be moved by the following methods.

- Moving by the [Home] button
- Moving by the cross-hair cursor
- Moving by the hand cursor
- Switching display from the [My Port List] dialog box
- Displaying by entering a position

8.3.1 Moving the chart with the [HOME] button

Display can be moved to a position where the heading direction of own ship can be observed in a panoramic view. Use this feature if own ship is lost from charts.

- 1 Click on the [Home] button in Chart Information Area.

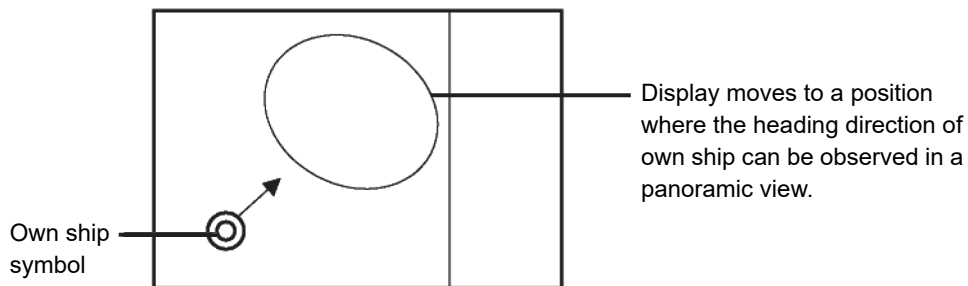

Display moves to a position where the heading direction of own ship can be observed in a panoramic view.

Screen Display of Home Position

8.3.2 Moving the chart with the cross-hair cursor

When the cross-hair cursor is moved to an arbitrary position on the chart and then clicked, the chart can be moved. The chart moving position varies with the setting of the motion mode.

For information about the motion mode, refer to "8.6 Selecting Motion/Bearing Mode".

[When the motion mode is set to true motion]

The position of the cross-hair cursor becomes the center of the screen.

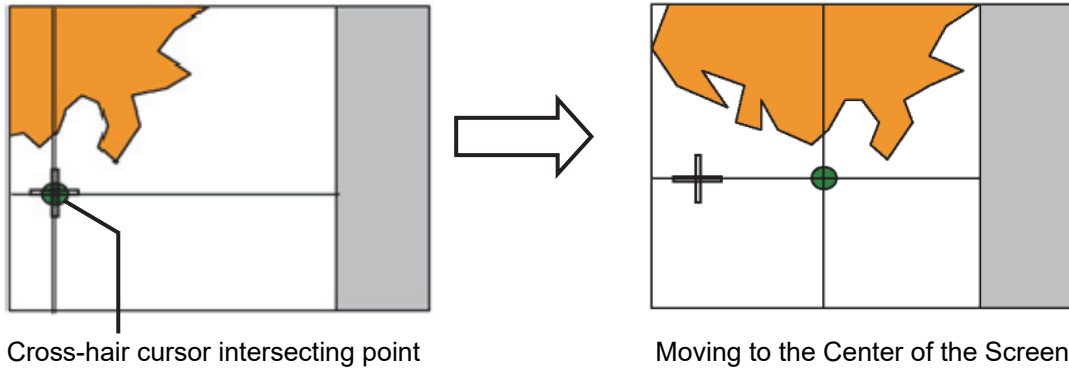

[When the motion mode is set to relative motion]

The position of the cross-hair cursor becomes own ship's display position.

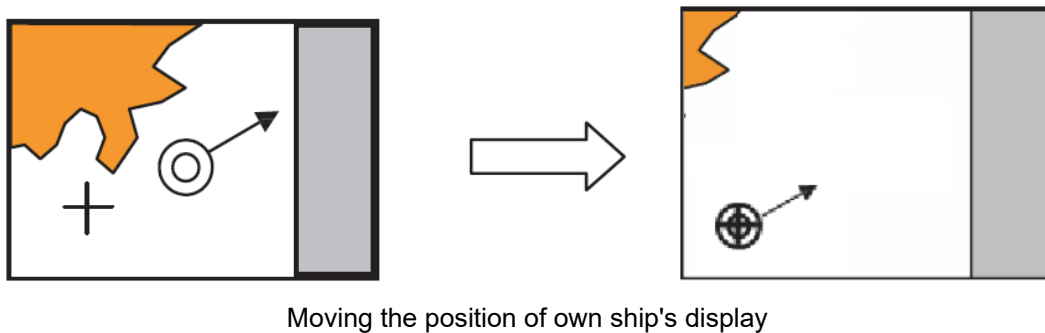

8.3.3 Moving the chart with the hand cursor

The chart can be moved by grabbing it with the hand cursor.

- 1 Move the cursor to the position where you want to grab the chart.
- 2 When the trackball is turned while the button is pressed, the cursor changes to a hand cursor and the chart moves.

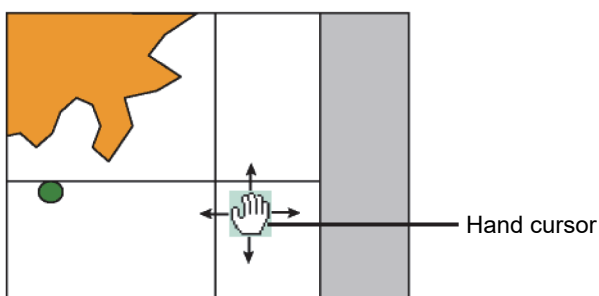

Memo

If own ship sails outside of the screen, the motion mode will automatically be set to Free (free motion).

8.3.4 Switching a chart to be displayed by [My Port List]

If port names are registered in My Port List in the [My Port List] dialog box, chart display can be switched to the one having the latitude and longitude of a registered port at the center of the chart.

1 Click on the [Menu] button on the left toolbar.

The menu is displayed.

2 Click on [Chart] - [My Port List] on the menu.

The [My Port List] dialog box appears.

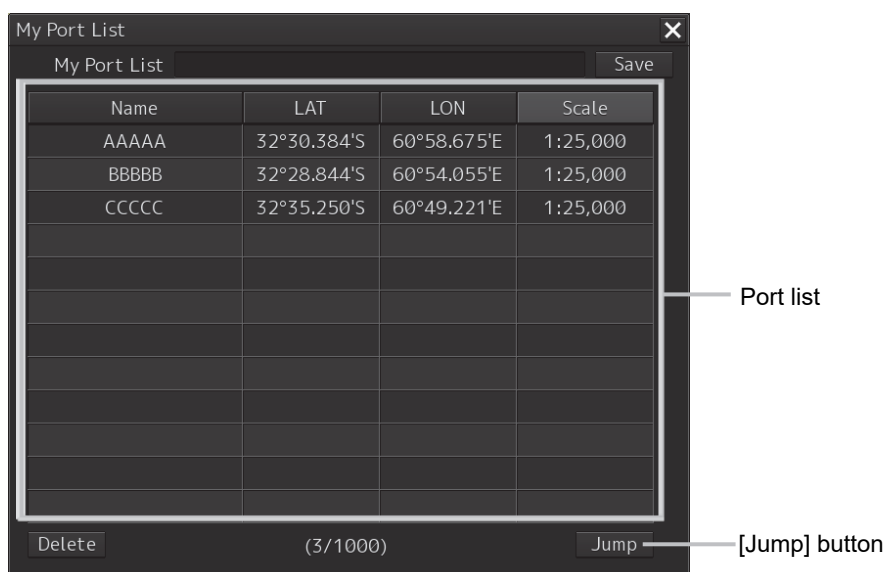

For how to register and delete ports, refer to "8.7 Registering and Displaying My Port List".

3 Click on a port in the list to select it.

4 Click on the [Jump] button.

The chart is displayed having the latitude and longitude of the selected port at the center of the chart.

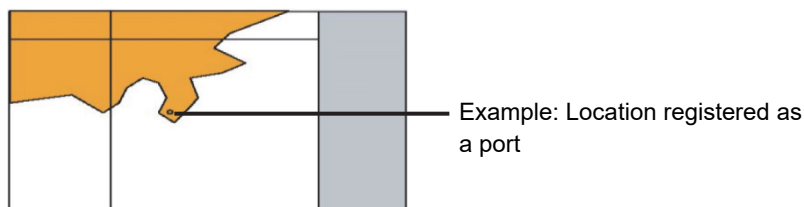

8.3.5 Displaying the chart by entering the position

By entering a position, the chart of a desired position can be displayed.

- 1 Click on the [Menu] button on the left toolbar.

The menu is displayed.

- 2 Click on [Chart] - [Off Center by Entering Position] on the menu.

The [Off Center by Entering Position] dialog box appears.

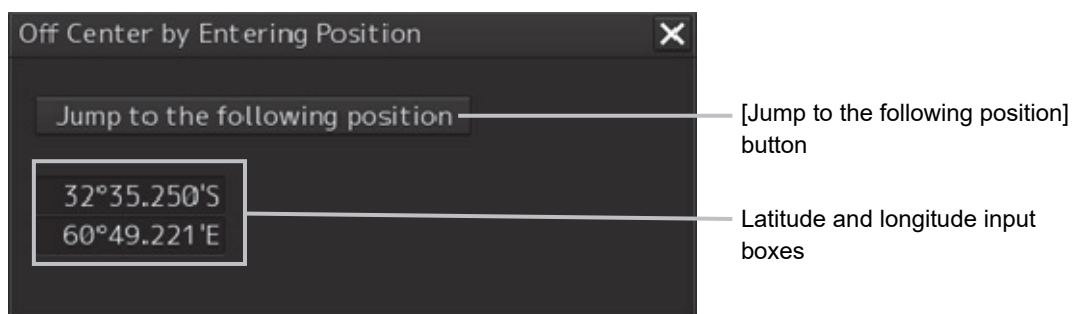

The latitude and longitude of the center of the current screen is displayed in the latitude and longitude input boxes.

- 3 Click the latitude and longitude input boxes.
- 4 Enter the latitude and longitude of the chart you want to display with the software keyboard.

Memo

The maximum latitude input range is 85 ° 00.000 (polar range restriction).

- 5 Click on the [Jump to the Following Position] button.

The chart is displayed having the entered latitude and longitude at the center of the chart.

8.4 Zooming In/Out the Chart

The chart can be enlarged and reduced by the following methods.

Item	Related sections
Enlarging a selected area	8.4.1 Enlarging a Selected Area (S-57/C-MAP Only)
Enlarging/reducing with the [ZOOM IN]/[ZOOM OUT] key on the operation unit (S-57/C-MAP only)	8.4.2.1 Enlarging/reducing with the [ZOOM IN]/[ZOOM OUT] key on the trackball operation unit
Enlarging/reducing with the zoom slider (S-57/C-MAP only)	8.4.2.2 Enlarging/reducing with the zoom slider (S-57/C-MAP only)
Enlarging/reducing with the Large/Small buttons (RNC only)	8.4.2.3 Enlarging/reducing with the [Large]/[Small] buttons (RNC only)

8.4.1 Enlarging a Selected Area (S-57/C-MAP Only)

A selected area can be enlarged to the full chart screen size.

- 1 Click on the [Zoom Area] button.

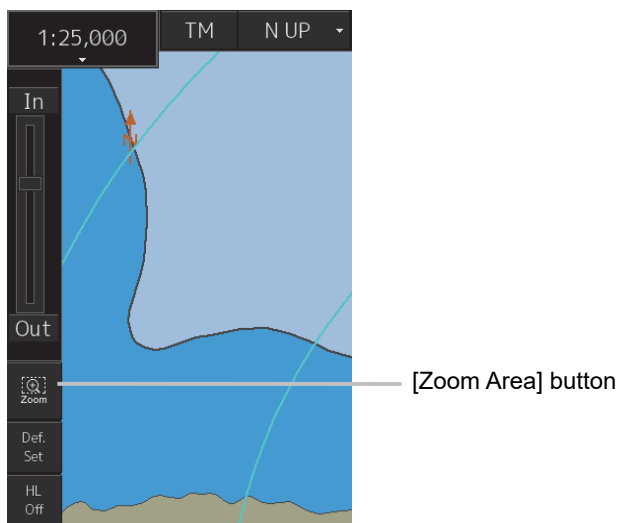

The cross-hair cursor changes to a zoom cursor.



-
- 2** Using the trackball, move the cursor to "A" located at the upper left of the range you want to enlarge, and then click.
 - 3** Using the trackball, move the cursor to "B" located at the lower right of the range you want to enlarge, and then click.

The enlarging range is enclosed with a rubber band and then that range is enlarged to the full screen size.

Once enlarged, the zoom cursor changes back to the cross-hair cursor.

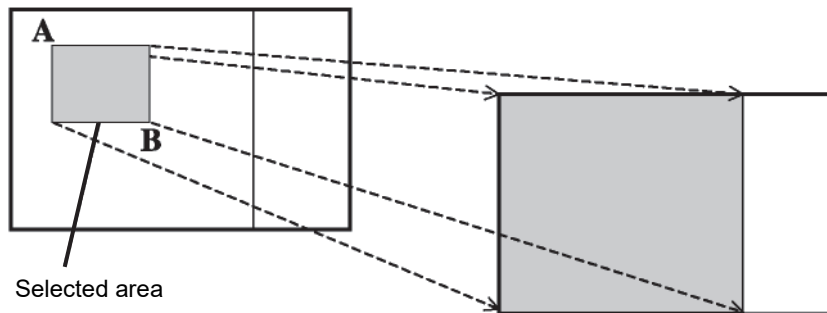

Memo

Switching charts

- Generally, multiple charts with different scales are provided for the same area; charts having matching scale values are selected/displayed by enlargement or reduction.
- When a displayable scale range is assigned to an original scale of a chart and the original scale is beyond this range, the chart will not be displayed unless there are other displayable charts.
- This equipment is installed with a world map background chart as the reference chart and the chart is always displayed in the background.

8.4.2 Enlarging/reducing a chart with the Zoom function

8.4.2.1 Enlarging/reducing with the [ZOOM IN]/[ZOOM OUT] key on the trackball operation unit (S-57/C-MAP only)

- 1 Each time the [ZOOM IN] key is pressed, the chart is enlarged according to the range or scale that has been set up.
Each time the [ZOOM OUT] key is pressed, the chart is reduced according to the range or scale that has been set up.

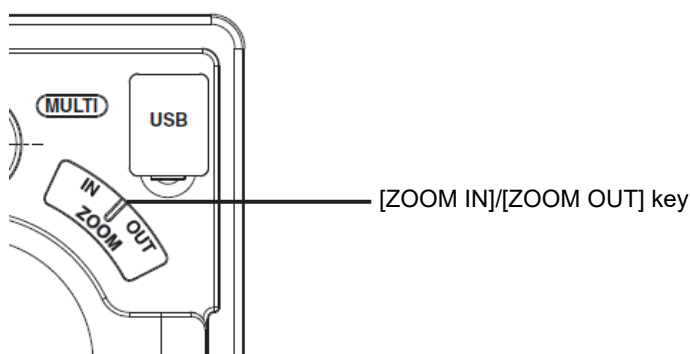

For the details of switching between range and scale, refer to "8.4.3 Switching between scale and range (S-57/C-MAP only)".

8.4.2.2 Enlarging/reducing with the zoom slider (S-57/C-MAP only)

- 1 When the slider handle is clicked upward, display is enlarged. When it is clicked downward, display is reduced.
Each time the [In] (zoom in) button is clicked on, the chart is enlarged according to the range or scale that has been set up.
Each time the [Out] (zoom out) button is clicked on, the chart is reduced according to the range or scale that has been set up.

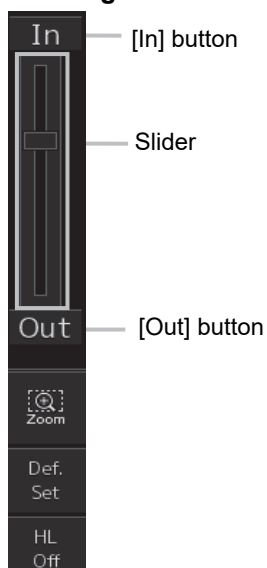

For more information about switching between range and scale, refer to "8.4.3 Switching between scale and range (S-57/C-MAP only)".

Memo

Over Scale permanentIndication

When the ship enters a different chart, an over-scale activated if the displayed chart is more than double in size than the original data. The vertical lines as seen in the figure below will be displayed on the "chart" to notify lower chart accuracy and clarity. The vertical lines will not be displayed if the size has been made larger (double or more) through proper operation.

An "Over Scale" permanentIndication is displayed in the alert display area.

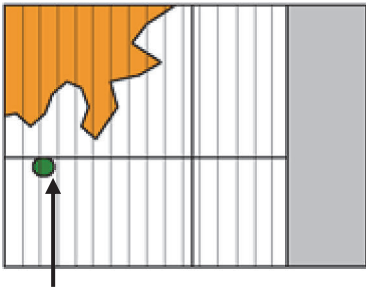

Notification line at Over Scale

Case in which an Over Scale permanentIndication is not displayed (1)

When a single cell is displayed in full screen with the scale exceeding double the compilation scale, the Over Scale warning line is not displayed. However, an "Over Scale" permanentIndication is displayed.

Compilation Scale
 GB4X0000=1/52,000、M_CSCL=1/45,000
 GB5Xnnnn=1/25,000

When the display area comprises a single compilation scale, AP (OVSC01) drawing is not performed.

GB4X0000

M_CSCL

(A)

GB5X01NW	GB5X01NE
GB5X01SW	GB5X01SE
	GB5X02SE

(B)

Display example of the display area (within the screen frame)

(A)
Display scale 1/10,000

(B)
Display scale 1/10,000

Case in which an Over Scale permanentIndication is not displayed (2)

When multiple cells exist within the screen frame in the scale exceeding double the compilation scale, an Over Scale warning line is not displayed in cells other than the cell of the minimum scale.

Warning display is performed and an "Over Scale" permanentIndication is displayed.

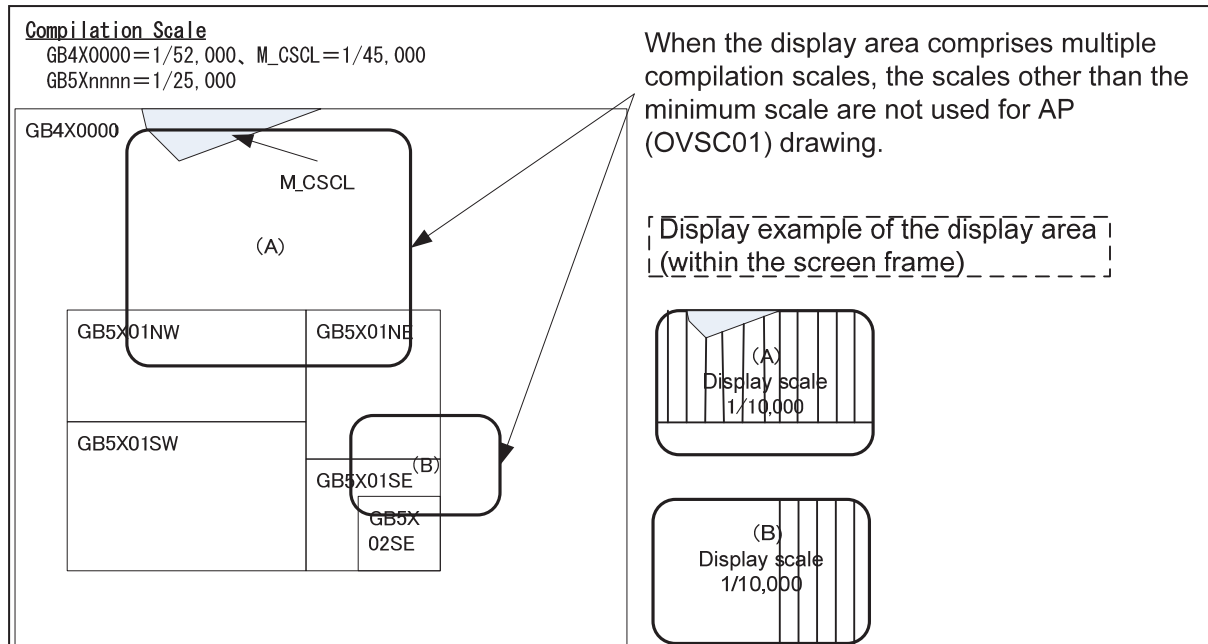

8.4.2.3 Enlarging/reducing with the [Large]/[Small] buttons (RNC only)

- 1 Each time the [Large] button is clicked on, the chart is enlarged by one scale level (larger scale charts).

Each time the [Small] button is clicked on, the chart is reduced by one scale level (smaller scale charts).

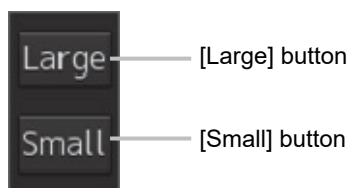

8.4.3 Switching between scale and range (S-57/C-MAP only)

The current scale or range is displayed on the Scale/Range button in Chart Information Area.



The settings of scale and range as well as their switching method are as follows.

1 Click on the Scale/Range button.

The scale and range settings menu appears.

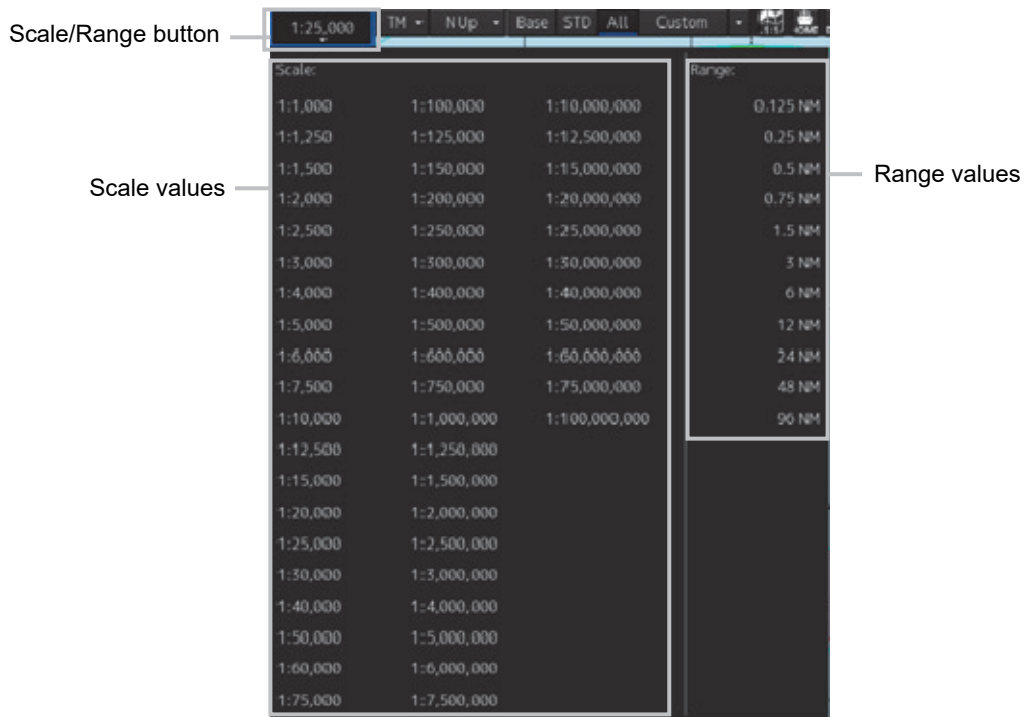

2 Select a scale or range value from the menu.

The chart is displayed having the selected scale or range.

Memo

For range display, the half of the screen width becomes the specified range when displayed.

For a multi screen (refer to “8.10 Multi View Display and Wide Range View Window Display of Charts”), the half the display screen View1/View2 becomes the specified range when displayed.

8.5 Changing the Object Category (S-57/C-MAP Only)

SENC (System Electronic Navigation Chart) information available for display in the chart is subdivided into three object groups; Base (Base display), STD (Standard Display), and All (All display). You can change the object category using the display panel.

Base (Base Display)

A group of important objects that cannot be deleted from the charts (coastline and safety contour lines)

STD (Standard: Standard display)

A group of objects less important than base display (fixed and floating objects for monitoring)

All (All display)

All objects

Custom (Custom)

Refer to "8.5.2 Customizing object display"

Memo

About display in the chart

Display in the chart can be considered as the composite of various layers. For example, STD (Standard: Standard display) is the composite of object layers for Base (Base display) and object layers for STD (Standard: Standard display).

In addition to the object layers of the S-57/C-MAP charts themselves, own ship, user charts, event marks, EBL/VRM, radar images, etc. can be combined and then displayed.

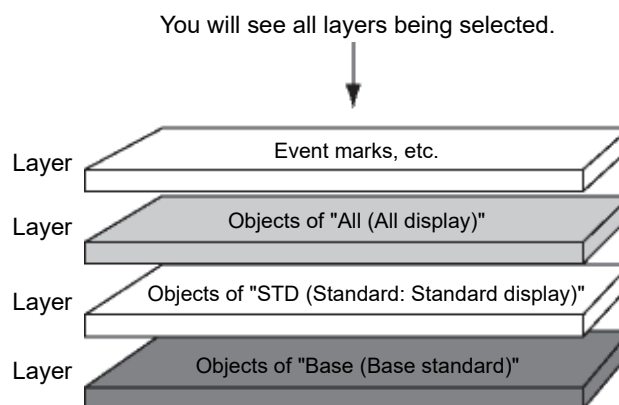

Note

The initial chart screen status is "STD (Standard: Standard display)". For safe sailing, use the "STD (Standard: Standard display)" or "All (All display)", not the "Base (Base display)".

8.5.1 Switching object display

- 1 Click on one of the buttons of the Chart Information Area display category.

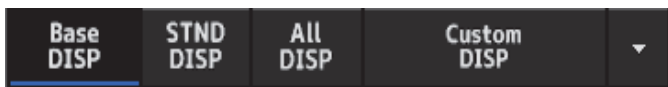

Information displayed on the chart changes.

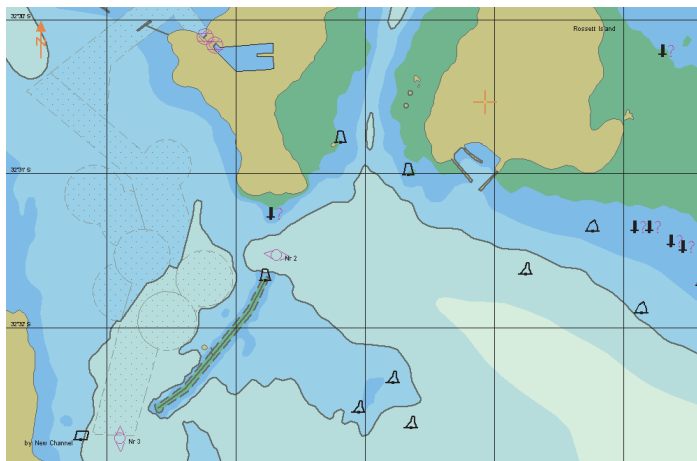

"Base (Base display)" Example

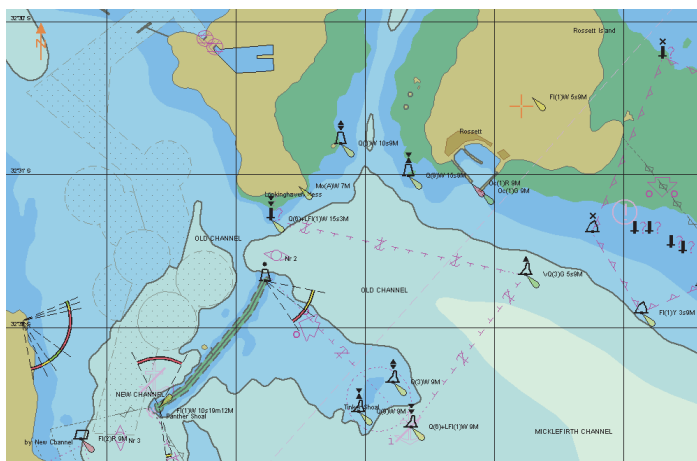

"STD (Standard: Standard display)" Example

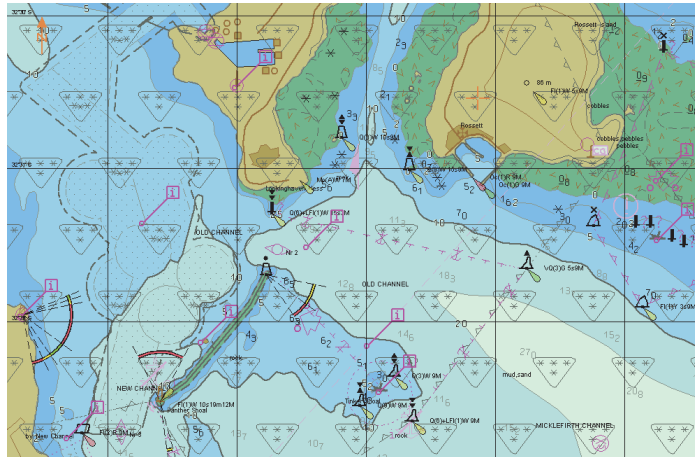

"All (All display)" Example

Note

The display will be in gray without displaying a chart when a corresponding chart does not exist in the display area, when a chart exists with only a part of data, or when the display scale does not match the chart scale. In this case, change the scale to check if a chart can be displayed.

8.5.2 Customizing object display

When the [Custom] button of the Chart Information Area is clicked on, the object corresponding to the setting in the [Chart Display] dialog is displayed. Any of the objects that are displayed on the [Chart Display] dialog can be set.

- 1 Click on the [Custom] menu display button.



The display changes as follows.

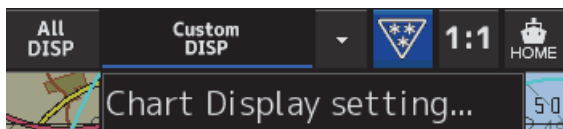

2 Click on the [Chart display setting] button.

[Chart Display] dialog is displayed.

The edit pane is divided into three dialogs.

To advance to the next dialog: Click on the [Next] button.

To return to the previous dialog: Click on the [Back] button.

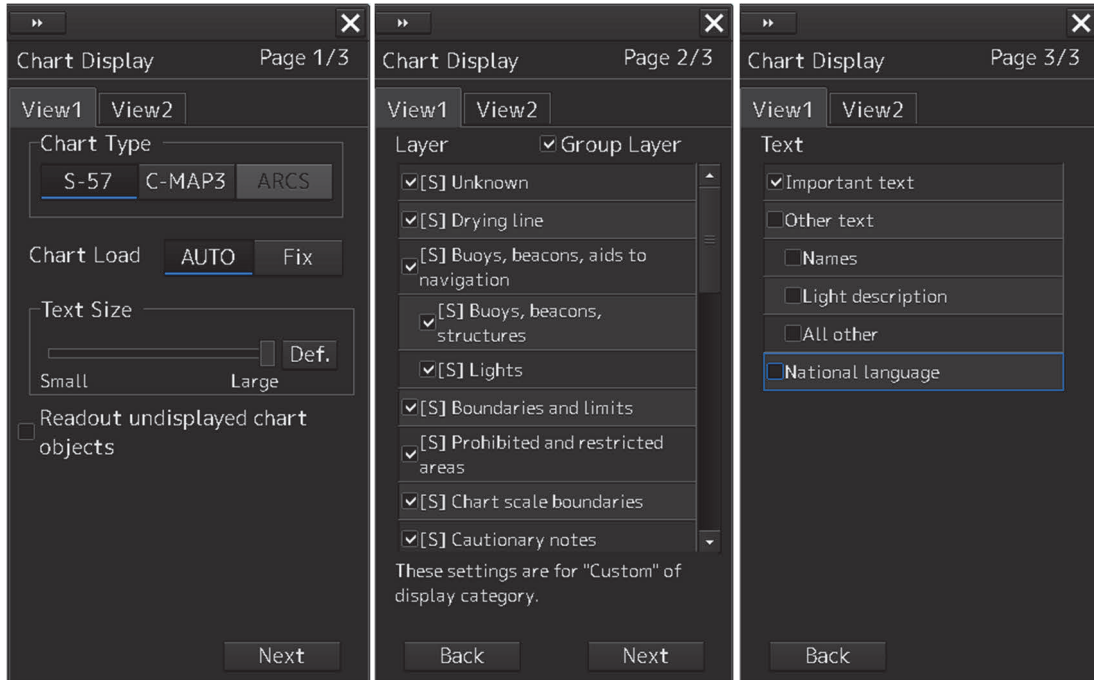

3 Set the object to be displayed.

For the setting of the [Chart Display] dialog, refer to "16.2.11 Setting up the Display of ECDIS Chart".

Memo

The [Chart Display] dialog can also be displayed by selecting [View] - [Options] - [Chart Display] on the menu.

8.6 Selecting Motion/Bearing Mode

Using the Motion/Bearing Mode combo box in Chart Information Area, set up the motion mode and the bearing mode on own ship's chart. The mode that can be selected varies with the chart type.

S-57/C-MAP Ed.3 Charts

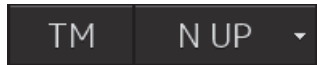

Motion mode button Bearing mode button

[Selectable combinations in the motion mode and the bearing mode]

Motion mode \ Bearing mode	Bearing mode			
	N UP	H UP	C UP	WPT UP
TM	○	×	○	×
RM	○	○	○	○
Free	○	×	○	×

ARCS Charts



Motion mode button

*The bearing of the ARCS chart is fixed to N UP.

8.6.1 Setting motion mode

Set a motion mode with the Motion Mode ~~combobox~~ button in Chart Information Area.

- 1 Display the current Motion Mode.
- 2 Change TM/RM/Free by short pressing the button to the left.

Setting item	Description	Display image
[TM]	<p>True Motion Mode</p> <ul style="list-style-type: none"> Land and other fixed objects are fixed on the display and only own ship moves on the display. When own ship reaches the predetermined limit, the chart is automatically shifted so that own ship always remains on the screen. 	<p>The diagram shows a green grid representing a chart. A vertical orange arrow labeled 'Fixed' is in the top-left corner. A black ship icon labeled 'Own ship' is in the center. A dashed line labeled 'Heading line' extends from the ship towards the top-right. The grid is shifted such that the ship remains centered.</p>
[RM]	<p>Relative Motion Mode</p> <ul style="list-style-type: none"> Own ship is fixed at the center of the screen and the fixed objects such as land move relatively. 	<p>The diagram shows a green grid. A black ship icon labeled 'Fixed on ship position' is in the center. A dashed line labeled 'Heading line' extends from the ship towards the top-right. A vertical orange arrow labeled 'Moves relatively' is in the top-left corner. The grid is centered on the ship.</p>
[Free]	<p>Free</p> <ul style="list-style-type: none"> You can freely move the chart on the display regardless of the own ship's direction. As the own ship goes, it disappears from the screen. 	<p>The diagram shows a green grid. A vertical orange arrow labeled 'Fixed' is in the top-left corner. A black ship icon labeled 'Own ship' is in the center. A dashed line labeled 'Heading line' extends from the ship towards the top-right. The grid is not shifted.</p>

Mode change by the operation:

In the following cases, the motion/bearing mode will be automatically changed from the current mode to another one.

- From [TM] mode to [Free] mode:
 - When an area outside of the own ship range was displayed by loading charts or clicking the [Jump] button in the [My Port List] dialog box.
- From [RM] mode to [Free] mode:
 - When the own ship goes exceeding the display limit of the screen by scrolling the chart.
 - When an area outside of the own ship range was displayed by loading charts or clicking the [Jump] button in the [My Port List] dialog box.
- From [Free] mode to [TM] mode:
 - When the [Home] button was clicked on,
the rotation in the Free mode is retained after changing to the TM mode.

Note

H UP, WPT UP, C UP are valid only the chart scale is not lower than 1/5,000,000.
--

8.6.2 Setting Bearing mode (S-57/C-MAP only)

Set a bearing mode with the Bearing Mode button in Chart Information Area.

- 1 Click on the Bearing Mode combo box.
- 2 Select a bearing mode.

Setting item	Description	Display image
[N UP]	<p>North up</p> <ul style="list-style-type: none"> The chart is always displayed towards true north. Fixed objects do not flicker and are easily identified on the chart, and the true bearing of the objects can readily be read out. 	
[H UP]	<p>Head up</p> <p>The chart is displayed by orienting the ship's heading upward. Cannot be selected under TM (true motion).</p>	
[C UP]	<p>Course up</p> <ul style="list-style-type: none"> At the setting of Course Up, the ship's heading (HDG) is fixed and displayed immediately above the screen. 	
[WPT UP]	<p>Way point up</p> <ul style="list-style-type: none"> The chart rotates automatically so that the screen is always oriented upward until the target WPT. 	

Setting item	Description	Display image
[C UP (Angle Setting)]	<p>Course UP by angle setting</p> <ul style="list-style-type: none"> When this item is selected, the [C UP (Angle Setting)] dialog box appears. The course angle that was set on the dialog is displayed right above the chart and fixed. <div data-bbox="483 472 935 680" data-label="Image"> </div> <ul style="list-style-type: none"> Input the angle of the ship's heading in the [Angle] input box of the [C UP (Angle Setting)] dialog box. The angle can be input (increase/decrease) by operating the angle input slider. After completing the setting, click on the [X] button. 	<div data-bbox="986 221 1353 495" data-label="Image"> </div>

Display changes according to the selected bearing mode.

8.7 Registering and Displaying My Port List

8.7.1 Registering to My Port List

You can register any position on the chart to the "My Port List" dialog box. After registration, you can directly access to that position by selecting a port name from the My Port List.

1 Set the location to be registered.

S-57/C-MAP

Since the center position and the display scale of the screen that is currently displayed are registered in the port name list, move the location to be registered to the center of the screen in advance.

To display another position, shift the chart area (refer to "8.3 Moving the Chart") or zoom in to/out from the chart. (Refer to "8.4 Zooming In/Out the Chart").

ARCS

Since the center position and the display scale of the screen that is currently displayed are registered in the port name list, move the location to be registered to the center of the screen in advance.

To display another position, display the chart according to the procedures provided below.

- 8.9.1 Selecting charts from all
- 8.9.2 Changing active panels (ARCS only)

2 Click on the [Menu] button on the left toolbar.

The menu is displayed.

3 Click [Chart] - [My Port List] on the menu.

The [My Port List] dialog box appears.

In the [My Port List] dialog, the Name, LAT (latitude), LON (longitude), and display Scale (scale) of the port that is currently registered are displayed.

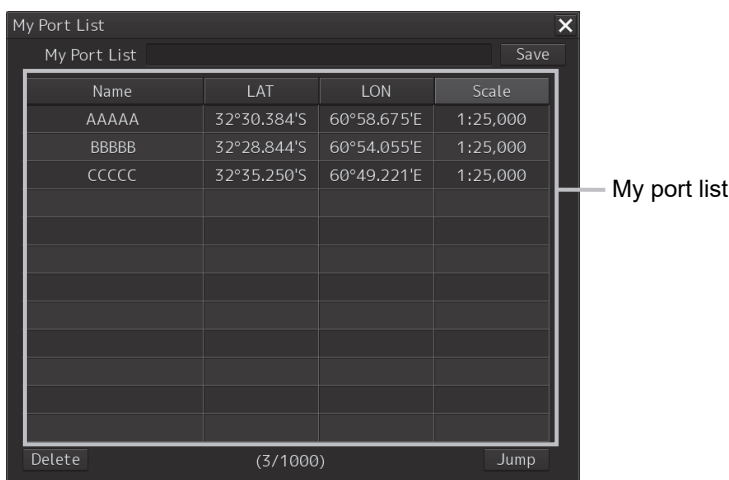

4 Enter the registration name of the port in the [My Port List] (port name) input box.

5 Click on the [Save] button.

The coordinates (latitude and longitude) of the center of the chart display and the display scale according to the registration name designated in the step 4 are registered in the list as the port.

8.7.2 Deleting a port

1 Click on the [Menu] button on the left toolbar.

The menu is displayed.

2 Click [Chart] - [My Port List] on the menu.

The [My Port List] dialog box appears.

3 Click on the port to be deleted from the My Port List.

The port is selected.

4 Click on the [Delete] button.

The selected port is deleted from the My Port List.

8.8 Selecting a S-57 chart

Because the chart of own ship's position is automatically called up after power on, generally route monitoring can be performed instantly.

If you want to display charts other than the chart automatically called up, select a chart from those that are displayed by selecting [Chart] - [Select S-57 Chart] on the menu.

For the details, refer to "13.2 Displaying/Searching an S-57 Chart [Select S-57 Chart]".

8.9 Selecting an ARCS chart

This section describes chart selection and the functions on the display, which are available on the ARCS chart.

8.9.1 Selecting charts from all

You can select desired charts from all the charts stored in this system.

- 1 Click on the [Select] button in Chart Information Area.



Chart selection button

The [Select Chart] dialog box appears.

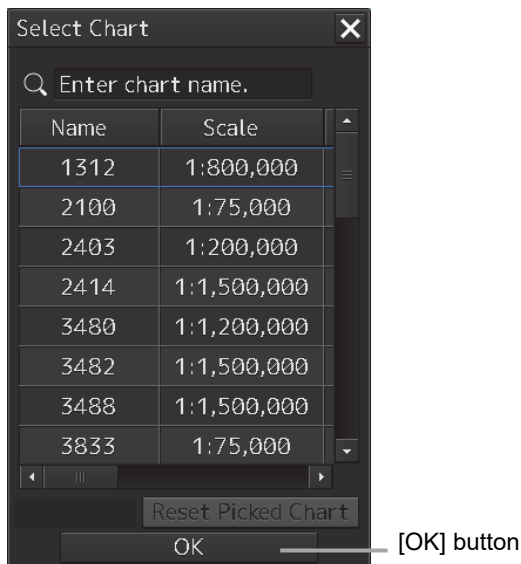

- 2 Select the desired chart in the list by clicking it and then click on the [OK] button.

The selected chart is displayed on the screen.

8.9.2 Changing active panels (ARCS only)

The active panel on the chart can be changed.

- 1 Right-click on the chart**
The context menu is displayed.
- 2 On the Context menu, click on the [Change Active Panel].**
The selectable active panel painted in blue is displayed.
- 3 Click on in the blue panel. The corresponding chart is then displayed.**

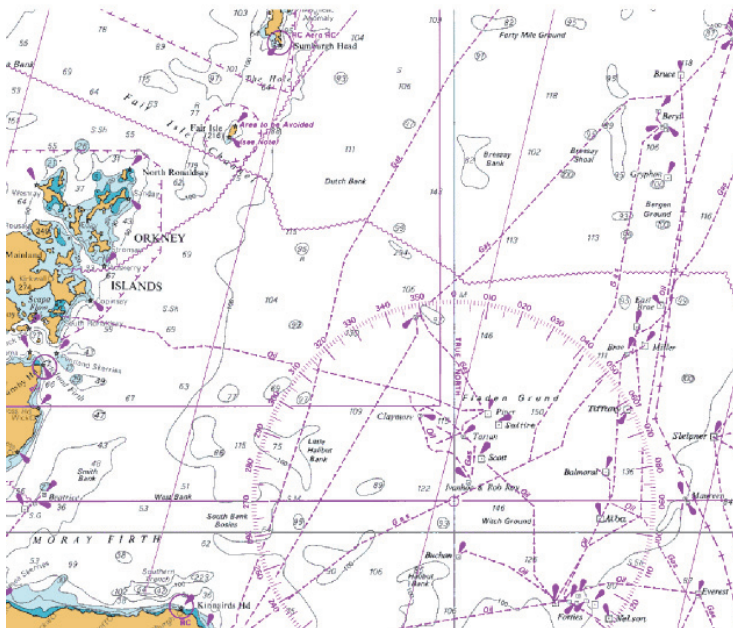
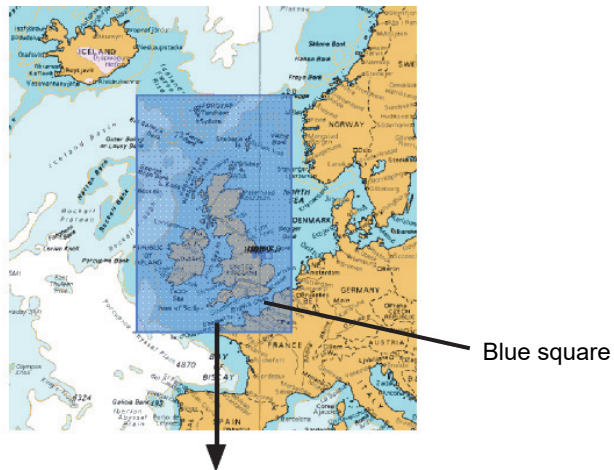

Selected chart

8.9.3 Changing a low resolution chart (ARCS only)

1 Right-click on the chart

The context menu is displayed.

2 On the Context menu, click on the [Load Low Resolution].

The low resolution chart is displayed on the screen.

8.9.4 Changing a high resolution chart (ARCS only)

- 1 Right-click on the chart**
The context menu is displayed.
- 2 On the Context menu, click on the [High Resolution Area].**
The cursor changes to the zoom cursor and an orange frame appears on the chart.
- 3 Move the cursor to the area to be expanded (the frame moves together with the cursor) and click the mouse button.**
The high-resolution chart in the area within the frame is displayed on the screen.

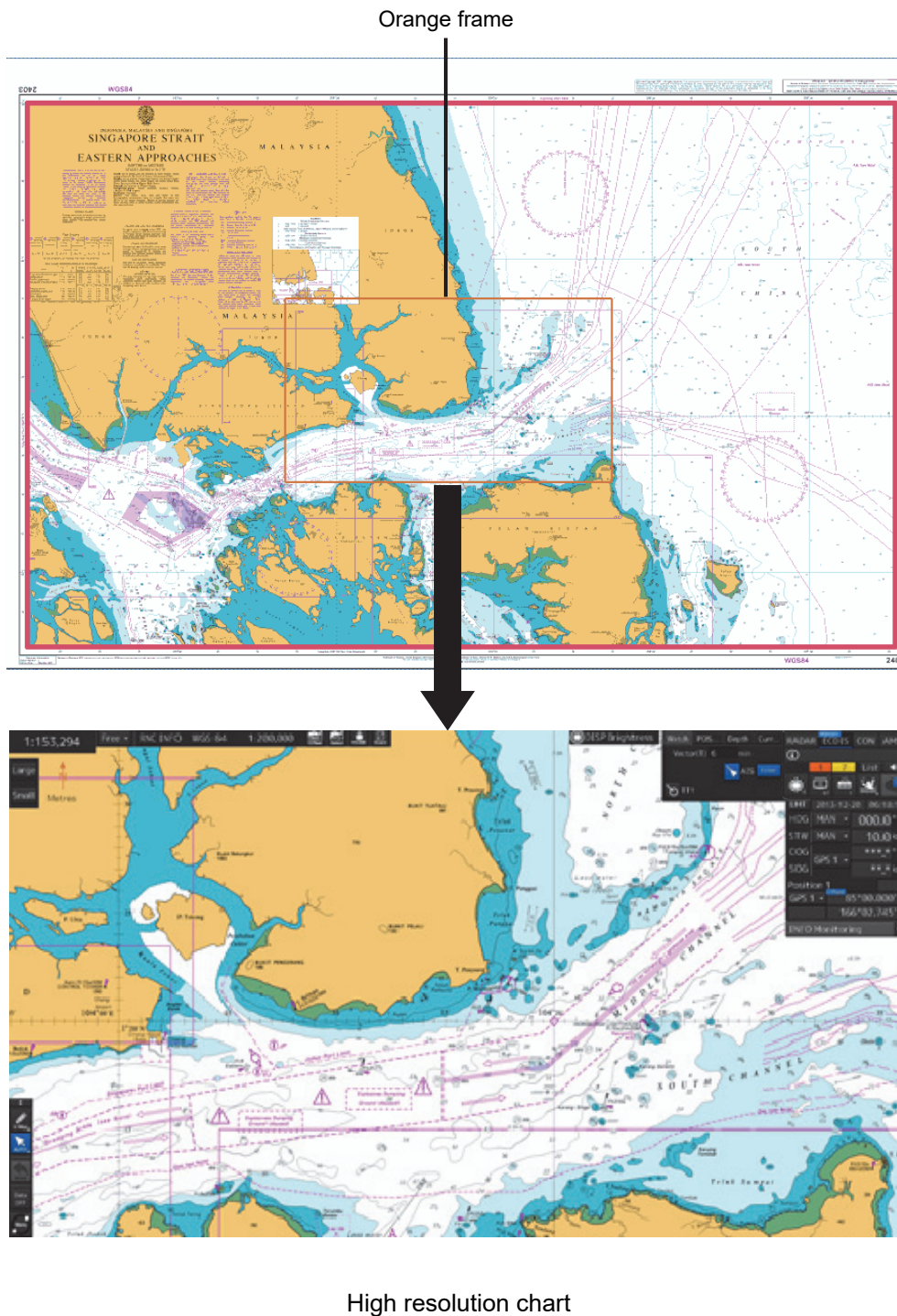

8.9.5 Displaying the note and diagram (ARCS only)

You can display the note and diagram list defined by the current chart.

1 Right-click on the chart

The context menu is displayed.

2 On the Context menu, click on the [Note and Diagram].

The [Note and Diagram] dialog box appears.

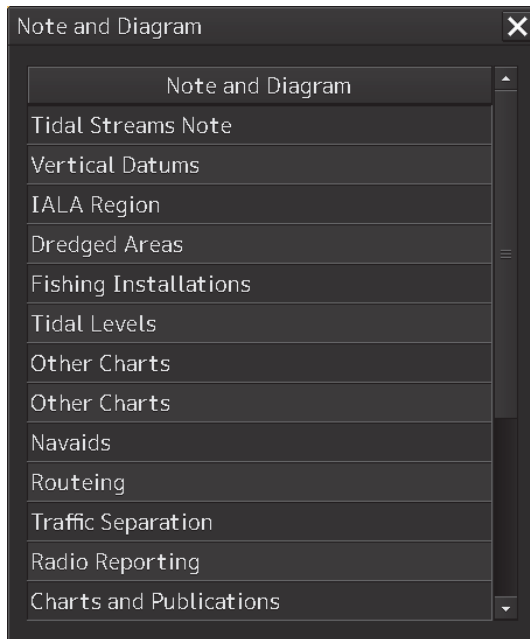

3 Click on the item you want to display. The note or diagram on the corresponding chart is displayed.

Clicking the [X] buttons, the dialog box is closed and the chart display returns to the original display position.

8.10 Multi View Display and Wide Range View Window Display of Charts

The multi view display function divides the chart window into two windows and displays the same chart or different charts separately in these two windows.

Note

ARCS and C-MAP Ed.3 cannot display charts of other models simultaneously.

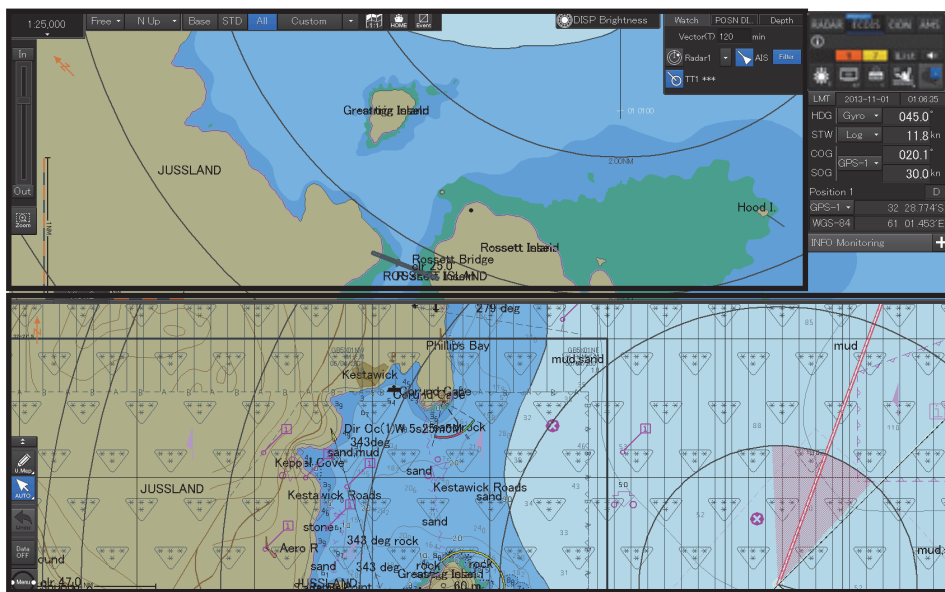

Example of Multi Window Display (Top-Bottom)

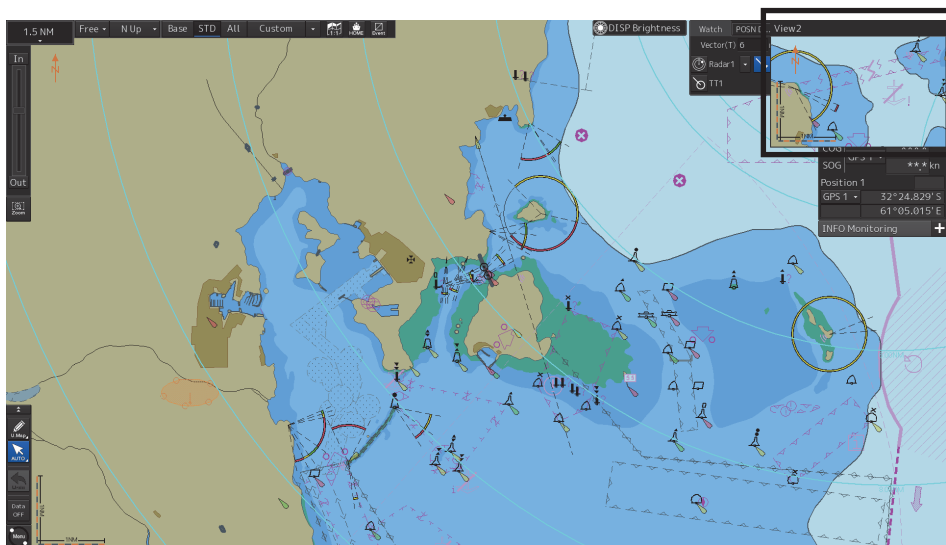

Example of Multi Window Display (Picture in Picture)

8.10.1 Display of multi view

8.10.1.1 Displaying multi view

- 1 Click on the [Menu] button on the left toolbar.

The menu is displayed.

- 2 Select [View] - [Multi View Mode] on the menu.

The [Multi View Mode] dialog box appears.

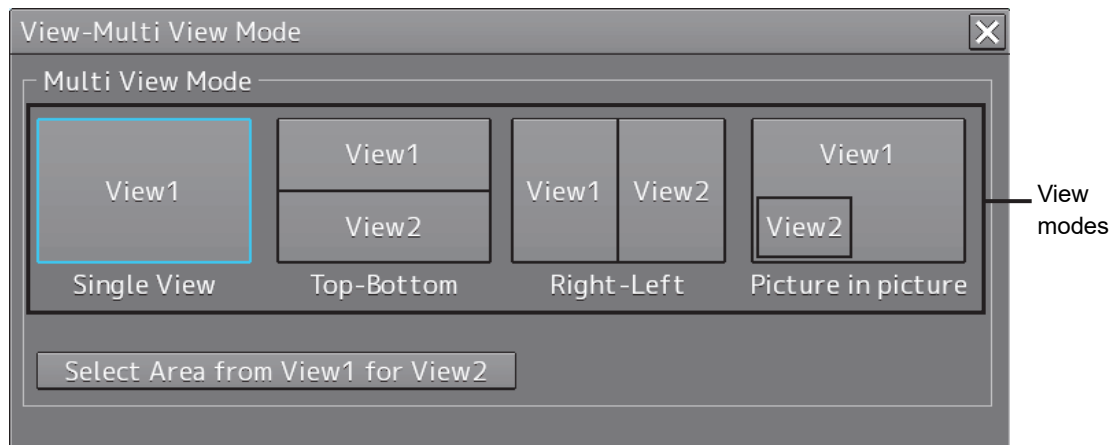

- 3 Click on a multi view mode to select it.

The selected multi view mode takes effect.

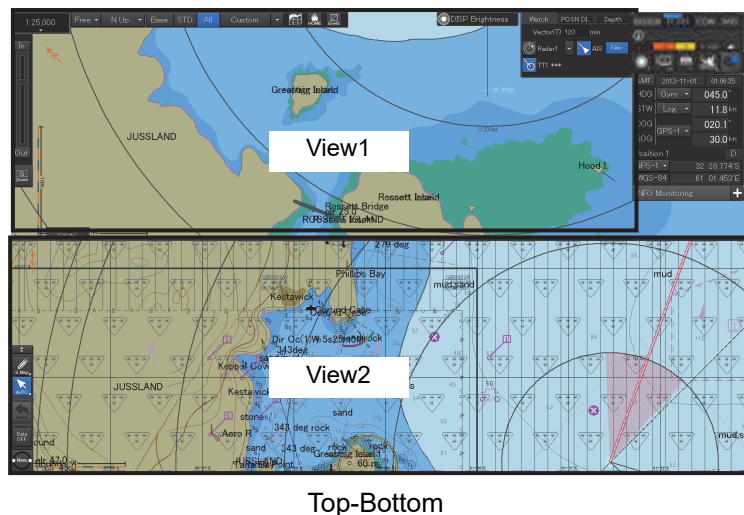

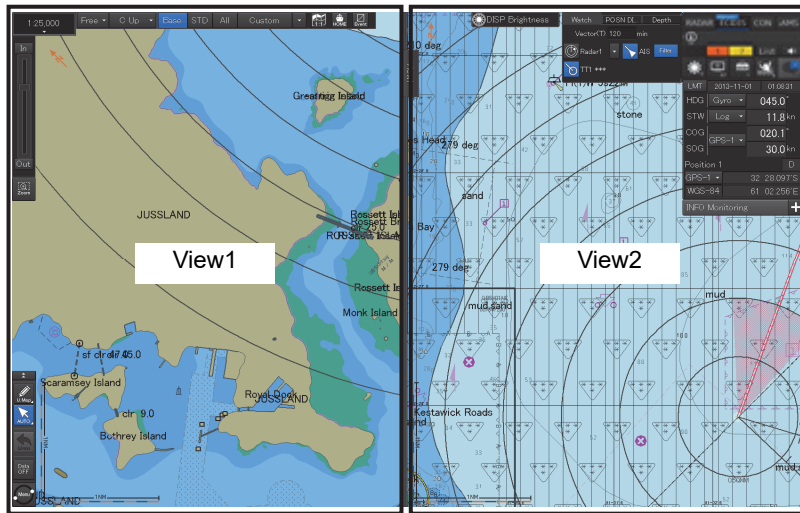

Right-Left

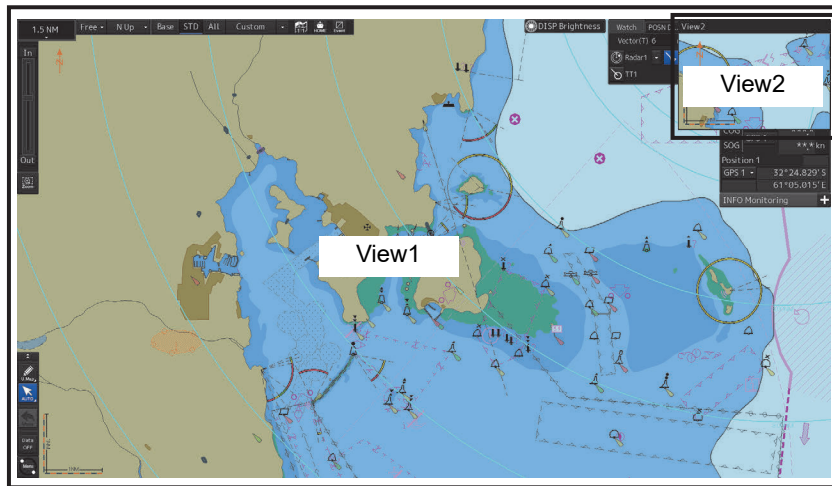

Picture in picture

8.10.1.2 Multi view operation procedure

[Operation When Manipulating Multi View]

- The same view is displayed in View1 and View2.
- Except for the items that can be set up separately in View2, View1 and View2 are displayed by linking.
- Rubber bands during create or edit operation (such as Route Planning) can only be displayed in active view.
- EBL/VRM and EBL maneuvers are shared between View1 and View2 and the same contents are displayed (however, the contents may differ depending on the setting of the measurement reference point.).

Note

The bearing mode of View2 operates by interlocking with the bearing mode of View1.

[Specifying an area to be displayed in View2]

In View1, you can specify an area you want to display in View2.

- 1** Click on the [Select Area from View1 for View2] button in the [Multi View Mode] dialog.

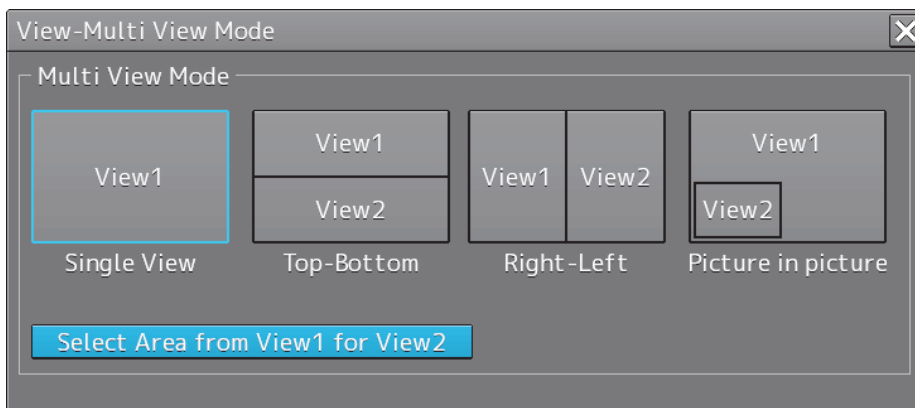

The button is displayed in reverse video.

- 2** Move the cursor to View1.

The cursor changes to the range selection cursor.

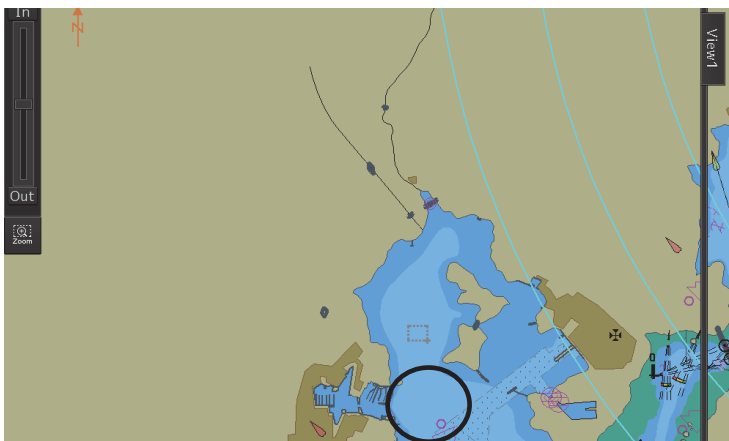

3 Drag the cursor and specify an area you want to display in View2.

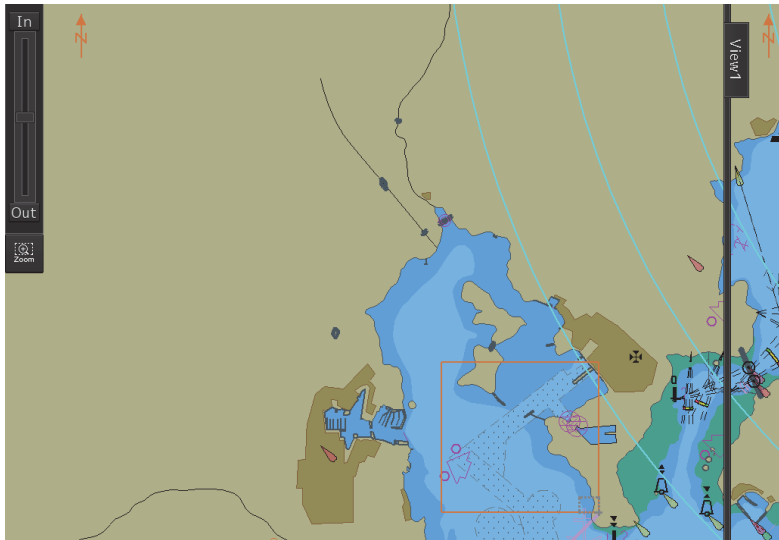

4 Click on.

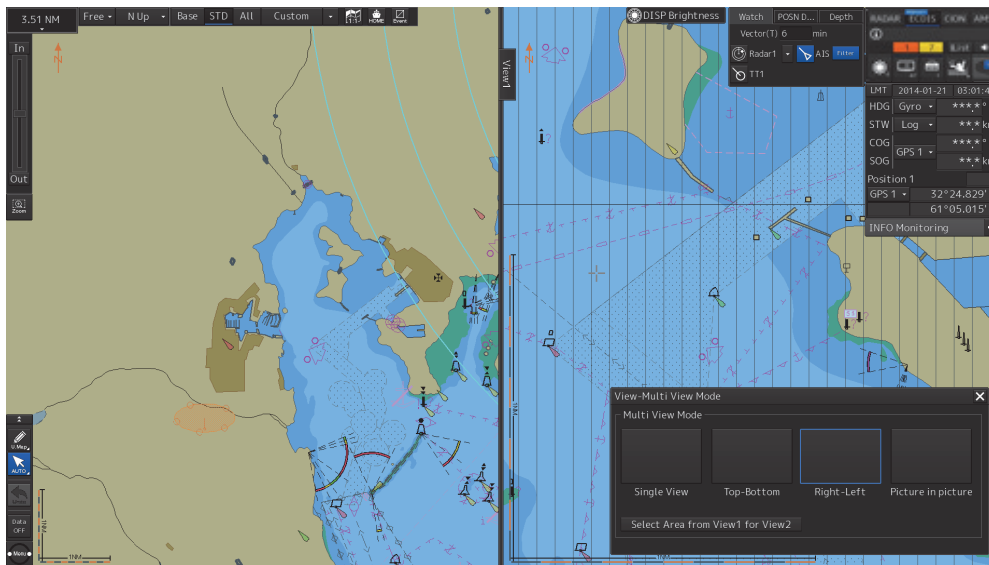

The specified range is displayed in View2.

The [Select Area from View1 for View2] button is displayed in normal video.

[Selecting a View]

Various operations can be performed in the selected view.

- 1 Click on the view you want to make active.

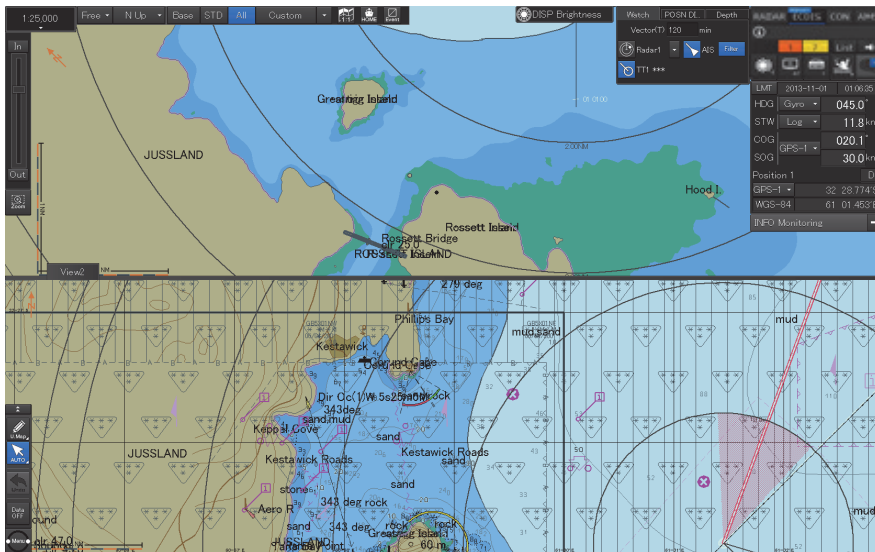

The clicked view becomes the active view.

Which view is active can be checked in active information display.

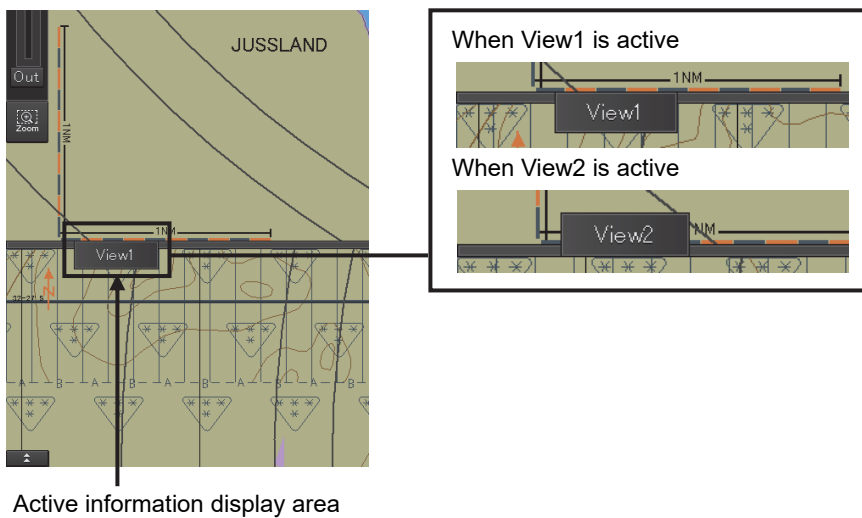

Active information display area

[Moving the Boundary Line of View]

When the view mode is either Top-Bottom or Right-Left, the boundary line of view can be moved.

- 1 To move the boundary line of view, click on the boundary line.**
- 2 When the cursor changes to the arrow shape shown below, move the boundary by dragging the cursor to the arrow directions.**



[Moving View2]

When the view mode is Picture in picture, the position of View2 can be moved.

- 1 Click on the title bar of View2**
- 2 When the cursor changes to the arrow shape shown below, move View2 by dragging the cursor to the arrow directions.**



8.11 Verifying Object Information (Pick Report Function)

Each of the objects on the chart has its own attributes (e.g. lighthouse, buoy, depth contour, land and river).

For example, if an object is a lighthouse, attributes such as lighting color and frequency can be read out. If the object is depth contour, the water depth can be read out.

Attribute information of these objects can be read and verified by using the pick report function.

The pick report displays the following information.

- S-57 chart
- C-MAP chart
- ARCS chart
- AIO
- Manual update

8.11.1 Pick Report of the S-57 chart

8.11.1.1 Displaying a Pick Report of the S-57 chart

- 1 Click the right button on the chart.



A pick mark and the context menu are displayed.

2 Click on [Cursor Pick] on the context menu.

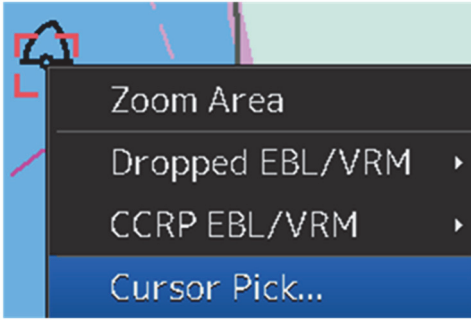

[Pick Report] dialog box appears.

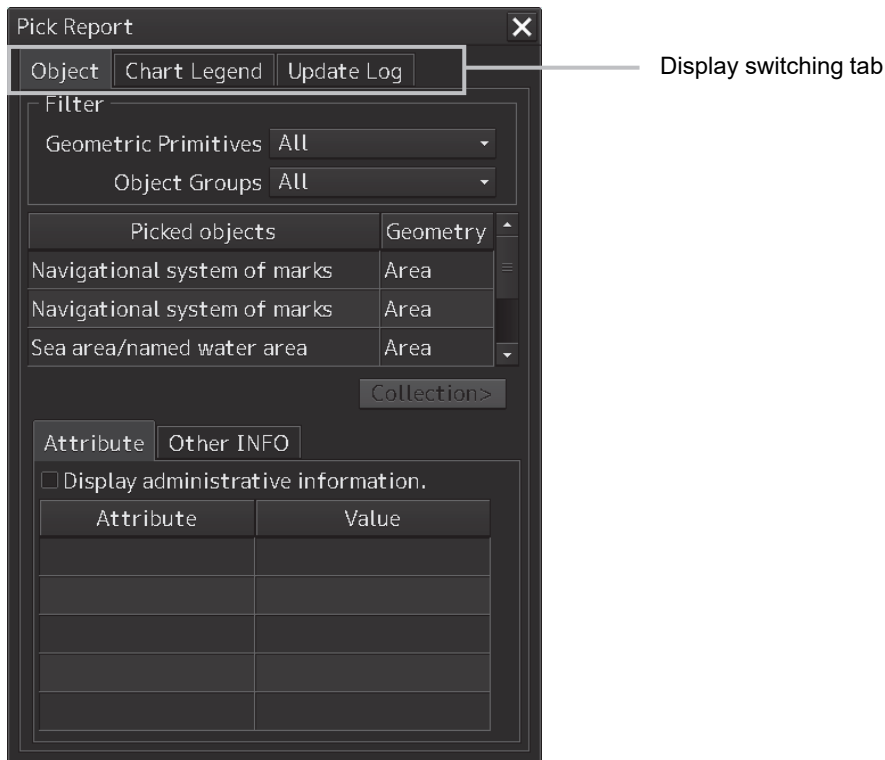

Display switching tab

This tab switches the information that is displayed. When the [Object] (object information) tab is clicked on, object information is displayed. When the [Chart Legend] tab is clicked on, chart information is displayed. When the [Update Log] tab is clicked on, chart update history is displayed.

8.11.1.2 Verifying Object Information

When the [Object] tab on the display switching tab is clicked on, object information is displayed.

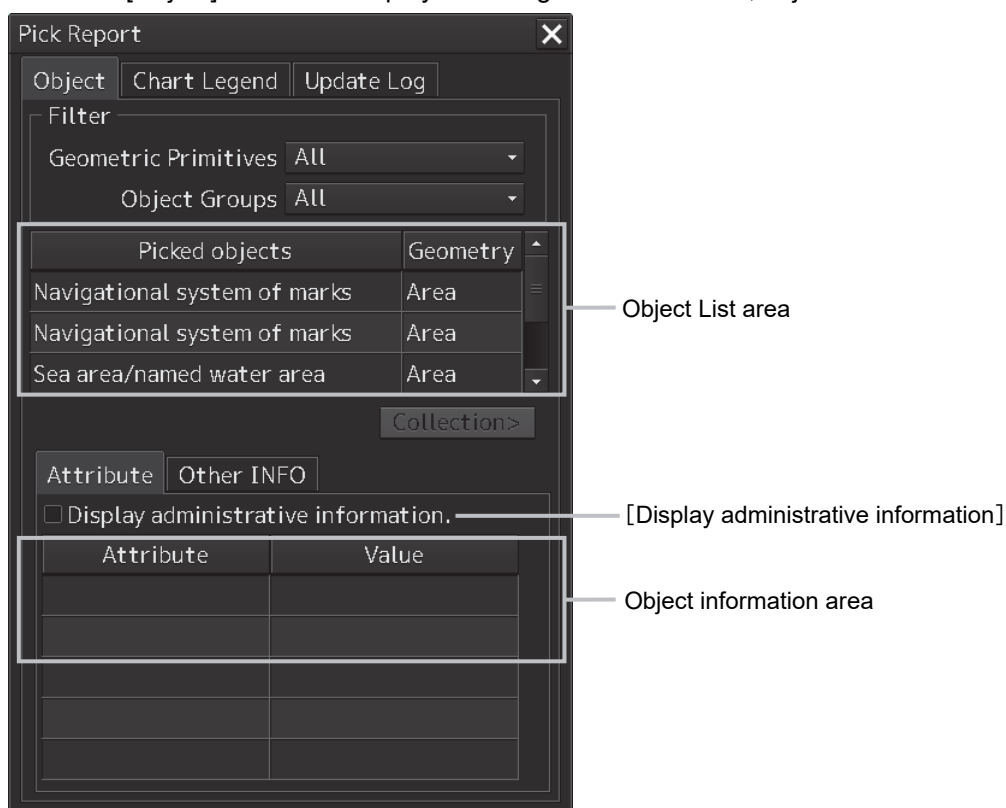

Object list area

The object within the pick cursor and its geometry are displayed in the object information area.

When an object is selected in the object list area, the selected object is displayed on the map in highlight mode in the case of the S-57 chart.

[Display administrative information]

When this item is selected, the attributes of the administrative information and the contents are displayed.

Object information area

Information (attributes) of the object that was selected from the object list is displayed.

The screenshot shows the 'Pick Report' window with the following details:

- Object Information Table:**

Picked objects	Geometry
Landmark	Point
Radio station	Point
Magnetic variation	Area
- Attribute Information Table:**

Attribute	Value
Function	light support
Height	25m
Object name	Worm Head
Pictorial representation	GBTESTPC.TIF
- Additional Information View:**

Attribute	Value
Tidal stream - panel values	View Table

Displaying an additional information file

The additional information file on the object that was selected from the object list is displayed in [Value] in hyperlink format.

Additional information files include text files (extension.TXT) and image files (extension.TIF).

Example: Image file

[GBTESTPC.TIF](#)

When Hyperlink is clicked on, the additional information file is displayed in a separate dialog box.



[View Table] button

When the [View Table] button of [Value] is clicked on, the data is displayed in a separate dialog box in the format that is specified as the attribute.

View Table			
Tidal Station			
Lookinghaven			
Tidal Station ID			0
Hours	Set	Drift	
	[deg]	[kn]	
Before High Water	-6	150	0.5
	-5	190	1.2
	-4	197	1.3
	-3	205	1.2
	-2	208	0.7
	-1	260	0.4
High Water	0	355	0.8
After High Water	+1	4	1.4
	+2	20	1.8
	+3	20	1.6
	+4	25	1.2
	+5	20	0.7
	+6	0	0.0

Tidal stream - panel values

View Table		
	amplitude	phase
M2	0.962	165
S2	0.361	243
K1	1.223	097
O1	0.875	143

Tide - value of harmonic constituents

Accuracy information and symbol addition information of an object

When the [Other INFO] tab is clicked on, the accuracy information and the symbol addition information of the object are displayed in the object information area.

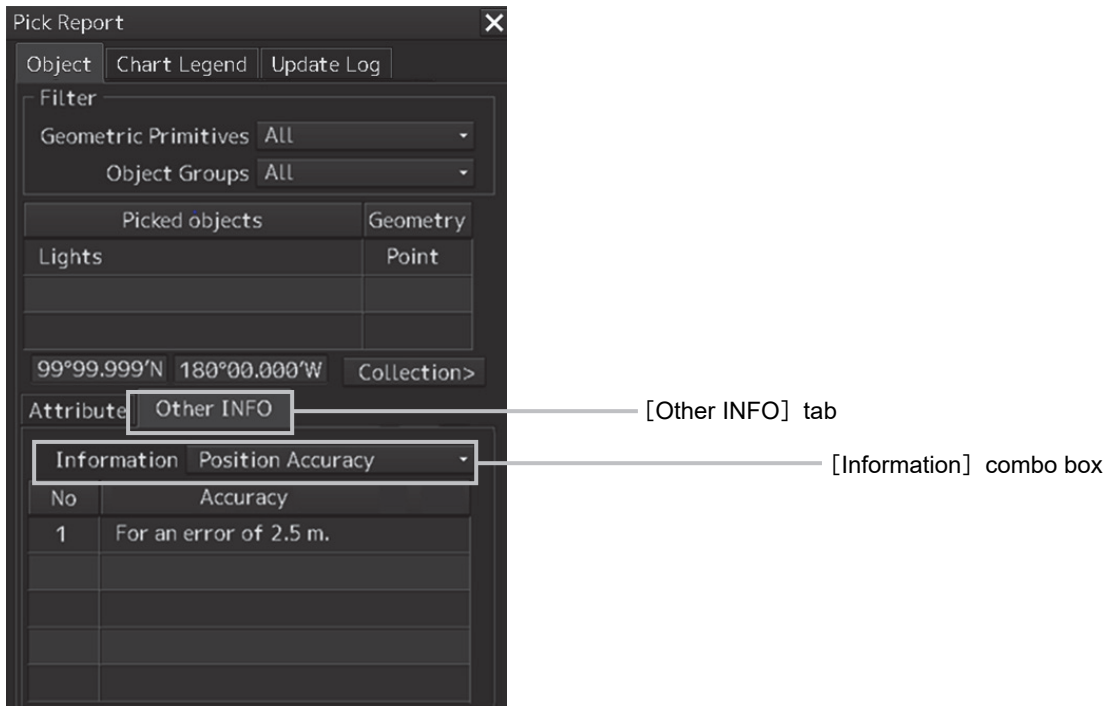

Each information item can be selected and displayed by using the [Information] combo box.

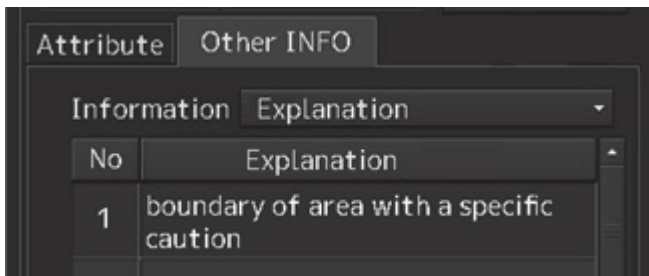
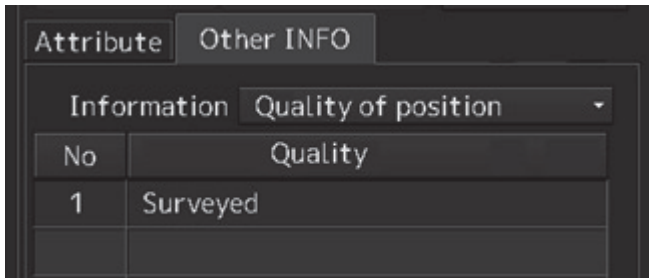

Coordinate display of an Unknown object

When an Unknown object is selected from the object selection list on the pick report screen, a text box is displayed indicating the coordinate of one representative point of Unknown objects.



Pick report collection object display

The collection object that is linked to the object that is selected from Picked objects is displayed. Three collection object types are available: Aggregation, Association, and Stacked on/Stacked under. When the [Collection] button is clicked on, a Collection objects list is displayed. When [Back] button is clicked on after the list is displayed, the Picked Object list is displayed.

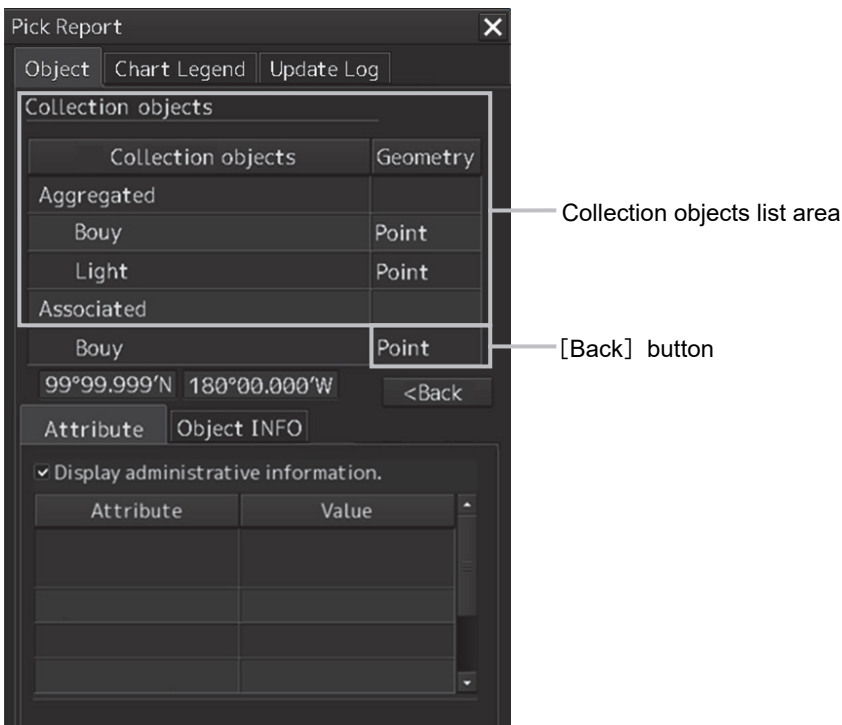
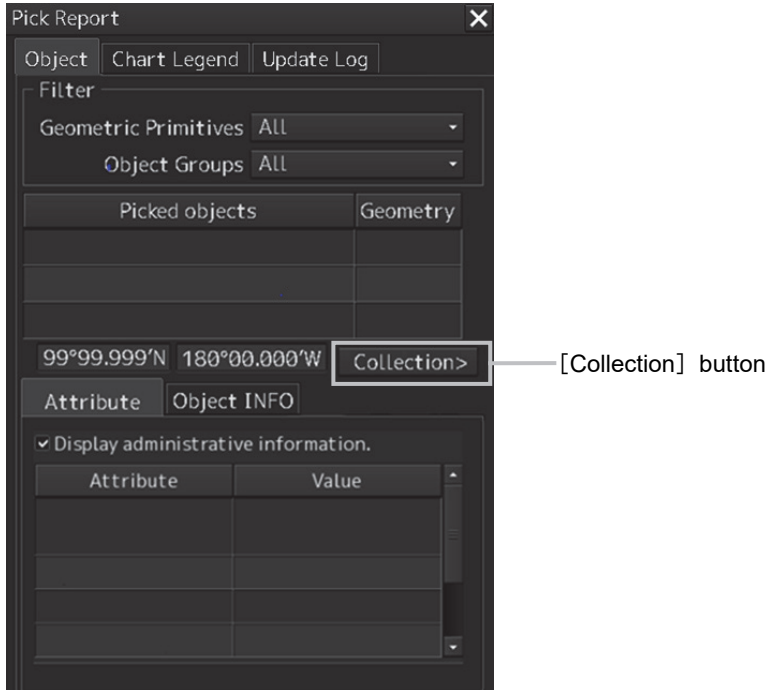

When no collection object is linked to the selected object, the Collection button is displayed as Disabled.

8.11.1.3 Verifying Chart Information

When the [Chart Legend] tab of the display switching tab is clicked on, chart information is displayed.

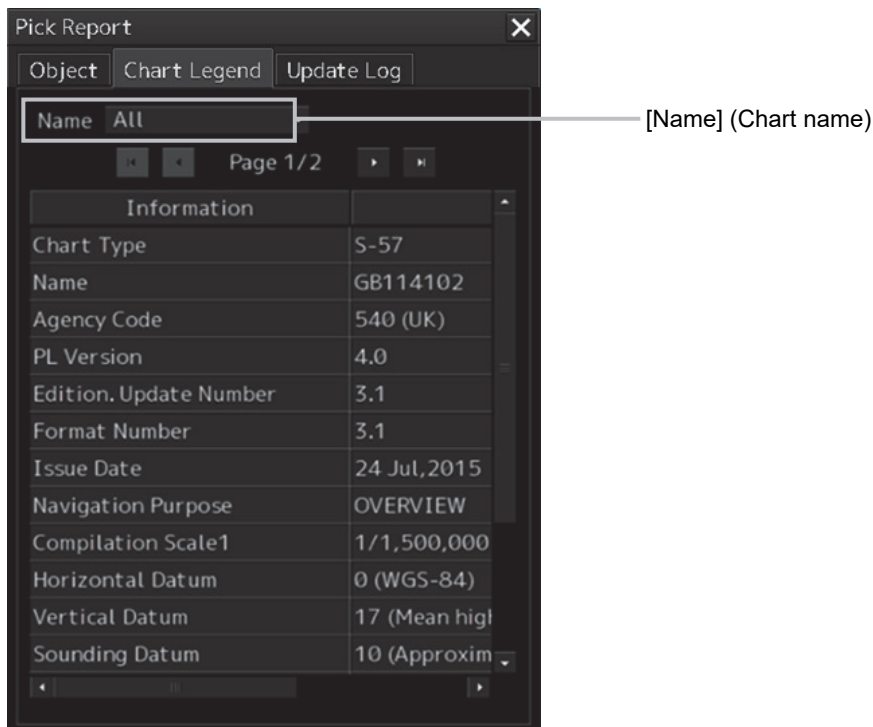

[Name] (Chart name)

When there are multiple charts on the selected chart position and a chart is selected from the list, the information of the chart is displayed. When [All] is selected from the list, information on all the charts is displayed.

Display of Zone Of Confidence

If Data Quality Indicator of the chart information is depth data, hyper link selection is displayed on the list. If hyper link is selected, the Zone of Confidence dialog is displayed.

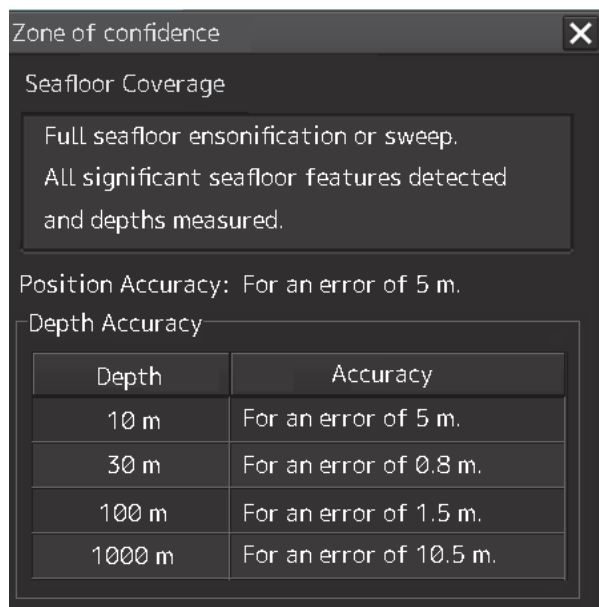

8.11.1.4 Verifying Chart Update History

When the [Update Log] tab of the display switching tab is clicked on, chart update history is displayed.

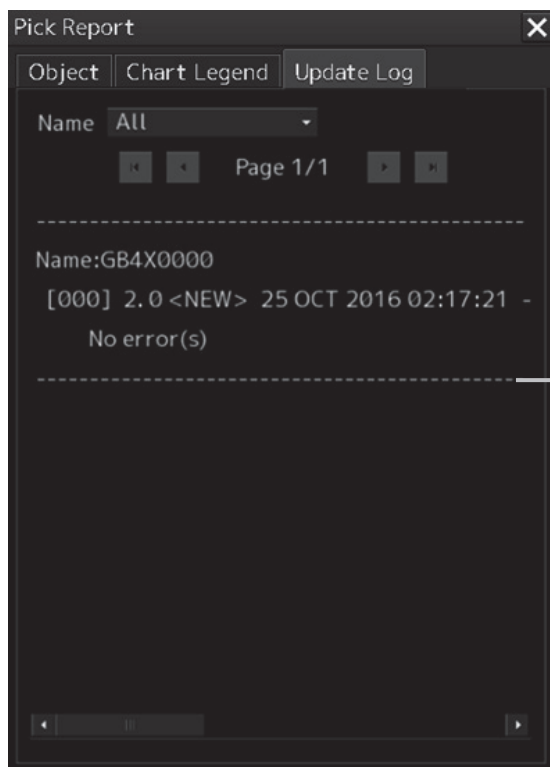

Separator of chart update history

If the chart update history consists of multiple pages and cannot be displayed on one page of the screen, drag the scroll bar to display the rest.

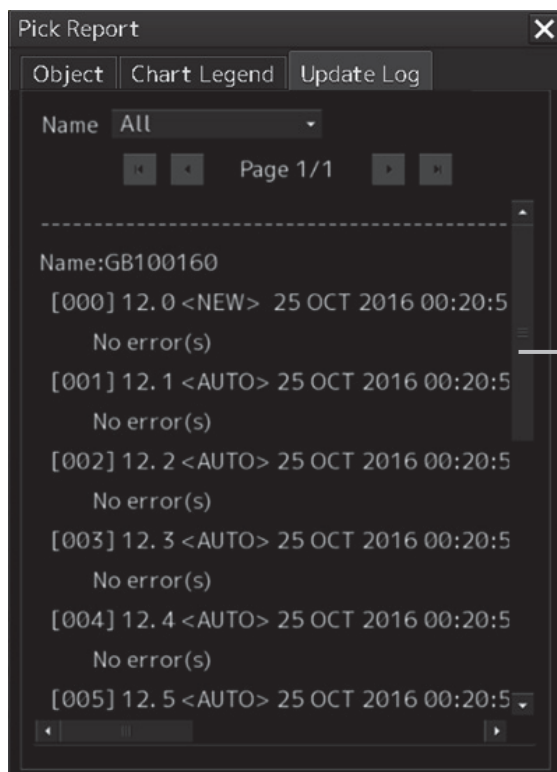

Scroll bar

8.11.2 Pick report of the C-MAP chart

For C-MAP, T & P can be selected instead of AIO with the Object Groups filter on the Object tab. The following contents are displayed from the [Update Log] (chart update history) tab.

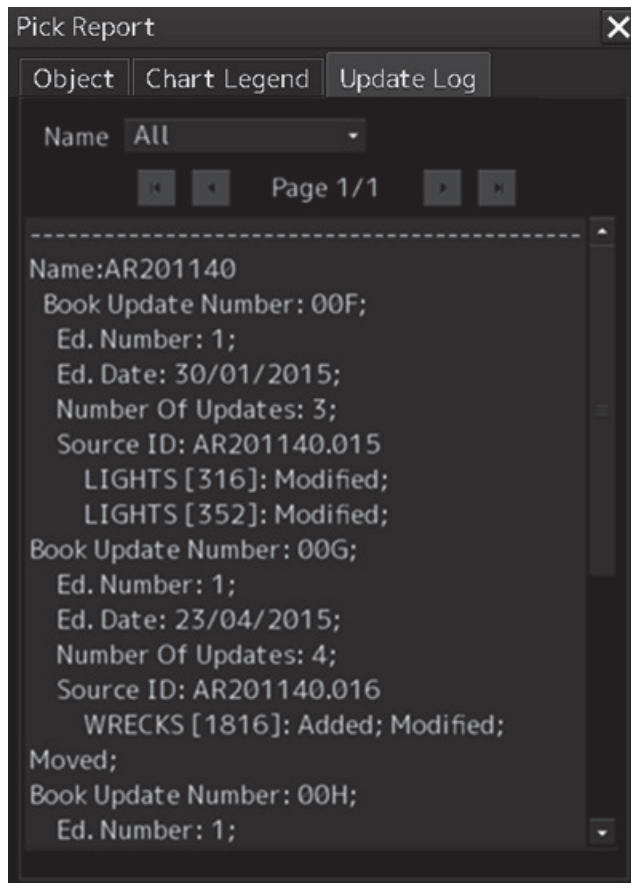

8.11.3 Pick report of the ARCS chart

The display method is the same as that of S-57.

In the case of ARCS, only the chart information area is displayed.

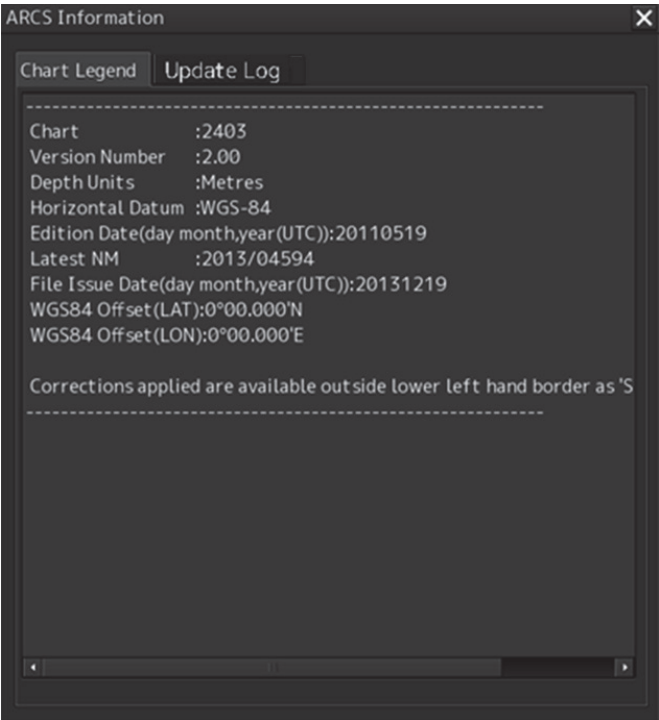

8.12 Marking the Position of Own Ship with an Event Mark

While sailing, you can mark the position of own ship on the chart with an event mark.

- 1 Click on the [Event] button in Chart Information Area.



An event mark is marked to the position of own ship and the [Property] dialog box of event marks appears.

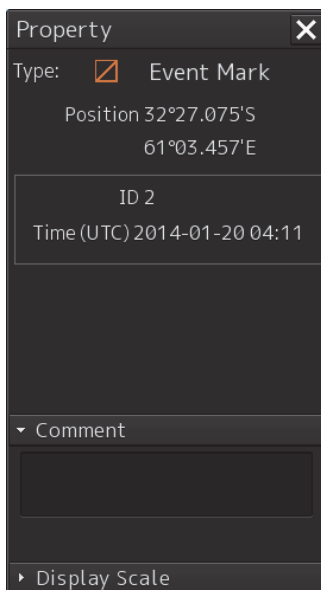
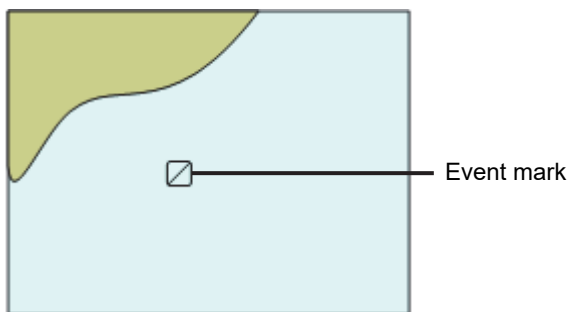

The display position, ID, and date and time of creation of the event mark are displayed in the [Property] dialog box.

Enter any desired comment in the [Comment] input box.

[Deleting the Event Mark]

The event mark can be deleted by either of the following methods.

- Right-click on the event mark and click on [Delete this object] on the Context menu that appears.
- Click on the event mark when in the Delete mode.

8.13 Displaying Radar Images on a Chart by Overlaying

Radar images can be displayed by overlaying on the chart.

Note

- To perform overlay display of radar images, the radar function must be installed and radar images must be received from the radar system.
- If the radar system displays a short-range image and a long-range image on the ECDIS at the same time, the radar image on the ECDIS may be distorted.
- While the radar image is displayed, the display range can be changed in 11 steps (0.125/0.25/0.5/0.75/1.5/3/6/12/24/48/96 NM).
- In the case of ARCS charts, the display range varies with the chart to be displayed. If a range over 120 NM is selected, radar image display automatically turns off.
- The screen display color will automatically change to [Day3] when RADAR Overlay is turned on. (When the screen display color is Dusk/Night, automatic switching does not occur.)
- When Multi View is used, radar images cannot be displayed on View2.

8.13.1 Turning On/Off overlay display

- 1 Click on the [Menu] button on the left toolbar.
The menu is displayed.
- 2 Select [View] - [Options] - [RADAR] on the menu.

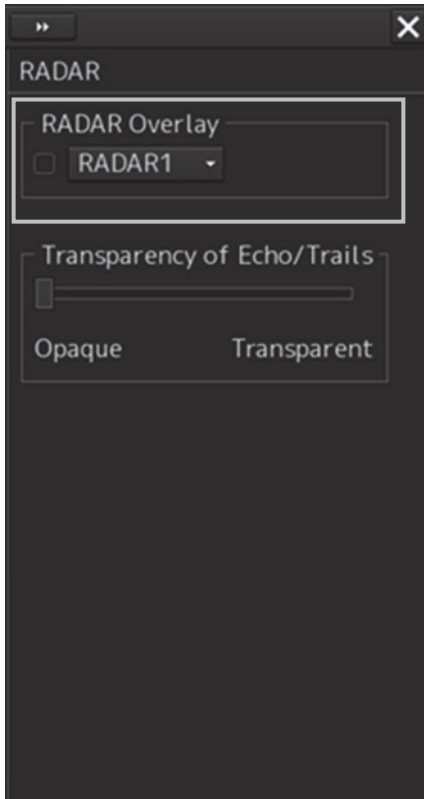

- 3 Select the [RADAR Overlay] check box.
Radar overlay display is set to On.
- 4 Select a radar system to be used from the pull-down menu.

Memo

- When multiple radar systems are available, click the [RADAR Overlay] combo box and then select the radar image to be used from the pull-down menu that appears. (Radar images can be selected from the maximum of 8 systems, [RADAR1] to [RADAR8].)
- Even if the connection between this equipment and the radar system is not set or the connection setting is cancelled, reconnection is set automatically. As a result, the overlay display of the radar image is continued.

[Transparency Setting of Echo/Trails]

Transparency can be set up by clicking the [Transparency of Echo/Trails] slider handle to right and left.

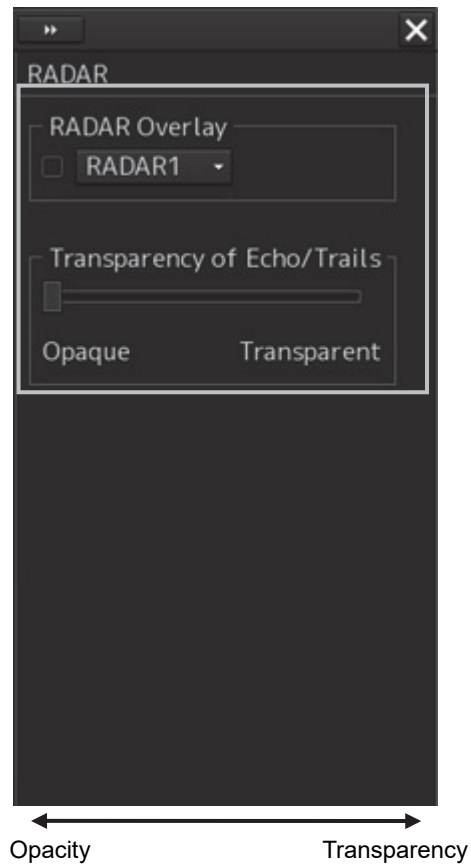

8.13.2 Turning On/Off range ring display

- 1 Click on the [Menu] button on the left toolbar.
The menu is displayed.
- 2 Select [View] - [Options] - [Tools] on the menu.

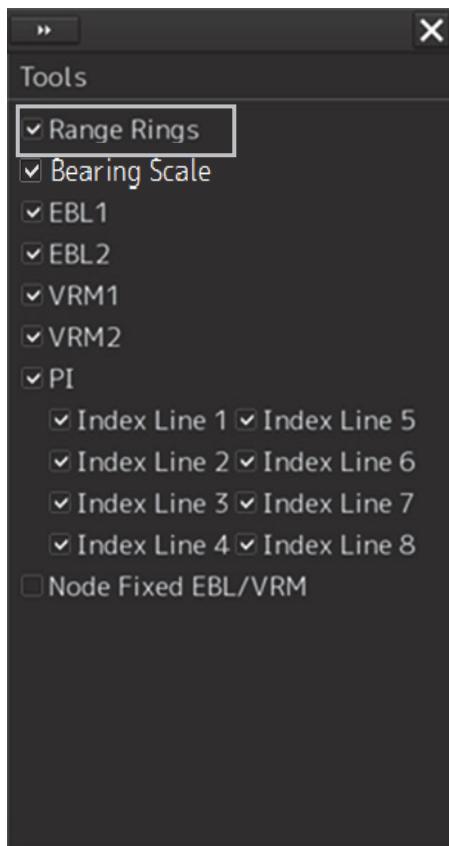

- 3 To show range rings, select [Range Rings].
To hide range rings, clear it.

8.13.3 Turning On/Off bearing scale

- 1 Click on the [Menu] button on the left toolbar.
The menu is displayed.
- 2 Select [View] - [Options] - [Tools] on the menu.

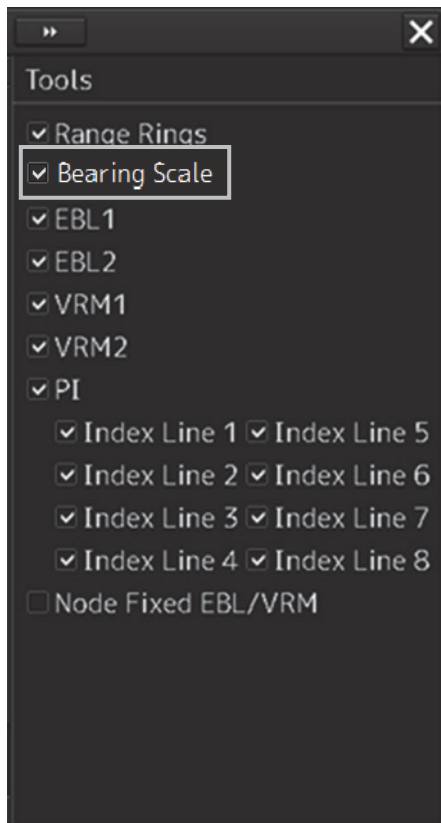

- 3 To show a bearing scale, check [Bearing Scale].
To hide a bearing scale, clear it.

8.13.4 Radar image adjustment

Radar images can be adjusted using the [RAIN], [SEA] and [GAIN] dials on the keyboard operation unit.

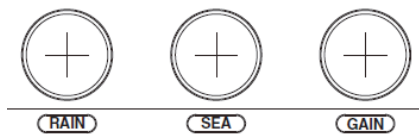

[RAIN] dial: Suppressing rain and snow clutter

The [RAIN] dial suppresses clutter caused by rain and snow. Turning the [RAIN] dial to the right enhances the contours of targets that are hidden in images of rain and snow. Take care not to over-adjust this dial. Otherwise, you may miss small targets. This dial also reduces sea clutter. So, using both the [RAIN] and [SEA] dials is more effective. Normally, keep this dial turned as far as possible to the left.

[SEA] dial: Suppressing sea clutter

The [SEA] dial lowers the gain at a short range to reduce sea clutter. Turning the [SEA] dial to the right increases the effect of suppressing sea clutter. Take care not to over-adjust this dial. Otherwise, you may miss small targets like buoys and small boats.

[GAIN] dial: Adjusting sensitivity

The [GAIN] dial adjusts the gain of RADAR echo. Turning the [GAIN] dial to the right increases the gain and widens the range in which RADAR echo can be observed.

Take care not to over-adjust this dial, as reception noise on screen increases. This worsens the contrast and makes it more difficult to tell the difference between targets and RADAR echo. Alternatively, turning the [GAIN] dial to the left to view at a short range or screens containing closely packed targets, decreases the gain making targets easier to view. Take care not to over-adjust this dial. Otherwise, you may miss small targets.

Memo

If the keyboard operation unit is not available, the radar image can be adjusted using [Rain], [Sea] or [Gain] slider in the setting dialog of [Settings]- [Signal Process (Basic)] on the menu.

The [Signal Process (Basic)] setting dialog can also be displayed by operating the [RAIN], [SEA], or [GAIN] dials on the keyboard operation unit.

When one of the dials is held down (for 2 seconds or more) at operation termination, the setting dialog is closed.

For the details of the [Signal Process(Basic)] setting dialog, refer to "18.2 Basic setting of radar signal processing".

8.14 Setting a true bearing

When a gyro signal is input by using GYRO I/F, sometimes the true bearing value indicated by the master gyro and the true bearing value indicated by this equipment do not match.

In this case, set the true bearing value of this equipment to the value of the master gyro by using the following procedure.

- 1 Click on the [Menu] button on the left toolbar.**

The menu is displayed.

- 2 Click on [Settings] - [General] on the menu.**

The [General] dialog is displayed.

- 3 Click on the [GYRO Setting] input box.**



- 4 Enter the master gyro value through the software keyboard.**

8.15 Setting an own ship's speed

8.15.1 Switching an own ship's speed sensor

- 1 Click on the STW Source combo box of the own ship's information

LMT	2014-01-17	19:25:00
HDG	Gyro ▾	045.0°
STW	Log ▾	**.* kn
COG		020.1°
SOG	GPS 1 ▾	30.0 kn
Position 1		DGPS
GPS 1 ▾		29°21.642' S
WGS-84		64°39.622' E

- 2 Select a sensor source in the [STW] combo box. Any of the following sensor sources can be selected.

MAN

Logx ("x" indicates the equipment number)

When [Menu] is selected, the [Sensor Selection/Status] dialog is displayed.

When [MAN] (Manual) is selected, a speed through water can be input in the [Sensor Selection/Status] dialog.



- When using 1-axis log, heading speed component can be detected, but transverse speed component cannot be detected. Then leeway effect (component drifted by wind) cannot be detected.
- When using 2-axes log, its accuracy in shallow waters may be deteriorated, and its speed in deep sea areas may be unable to be detected.
- When using a GPS, COG accuracy is less than $\pm 3^\circ$ at speed: from 1kn to 17kn, and is less than $\pm 1^\circ$ at speed: more than 17kn.

8.15.2 Entering the ship's heading/own ship's speed manually

When the device (example: LOG) that is connected to this equipment fails to function, the target tracking device and true motion display can be used by entering the ship's heading/own ship's speed manually by using the following procedure.

- 1 Select [Menu] from the corresponding combo box.



The [Sensor Selection/Status] dialog box appears.

- 2 To enter the ship's heading manually, select [Manual] from the [Heading] combo box. To enter the ship's own speed manually, select [Manual] from the [STW] combo box.
- 3 Click on the input combo box.

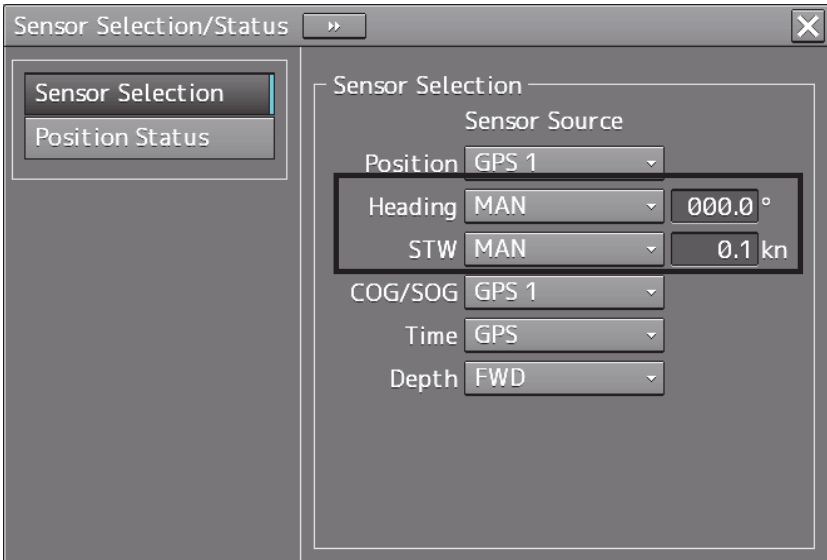

- 4 Enter numeric values through the software keyboard.

Section 9 Route Planning

⚠ CAUTION



Edit the navigation route according to the world geodetic system (WGS-84).
If you use the navigation route edited by a geodetic system other than the world geodetic system, an accident may occur.

The Route Planning function creates and edits a route of a ship in advance. A route comprises WPTs (waypoints) from the starting point to the arrival point and the straight lines (legs) that connect the WPTs.

9

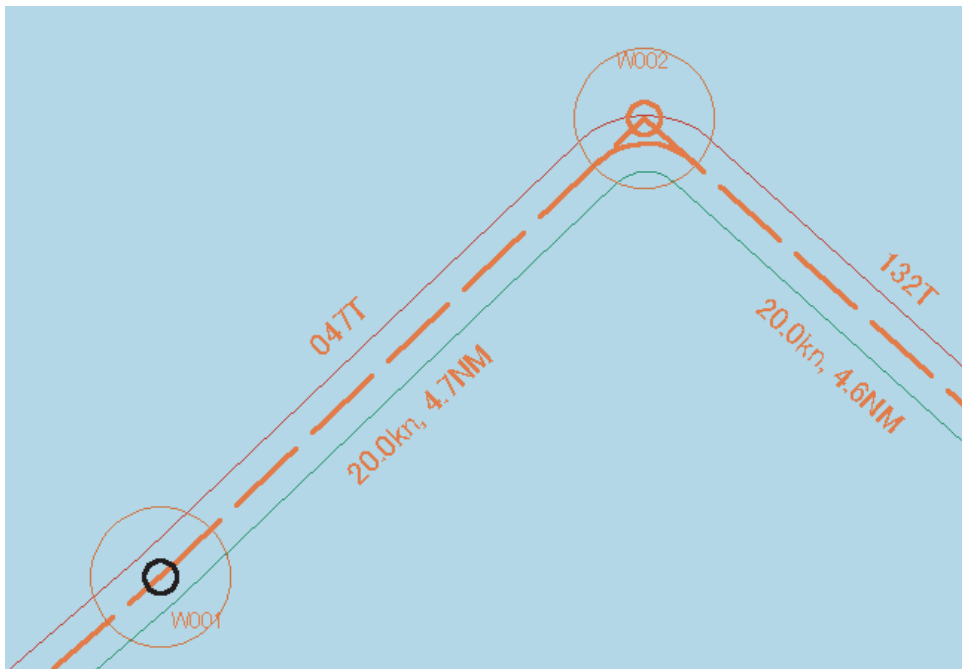

Route Planning Example

9.1 Overview of the Route Planning Function

Table editing function

This function enables creation of a route in table format by using the [Route Planning] dialog box.

A route is created by entering each WPT into the WPT list.

For the details of route planning with table editing, refer to "9.6 Planning a Route by Using Table Editing".

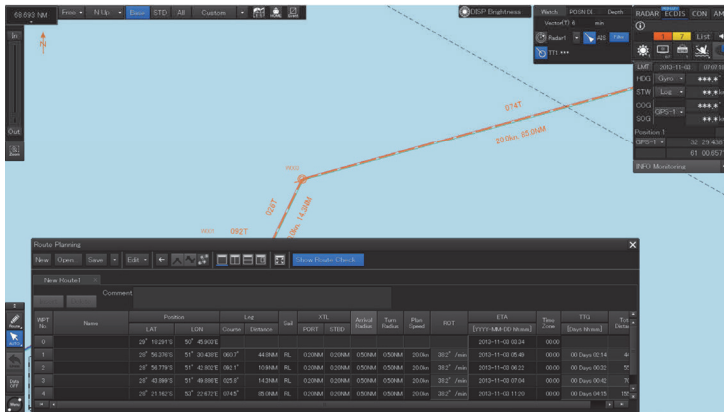

Graphic editing function

This function enables creating a route on a chart.

A route plan is created by adding a WPT on a chart.

For the details of route planning with graphic editing, refer to "9.7 Planning a New Route by Graphic Editing".

Route planning safety checking function

This function checks the safety of the planned route.

For the details, refer to "9.9.1 Checking a route based on the safety standards".

Route planning limit checking function

This function checks whether the planned route does not violate the pre-defined limit.

For the details, refer to "9.9.2 Checking a route based on the limits".

Navigation calculating function

This function supports the calculation of distance and bearing that are required for navigation.

For the details, refer to "9.10 Navigation Calculation Function".

Import/Export function

This function imports/exports a route file.

For the details, refer to "9.11 Importing/Exporting a Route File".

Note

- When a route is created exceeding the limit value, an error message is displayed and Route planning operation stops.
- If the distance between WPTs exceeds 150° in longitude, the route cannot be created.

9.2 Setting Route Display

Before creating a route, set route display (display/hide of the route information to be displayed on the screen) at route setting.

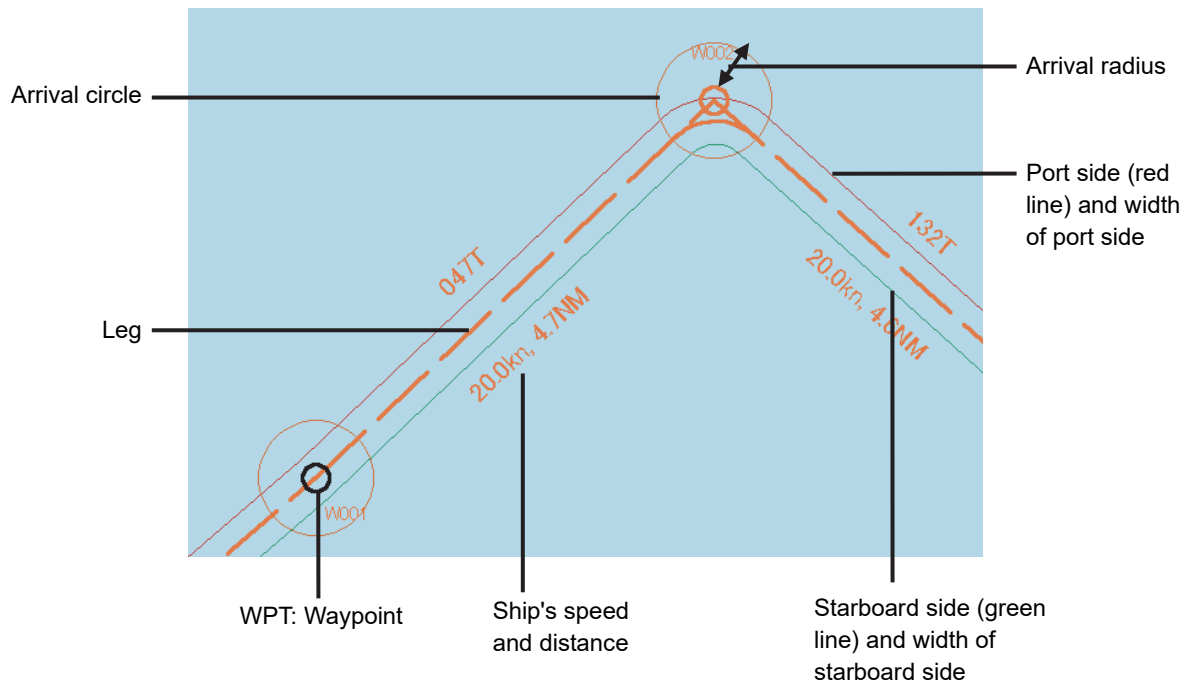

Use the following two dialogs for the setting.

9.2.1 Setting [Route] after selecting [View] - [Options] on the menu

- 1** Click on the [Menu] button on the left toolbar.
The menu is displayed.
- 2** Click on the [View] - [Options] - [Route] on the menu.
The "Route" setting screen is displayed.

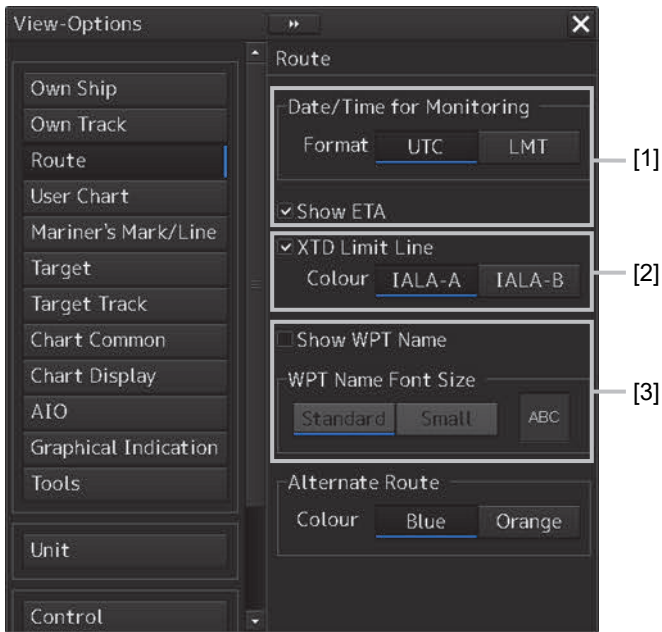

[1] [Show ETA]

By selecting the [ETA] check box, the display of the ETA (estimated time of arrival to WPT) becomes effective at route monitoring.

When [UTC] from [Format] is clicked, UTC is displayed and when [LMT] is clicked, LMT is displayed.

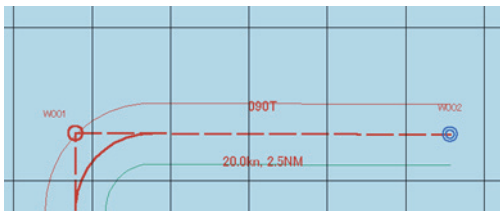

Not selecting the [ETA] check box

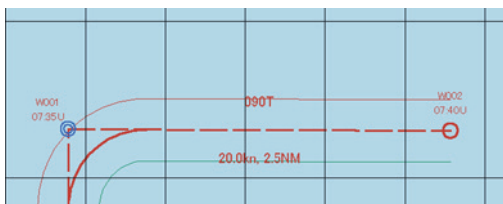

Selecting the [Show ETA] check box, and clicking [UTC] as the arrival time display format

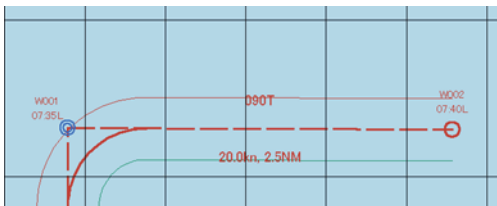

Selecting the [Show ETA] check box, and clicking [LMT] as the arrival time display format

[2] [Cross Track Limit Line]

When this item is selected, a cross track limit line is displayed.

When this item is selected, the line color can be set.

When [IALA-A] is clicked on, the starboard side is displayed in green and the port side is displayed in red.

When [IALA-B] is clicked on, the starboard side is displayed in red and the port side is displayed in green.

[3] [Show WPT Name](Show comment)

When this item is selected, a comment is displayed near the WPT.

When this item is selected, the character size of the comment can be set.

When [Standard] is clicked on, the comment is displayed in the standard character size.

When [Small] is clicked on, the comment is displayed in the character size smaller than the standard size.

9.2.2 Setting [Settings] - [Route] on the menu

1 Click on the [Menu] button on the left toolbar.

The menu is displayed.

2 Click on the [Settings] - [Route] on the menu.

The [Route] dialog is displayed.

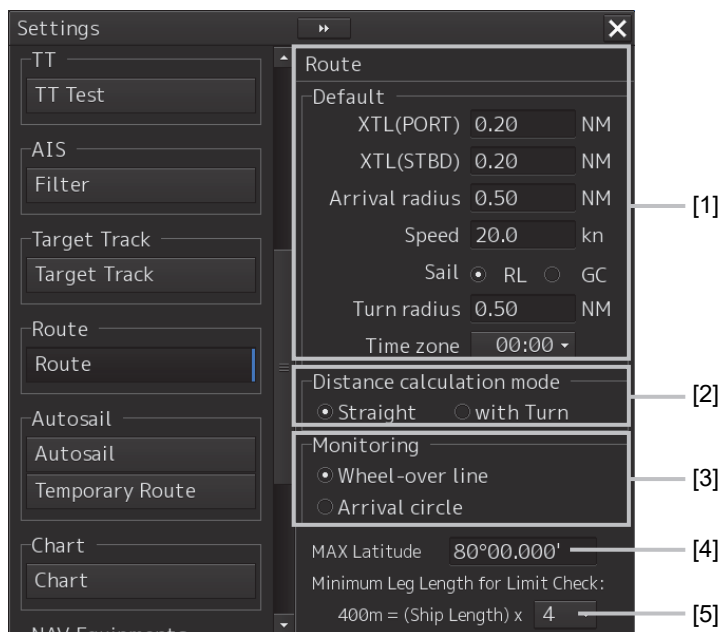

[1] [Default] (Factory settings)

Set factory settings of the route display that is created at route planning.

[XTD (PORT)]:

Set a port side cross track limit.

[XTD (STBD)]:

Set a starboard side cross track limit.

[Arrival radius]:

Set an arrival radius of WPT.

[Speed]:

Set a planned ship's speed.

[Sail]:

Select sailing mode.

- When [RL] is selected, the mode is set to Rhumb Line.

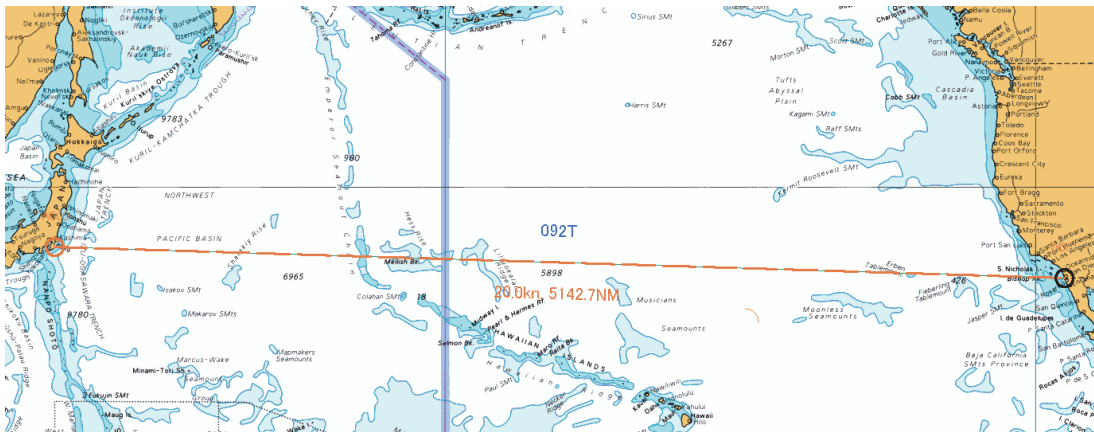

Display Example

- When [GC] is selected, the mode is set to Great Circle.

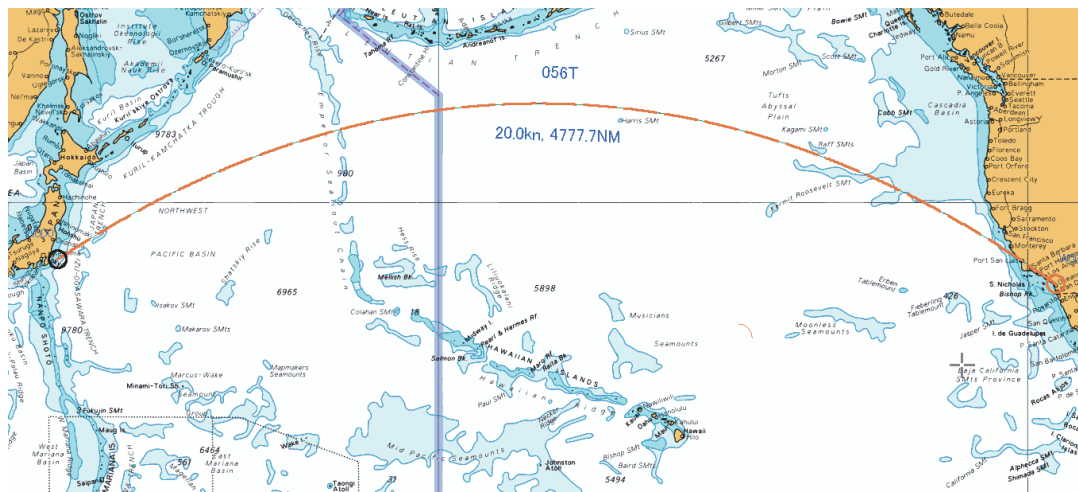

Display Example

[Turning Radius]:

Set a turning radius.

[Time zone] combo box:

Set a time zone.

[2] [Distance calculation mode]

Set a method for calculating a distance between WPTs.

When [Straight] is selected, a distance between WPTs is calculated with a straight line



When [with Turn] is selected, a distance between WPTs is calculated based on the expected route.

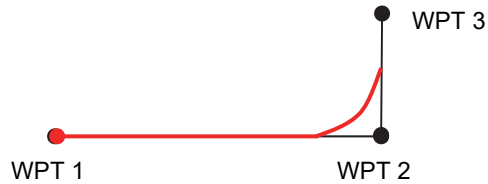

[3] [Monitoring]

Set a route monitoring method.

When [Wheel-over line] (steering line) is selected, monitoring is performed by using Wheel-over line (WOL) along each WPT.

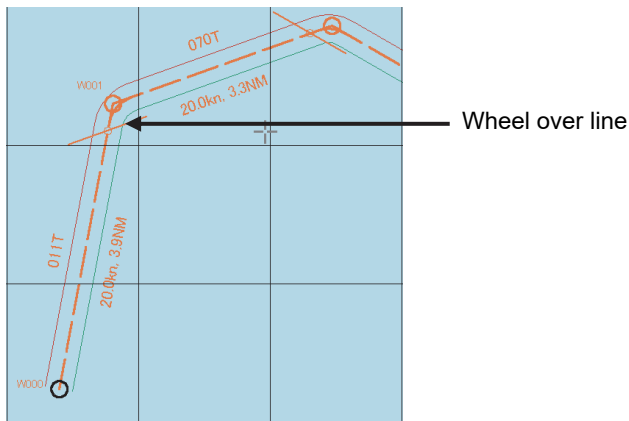

When [Arrival circle] is selected, monitoring is performed by using the arrival circle along each WPT.

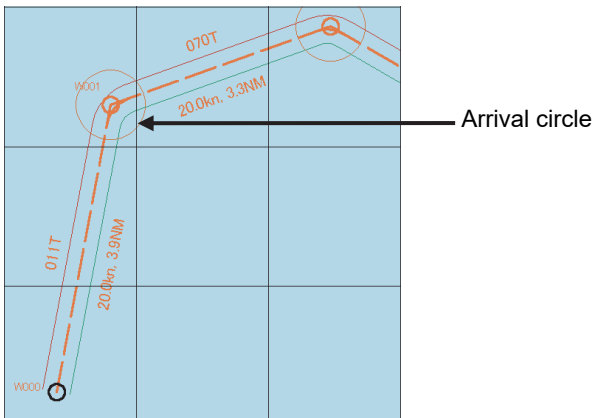

[4] [MAX Latitude]

Set maximum latitude.

A WPT can no longer be entered in a latitude higher than the latitude that has been set up.

If sailing is [GC], it is possible to create a route by automatically adding WPTs so as not to exceed the maximum latitude in the case of a route in which part of the leg passes a latitude higher than the maximum latitude.

If the maximum latitude is 60° or higher, a route can be created even if the GC leg exceeds 60°.

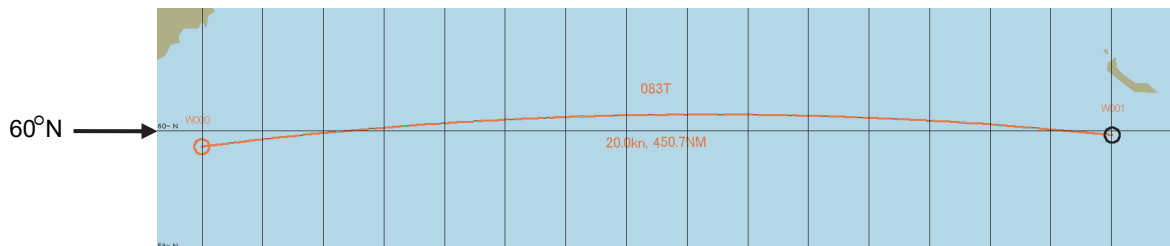

If the GC leg exceeds 60° when the maximum latitude is 60°, WPTs are automatically added and the route is adjusted so as not to exceed 60°.

WPTs (W001 and W002) in this example are added so as not to exceed the maximum latitude (60°).

The segment between W001 and W002 becomes an RL leg.

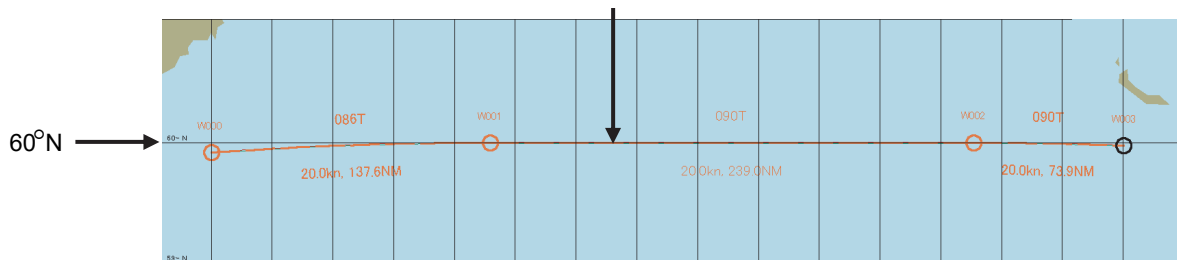

Note:

- A route cannot be created with a leg of 150° or higher in the longitudinal direction.
- Create a user chart at latitude 84° or lower.

[5] [Minimum Leg Length for Limit Check] combo box

Select a multiplier for determining the "minimum leg length" that is used for limit check from 1, 2, 4, 6, or 8.

Calculation expression: Minimum leg length = (Hull length) x multiplier

9.3 Starting and Ending the [Route Planning] Dialog Box

Plan a route on the [Route Planning] dialog box. The procedures for starting and ending the [Route Planning] dialog box are as follows.

9.3.1 Starting the [Route Planning] dialog box

- 1 Click on the [Menu] button on the left toolbar.
The top menu is displayed.
- 2 Click on the [Route Planning] button on the top menu.
The [Route Planning] dialog box appears on the screen.

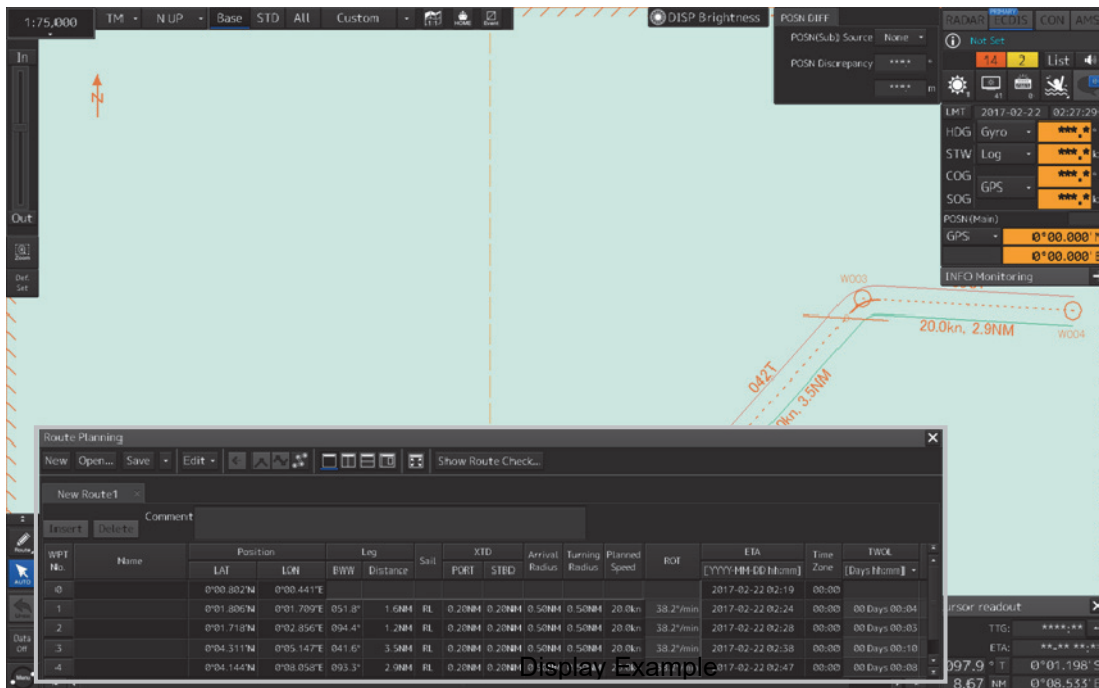

The width of the dialog box varies according to the screen size.

9.3.2 Ending the [Route Planning] dialog box

- 1 Click on the [X] button on the dialog box.

9.4 Name and Function of Each Section of the [Route Planning] dialog Box

The [Route Planning] dialog box comprises as below.

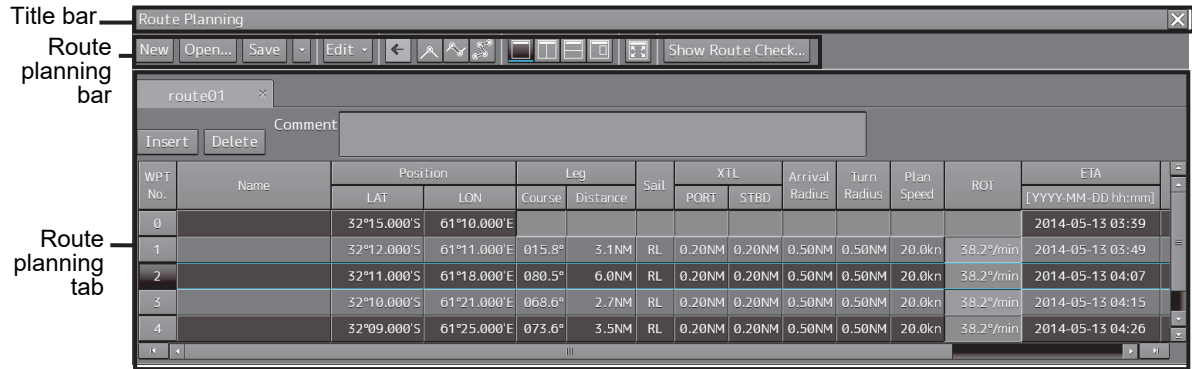

Name	Function
Title bar	Displays the menu title, "Route Planning".
Route Planning bar	Route planning tools are assigned (Refer to "9.4.1 Route Planning bar").
Route planning tab	Displays the file name and route data of the route file that is being created (Refer to "9.4.2 Route planning tab").

9.4.1 Route Planning bar

The Route Planning bar comprises the following tools.

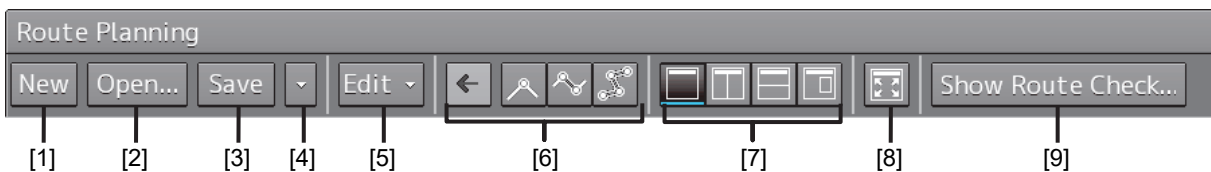

[1] [New] button

When this button is clicked on, a new route planning tab is added to the dialog box, enabling creation of a new route file.

Note

Up to four route files can be opened concurrently. If four files have already been opened, the [New] button is disabled. To create a new route file, close one or more of the files that are opened and click on the [New] button.

[2] [Open...] button

When this button is clicked on, the [File Operations] (Open a file) dialog box appears and a required file can be selected and opened from the route list of the files that have been saved.

Note

Up to four route files can be opened concurrently. If four files have already been opened, the [Open] button is disabled. To open from the saving list, close one or more of the files that are opened and click on the [Open] button.

[3] [Save] button

When the [Save] button is clicked on, the route file is saved.

For the details, refer to "9.5 Saving a Route".

[4] Route planning menu button

When this button is clicked on, the route planning menu is displayed.

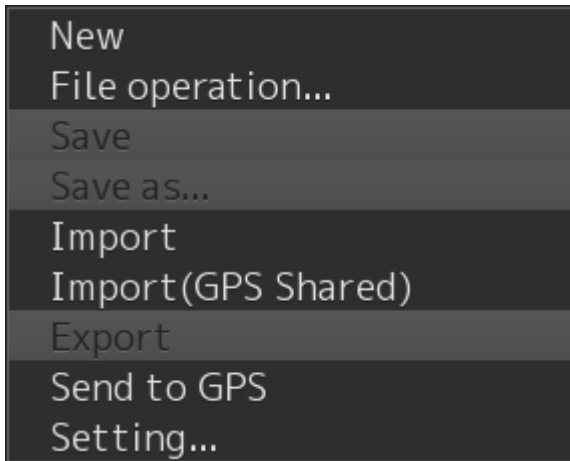

The following operations can be performed by using the route planning menu.

Menu button name	Function	Related section
[New]	Creates a new route file.	9.6.2 Creating a new route file by table editing 9.7.2 Creating a new route file by graphic editing
[File operation...]	Displays the [File operation] dialog box.	9.6.4 Editing a route by table editing
[Save] (overwrite save)	Saves a route file by overwriting.	9.5 Saving a Route
[Save as...]	Saves a route file by naming the file.	9.5 Saving a Route
[Import]	Displays the [Import] dialog box.	9.11.1 Importing a route file
[Import](GPS Shared) (import from GPS)	Displays the [Import(GPS Shared)] dialog box.	Instruction Manual <Function 2>, 1.6 Importing the Route File That Is Received from GPS
[Export]	Displays the [Export] dialog box.	9.11.2 Exporting a route file
Send to GPS (Export for GPS)	Displays the [Send to GPS] dialog.	Instruction Manual <Function 2>, 1.6.1 Transmitting a route file to GPS

Menu button name	Function	Related section
[Setting...]	Displays the [Route] dialog box for setting initial values of the route at route planning.	9.2.2 Setting [Settings] - [Route] on the menu

[5] [Edit] button

When this button is clicked on, the Edit menu is displayed.

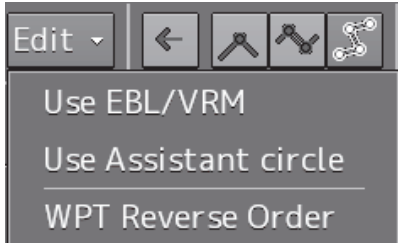

The following operations can be performed by using the Edit menu.

Menu button name	Function	Related section
[Use EBL/VRM]	When this item is selected by clicking on the item, the EBL/VRM mode that enables creation of a route by using EBL and VRM becomes available. When the item is clicked on again, the check mark is cleared and EBL/VRM mode is cancelled.	9.7.2.1 Creating a route by using EBL/VRM
[Use Assistant circle]	When this item is selected by clicking on the item, the Use Assistant circle mode that enables creation of a route by using an assistant circle (supplementary line) becomes available. When the item is clicked on again, the check mark is cleared and the Use Assistance circle mode is cancelled.	9.7.2.2 Creating a route by using the assistant circle function
[WPT Reverse Order]	When this item is selected by clicking on the item, the order of the WPT that is currently selected can be reversed.	-

[6] Display area switching button

Chart display can be changed to the display area/scale suitable for the editing.

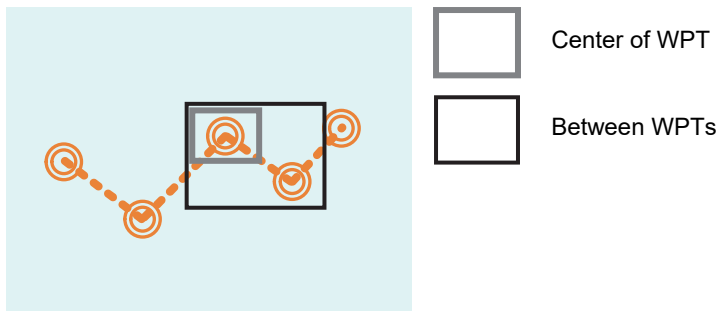
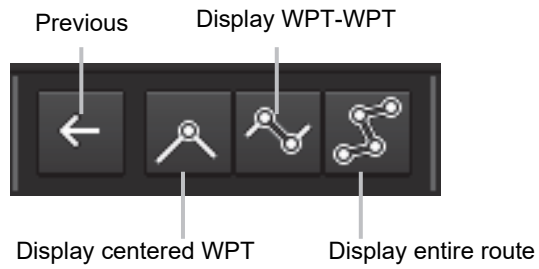

Button name	Function
[Previous]	Switches the chart display to the display area/scale before the chart display was switched.
[Display centered WPT]	Displays the WPT that is currently being edited at the center of the chart.
[Display WPT-WPT]	Displays on the chart the WPT that is currently being edited and the previous WPT.
[Display entire route]	Displays the entire route that is being edited on the chart.

[7] Multi view switching button

A method of splitting a chart can be selected.

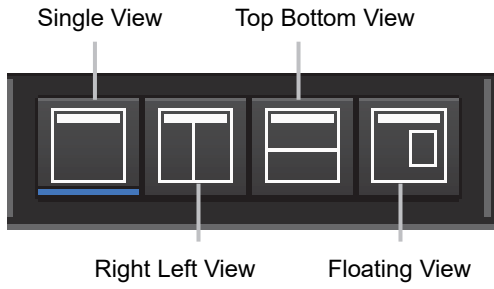

Button name	Function	Display image
[Single View]	Displays a chart on a single screen.	
[Right Left View]	Displays a chart by splitting it into 2 screens of left and right.	
[Top Bottom View]	Displays a chart by splitting it into top and bottom.	
[Picture in Picture] (Dialog view)	Displays a dialog box of another chart inside of the chart screen.	

[8] [Display full] (Full screen display) button

A chart can be displayed in full screen mode by clicking on this button that clears the operation section and display section other than the [Route Planning] dialog box. When this button is clicked on again, the operation section and the display section are re-displayed.

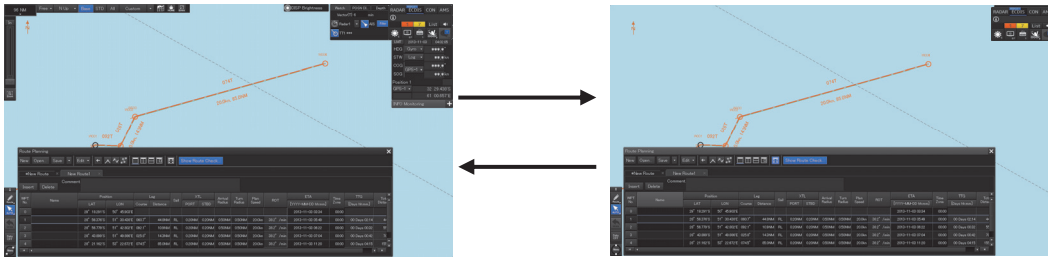

Usual display

Full screen display

[9] [Show Route Check...] (Route check screen display) button

When this button is clicked on, the [Check Route] dialog appears. When an error is detected, the error count is displayed with a badge.



For the details of the [Check Route] dialog, refer to "9.9 Checking Route Data".

9.4.2 Route planning tab

When a route file is opened, a route plan tab comprising a file name display section and route data is displayed. Up to four route planning tabs can be displayed concurrently.

File name display section

The file names that are currently opened are displayed in the tabs. When the display of the file name is clicked on, the route file can be switched.

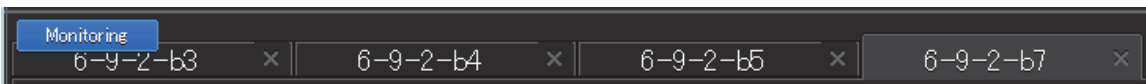

"*" is attached to the top of the name of the file you are editing.

A badge is displayed on the name of the file that is being monitored or under automatic sailing.



Monitoring badge

Automatic sailing badge

When the [X] button on the file name display section is clicked on, the tab is closed. If an attempt is made to close the tab that has not been saved, a save confirmation message dialog box appears.

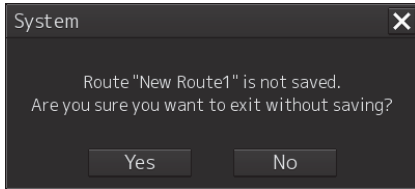

To close the tab by saving the route file by overwriting, click on the [Yes] button. When not saving the route file by overwriting, click on the [No] button. When the [X] button is clicked on, the file returns to the state prior to the clicking on the [X] button on the file name display section.

Route data

WPTs that form the route and the WPT data are displayed in a list.

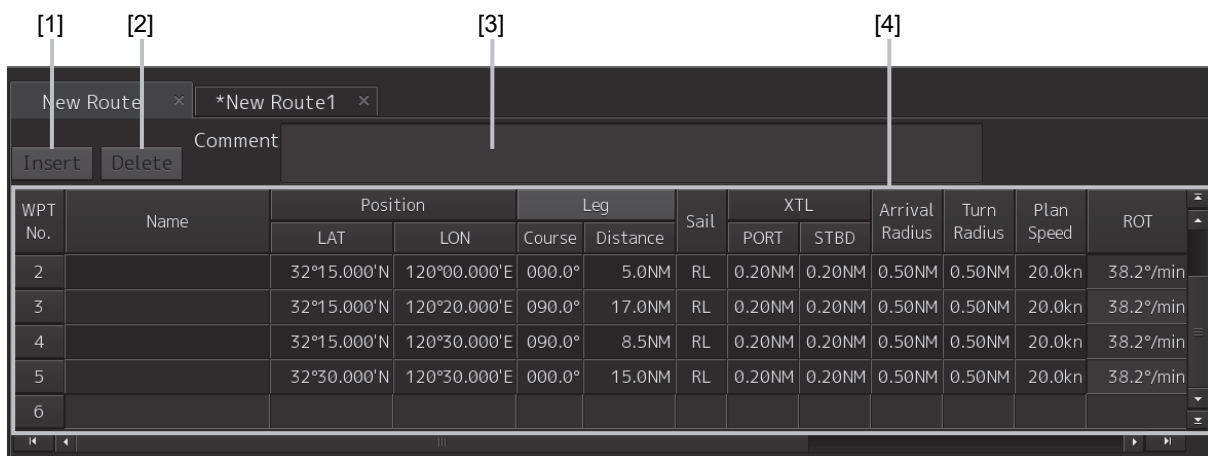

Route Data

[1] [Insert] button

A new WPT is inserted in the selected WPT.

[2] [Delete] button

The selected WPT is deleted.

[3] [Comment] field

The comment of the route file is displayed.

[4] WPT list

Data of each WPT is displayed.

9.5 Saving a Route

- 1 Click on the [Save] button on the Route Planning bar.

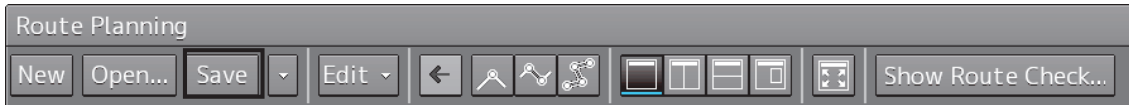

Or select the [Save] button that is displayed by clicking on the Route Planning menu button

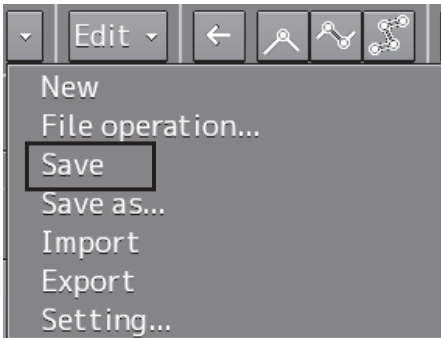

At creation of a new route, a [Save as Route File] dialog box appears.

Perform Steps 2 to 4 in the [Save as Route File] dialog.

When the existing route file is saved, the [Save as Route File] dialog box does not appear since the file is overwritten.

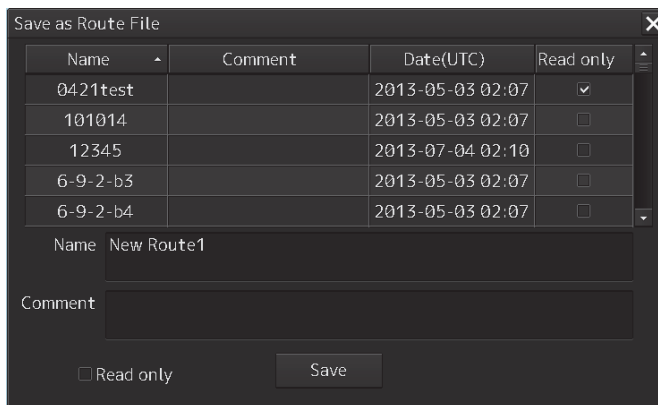

- 2 Enter [Name] and a comment in [Comment] as required.

Note

Although up to 64 characters are allowed for a route name, only 8 characters are output when the information is transmitted to another equipment as the route information (RTE sentence).

Memo

When all the files that have been saved are opened, all the file names may not necessarily be displayed. Files can be distinguished easily by entering comments.

-
- 3** Click on the [Save] button.

The file is saved.

- 4** The file name that is displayed on the Route Planning tab changes to the name that is specified in the [Name] box.

For the details of the Route Planning tab, refer to "9.4.2 Route planning tab".

When a route of the same file name already exists

- 1** When file saving operation is performed, a dialog box message appears confirming whether the file is to be overwritten.

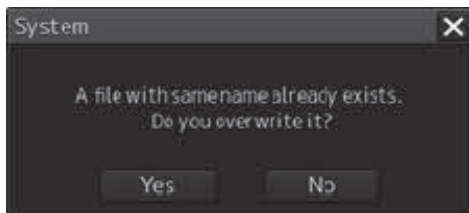

- 2** When overwriting the file, save the file by clicking on the [Yes] button. When not overwriting the file, close the dialog box by clicking on the [No] button and change the file name on the [Save as Route File] dialog box.

Memo

- The following message is displayed when an attempt is made to overwrite a protected file.

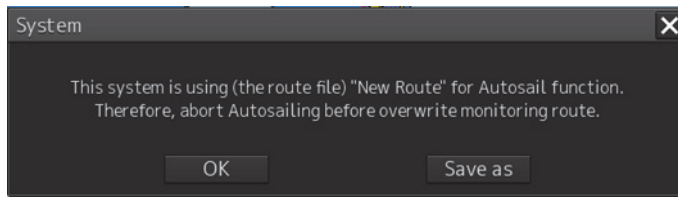

To cancel the save operation, close the dialog box by clicking on the [OK] button or the [X] button. When saving the file by changing the file name, click on the [Save as...] button. The dialog box is closed and the [Save as Route File] dialog box appears.

- The following message is displayed when an attempt is made to overwrite the route file that is currently being monitored.

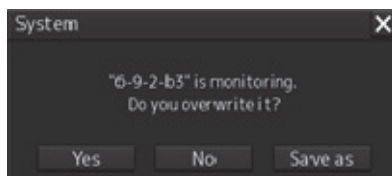

To cancel the save operation, click on the [No] button or [X] button. To continue the monitoring of the updated route by saving the route file by overwriting, click on the [Yes] button. When saving the file by changing the file name, click on the [Save as...] button. The dialog box is closed and the [Save as Route File] dialog box appears.

- The following message is displayed when an attempt is made to overwrite the file of the route under automatic sailing.

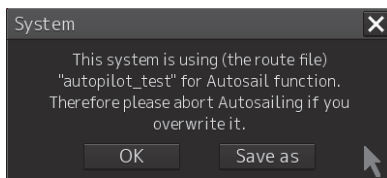

To cancel the save operation, close the dialog box by clicking on the [OK] button or the [X] button. When saving the file by changing the file name, click on the [Save as...] button. The dialog box is closed and the [Save as Route File] dialog box appears.

The monitored route does not change by the save operation. Automatic sailing continues based on the pre-saved route.

Note

When editing the file of the route being monitored, if the limit check detects a turning radius error ("The straight route can not be created."), The following popup will be displayed when saving.

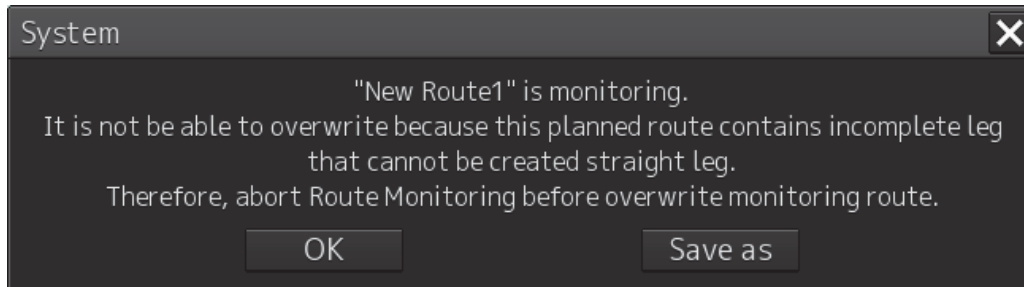

To cancel the save operation, close the dialog box by clicking on the [OK] button or the [X] button. When saving the file by changing the file name, click on the [Save as...] button. The dialog box is closed and the [Save as Route File] dialog box appears.

Saving a route file by naming the file

Click on [Save as...] of the route planning menu button on the Route Planning bar.

When the [Save as Route File] dialog box appears, save the file by entering a new file name.

Setting a route file to a Read Only mode (disabling editing)

Check Read only for the file that is to be set to [Read only] (disabling editing) mode. To cancel Read Only (disabling editing) specification, clear the check.

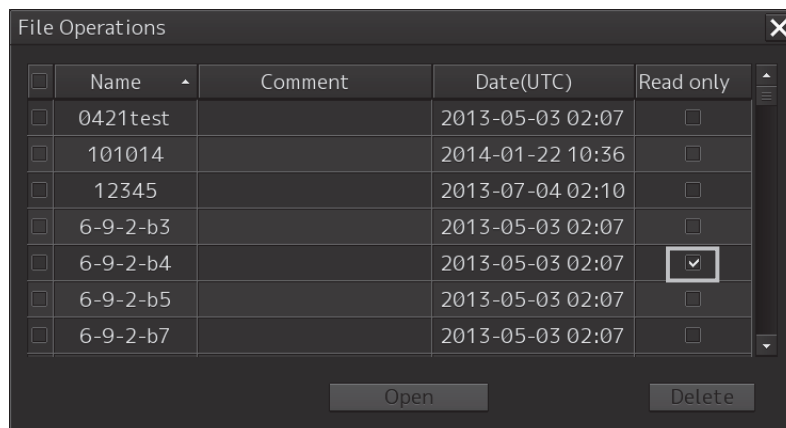

9.6 Planning a Route by Using Table Editing

CAUTION



Edit the navigation route according to the world geodetic system (WGS-84).
If you use the navigation route edited by a geodetic system other than the world geodetic system, an accident may occur.

9.6.1 Table editing operation flow

9

9.6.1.1 Creating a new route file

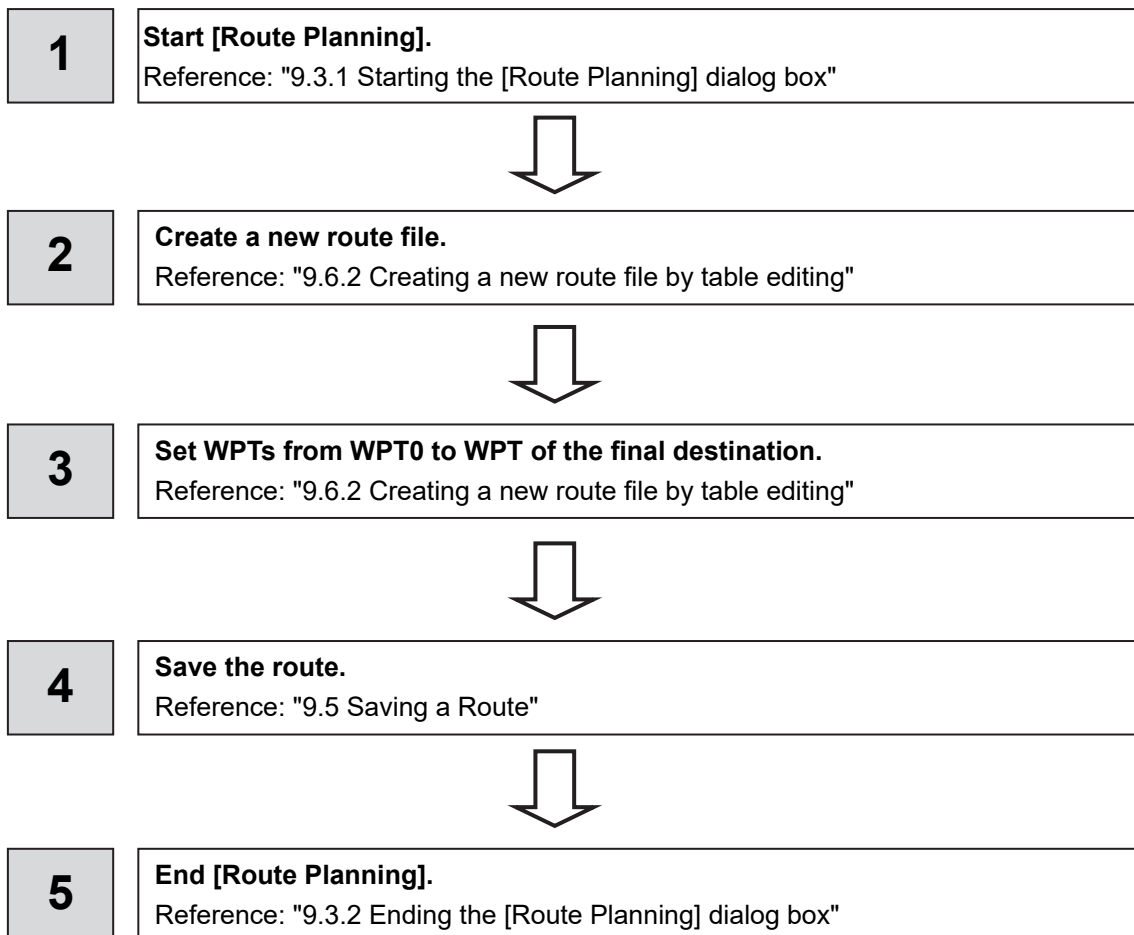

9.6.1.2 Editing a route

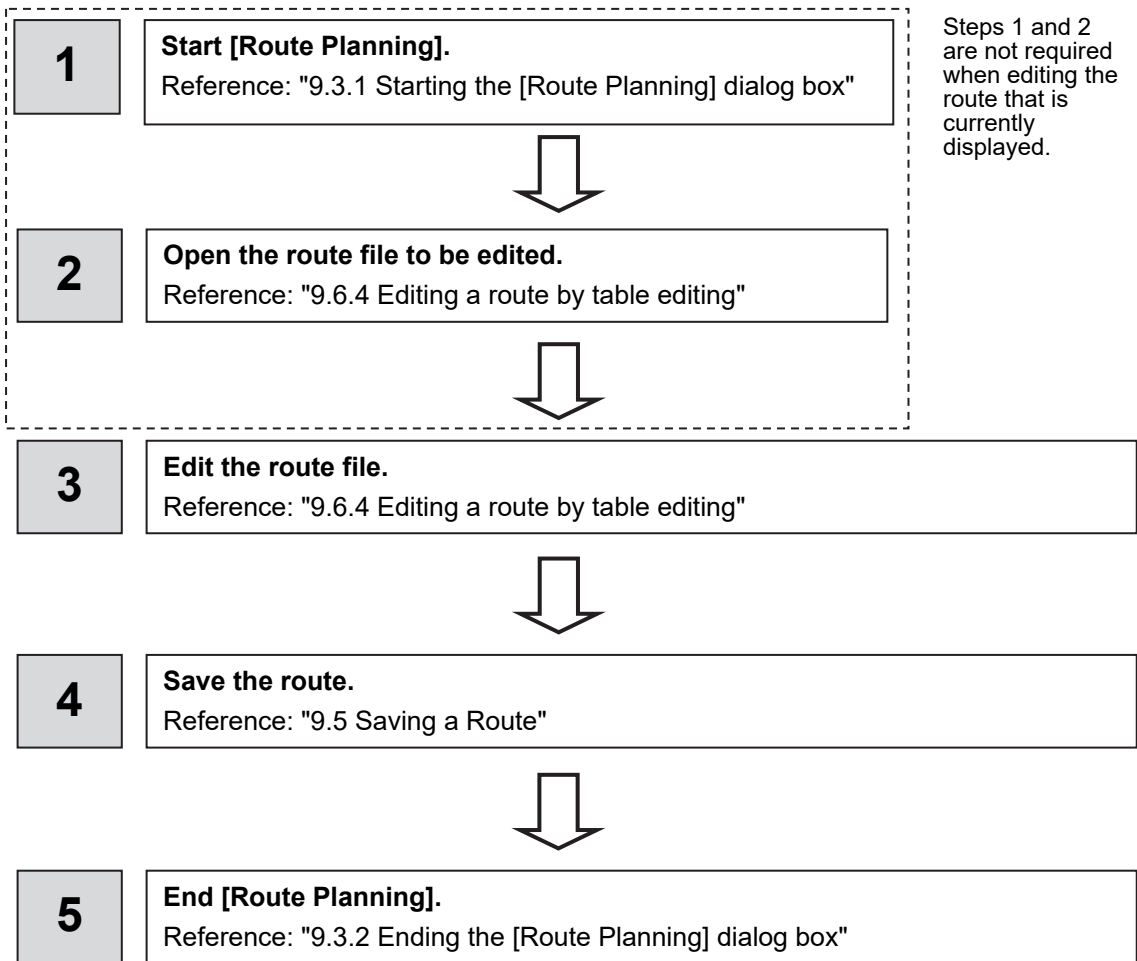

9.6.2 Creating a new route file by table editing

- 1 Click on the [New] button on the Route Planning bar



Or select the [New] button that is displayed by clicking on the Route Planning menu button.

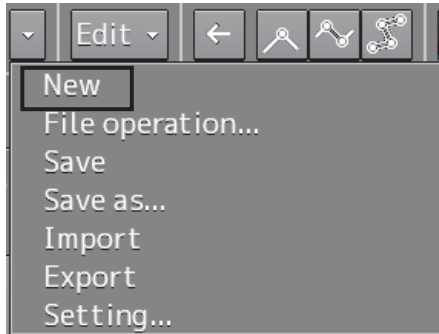

A new tab is added.

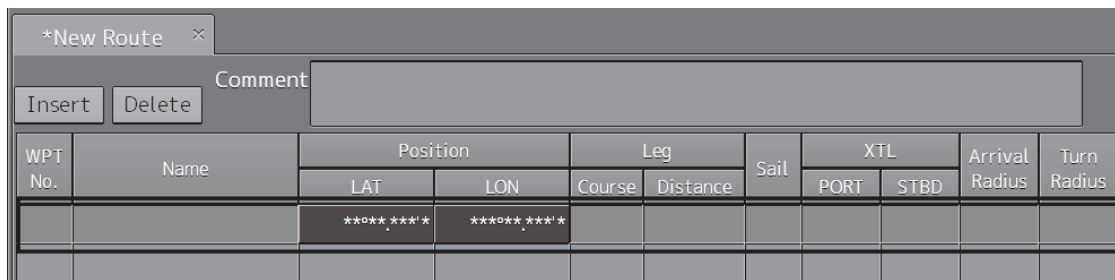

- 2 Enter the latitude and the longitude of WPT0 (waypoint 0)

Enter the latitude by clicking on [LAT] of [Position].

Enter the longitude by clicking on [LON] of [Position].

Use the software keyboard for entering the latitude and longitude.

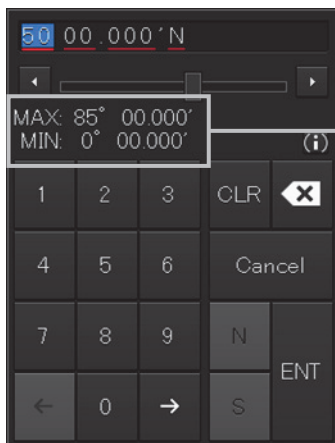

Latitude software keyboard

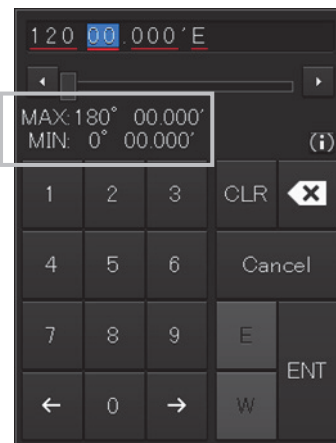

Longitude software keyboard

Range of the values that can be entered

Memo

The maximum latitude input range of Position is 85 ° 00.000 (polar range restriction).

3 Set the following items as required.

*Some items are for display only and cannot be set.

Item	Description
[Name]	Set a name of WPT.
[Leg BWV]	This is the bearing from the previous WPT and is not set in WPT0. The specifiable range is from 0.0° to 359.9°. Editing is disabled when [GC] is selected in [Sail].
[Leg Distance]	This is the distance from the previous WPT and is not set in WPT0. The specifiable range is from 0.0 to 9999.9 NM. Editing is disabled when [GC] is selected in [Sail].
[Sail]	[RL] or [GC] can be selected from the list.
[XTD PORT] (Port side cross track limit)	Set a port side cross track limit. The specifiable range is from 0.01 to 9.99 NM.
[XTD STBD] (Starboard side cross track limit)	Set a starboard side cross track limit. The specifiable range is from 0.01 to 9.99 NM.
[Arrival Radius]	Sets the arrival radius. (0.01 to 9.99 NM)
[Turning Radius] (Turning radius)	Sets the turning radius. (0.00 to 9.99 NM)
[Planned Speed] (Planned speed)	Sets the planned ship's speed. (1.0 to 99.9kn)
[ROT]	ROT is automatically calculated from the planned speed and turning radius.
[ETA]	ETA is automatically calculated from the position of WPT, planned speed, and time zone.
[Time Zone]	The time difference of the time of arrival can be input within the range from -13.30 to +13.30.
[TWOL]	TTG can be automatically calculated from the position of WPT and planned speed. ※[Setting]-[Route]-[Monitoring]-[Arrivalcircle] selected:[TTG]
[Total Distance]	This is the total distance between WPT0 and the final WPT.

Memo

The values that are set by selecting [Settings] – [Route] on the menu is reflected in [Sail], [XTD PORT], [XTD STBD], [Arrival radius], [Turning Radius], [Planned Speed], and [Time Zone]. For the details, refer to "18.12 Setting parameter values for automatic sailing".

- 4 Add the next WPT by clicking on the next WPT No. or the [Insert] button after entering the latitude and longitude.

WPT No.	Name	Position		Leg	
		LAT	LON	Course	Distance
0		32°00.000'N	120°00.000'E		
1					

WPT1 is added.

- 5 Set the item as indicated in Step 3.
- 6 Enter data up to the last WPT with the same procedure.
The route based on the input data is displayed each time.

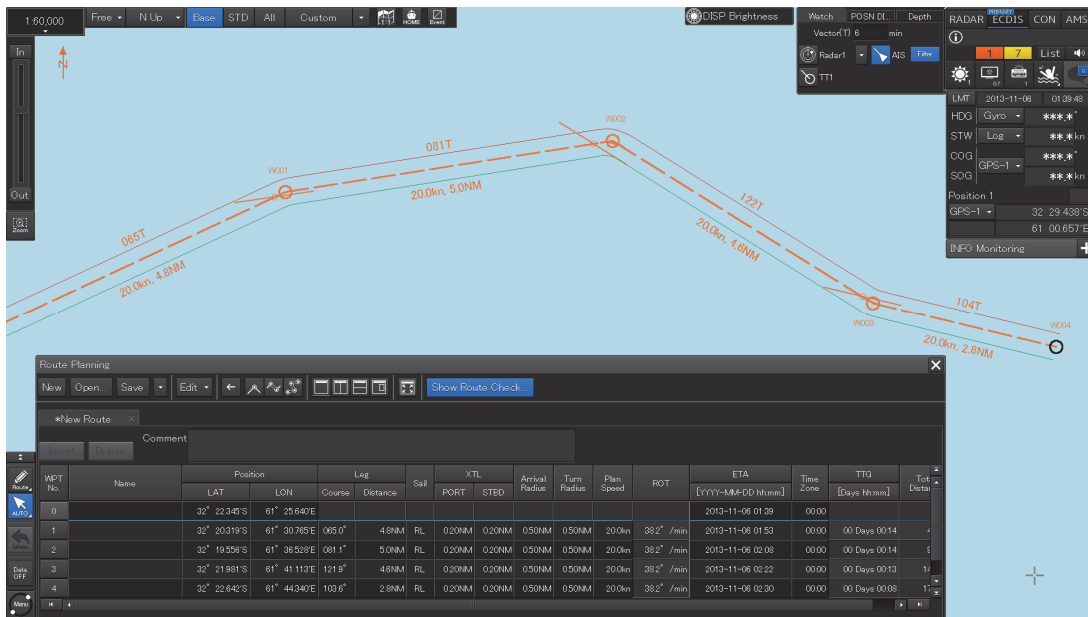

- 7 After completing the creation, save the route file.
For the saving procedure, refer to "9.5 Saving a Route".

9.6.3 Deleting WPT data

- 1 Select WPT data to be deleted and click on the [Delete] button.

9.6.4 Editing a route by table editing

Memo

Steps 1 and 2 are not required when editing the route that is currently displayed.

- 1 Click on the [Open] button on the Route Planning bar

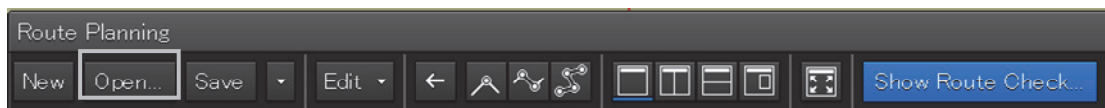

Or select the [File operation...] button that is displayed by clicking on the Route Planning menu button.

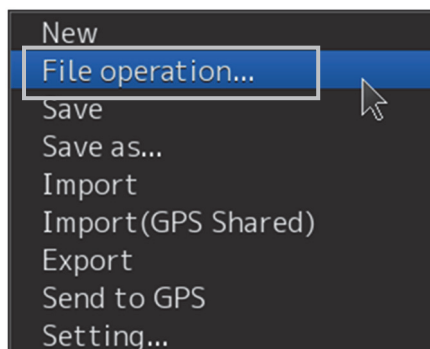

The [File operation...] dialog box appears.

- 2 Select the route file to be edited and click on the [Open] button.

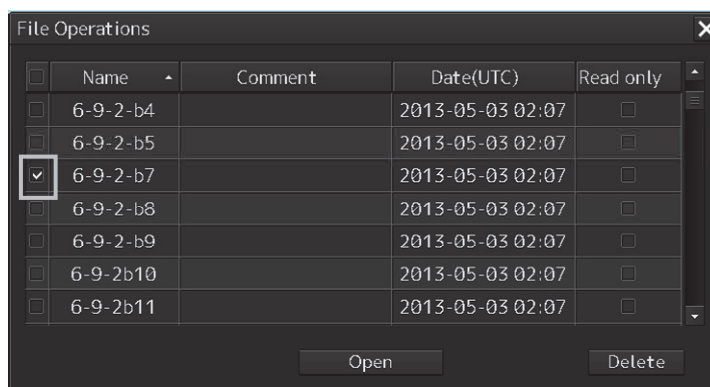

Memo

If [Read only] is selected, the file overwrite function is disabled. To overwrite the existing file, clear the item before opening the file.

The route file is displayed on the [Route Planning] dialog box.

WPT No.	Name	Position		Leg		Sail	XTL		Arrival Radius	Turn Radius	Plan Speed	ROT
		LAT	LON	Course	Distance		PORT	STBD				
0		38°50.560'N	141°40.000'E									
1		38°50.400'N	141°40.500'E	112.3°	0.4NM	RL	0.20NM	0.20NM	0.50NM	0.50NM	20.0kn	30.0°/min
2		38°50.400'N	141°41.500'E	090.0°	0.8NM	RL	0.20NM	0.20NM	0.50NM	0.50NM	20.0kn	30.0°/min
3												

For the details of the Route Planning tab, refer to "9.4.2 Route planning tab".

3 Select WPT No. of WPT to be changed and click the right mouse button.

The context menu is displayed.

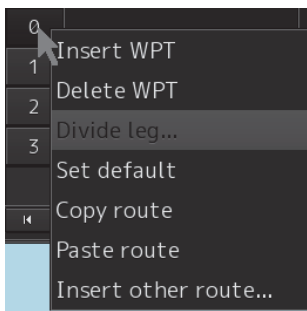

WPT0 is selected

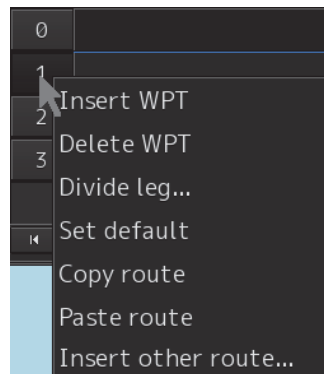

WPT0 is selected and WPT is other than the last WPT

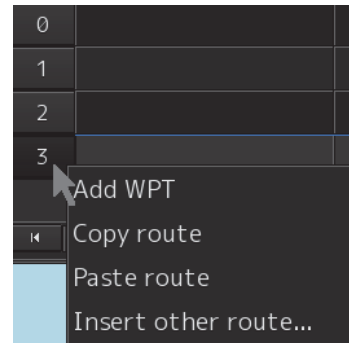

The last WPT is selected

A route can be edited by selecting the "Edit" mode from the context menu.

The procedures for editing are as follows.

Menu button name	Function	Related section
Insert WPT	Adds WPT.	9.6.4.1 Route Planning bar
Delete WPT	Deletes WPT.	9.6.4.2 Deleting WPT
Divide leg...	Displays a leg division dialog box. Divides the leg in the dialog box.	9.6.4.3 Dividing a leg
Set default	Reflects the initial value of the route plan setting in the specified WPT.	-
Copy route	Copies the entire route.	9.6.4.4 Copying the entire route
Paste route	Pastes the copied course to the last WPT of the course.	9.6.4.5 Pasting the copied route
Insert other route	Displays the insertion dialog of some other route. Inserts some other dialog in the route that is being edited on the dialog.	9.6.4.6 Inserting the other route
Add WPT	Inserts the WPT of the same value as the last WPT.	9.6.4.7 Insert the same WPT as the last WPT

4 After completing the editing, click on the [Save] button on the Route Planning bar.

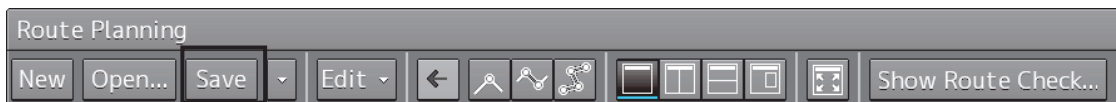

Or select the [Save] button that is displayed by clicking on the Route Planning menu button

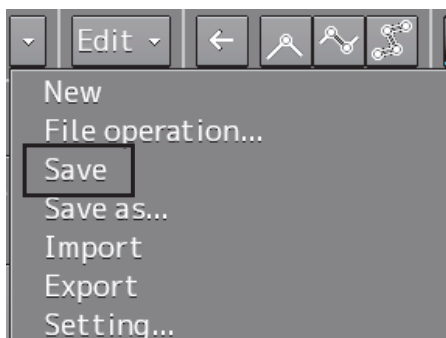

For the details of save operation, refer to "9.5 Saving a Route ".

9.6.4.1 Inserting WPT

Insert the WPT of the same value as the selected WPT.

- 1 Click the right mouse button on the WPT No. of the WPT to be inserted.**
The context menu is displayed.
- 2 Click on [Insert WPT] of the context menu.**
WPT is inserted following the selected WPT.

9.6.4.2 Deleting WPT

Delete the selected WPT.

- 1 Click the right mouse button on the WPT No. of the WPT to be deleted.**
The context menu is displayed.
- 2 Click on [Delete WPT] on the context menu.**
The selected WPT is deleted.

9.6.4.3 Dividing a leg

A leg can be divided by setting a longitude or a nautical mile.

- 1 Click the right button on the WPT No. to be divided.**

The context menu is displayed.

- 2 Click on [Divide leg...] of the context menu.**

The [Divide Route] dialog box appears.

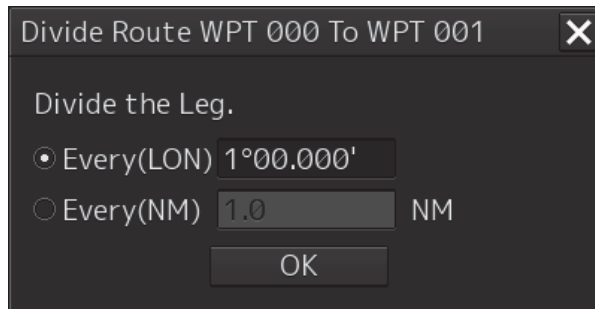

- 3 Enter a division interval.**

[Every (LON)] (Longitude division)

- 1) Click on "Every(LON)".
- 2) Enter a longitude interval for division.

[Every(NM)] (Nautical mile division)

- 1) Click on "Every(NM)".
- 2) Enter a nautical mile interval for division.

- 4 Click on the [OK] button.**

The leg that is selected in Step 1 is divided in the unit that is specified in Step 3.

Note

When the total number of WPTs exceeds the maximum value of 511 as a result of leg division, leg division is executed within the range of 511 in the entire route.

9.6.4.4 Copying the entire route

Copy the entire route that is selected.

- 1 Click the right mouse button on the WPT No. other than the last WPT.**

The context menu is displayed.

- 2 Click on [Copy route] on the context menu.**

The entire route is copied.

9.6.4.5 Pasting the copied route

The route that was copied to the last WEP of the route is pasted.

- 1 Click the right mouse button on the WPT No. of the WPT on which the route is to be pasted.**

The context menu is displayed.

- 2 Click on [Paste route] in the context menu.**

The routes are pasted (inserted)

Note

After pasting the copied route, when a route planning error occurs as a result of recalculation of the BWW, Distance, Total Distance, ROT, TWOL, and ETA, an error message is displayed and the route will not be pasted.

Memo

The same operation is performed also when the next No. button of the last WPT is clicked.

9.6.4.6 Inserting the other route

Insert the route of some other file in the route that is being edited.

- 1 Click the right mouse button on WPT No.**

A context menu is displayed.

- 2 Click on [Insert other route] in the context menu.**

The [Insert other route] dialog box appears.

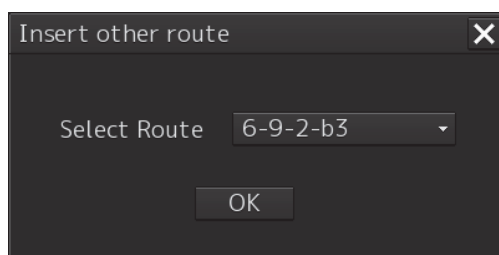

- 3 Select a route file to be inserted from the [Select Route] combo box.**

- 4 Click on the [OK] button.**

The route file is inserted.

Note

If the range can be inserted is exceeded, an error message is displayed and the route will not be inserted.

9.6.4.7 Insert the same WPT as the last WPT

Insert the same WPT as the last WPT following the last WPT.

- 1 Click the right mouse button on the WPT No. of the last WPT.**
The context menu is displayed.
- 2 Click on [Add WPT] on the context menu.**
WPT is added following the last WPT.

9.7 Planning a New Route by Graphic Editing

CAUTION



Edit the navigation route according to the world geodetic system (WGS-84).
If you use the navigation route edited by a geodetic system other than the world geodetic system, an accident may occur.

9.7.1 Graphic editing operation flow

9

9.7.1.1 Creating a new route file

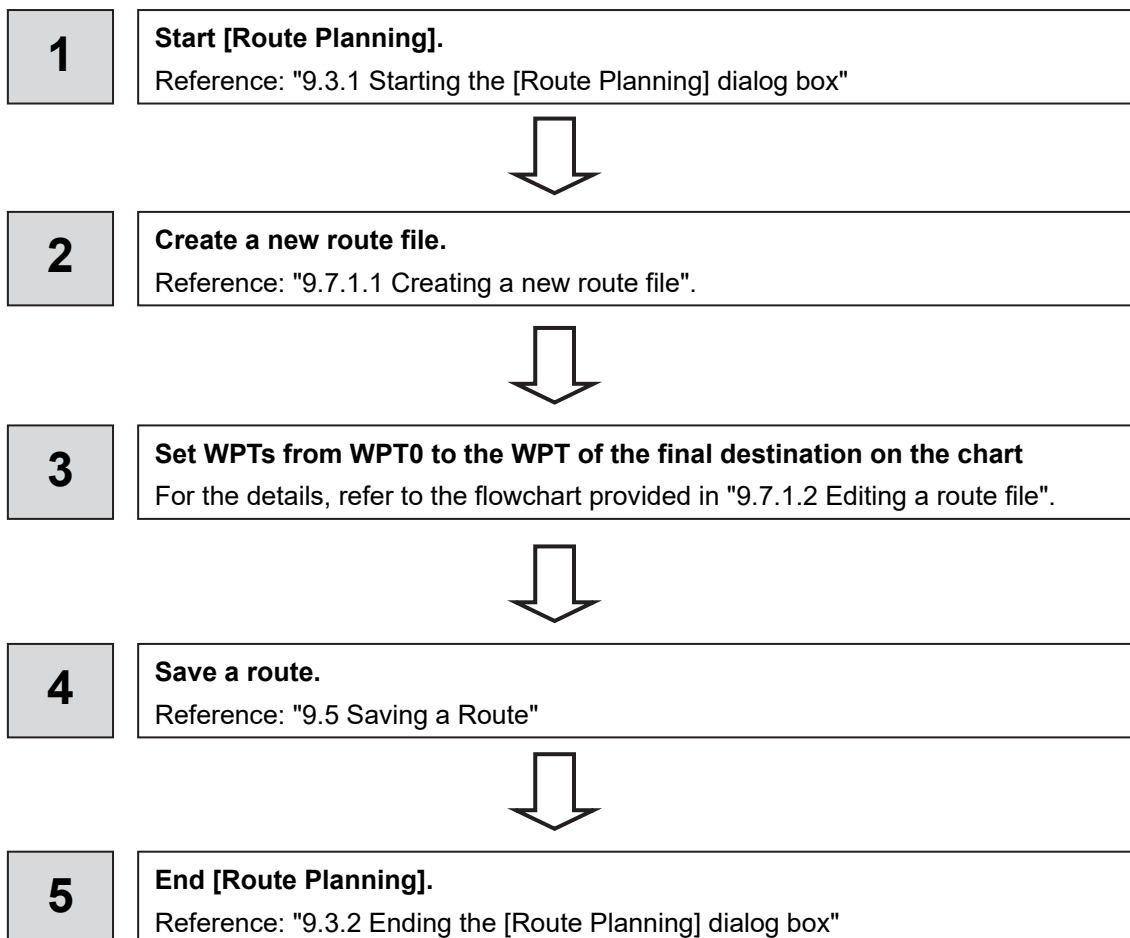

9.7.1.2 Editing a route file

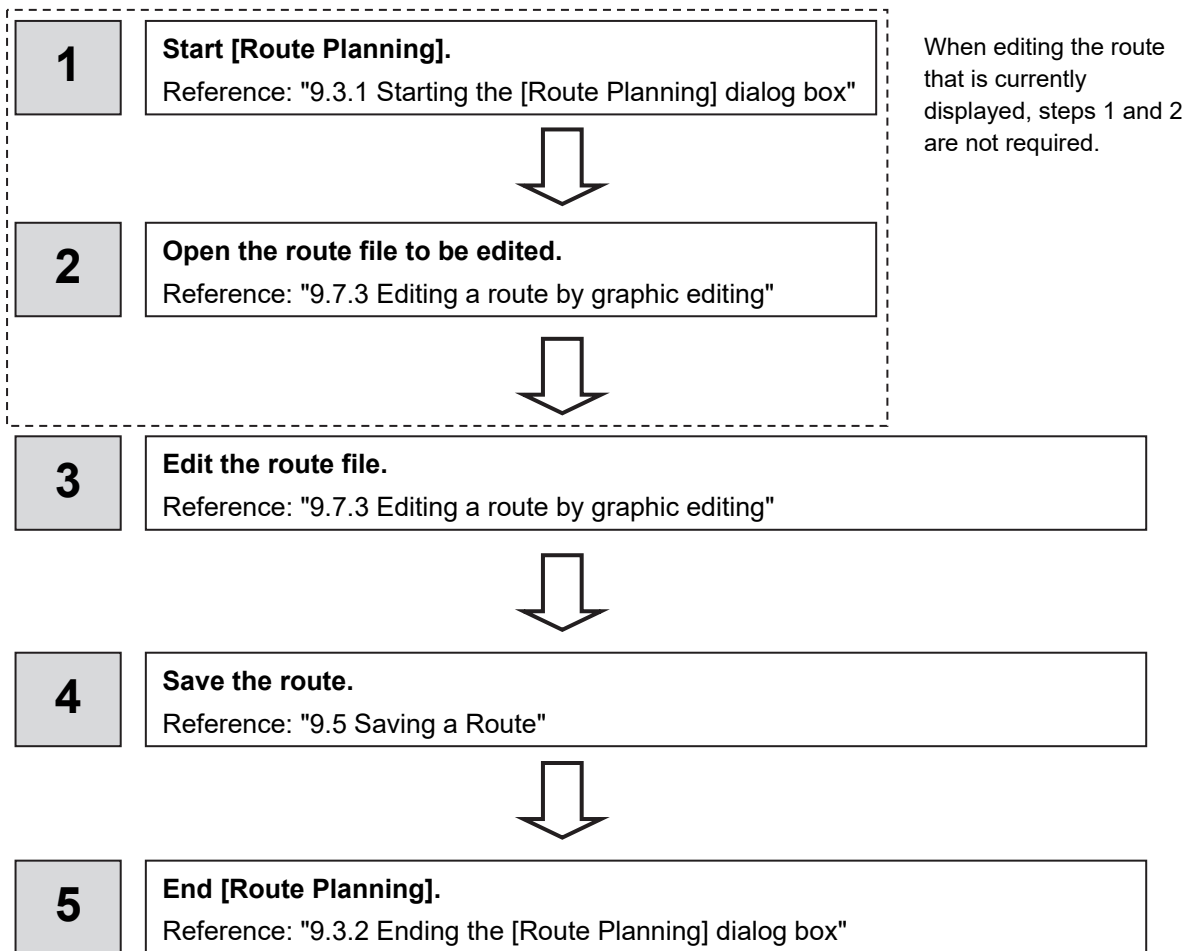

9.7.2 Creating a new route file by graphic editing

- 1 Click on the [New] button on the Route Planning bar.

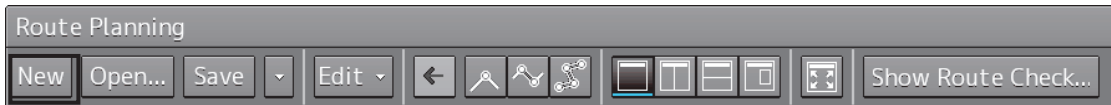

Or select the [New] button on the menu that is displayed by clicking on the Route Planning menu button.

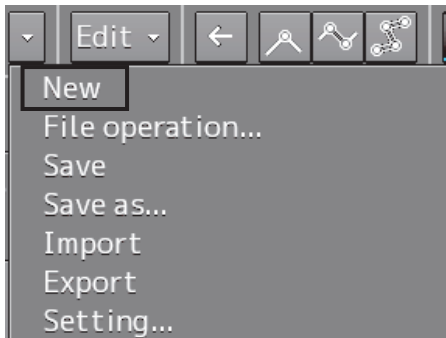

- 2 Placing the cursor on the WPT0 position.

The latitude and the longitude of the WPT are displayed near the cursor.



- 3 Click the mouse button.

WPT0 is added.

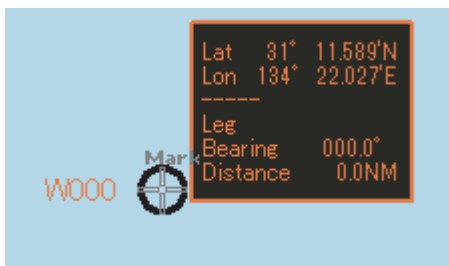

4 Move the cursor.

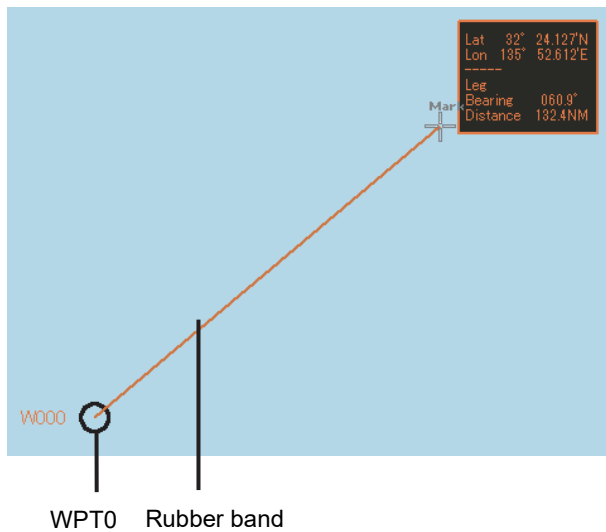

5 Click the mouse button.

WPT1 is added at the cursor position.

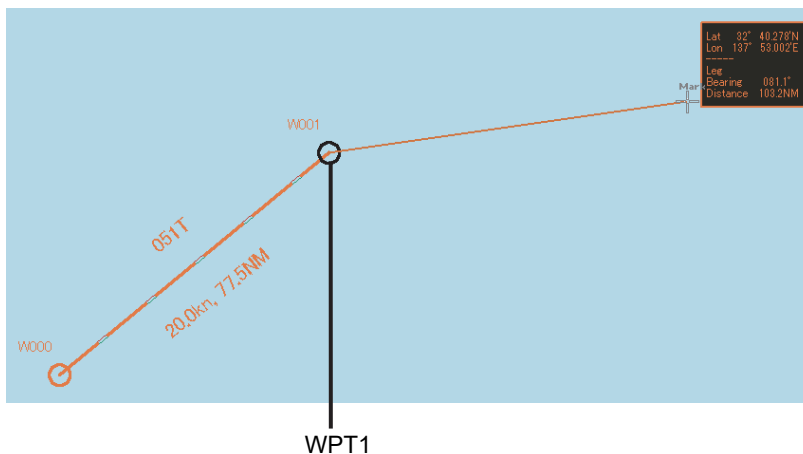

6 Add as many WPTs as required in the same way.

7 After creating the last WPT, double-click the left button or click the right button.

The Route planning is terminated.

Note

In the case of ARCS, when a WPT is specified at a position other than the active chart and another panel exists at the position, the panel display is switched automatically.

8 Save the route file that was created.

For the details of how to save the file, refer to "9.5 Saving a Route".

9.7.2.1 Creating a route by using EBL/VRM

- 1 Click on [Use EBL/VRM] on the [Edit] button to select it.

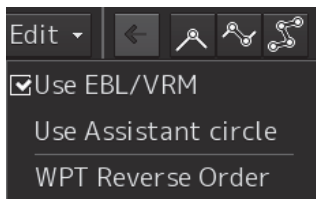

The cursor changes to EBL/VRM.

- 2 Move the cursor to the position used as the mark (example: headland) and click on the position.



- 3 Move the cursor and determine the WPT position while checking the bearing from the position used as the mark.

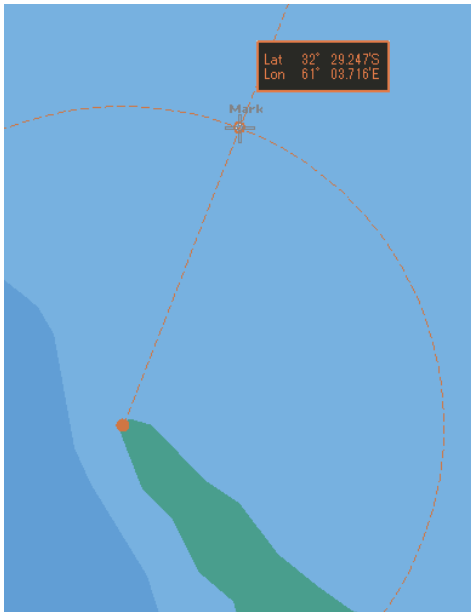

The latitude/longitude is displayed next to the cursor.

- 4 Click the mouse button.



WPT0 is created.

- 5 Add as many WPTs as required in the same way.

Memo

When EBL/VRM is not used for creation of the next WPT, clear the item by clicking on [Use EBL/VRM].

-
-
- 6 After creating the last WPT, double click the left button or click the right button.**
The Route planning is terminated.

9.7.2.2 Creating a route by using the assistant circle function

A route can be created by using an assistant circle (supplementary line).

The assistant circle function adds WPT at the position where the mark such as headland and the leg intersects at right angles.

When the position that is used as the mark is determined and the cursor is moved to the position, WPT is added at the position where the leg and the position intersect at right angles.

- 1 Select the [Use Assistant circle] check box of the [Edit] button.**

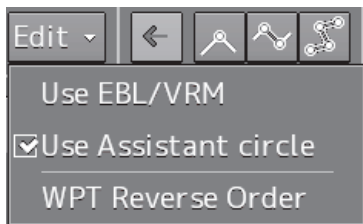

- 2 Move the cursor to any position and click the left button.**

WPT0 is created.

- 3 Move the cursor to the position as the mark (example, headland) and click the button.**

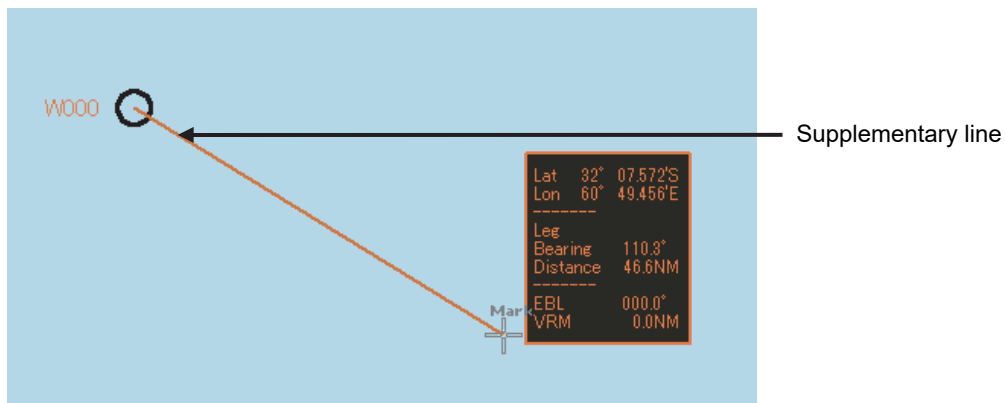

4 Move the cursor and click the button while checking the leg bearing.

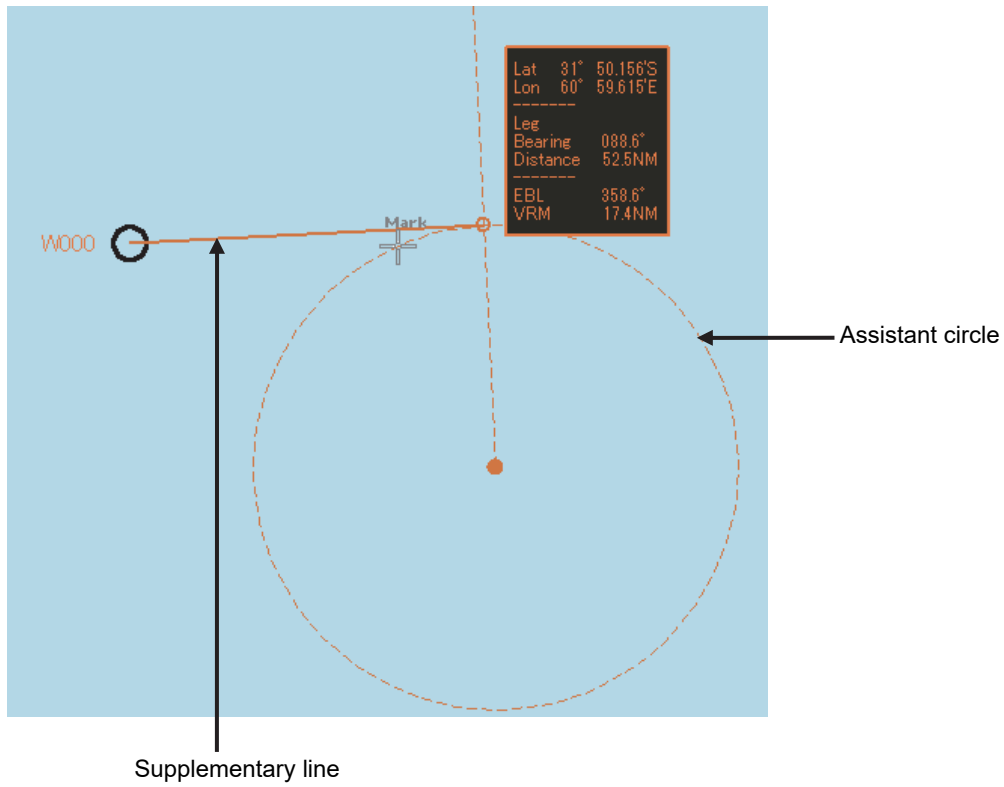

WPT1 is created at the intersecting point of the assistant circle and the supplementary line.

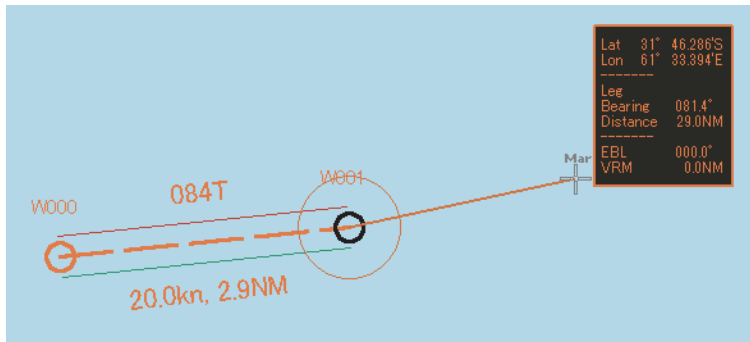

Memo

The direction of the leg varies according to the positional relationship of the cursor.

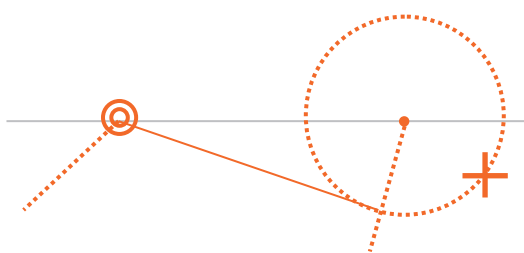

When the cursor is on the right side of the position of WPT and the position used as the mark, the leg will be on the lower side.

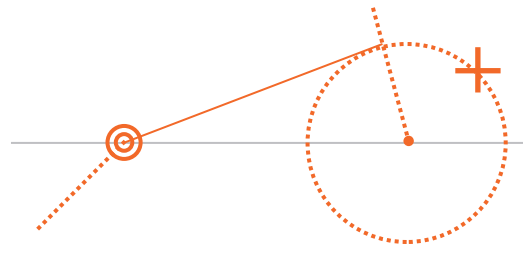

When the cursor is on the left side of the position of WPT and the position used as the mark, the leg will be on the upper side.

5 Add as many WPTs as required in the same way.

Memo
When Use Assistant circle is not used for creation of the next WPT, clear the item by clicking on [Use Assistant circle].

6 After creating the last WPT, double click the left button or click the right button. The Route planning is terminated.

9.7.3 Editing a route by graphic editing

1 Click on the [Open] button on the Route Planning bar.



Or select the [File operation...] button that is displayed by clicking on the Route Planning menu button.

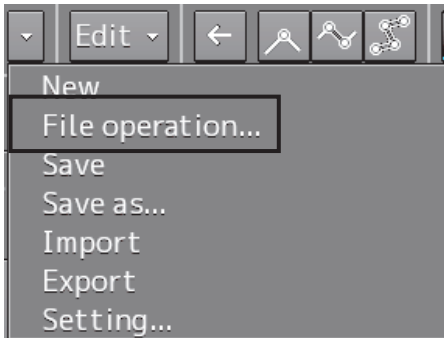

The [File operation...] dialog box appears.

2 Select the route file to be edited and click on the [Open] button.

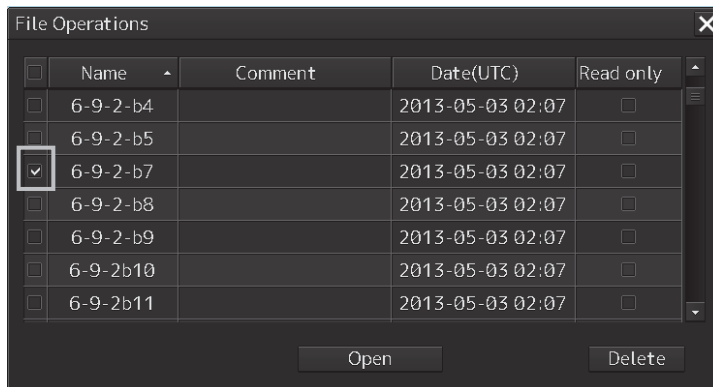

Memo
If [Read only] is selected, the file overwrite function is disabled. To overwrite the existing file, clear the item before opening the file.

3 Edit the route with graphic editing.

Refer to the following for the editing methods.

Editing operations that are allowed by clicking on WPT or a leg of the route.

Editing function	Related section
Inserting WPT between WPTs	9.7.3.1 Inserting a WPT between WPTs
Moving WPT	9.7.3.2 Moving a WPT
Changing XTD (cross track limit)	9.7.3.3 Changing XTD (cross track limit)

Operations that are allowed on the context menu that is displayed by clicking the right mouse button on WPT or a leg of the route

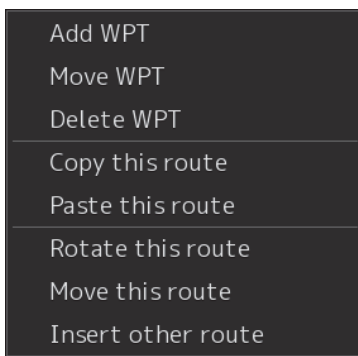

WPT0 or the last WPT is selected

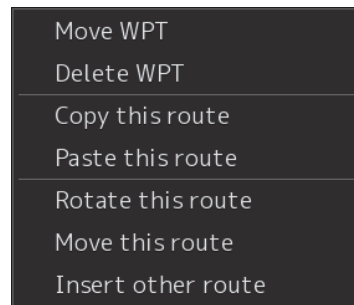

WPT other than WPT0 and the last WPT is selected

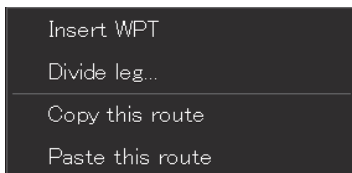

A leg is selected

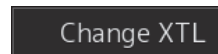

XTD is selected

Menu	Function	Related section
Add WPT	Adds WPT.	9.7.3.4 Adding WPT on the context menu
Move WPT	Moves WPT.	9.7.3.5 Moving WPT on the context menu
Delete WPT	Deletes WPT.	9.7.3.6 Deleting WPT on the context menu
Copy this route	Copies the entire route.	9.7.3.7 Copying and pasting a route on the context menu
Paste this route	Pastes the copied route on to another route file.	
Rotate this route	Rotates the route.	9.7.3.8 Rotating a route on the context menu
Move this route	Moves the route.	9.7.3.9 Moving a route on the context menu
Insert other route	Inserts another dialog into the route that is being edited.	9.7.3.10 Inserting other route on the context menu
Insert WPT	Inserts WPT between WPTs.	9.7.3.11 Inserting WPT between WPTs on the context menu
Divide leg...	Displays a leg division dialog. Divides the leg in the dialog.	9.7.3.12 Dividing a leg on the context menu
Change XTD	Changes the XTD (cross track limit).	9.7.3.13 Changing XTD (cross track limit) on the context menu

4 After completing editing, save the route file.

For the details of how to save the file, refer to "9.5 Saving a Route".

9.7.3.1 Inserting a WPT between WPTs

1 Click the left button on the leg between the WPTs in which a WPT is to be inserted.

The leg is set to a selected state.

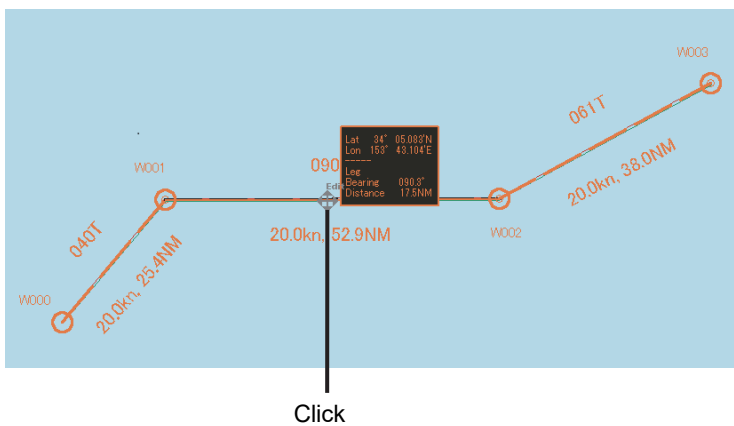

2 Determine the WPT insertion position by moving the cursor.

A rubber band is displayed.

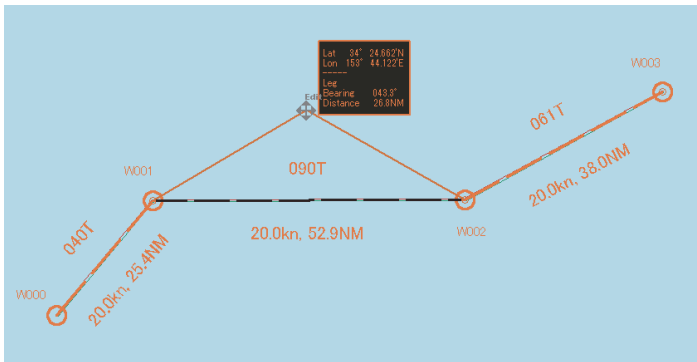

3 Click the mouse button.

A WPT is added.

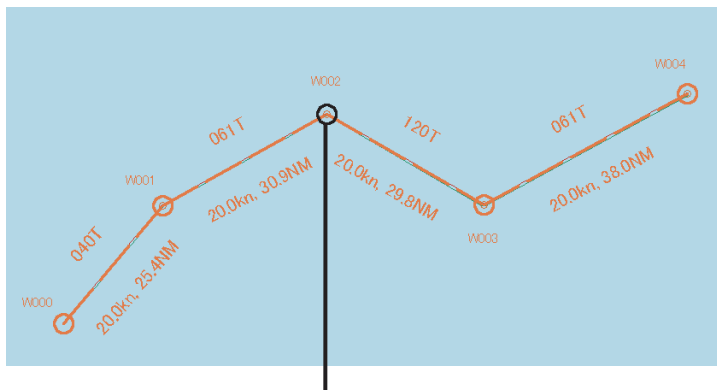

WPT that was added

Cancelling the operation

The addition operation can be cancelled by clicking the right button instead of clicking at Step 3.

9.7.3.2 Moving a WPT

1 Click on the WPT to be moved.

The WPT is set to a selected state.

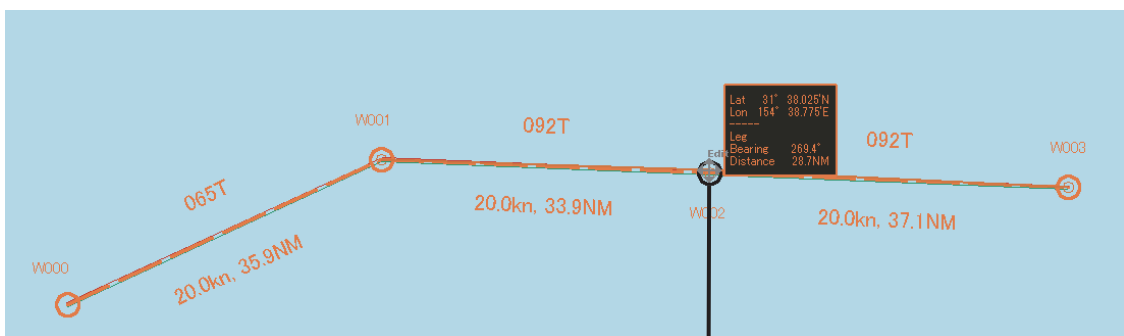

Click.

2 Move the WPT to any position.

A rubber band covering from the WPTs at the front and back to the cursor is displayed.

*In the case of WPT0 or the last WPT, a rubber band is displayed from one side.

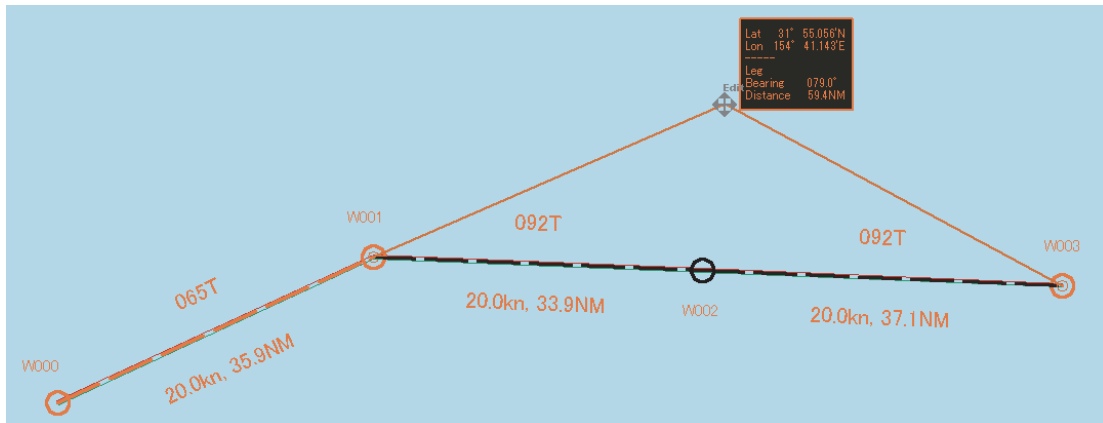

9

3 Click the mouse button.

The move is determined.



Cancelling the operation

The move operation can be cancelled by clicking the right button instead of clicking at Step 3.

9.7.3.3 Changing XTD (cross track limit)

1 Click on the XTD.

The cursor is changed to the XTD change mode.

2 Move the cursor and change the XTD.

Use the information (XTD distance) that is displayed near the cursor and the line that is linked to the cursor as the guideline.



Note

The line cannot be moved exceeding the limit of XTD (5.00 NM).

3 Click the mouse button.

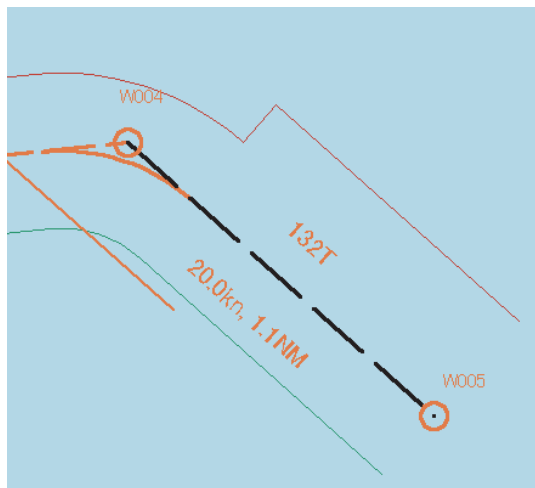

The width of the XTD is changed.

Cancelling the operation

The change operation can be cancelled by clicking the right button instead of clicking at Step 3.

9.7.3.4 Adding WPT on the context menu

Add a WPT to WPT0 or the last WPT.

- 1 Click the right mouse button on WPT0 or the last WPT.**
The context menu is displayed.
- 2 Click [Add WPT] on the context menu.**

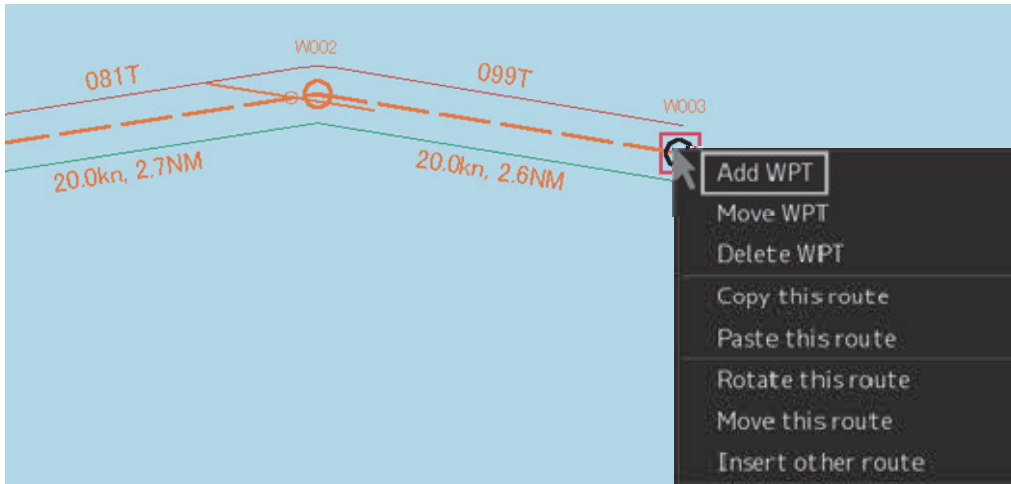

The cursor changes to the WPT addition mode.

- 3 Move the cursor on the position of the WPT to be added.**

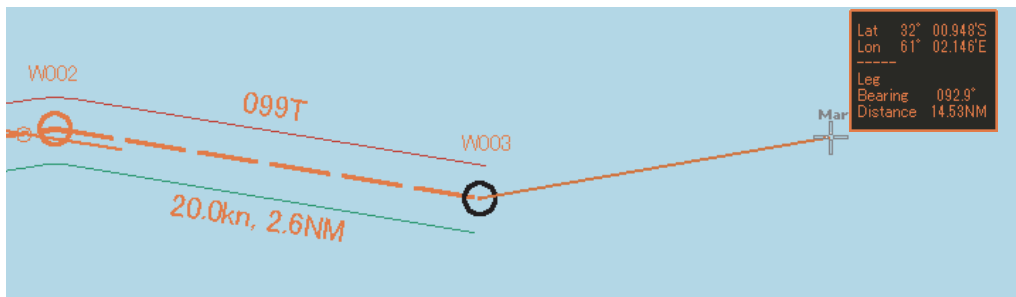

- 4 Click the mouse button.**

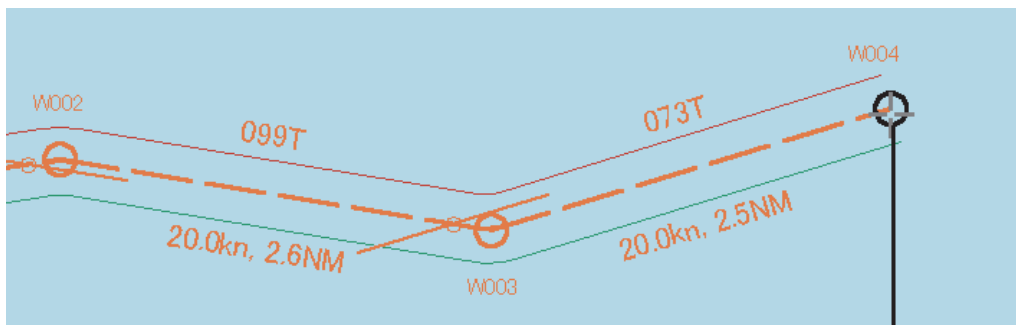

WPT that was added

WPT is added.

Note

In the case of ARCS, when WPT is specified at a position other than the active chart and another panel exists at the position, the panel display changes automatically.

Cancelling the operation

The addition operation can be cancelled by clicking the right button instead of clicking at Step 4.

9.7.3.5 Moving WPT on the context menu

- 1 Click the right button on the WPT to be moved.

The context menu is displayed.

- 2 Click the [Move WPT] on the context menu.

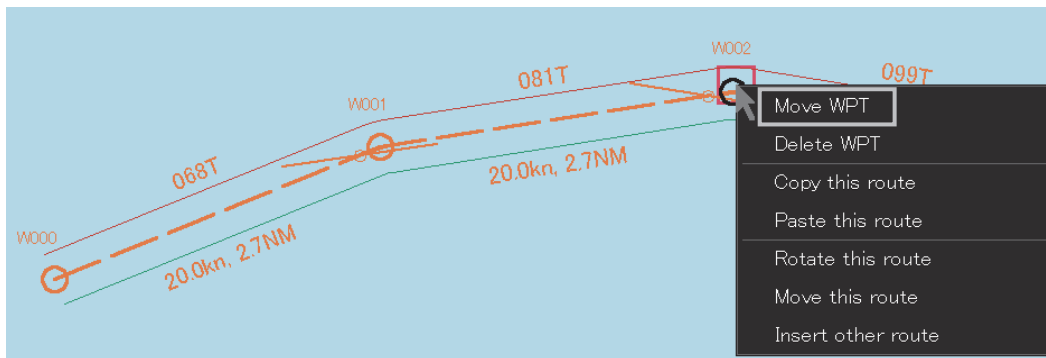

The cursor mode changes to the WPT move mode.

- 3 Move the cursor to the required position.

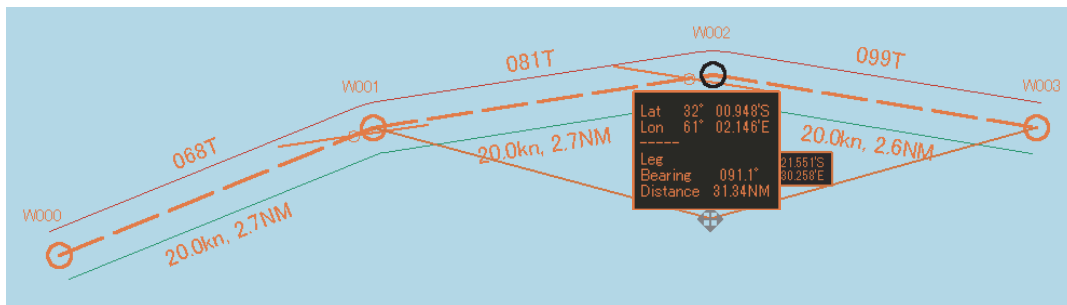

- 4 Click the mouse button.

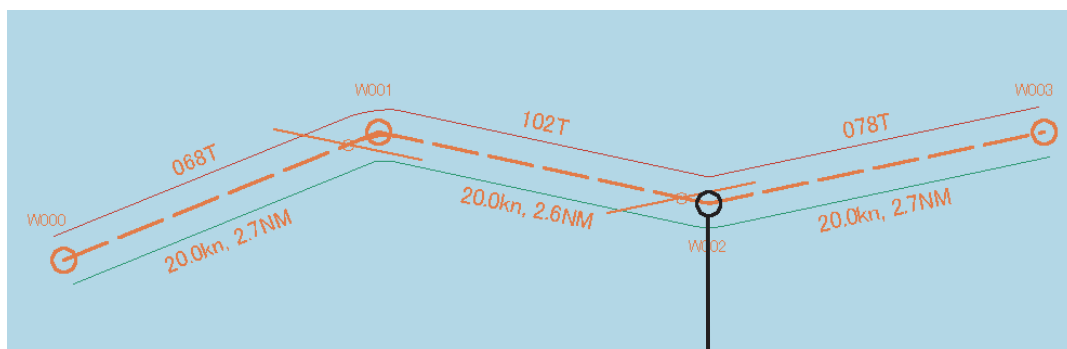

WPT that was moved.

Cancelling the operation

The addition operation can be cancelled by clicking the right button instead of clicking at Step 4.

9.7.3.6 Deleting WPT on the context menu

- 1 Click the right button on the WPT to be deleted.
The context menu is displayed.
- 2 Click [Delete WPT] on the context menu.

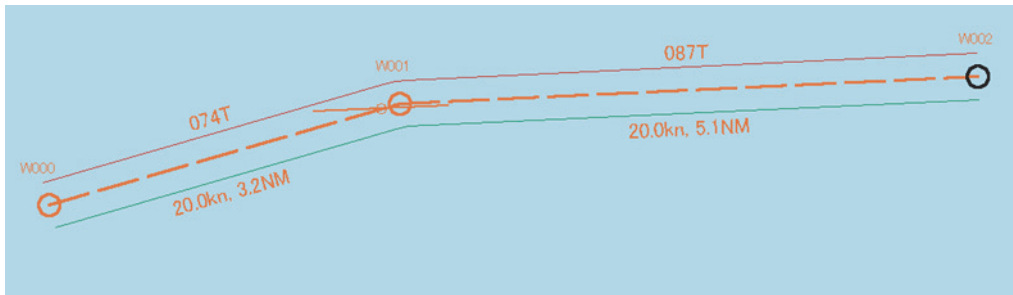
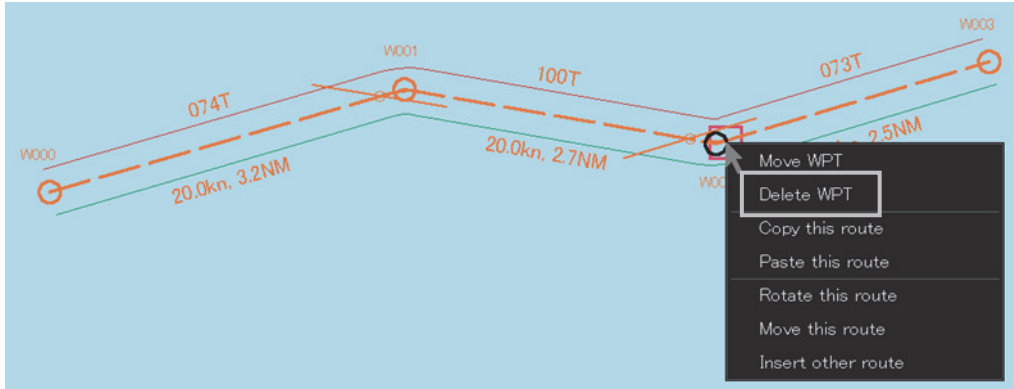

The WPT is deleted.

9.7.3.7 Copying and pasting a route on the context menu

A route can be copied and pasted on to another route file.

- 1 Click the right button on a WPT of the route to be copied.

The context menu is displayed.

- 2 Select [Copy this route] on the context menu.

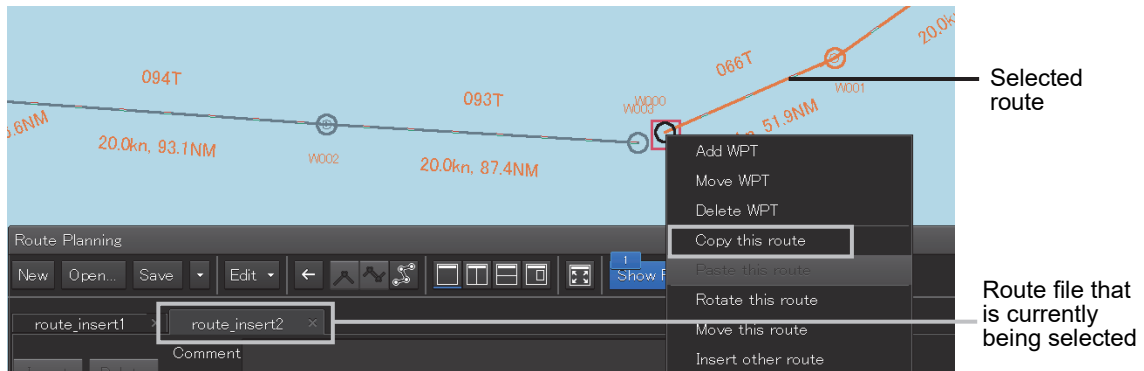

The route is copied.

- 3 Open the route file of the paste destination by switching the tab.

- 4 Select the route to be pasted and click the right button.

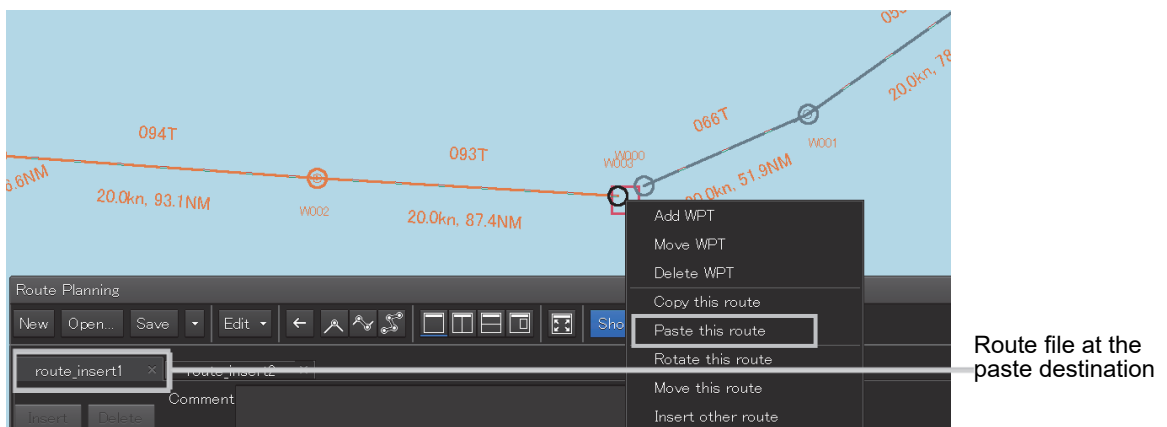

- 5 Click on [Paste this route] in the context menu.

The copied route is pasted to the selected route.

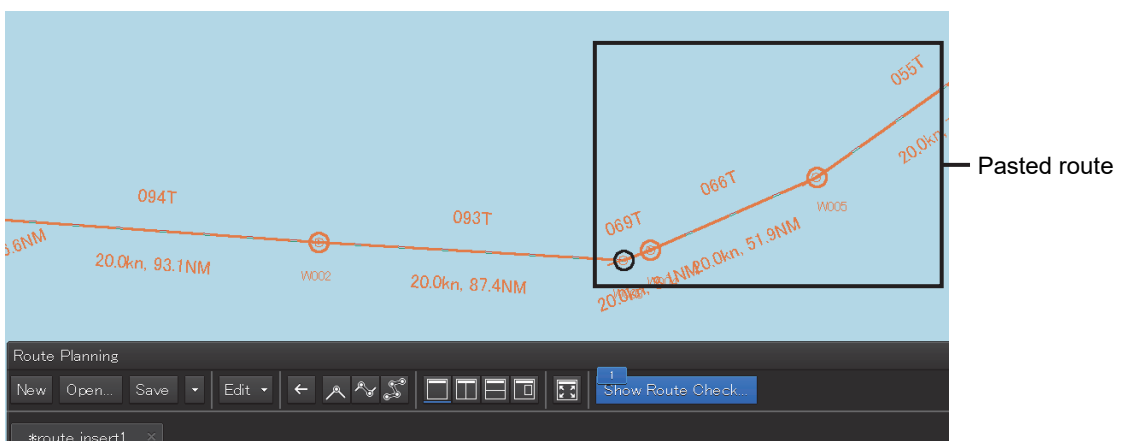

Note

At pasting, BWV, Distance, Total Distance, ROT, TWOL, and ETA are recalculated. When a Route planning error occurs as a result, an error message is displayed and insertion and pasting are not performed. For the error messages that are displayed, refer to "9.12 Error Messages that are Displayed when a Route is Created".

9.7.3.8 Rotating a route on the context menu

- 1 Click the right mouse button on the WPT No. that is used as the reference of rotation.
The context menu is displayed.
- 2 Click [Rotate this route] on the context menu.

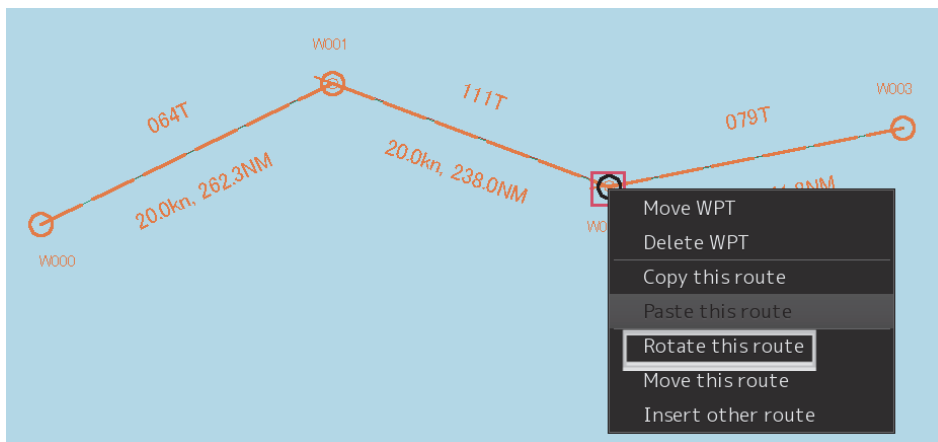

- 3 Rotate the route.

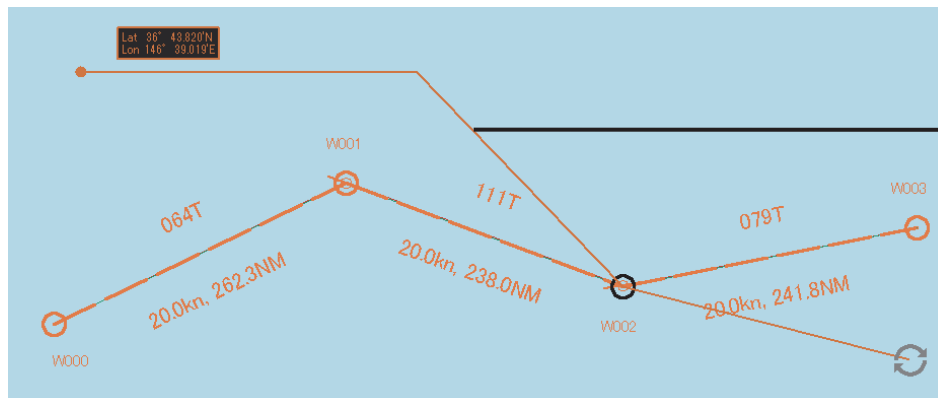

The route rotates based on the selected WPT

4 Click the mouse button.

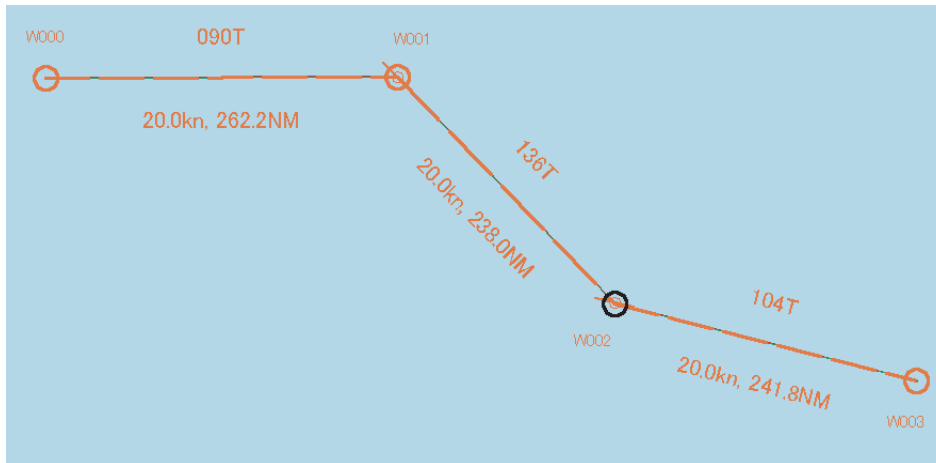

Cancelling the operation

The addition operation can be cancelled by clicking the right button instead of clicking at Step 4.

9.7.3.9 Moving a route on the context menu

- 1 Click the right mouse button on the WPT of any of the routes to be moved.
The context menu is displayed.
- 2 Click [Move this route] on the context menu.

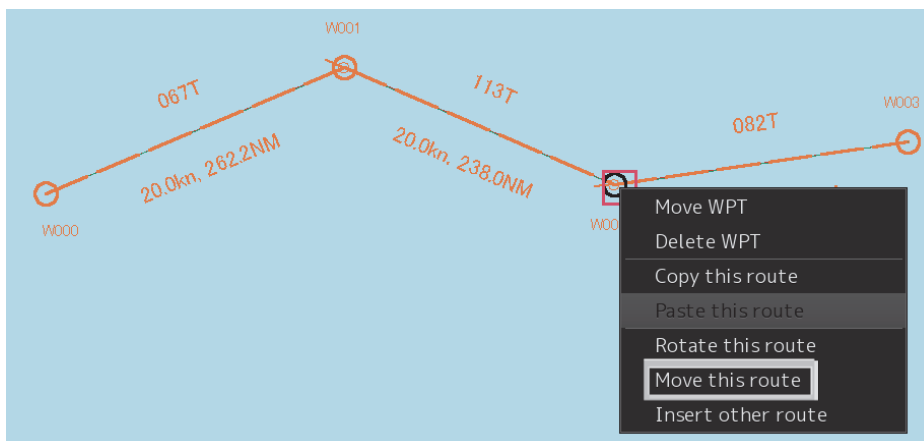

3 Move the route.

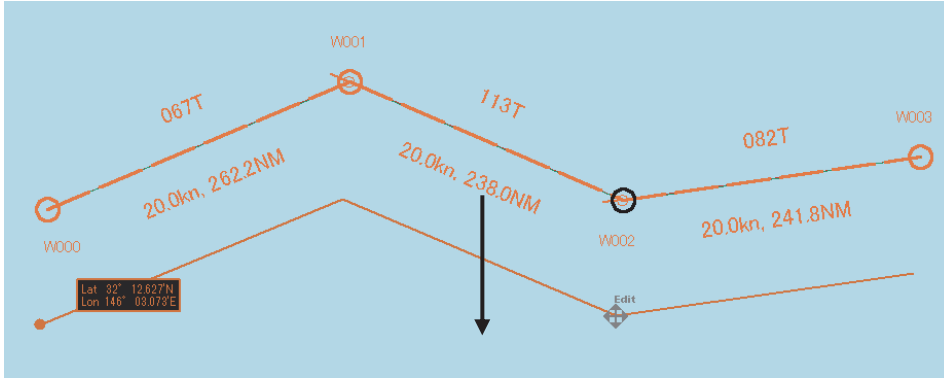

4 After positioning the route, click the mouse button.

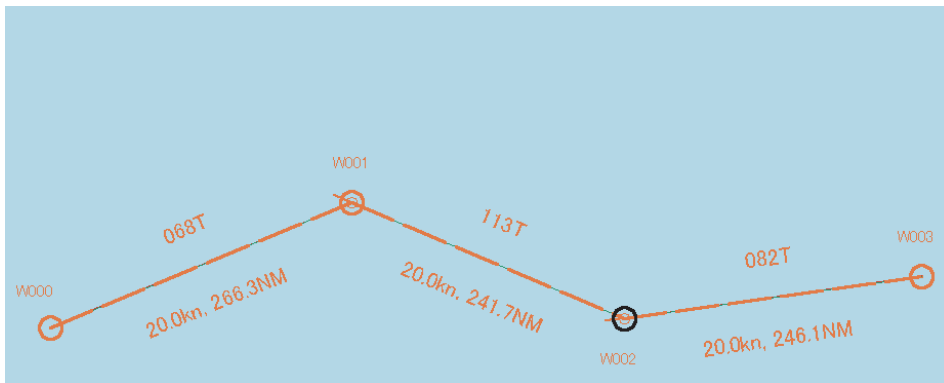

lab C Cancelling the operation

The addition operation can be cancelled by clicking the right button instead of clicking at Step 4.

9.7.3.10 Inserting other route on the context menu

Insert the route of another file into the last WPT of the route.

1 Click the right mouse button on WPT No.

The context menu is displayed.

2 Click on [Insert other route] in the context menu.

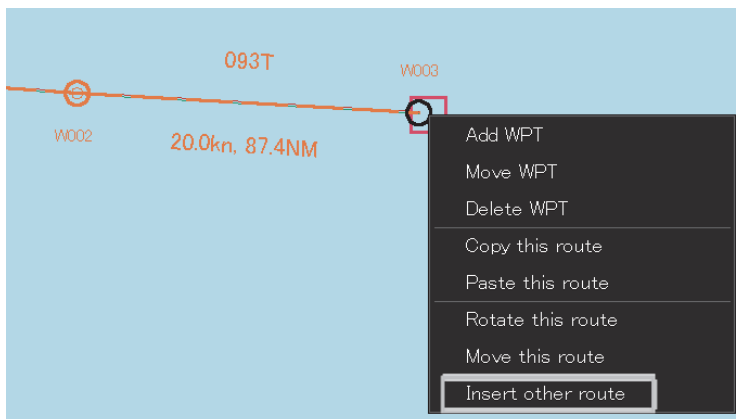

The [Insert other route] dialog is displayed.

- 3 Click on the route file to be inserted from the [Select Route] combo box.
- 4 Click on the [OK] button.

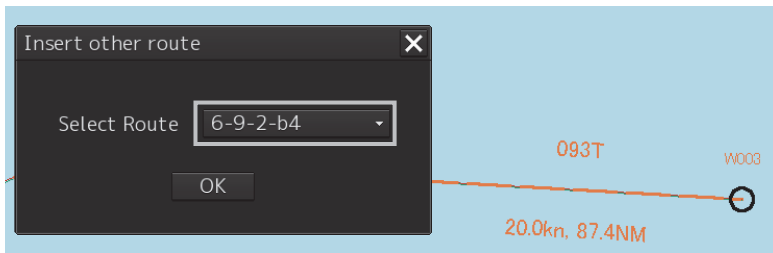

The route file is inserted.

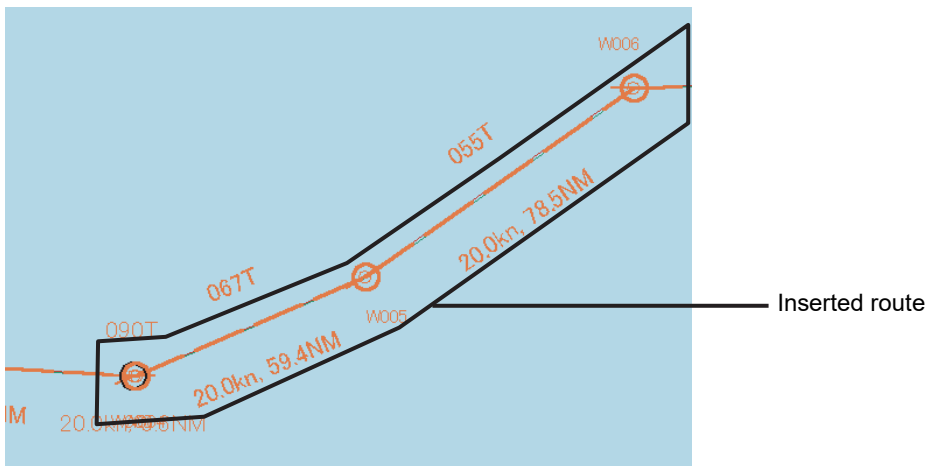

Note

When the range exceeded the insertion allowed range, an error message is displayed and the route will not be inserted.

9.7.3.11 Inserting WPT between WPTs on the context menu

- 1 Click the right mouse button on the leg between the WPTs within which WPT is to be inserted.
The context menu is displayed.
- 2 Click [Insert WPT] on the context menu.

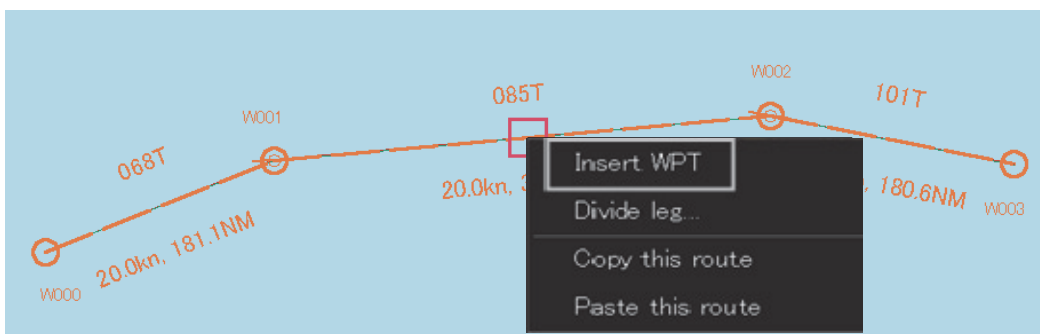

The cursor mode changes to the WPT insertion mode.

3 Move the cursor to the position in which WPT is to be inserted.

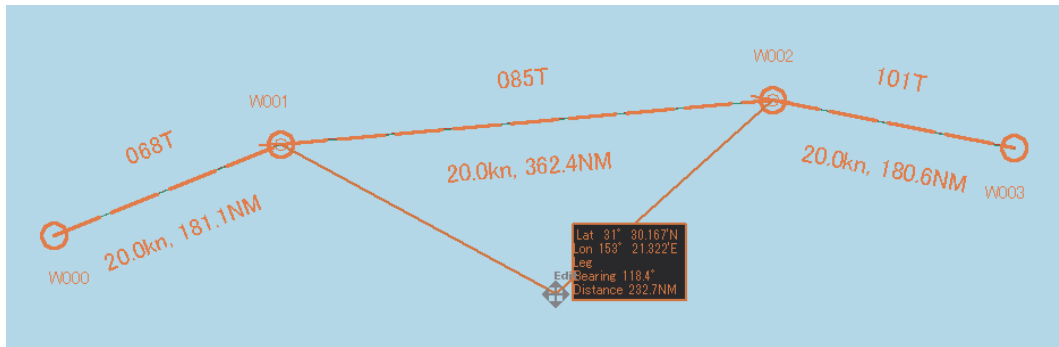

4 Click the mouse button.

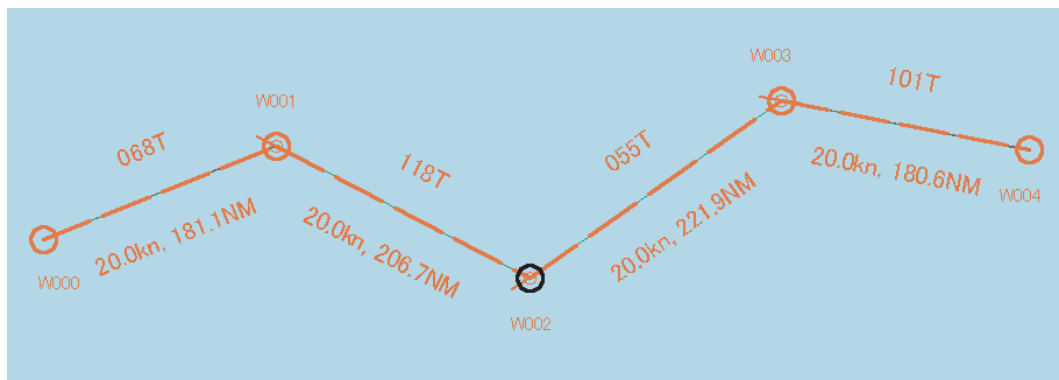

WPT is inserted.

Cancelling the operation

The insertion operation can be cancelled by clicking the right button instead of clicking at Step 4.

9.7.3.12 Dividing a leg on the context menu

- 1 Click the right mouse button on the leg of the route to be divided.

The context menu is displayed.

- 2 Click [Divide leg...] on the context menu.

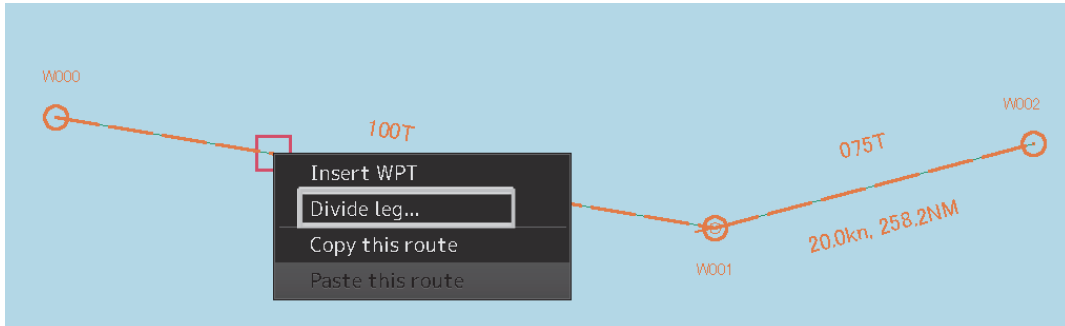

The [Divide Route] dialog box appears.

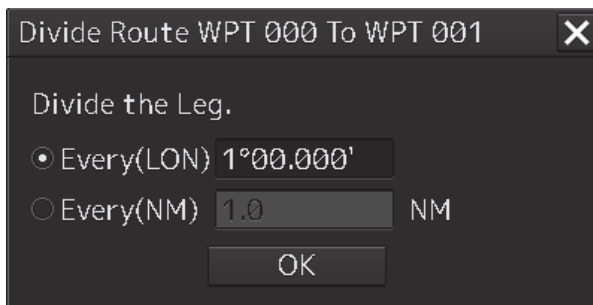

- 3 Input a division interval.

[Every(LON)] (longitude division)

- 1) Click on "Every(LON)".
- 2) Enter a longitude division interval.

[Every(NM)] (nautical mile division)

- 1) Click on "Every(NM)".
- 2) Enter a nautical mile division interval.

- 4 Click on the [OK] button.

The leg that was selected in Step 1 is divided in the unit specified in Step 3.

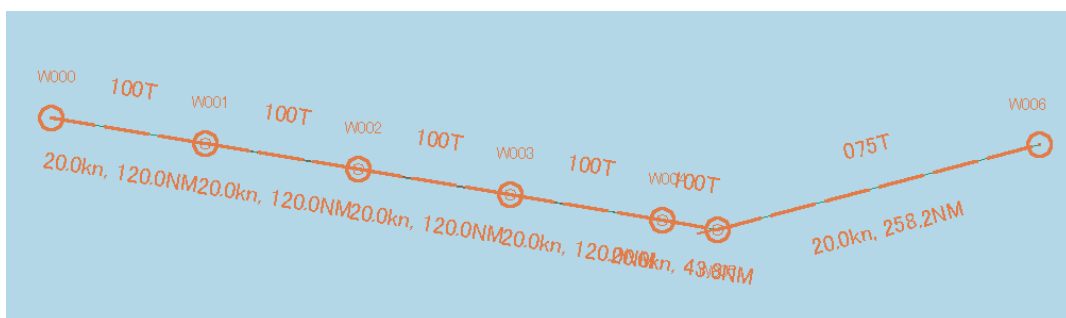

Note

When the total number of WPTs exceeds the maximum value of 511 as a result of leg division, leg division is executed within the range that does not exceed 511 in the entire course.

9.7.3.13 Changing XTD (cross track limit) on the context menu

- 1 Click the right mouse button on XTD.
The context menu is displayed.
- 2 Click [Change XTD] on the context menu.

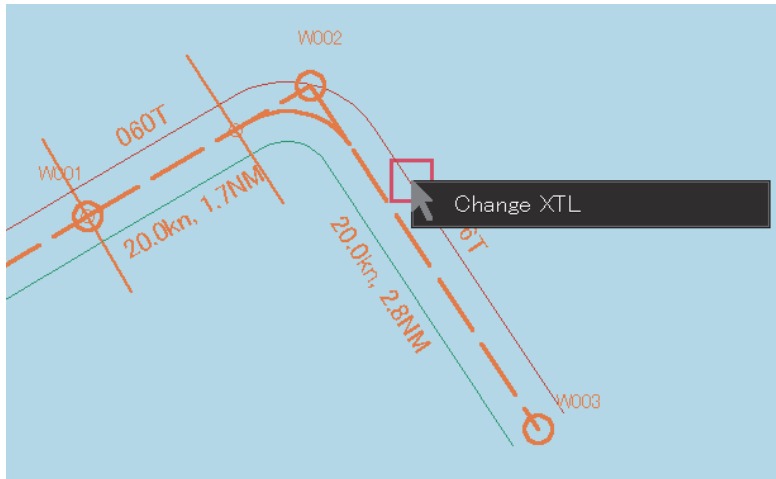

- 3 Change the width of XTD by moving the cursor.



4 Click the mouse button.

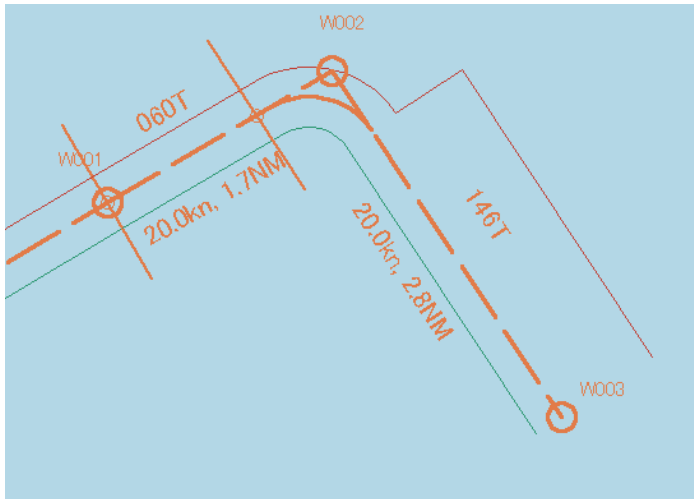

The XTL width is changed.

Cancelling the operation

The operation can be cancelled by clicking the right button instead of clicking at Step 4.

9.8 Creating an Alternate Route

An alternate route can be created during sailing by referencing the route that is displayed on the screen. The alternate route can be saved by overwriting during monitoring or by assigning a new name.

The following two charts indicate the original route and the changed alternate route. As shown below, an alternate route is created while the original route is displayed during creation of an alternate route.

In the example below, the following WPTs are changed.

- W001 Position (shift)
- W002 (Insertion. As a result, the following WPT number is incremented by 1.)
- W006 (One WPT is added to the last WPT.)

Memo

The original route is displayed in red to distinguish it from the alternate route.

Original route

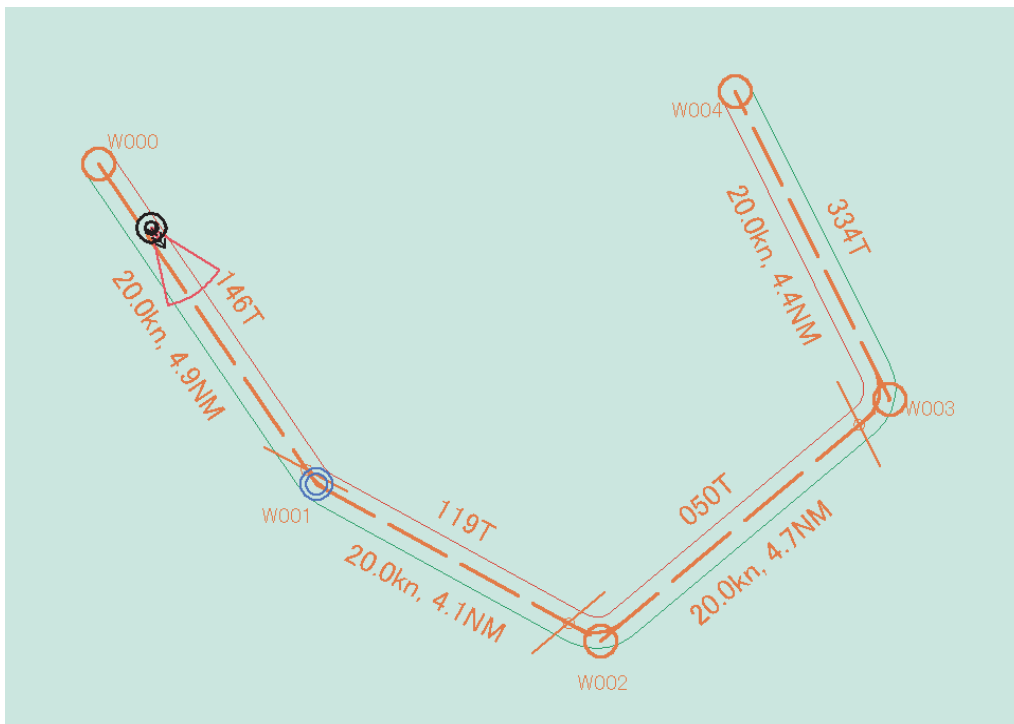

Original route and alternate route

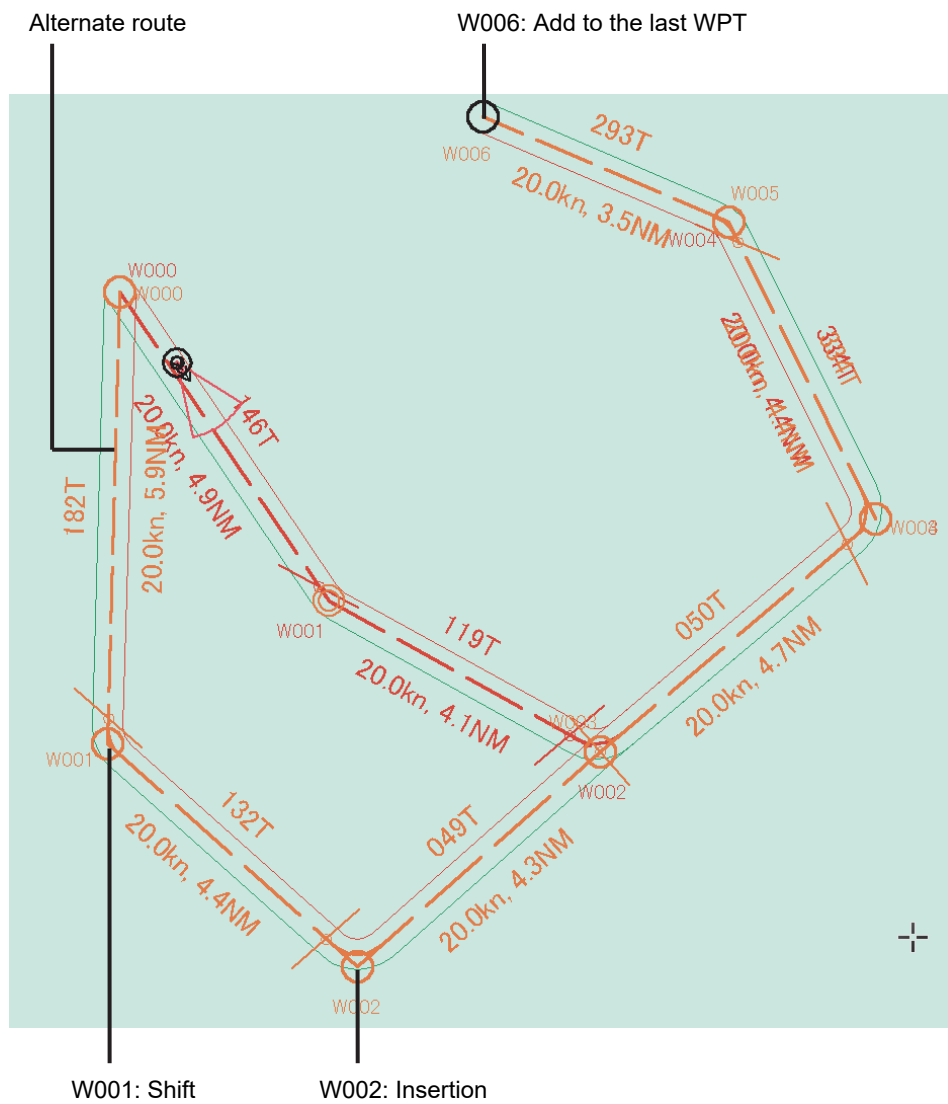

9.8.1 Creating an alternate route

- 1 Click the right mouse button on the WPT or leg of the route that is being monitored.
The context menu is displayed.
- 2 Click on [Monitoring WPT xxx] or [Monitoring LEG xxx] of the context menu.

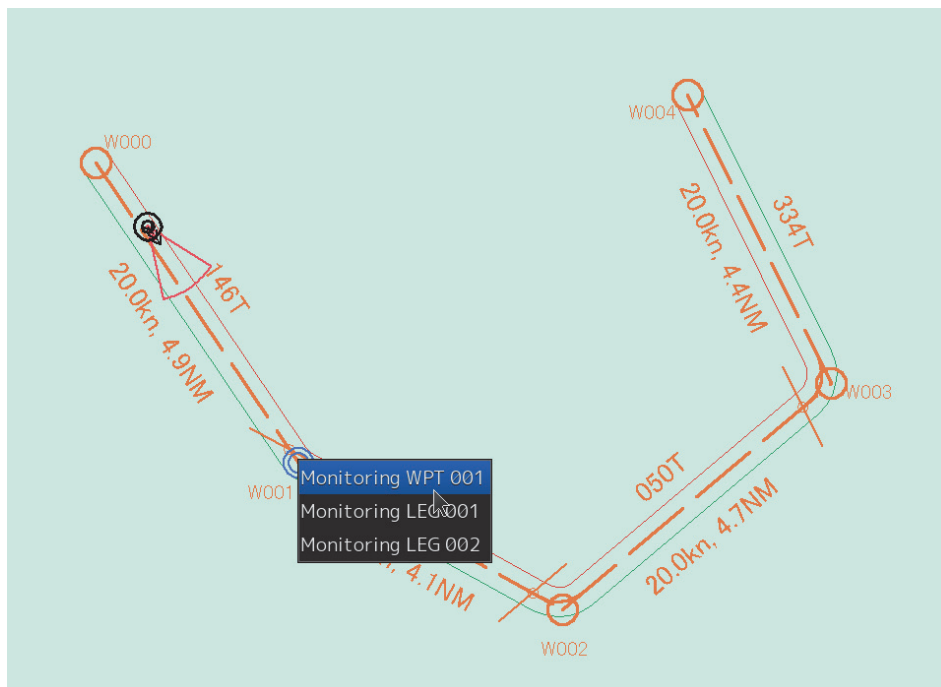

The context menu is displayed.

- 3 Click on [Edit this route] of the context menu.

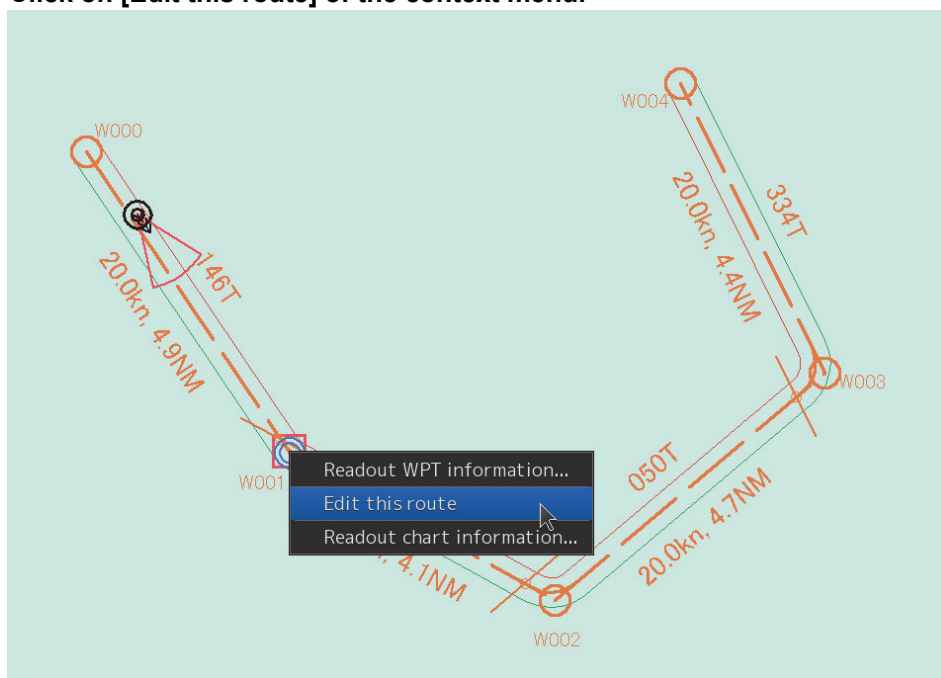

The [Route Planning] dialog is displayed.

- 4** For table editing, edit the route by using the same procedure as that from Step 3 of “9.6.4 Editing a route by table editing”.
- 5** For graphic editing, click the right mouse button on the WPT or leg of the route that is being monitored.
The context menu is displayed.
- 6** Click on [Planning WPT] or [Planning LEG] of the context menu.

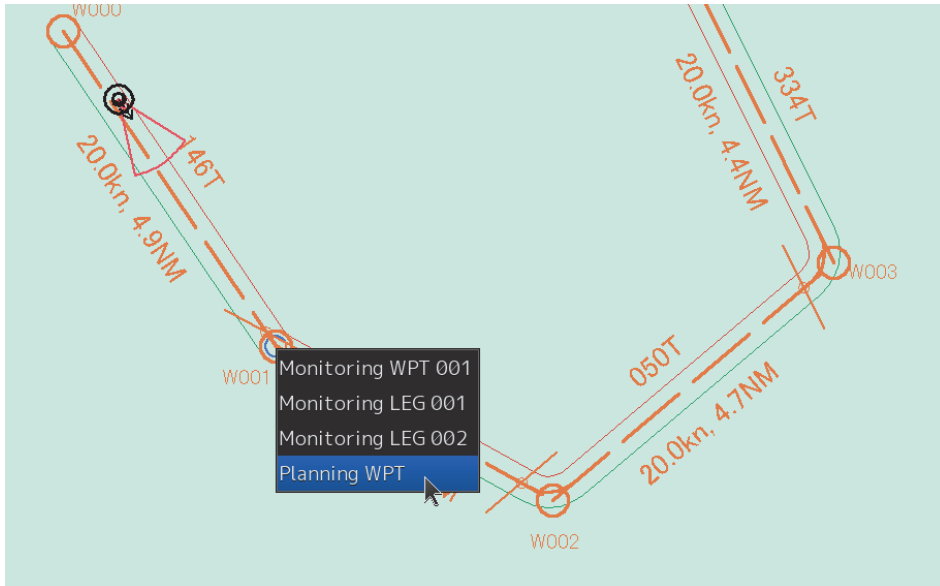

The context menu for editing WPT or leg is displayed.

- 7** Edit the route by using the same procedure as from Step 3 of “9.7.3 Editing a route by using graphic editing”.

9.8.2 Saving an alternate route

9.8.2.1 Overwriting without changing the file name

- 1** Click on the [Save] button.
A confirmation dialog is displayed.
- 2** Click on the [YES] button.

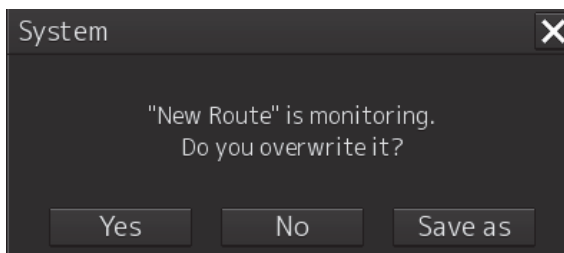

The alternate route is displayed and used instead of the original route.

Note

In this case, the route name that is currently monitored remains unchanged. The original route file no longer exists since it is overwritten.

9.8.2.2 Saving the file by naming

1 Click on the [Save as] button on the route plan menu of the route plan bar.

The [Save as Route File] dialog is displayed.

2 Enter a new file name and click on the [Save] button.

The alternate route is displayed and used instead of the original route.

Note

In this case, the route name that is being monitored is changed to the file name that was entered. The original route file remains.

9.9 Checking Route Data

Route data is constantly checked based on the safety standards and limits.

These items are checked on the [Check Route] dialog box.

The [Check Route] dialog box appears by clicking on the [Show Route Check] button on the Route Planning bar.



9.9.1 Checking a route based on the safety standards

The result of safety check is displayed on the [Safety check] tab.

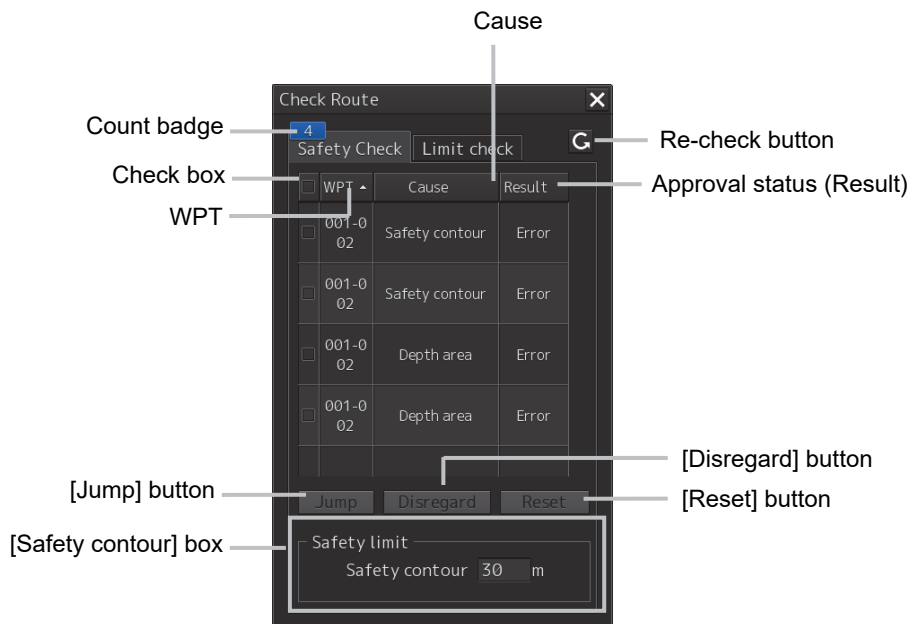

When safety errors are detected, the number of errors is displayed on the count badge. When the error count exceeds 999, "More" is displayed instead of the count.

The list of Cause and Result of the errors that were detected is displayed for each WPT prior to and following the error occurrence point. The following causes are displayed.

Cause
SpeConAre(Traffic separation zone)
SpeConAre(Traffic crossing)
SpeConAre(Traffic roundabout)
SpeConAre(Traffic precautionary)
SpeConAre(Two way traffic)
SpeConAre(Deeper water route)

Cause
SpeConAre(Recommended traffic lane)
SpeConAre(Inshore traffic zone)
SpeConAre(Fairway)
SpeConAre(Restricted area)
SpeConAre(Caution area)
SpeConAre(Offshore production area)
SpeConAre(Military practice area)
SpeConAre(Seaplane landing area)
SpeConAre(Submarine transit area)
SpeConAre(Canal)
SpeConAre(Fishing ground)
SpeConAre(Fishing prohibited)
SpeConAre(Pipeline area)
SpeConAre(Cable area)
SpeConAre(Anchorage area)
SpeConAre(Anchorage prohibited)
SpeConAre(Dumping ground)
SpeConAre(Cargo transshipment area)
SpeConAre(Incineration area)
SpeConAre(Specially protected area)
SpeConAre(Safety contour)
SpeConAre(Coast line)
SpeConAre(Obstruction)
SpeConAre(Under water rock)
SpeConAre(Wreck)
SpeConAre(Spoil ground)
SpeConAre(Sensitive sea area)
SpeConAre(Archipelagic sea lane)
SpeConAre(Marine farm/aquaculture)
AtoN
Vertical Clearance
Hazard
Caution Object
Warning object
Alarm Object
Sounding
PSSA (Particularly Sensitive Sea Area)
Areas to be avoided

memo

When the S63 chart and the C - MAP chart are used in combination with the safety check function, the S63 chart takes precedence.

Updating an error list

By clicking on the Re-check button, the latest error information is displayed by rechecking the information.

Sorting error display

By clicking on any of the items on the title line, error display can be sorted based on the item. A sort mark (▲ or ▼) is displayed on the title of the selected item.

Whenever an item is clicked on, the error display is sorted based on the ascending (▲) or the descending (▼) order.

Selecting an error to be processed

Select the check box of the error to be processed. To select all the errors, select the check box on the title line.

When the [Jump] button is clicked on, control jumps to the occurrence point of the error that was selected on the error list.

Ignoring an error

Click on the [Disregard] button. To restore the error that was once ignored, click on the [Reset] button.

Checking an error target on the list

When an error is detected, the WPT under which the error occurred is highlighted in red.

WPT No.	Name	Position		Leg		Sail	XTD		Arrival Radius	Turning Radius	Planned Speed	ROT	ETA [YYYY-MM-DD hh:mm]	Time Zone	TWOL [Days hh:mm]	T Dis
		LAT	LON	BWW	Distance		PORT	STBD								
0		32°50.110'S	60°59.942'E										2013-12-11 05:52	00:00		
1		32°26.329'S	60°58.790'E	345.5°	3.9NM	RL	0.20NM	0.20NM	0.50NM	0.50NM	15.0kn	28.6°/min	2013-12-11 06:07	00:00	00 Days 00:15	
2		32°27.492'S	61°06.411'E	150.2°	1.8NM	RL	0.20NM	0.20NM	0.50NM	0.50NM	20.0kn	38.2°/min	2013-12-11 06:15	00:00	00 Days 00:05	
3																

Checking an error target on the route

When an error is detected, the [Safety contour Alert] object in the Alert List is displayed in red and [Navigational Hazard Alert] and [Area Alert] are highlighted in yellow.

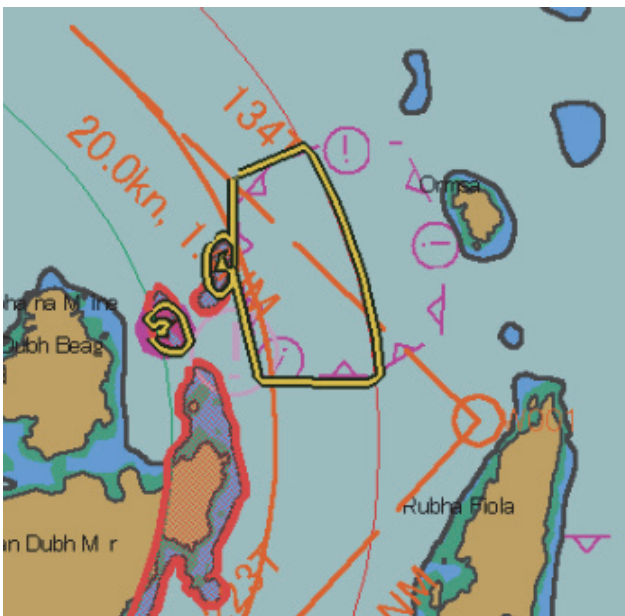
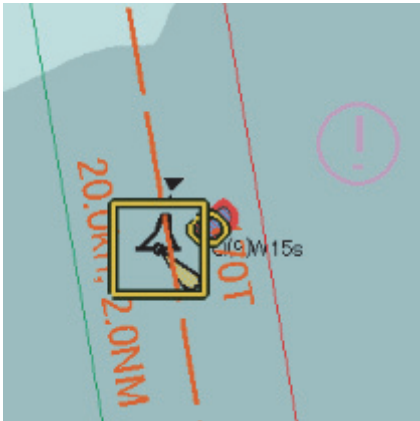

When error display is clicked on the error list, the error target are highlighted.

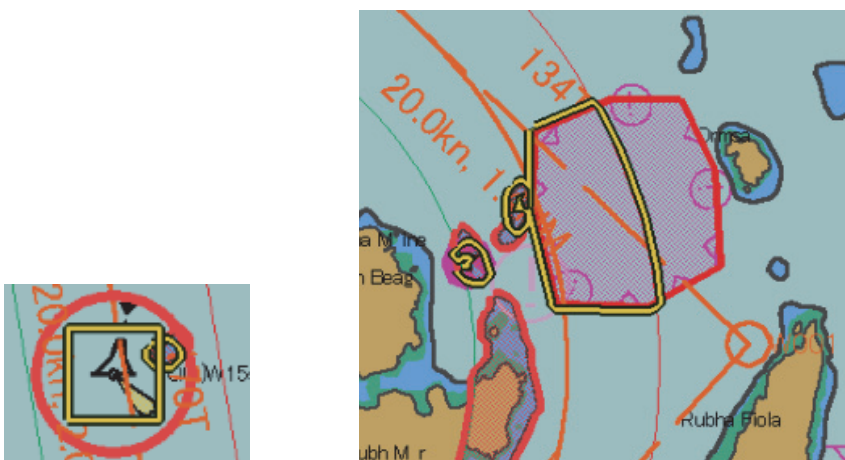

9.9.2 Checking a route based on the limits

The result of limit check is displayed on the [Limit Check] tab.

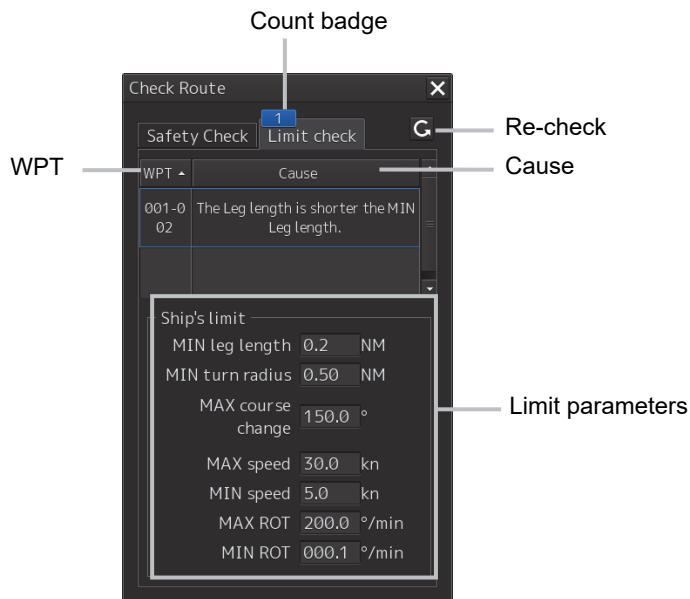

When limit errors are detected, the error count is displayed on the count badge. When the error count exceeds 999, "More" is displayed instead of the count.

The cause of the error that was detected is displayed for each of WPTs prior to and following the error occurrence point.

The following causes are displayed.

Cause
The planned radius is beyond the MAX turning radius.
The planned radius is under the MIN turning radius.
The course angle of leg is beyond the maximum.
The planned speed is beyond the MAX planned speed.
The planned speed is under the MIN planned speed.
The planned ROT is beyond the MAX ROT.
The planned ROT is under the MIN ROT.
The leg length is shorter the MIN Leg length.
The straight route cannot be created.

Updating error display

By clicking on the re-check button, the latest error information is displayed by rechecking the information.

Sorting error display

By clicking on any of the items on the title line, error display can be sorted based on the item. A sort mark (▲ or ▼) is displayed on the title of the selected item.

Whenever an item is clicked on, the error display is sorted based on the ascending (▲) or the descending (▼) order.

Verifying an error target on the list

When an error is detected, WPT of the error target is highlighted in yellow.

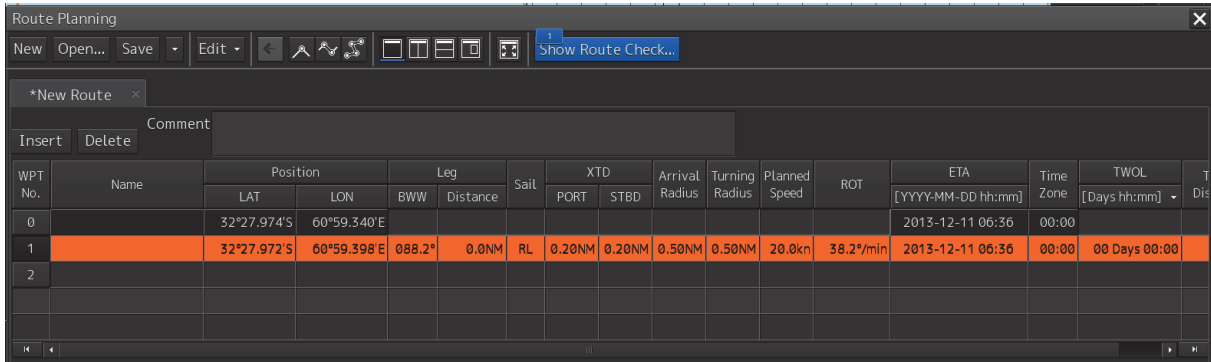

9.10 Navigation Calculation Function

This section describes the function that supports the distance and bearing calculation that are required for navigation.

Turning Radius	Planned Speed	ROT	ETA	Time Zone	TWOL	Total Distance
			[YYYY-MM-DD hh:mm]	Days hh:mm] ▾		
			2017-02-22 04:34	00:00		
0.50NM	20.0kn	38.2°/min	2017-02-22 10:25	00:00	00 Days 05:50	116.9NM
0.50NM	20.0kn	38.2°/min	2017-02-22 10:52	00:00	00 Days 00:26	125.9NM
0.50NM	20.0kn	38.2°/min	2017-02-22 16:11	00:00	00 Days 05:18	232.3NM
0.50NM	20.0kn	38.2°/min	2017-02-22 16:15	00:00	00 Days 00:04	233.7NM

9.10.1 ROT (Rate of Turn)

ROT is automatically calculated from the planned ship's speed and the turn radius and displayed on [ROT].

9.10.2 ETA (Estimated Time of Arrival)

ETA is automatically calculated from the WPT position, planned ship's speed, and time zone and is displayed on [ETA].

When ETA includes a date other than the current date, Viewing Does Not Include Current Date is displayed in Permanent Information because displaying of a date-dependent object is executed.

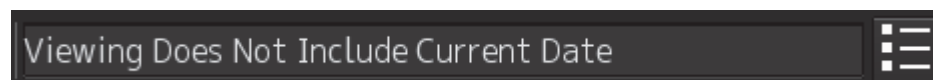

Detailed wording which each ETA's range is displayed within one day, each one or more is different.

When the ETA range is one day or less

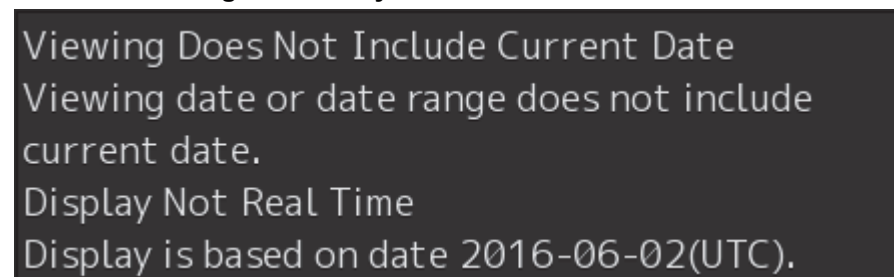

When the ETA range is greater than one day

Viewing Does Not Include Current Date
Viewing date or date range does not include current date.
Display Not Real Time
Display is based on viewing date range from 2016-06-01(UTC) to 2016-06-02(UTC).

* For the date-dependent objects, refer to the following.

Section 13 – 13.5 Displaying a Date-dependent Object – Displaying an indication in duration specification.

9.10.3 TWOL (Time to Go)

TTG is automatically calculated from the WPT position and planned ship's speed and displayed on [TWOL].

A display format can be selected from the list that is displayed by clicking on the TWOL title.

[Days hh:mm]

01Days 23:59

[hhhh:mm]

9999:59

Memo

In the navigation calculation function, each value is calculated using CCRP as a reference point.

9.11 Importing/Exporting a Route File

By using the [Import] or [Export] dialog box, the route file that was created can be imported/exported. The dialog box can be displayed as follows.

- 1 Click on the **Route Planning** menu button.
- 2 Select **[Import]** or **[Export]** from the list that is displayed.
The "Import" or [Export] dialog box appears.

9.11.1 Importing a route file

- 1 Specify the "Drive", the "Folder", the "File name", and the "File Type" that stores the file to be imported.
- 2 Click on the **[OK]** button.

The route file that is selected can be imported.

Press the [X] button to cancel the importing of a file.

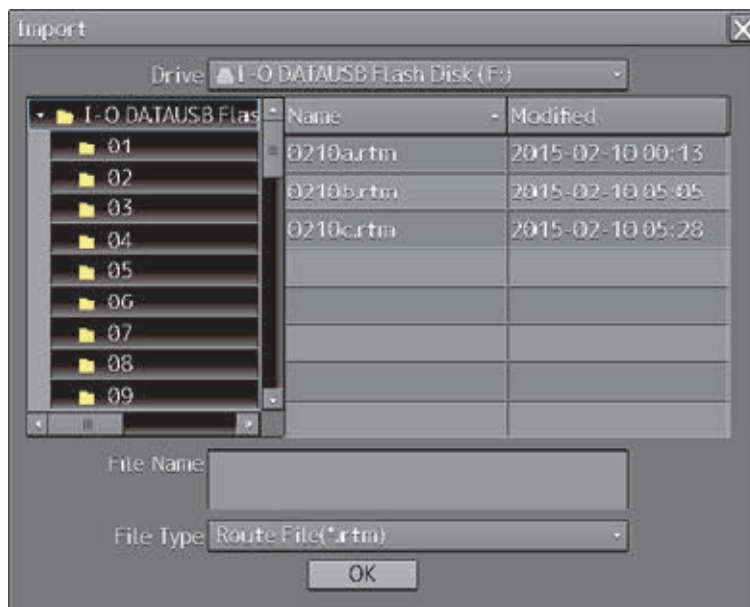

Note

The file type of the file to be imported can be selected in the [File Type] combo box. The file types that can be imported are as follows.

.rtn: Displays a route file (normal).

This file is used for ECDIS (JAN-701B/901B) and Chart Radar (JMA-900B)

.rta: Displays a route file (TCS route).

This file is used for ECDIS (JAN-701B/901B) and Chart Radar (JMA-900B)

.rtm: Displays a route file used in this equipment.

.rtz: Displays a route file (the route plan exchange format specified in IEC61174). RTZ version 1.0 and RTZ version 1.1 are supported.

.csv: Displays a route file in CSV format.

*(Wildcard): Displays all the files that can be imported.

When importing a route file created by another company's device, be sure to check the route file with the route planning function before using it. If the XTL, Arrival Radius, PlanSpeed, Sail, Turn Radius, and Time Zone of the route file to be imported contain values outside the set range, the default values will be replaced and imported. (If a csv format route file containing values outside the set range is imported, an import error will occur. The value does not replace the default value)

9.11.2 Exporting a route file

1 Specify the "Drive", the "Folder", the "File name", and the "File Type" that stores the file to be exported.

2 Click on the [OK] button.

The route file that is currently opened is exported.

Press the [X] button to cancel the exporting of a file.

**Note**

When .rtz is selected, the route file will be exported in RTZ version 1.0 format.

9.12 Error Messages that are Displayed when a Route is Created

When a route is created, the following error messages may be displayed, disabling execution of the specified operation.

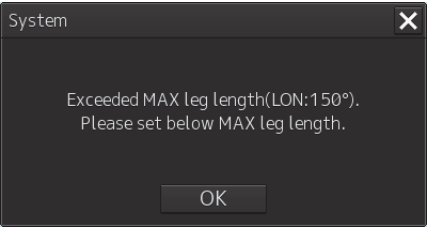
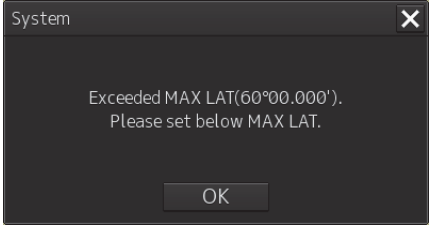
Error message	Status
	<p>The total number of WPTs exceeded the upper limit (511).</p>
	<p>The leg length exceeded the maximum value (longitude 150°).</p>
	<p>The latitude exceeded the latitude upper limit.</p>

Section 10 Route Monitoring

10.1 Route Monitoring

The route monitoring function enables monitoring of the position of own ship, heading, and ship speed, and calculation of an expected time of arrival using the route created in route planning.

Memo

For monitoring a route, it is necessary to create a route file or copy a route file in route planning in advance.

For the details of route planning, refer to "Section 9 Route Planning".

10

10.1.1 Starting route monitoring

- 1 Click on the [Menu] button on the left toolbar.

The menu is displayed.

- 2 Click on the [Route Monitoring] button on the menu.

The [Route Monitoring] dialog box appears.

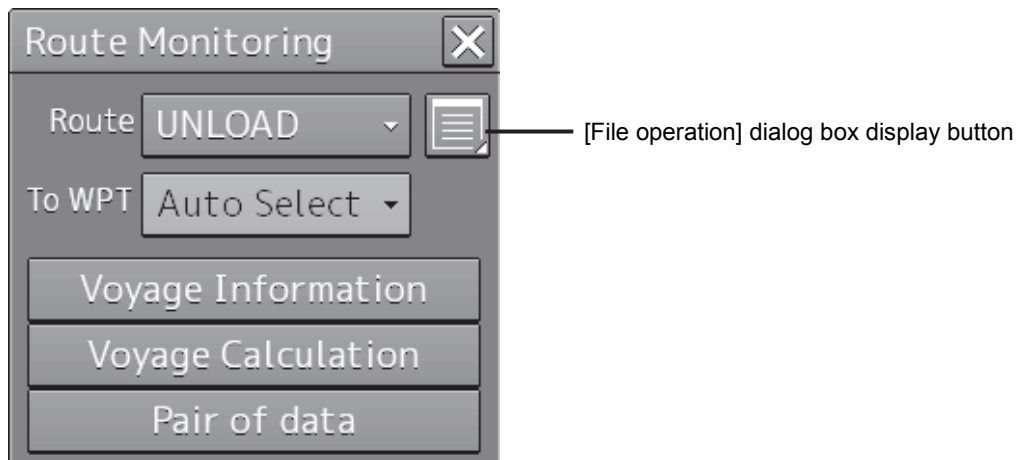

- 3 Select a required route file.

[Selecting from the [Route] combo box]

- 1) Click on the [Route] combo box.
- 2) Select a required route.

[Selecting from a route file list]

- 1) Click on the [File operation] dialog box display button.
- 2) Select a required file from the list of the [File operation] dialog box.

About the [File operation] dialog box, refer to "10.2 Selecting and Deleting Route Files"

- 3) Click on the [Open] button.

Limit check at the start of route monitoring

The limit check is automatically executed at the start of route monitoring.

At this time, if a turning radius error ("The straight route cannot be created.") is detected, return the route to unload and the following popup will be displayed.



Automatic safety checking after loading a route

When a route file is loaded, safety checking is executed automatically.

When an error is detected, the [Safety Contour Alert] object is displayed in red and [Navigational Hazard Alert] and [Area Alert] are highlighted in yellow.

4 Select a WPT to which the ship is to travel. A WPT can be selected automatically or manually.

[Automatic selection]

The nearest WPT from the own ship's position is selected automatically.

- 1) Open the next WPT list by clicking on the [To WPT] combo box.
- 2) Select [AUTO Select].

[Manual selection]

Select a WPT manually.

- 1) Open the next WPT list by clicking on the [To WPT] combo box.
- 2) Click on a required WPT.

10.1.2 Ending route monitoring

1 Click on the [Menu] button on the left toolbar.

The menu is displayed.

2 Click on the [Route Monitoring] button on the menu.

The [Route Monitoring] dialog box appears.

3 Click on the [Route] combo box.

4 Click on [UNLOAD].

10.2 Selecting and Deleting Route Files

Selection of the route to be displayed and deletion of obsolete route files are enabled on the [File operation] dialog box.

Use the following procedure to open the [File operation] dialog box.

- 1 Click on the [Menu] button on the left toolbar.**
The menu is displayed.
- 2 Click on the [Route Monitoring] button on the menu.**
The [Route Monitoring] dialog box appears.
- 3 Click on the [File operation] dialog box display button.**
The [File operation] dialog box appears.

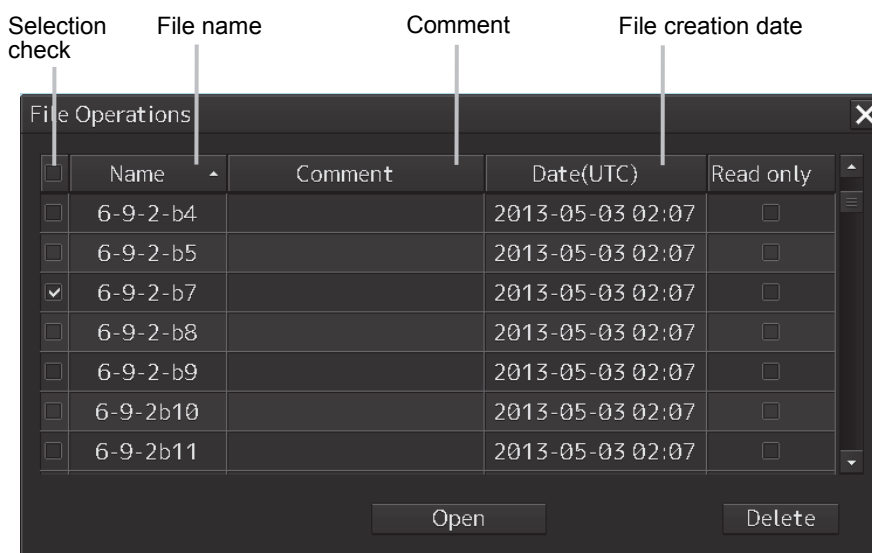

10.2.1 Selecting a route to be displayed

- 1 Select the selection check box of the route file to be displayed.**
When [Name] is clicked on, ▾ is displayed. Whenever ▾ is clicked on, the file display sequence changes to the ascending/descending sequence based on the names.
Likewise, when you click on [Comment] and [Data (UTC)], it switches in ascending / descending sequence.
- 2 Click on the [Open] button.**

10.2.2 Deleting a route file

- 1** Click the selection check of the route file to be deleted.
- 2** Click on the [Delete] button.
A message dialog box is displayed as to whether the deletion is to be executed.
- 3** When executing deletion, click on the [Yes] button. To cancel deletion, click on the [No] button.

Note

The file of the route that is currently monitored or the route that is used for automatic sailing cannot be deleted.

The following message dialog box appears.

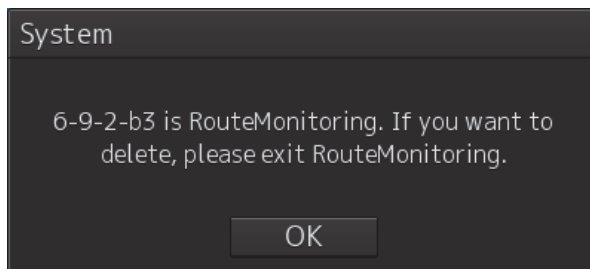

Close the dialog box by clicking on the [OK] button.

10.3 [Voyage Information] (Voyage Monitoring Information) Dialog Box

The [Voyage Information] (voyage monitoring information) dialog box is used to monitor voyage statuses.

In addition to voyage monitoring, execution of course change and termination of automatic navigation can also be performed.

Use the following procedure to open the [Voyage Information] dialog box.

- 1 Click on the [Menu] button on the left toolbar.**

The menu is displayed.

- 2 Click on the [Route Monitoring] button on the menu.**

The [Route Monitoring] dialog box appears.

- 3 Click on the [Voyage Information] button.**

The [Voyage Information] dialog box appears.

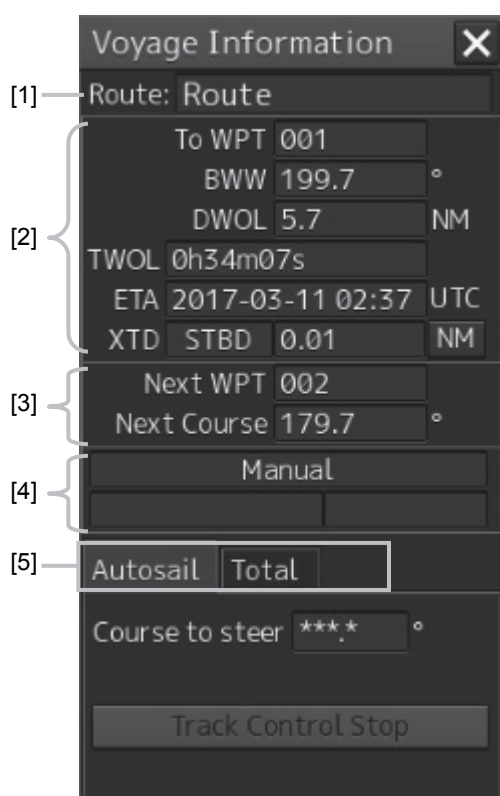

[1] Route name display

A file name of the route that is being monitored is displayed.

[2] To WPT information

The To WPT information that was selected in the [Route Monitoring] dialog box is displayed.

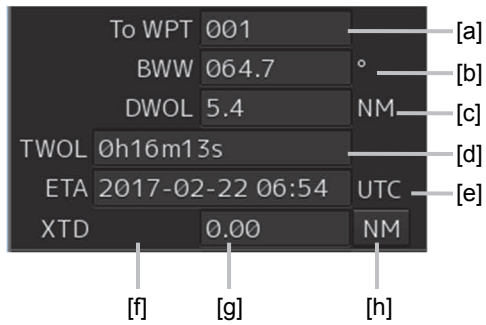

[a] [To WPT] (To WPT number)

Displays a To WPT number.

[b] [BWW] (Angle of own ship - To WPT)

Displays a bearing between the WPTs (To WPT bearing from the previous To WPT).

[c] [DWOL] (Distance of own ship - To WPT)

Displays the distance between own ship and To WPT.

[d] [TWOL] (Expected traveling time)

Displays an expected traveling time to reach the position indicated by To WPT.

[e] [ETA] (Expected time of arrival)

Displays the expected time of arrival at the position indicated by To WPT.

[f] Cross track direction

Displays a cross track direction of the own ship.

When the own ship is cross-tracked on the right side, [STBD] is displayed and when the own ship is cross-tracked on the left side, [PORT] is displayed.

[g] Cross track distance

Displays a cross track distance of the own ship.

[h] Cross track distance unit switching button

Switches the display unit of a cross track distance. Whenever the button is clicked on, the unit is switched to "m" or "NM".

[3] Next WPT information

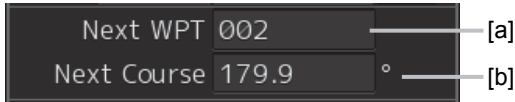

[a] [Next WPT] (Next WPT number)

Displays a Next WPT number.

[b] [Next Course] (Leg bearing of Next WPT)

Displays a leg bearing of the Next WPT.

[4] Automatic sailing information

This section displays the status of Auto Pilot that is installed.

Note

If the Auto Pilot device is not installed, information is not displayed.

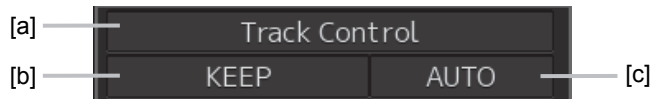

[a] Automatic sailing status

Displays an automatic sailing status.

Display	Status
No display	A/P (Auto Pilot) non-connection setting or automatic sailing alert is occurring
Track Control	The A/P steering mode is set to Track Control.
Heading Control	The A/P steering mode is set to Heading Control.
Manual	The A/P steering mode is set to Manual.
Override	Ship avoiding operation in progress

Memo

The display contents vary depending on the auto pilot that is installed. For the details, refer to the Auto Pilot Instruction Manual.

[b] Control mode

Displays a control mode of automatic sailing.

Display	Status
No display	Automatic sailing inactive
KEEP	Automatic sailing/maintaining the course
TURN	Automatic sailing/turning (TCS category C)

[c] Turning mode

Displays a turning mode of automatic sailing.

Display	Status
No display	Automatic sailing inactive
MAN	Manual course change mode
AUTO	Automatic turning mode

(5) Switching tab

When this tab is clicked on, the contents of the following dialog are switched.

[Clicking on the [Autosail] tab]

The dialog is switched to [Autosail] (automatic ailing) dialog.

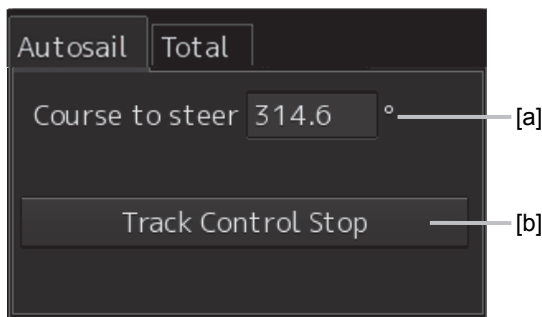

(a) Course to steer

Displays the course to steer to be transmitted to auto pilot.

(b) [Track Control Stop] (stop automatic sailing) button

To stop automatic sailing, click on this button.

The following message dialog is displayed.

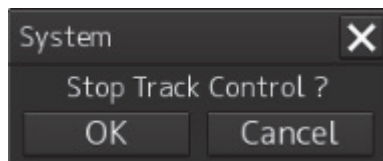

When the [OK] button is clicked on, automatic sailing terminates.

Memo

When a message dialog box indicating the switching of the Auto Pilot mode to the Manual mode is displayed, switch the Auto Pilot steering mode to the Manual.

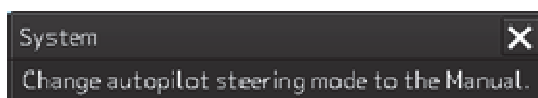

[Clicking on the [S-JOY] tab or [Joystick]tab]

The dialog is switched and information on Joystick is displayed.

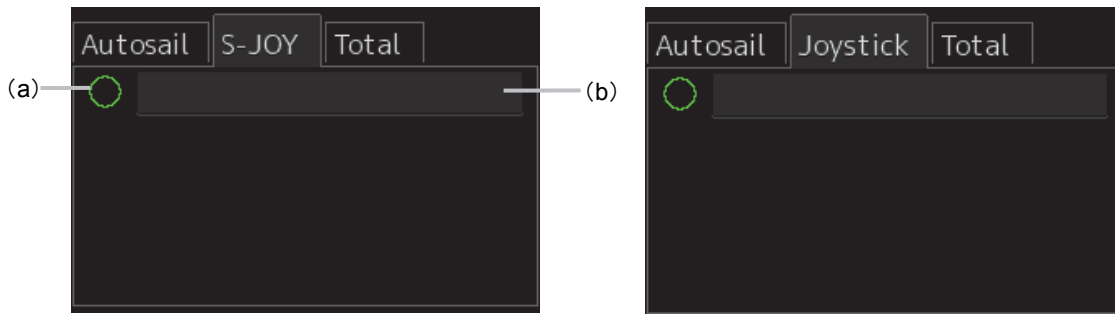

When using “S-Joy”

When using “MJS-9000”

Memo

- When Joystick is installed,[S-Joy]tab or [Joystick]tab is displayed.
- Depending on the status of Joystick that is installed,the display name of the tab is different.
 [S-Joy]tab:When “YOKOGAWA Joystick(S-Joy)” is installed.
 [Joystick]tab:When “TOKYO KEIKI Joystick(MJS-9000)” is installed.

(a) Steering right

Displays the steering right of Joystick.

When the steering right is available, the circle is filled.

(b) Mode

Displays the Joystick mode.

The contents that are displayed in the dialog vary as follows.

[When using “S-joy”]

mode	Contents that are displayed in the dialog
Track	ACT Rudder
Heading	Set HDG、Rudder Limit、ACT Rudder
Radius	Set HDG、Set Radius、ACT Radius、ACT Rudder
Planned Turn	Set HDG、Set Radius、ACT Radius、ACT Rudder
Rudder	Set Rudder、ACT Rudder、ROT

[When using “MJS-9000”]

mode	Contents that are displayed in the dialog
Track	ACT Rudder
Heading Control	Set HDG、Rudder Limit、ACT Rudder
Radius	Set HDG、Set Radius、ACT Radius、ACT Rudder
P-Turn	Set HDG、Set Radius、ACT Radius、ACT Rudder
Rudder Control	Set Rudder、ACT Rudder、ROT

[Clicking on the [Total] tab]

The dialog is switched to the [Total] dialog.

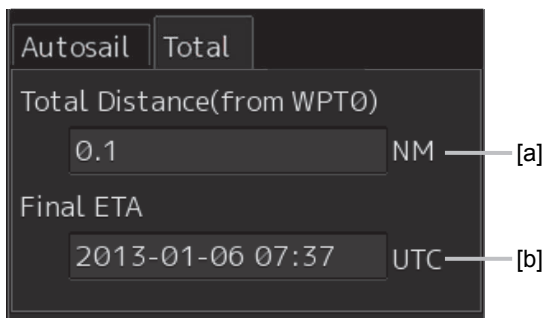

(a) [Total Distance (from WPT0)]

Displays the total distance from WPT0 to own ship.

(b) [Final ETA]

Displays the expected time of arrival to the final WPT that is calculated based on the current ship's speed.

10.4 [Voyage Calculation] Dialog Box

The [Voyage calculation] dialog box is used to calculate the expected WPT arrival time, the time required, and required ship speed

It is also possible to calculate a distance between two points such as between WPTs, from the own ship's position to WPT, or any position on the route to WPT.

Use the following procedure to open the [Voyage calculation] dialog box.

- 1 Click on the [Menu] button on the left toolbar.**
The menu is displayed.
- 2 Click on the [Route Monitoring] button on the menu.**
The [Route Monitoring] dialog box appears.
- 3 Click on the [Voyage calculation] button.**
The [Voyage calculation] dialog box appears.

When the [Schedule] (schedule calculation) button is clicked on, a schedule calculation dialog is displayed.

When the [Distance] (distance calculation) button is clicked on, a distance calculation dialog is displayed.

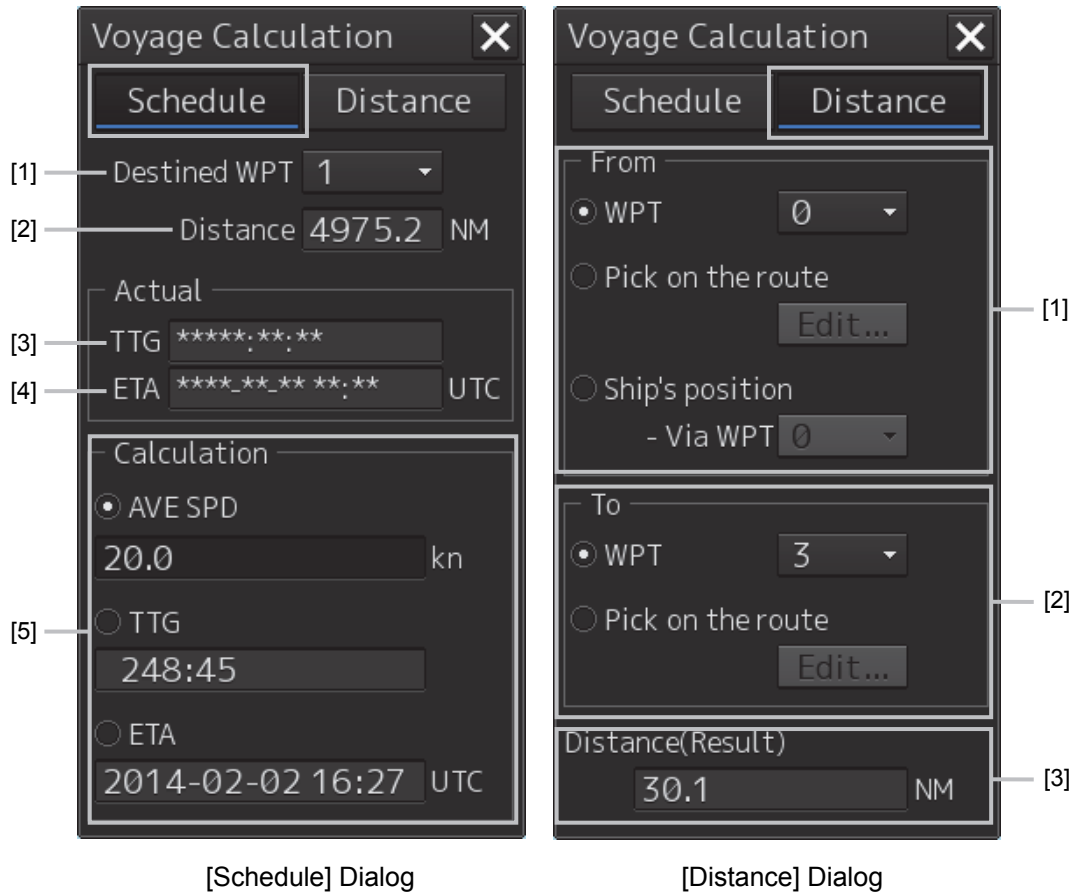

[Schedule] Dialog

[1] [Destined WPT] combo box

Select a destined WPT.

[2] [Distance] (Distance up to the destined WPT)

Displays a distance from the own ship's position to the selected WPT.

※[Setting]-[Route]-[Monitoring]-[Arrival circle] selected:[Distance]

[3] [TWOL] (Expected traveling time)

Displays a traveling time required based on the position from the current SOG value to the destined WPT.

※[Setting]-[Route]-[Monitoring]-[Arrivalcircle] selected:[TTG]

[4] [ETA] (Expeded time of arrival)

Displays a time at arrival of the destined WPT from the current SOG value.

[5] [Calculation] (Calculation)

Selects a calculation method and enters the values.

[Distance] Dialog

[1] [From]

Selects a starting point calculation method and enters the values.

[2] [To]

Selects an ending point calculation method and enters the values.

[3] [Distance (Result)] (Distance calculation result)

Displays distance from the starting point and ending point that were obtained from the setting.

10.4.1 Calculating a schedule

Voyage Calculation

Schedule Distance

Destined WPT 1

Distance 4239.6 NM

Actual

TTG 2119:47:37

ETA 2014-05-02 20:51 UTC

Calculation

Average Speed

20.0 kn

TTG

211:58

ETA

2014-02-12 09:02 UTC

- 1 Click on the [Schedule] button.
- 2 Click on the [Destined WPT] combo box.
- 3 Click on the WPT number whose schedule is to be calculated.

The measured distance from the own ship to the selected WPT, the estimated required time calculated based on the SOG (Speed Over the Ground), and the estimated time of arrival are displayed.

4 Select a calculation method and enter a value.

When [Average Speed] (calculated ship's speed), [TTG] (calculated traveling time), or [ETA] (calculated time of arrival) is selected and a value is entered, the calculation result of the ship's speed, expected traveling time, and expected time of arrival are displayed. These three items are displayed by linking.

[Average Speed]: Enter a ship's speed.

[TWOL]: Enter a calculated traveling time.

※[Setting]-[Route]-[Monitoring]-[Arrivalcircle] selected:[TTG]

[ETA]: Enter a calculated time of arrival by using a calendar/time picker.

10.4.2 Calculating a distance

The screenshot shows a dialog box titled "Voyage Calculation" with a close button (X) in the top right corner. It has two tabs: "Schedule" and "Distance", with "Distance" being the active tab. The "From" section has three radio button options: "WPT" (selected), "Pick on the route", and "Ship's position". The "WPT" option has a dropdown menu showing "1". Below "Pick on the route" is an "Edit..." button. The "Ship's position" option has a sub-label "- Via WPT" and a dropdown menu showing "0". The "To" section also has three radio button options: "WPT" (selected), "Pick on the route", and "Ship's position". The "WPT" option has a dropdown menu showing "2". Below "Pick on the route" is an "Edit..." button. At the bottom, there is a text label "Distance(Result)" and a text input field containing "2.8" followed by "NM".

1 Click on the [Distance] button.

2 Select starting point calculation method and enter a value.

Set a starting point for distance calculation by selecting [WPT] (selection of starting WPT), [Pick on the route] (selecting any position on the starting route), or [Ship's position] (selection of the own ship's position).

[WPT]: Click on a WPT used as the starting point from the combo box.

[Pick on the route]: Any position on the routes set in the starting WPT and the end WPT is used as the starting point.

When the [Edit] (editing any position) button is clicked, the color of the selectable route changes to green. When any position is clicked, that position becomes the starting point.

[Ship's position]: The own ship's position is used as the starting point.

Click on the WPT to be passed through from the [Via WPT] combo box.

3 Select an ending point calculation method and enter a value.

Set an ending point for distance calculation by selecting [WPT] (selection of ending WPT) or [Pick on the route] (selecting any position on the ending route).

[WPT]: Click on a WPT used as the ending point from the combo box.

[Pick on the route]: Any position on the routes set in the starting WPT and the end WPT is used as the end point.

When the [Edit] (editing any position) button is clicked, the color of the selectable route changes to green. When any position is clicked, that position becomes the end point.

Memo

When the [Edit] button is clicked on, the following message dialog box appears.

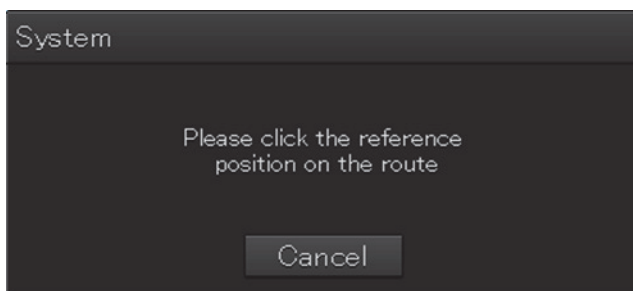

Position selection can be cancelled by clicking on the [Cancel] button.

Memo

For schedule and distance calculation, each value is calculated using CCRP as a reference point.

10.4.3 Example of distance calculation

Calculating with [WPT]

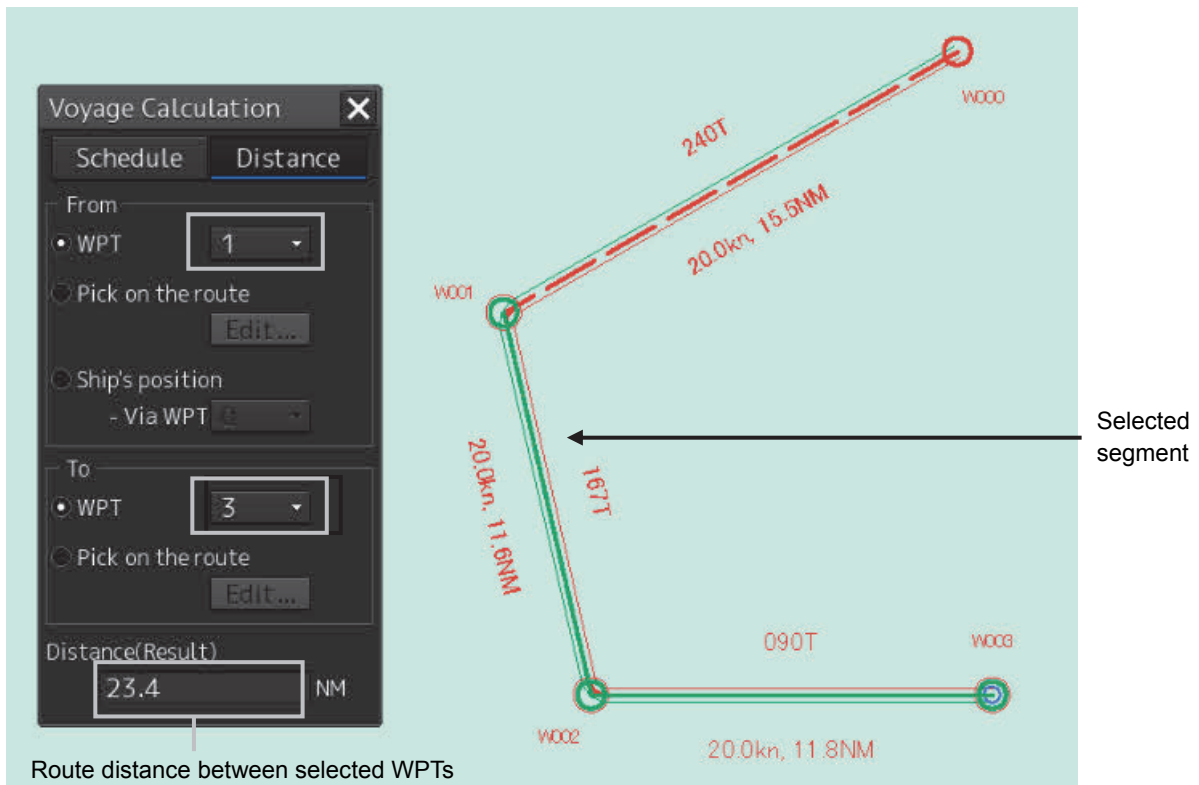

Selecting [Pick on the route] (Selecting any starting point on the route) as the starting point:

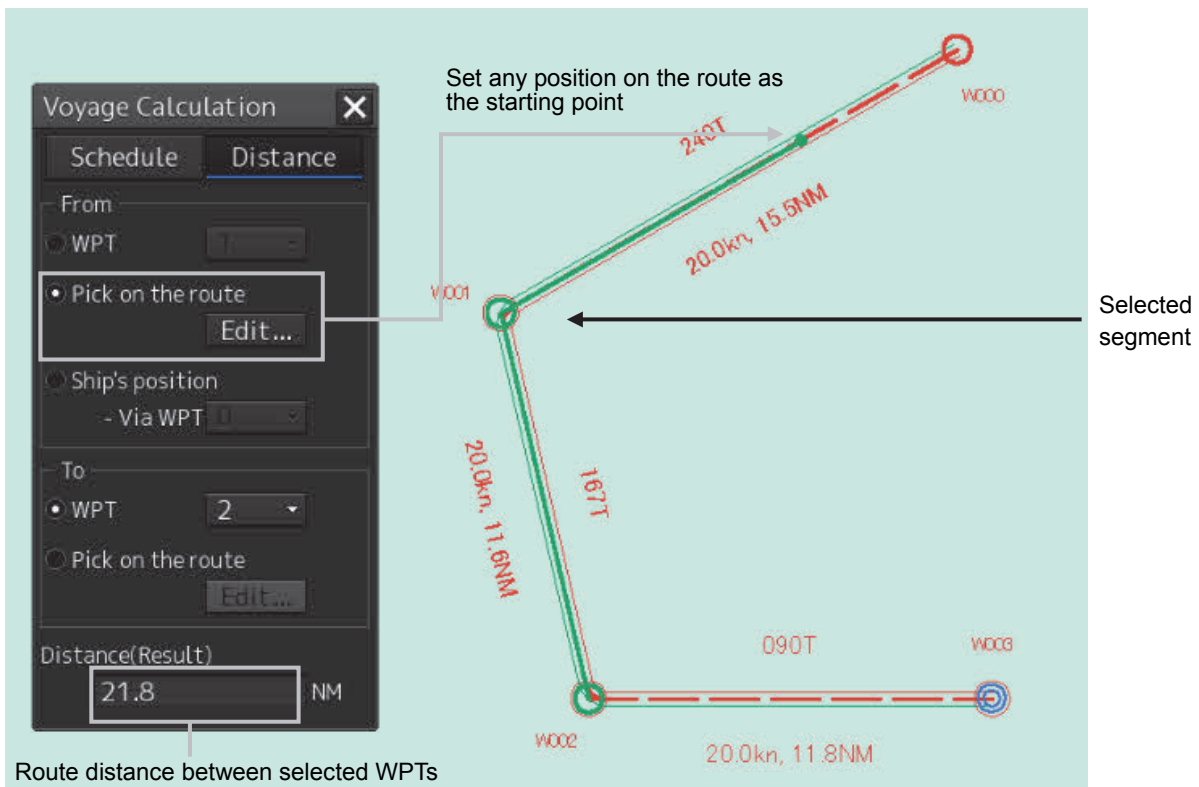

Selecting [Ship's position] (Selecting the own ship's starting position):

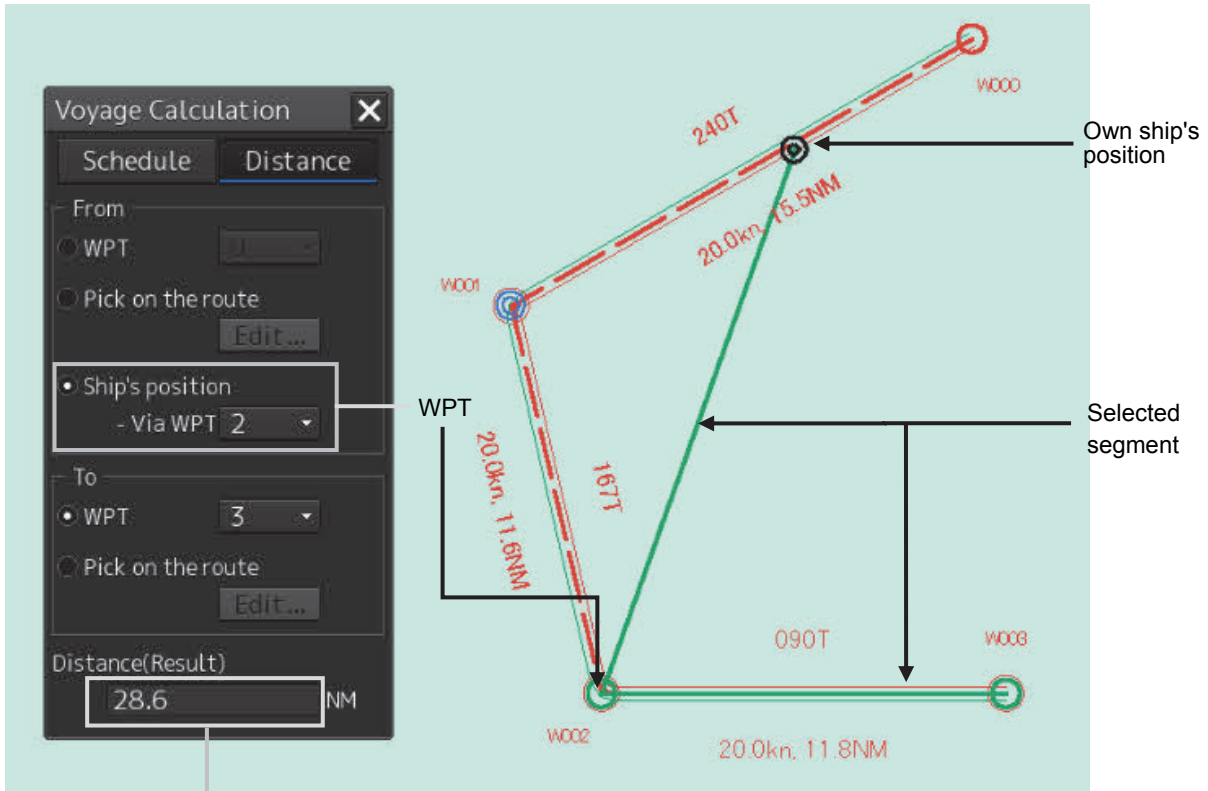

Route distance between selected WPTs

10.5 Comparing the Data between the Planned Route and the Actual Route

The [Pair of data] dialog box enables comparison of data between the planned route and the actual route.

Use the following procedure as below to open the [Pair of data] dialog box.

- 1 Click on the [Menu] button on the left toolbar.**

The menu is displayed.

- 2 Click on the [Route Monitoring] button on the menu.**

The [Route Monitoring] dialog box appears.

- 3 Click on the [Pair of data] button.**

The [Pair of data] dialog box appears.

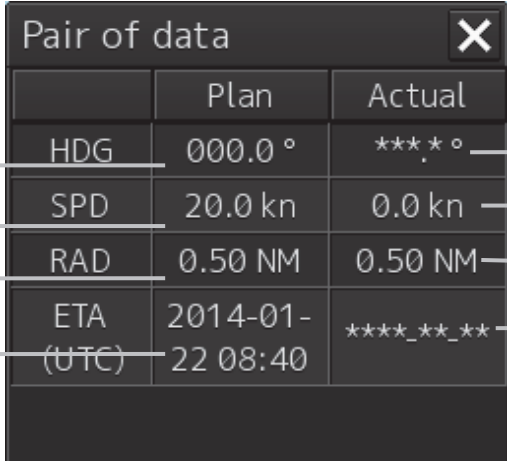

The screenshot shows a dialog box titled "Pair of data" with a close button (X) in the top right corner. The dialog box contains a table with two columns: "Plan" and "Actual". The rows are labeled on the left with [1] through [4] and on the right with [5] through [8].

	Plan	Actual	
[1]	HDG	000.0 °	[5]
[2]	SPD	20.0 kn	[6]
[3]	RAD	0.50 NM	[7]
[4]	ETA (UTC)	2014-01- 22 08:40	[8]

Planned data is displayed in [Plan] (route plan) and the actual route data is displayed in [Actual] (actual route) in the dialog.

[1] Planned course

Displays a planned course.

[2] Planned ship's speed

Displays a planned ship's speed.

[3] Planned turn radius

Displays a planned turn radius.

[4] Planned ETA

Displays a planned expected time of arrival.

[5] Actual ship's heading

Displays an actual ship's heading.

[6] Actual speed

Displays an actual ship's speed.

[7] Actual turn radius

Displays an actual turn radius.

[8] Actual ETA

Displays an expected time of arrival (ETA) that is calculated from the actual ship's speed.

10.6 Verifying Detail Information of WPT

Detail information of each WPT on the route can be verified.

Use the following procedure to display the detail information of WPT.

1 Right-click on [WPT].

The context menu is displayed.

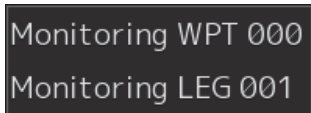

2 Click on the WPT to be verified from the context menu.

The context menu is displayed.

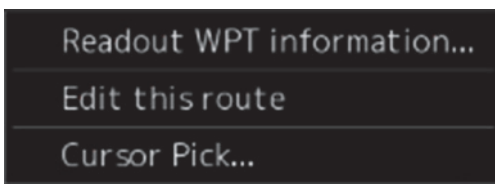

3 Click on [Readout WPT information...].

The detail information dialog of the WPT is displayed.

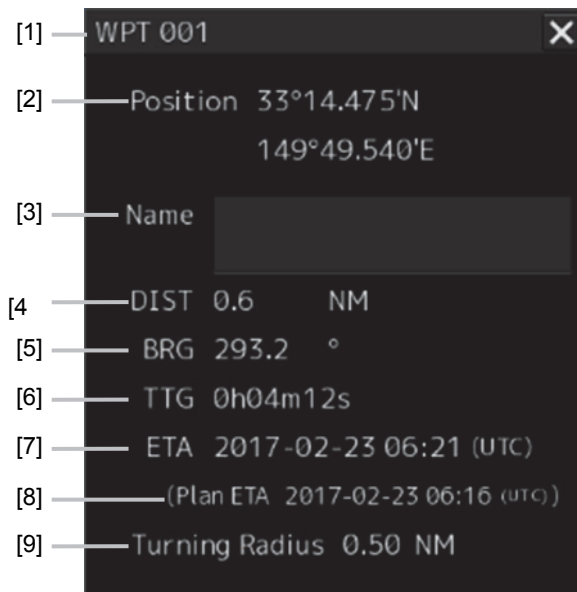

[1] WPT number

Displays a WPT number.

[2] [Position] (WPT position)

Displays the latitude/longitude of WPT.

[3] [Name] (WPT name)

Displays a WPT name.

[4] [DIST] (Distance between own ship and WPT)

Displays a distance from the own ship's position to WPT.

[5] [BRG] (Bearing between own ship and WPT)

Displays a bearing from the own ship to WPT.

[6] [TTG] (Expected time required to reach WTP)

Displays a time required to reach WPT based on the own ship's speed (SOG) and the distance.

[7] [ETA] (Expected time of arrival at WPT)

Displays an expected time of arrival at WPT based on the own ship's speed (SOG) and the distance.

[8] [Plan ETA] (Expected time of arrival at WPT)

Displays an expected time of arrival based on route planning.

[9] [Turning Radius] (Turning radius)

Displays a WPT turning radius.



Section 11 Monitoring a Dragging Anchor

Anchor Watch is a function that sets a circular or polygonal dragging anchor monitoring area around the own ship and realizes safe voyage by generating an anchor alert when a part of the outline of the own ship exceeded the monitoring area.

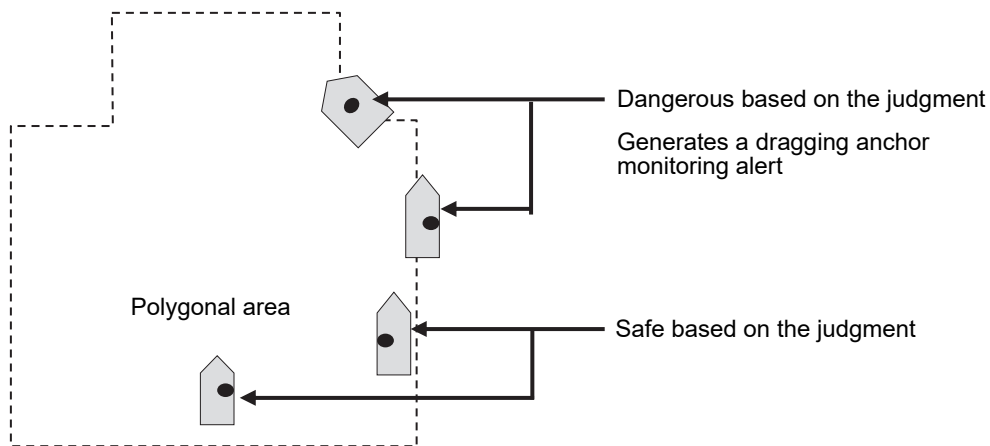
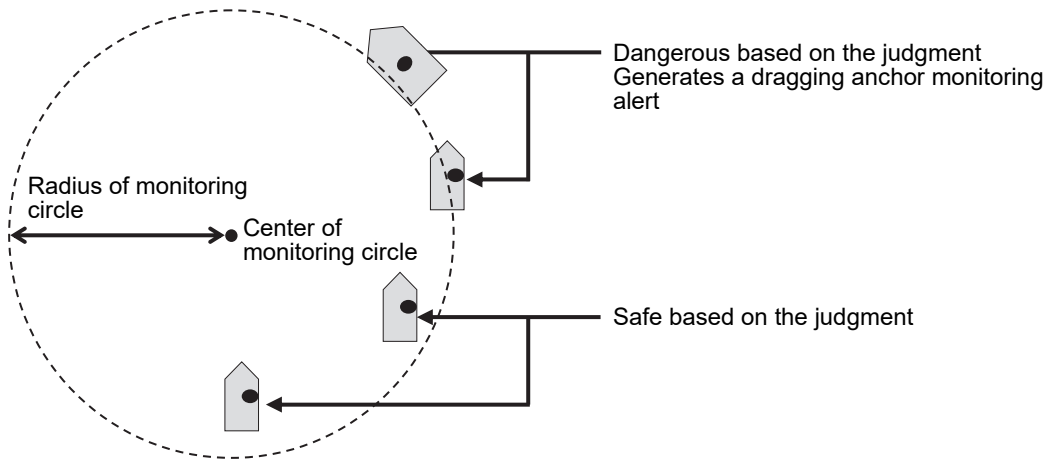

Dragging Anchor Monitoring Area

11.1 Setting a Dragging Anchor Monitoring Area

This section describes the setting of a dragging anchor monitoring area.

The setting varies depending on whether the shape of the dragging anchor area is a circle or a polygon.

11.1.1 Setting a dragging anchor monitoring circle

- 1** Click on the [Menu] button on the left toolbar.
The menu is displayed.
- 2** Click on the [Anchor Watch] button on the menu.
The [Anchor Watch] dialog box appears.
- 3** Select [Circle] from the [Mode] (dragging anchor monitoring mode selection) combo box.

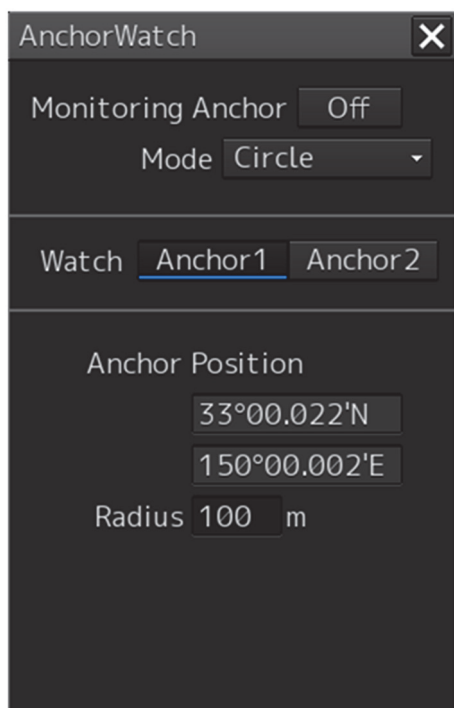

4 Select the initial position of the center position of the dragging anchor monitoring circle from the [Watch] button.

Change the initial position of the center position of the dragging anchor monitoring circle to the anchor position. The value of [Anchor 1] [Anchor 2] can be set in [Service] - [Installation] - [System Configuration] - [CCRP].

When you press the [Anchor 1] and [Anchor 2] buttons, coordinates are displayed at **[Anchor Position] (center of the dragging anchor monitoring circle).**

5 Enter the size of the dragging anchor monitoring area.

[Radius] (Radius of the dragging anchor monitoring circle)

Input range

10 to 1500 m

11.1.2 Setting a dragging anchor monitoring polygon

- 1 Click on the [Menu] button on the left toolbar.**
The menu is displayed.
- 2 Click on the [Anchor Watch] button on the menu.**
The [Anchor Watch] dialog box appears.
- 3 Select [Polygon] from the [Mode] (dragging anchor monitoring mode selection) combo box.**

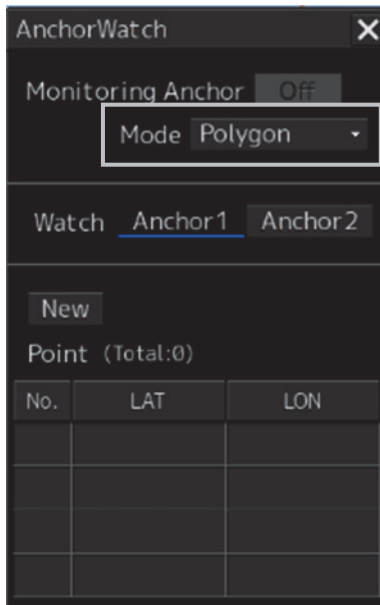

- 4 Click on the [New] button.**
The data of the [Point] (vertex) list is cleared.
- 5 Place the cursor on the chart.**
- 6 Click to determine the vertex position. Create three or more vertices to create a polygon.**
By inputting position coordinates (longitude and latitude) of the vertex position of the polygon in the [Point] list, the vertex position can be changed.
When a polygon is created, the number of vertices is displayed in [(Total:)]. Up to 360 vertices can be set.

Creation example:

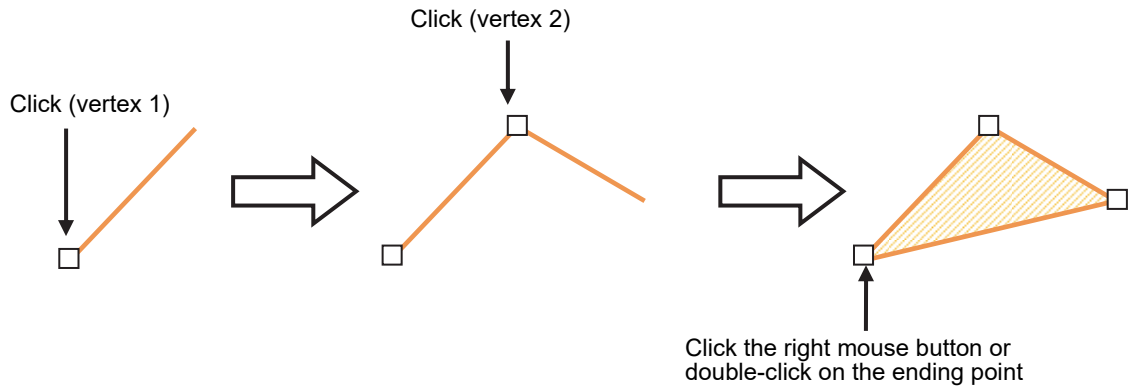

11.2 Starting and Ending Dragging Anchor Monitoring

11.2.1 Starting dragging anchor monitoring

- 1 Click on the [Menu] button on the left toolbar.
The menu is displayed.
- 2 Click on the [Anchor Watch] button on the menu.
The [Anchor Watch] dialog box appears.

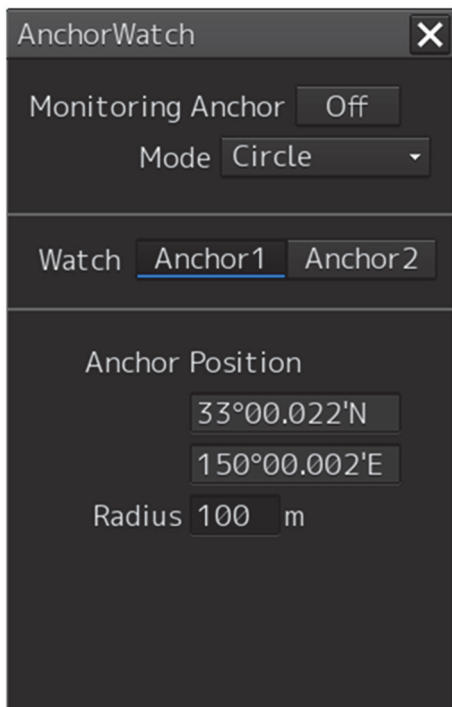

The preview of dragging anchor monitoring area that was set is displayed (broken line).

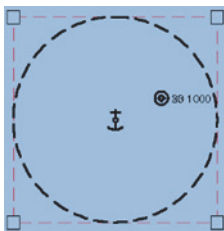

When the dialog is displayed, the anchor position is placed at the center of the circle.

3 Set dragging anchor monitoring to ON by clicking on the [Monitoring Anchor] button.

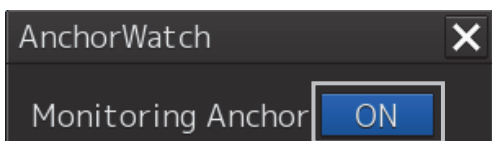

Dragging anchor monitoring starts based on the setting.

The dragging anchor monitoring area on the chart is changed to a solid line.

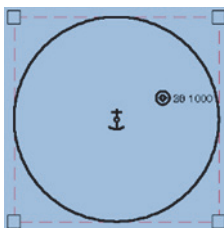

When own ship exits from the dragging anchor monitoring area, the "Outside Anchor Watch Area" warning is displayed.

Memo

"Outside Anchor Watch Area" warning escalates to "Outside Anchor Watch Area" alarm 2 minutes after own ship exits from the dragging anchor monitoring area.

11.2.2 Ending dragging anchor monitoring

Set the button display to [OFF] by clicking on the [Monitoring Anchor] button.

Alternatively, use the following procedure.

1 Click the dragging anchor monitoring circle.

A context menu is displayed.

2 Click [Finish Monitoring Anchor] on the context menu.

The [Monitoring Anchor] button display is changed to [OFF] and the display of the dragging anchor monitoring area on the chart is changed to the broken line display.

11.3 Editing/Deleting a Dragging Anchor Monitoring Area on the Chart

The size and shape of the anchor monitoring area can be changed or deleted on the chart. These operations are also available on the context menu.

These operations can be performed either before or after starting dragging anchor monitoring.

11.3.1 Changing a size of a dragging anchor monitoring circle on the chart

- 1 Click on the dragging anchor monitoring circle.

A square enclosing the dragging anchor monitoring circle is displayed.

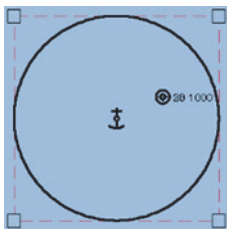

- 2 Click on any of the vertices of the square enclosing the dragging anchor monitoring circle.

The cursor changes to the arrow cursor.

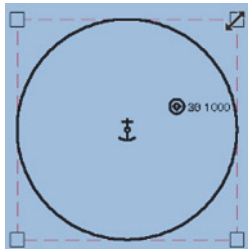

- 3 Move the cursor until the dragging anchor monitoring circle becomes a required size and click the mouse button.

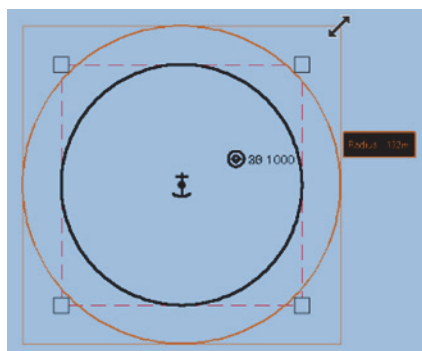

The size of the dragging anchor monitoring circle is changed.

11.3.2 Changing a size of a dragging anchor monitoring circle on the context menu

Change of a dragging anchor monitoring circle can also be executed from the context menu.

- 1 Click on the dragging anchor monitoring circle.**
A square enclosing the dragging anchor monitoring circle is displayed.
- 2 Click on any of the vertexes of the square enclosing the dragging anchor monitoring circle.**
A context menu is displayed.
- 3 Click on [Change radius] on the context menu.**
The cursor is set to the Arrow cursor.
- 4 Move the cursor until the dragging anchor monitoring circle becomes a required size and click the mouse button.**
The size of the dragging anchor monitoring circle is changed.

11.3.3 Changing a shape of a dragging anchor monitoring polygon on the chart

Changing a vertex

- 1 Click on the vertex of the dragging anchor monitoring polygon to be changed.**
The cursor is set to the Edit cursor.

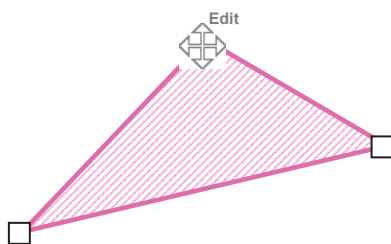

- 2 Move the cursor to the required vertex position of the dragging anchor monitoring polygon and click the mouse button.**

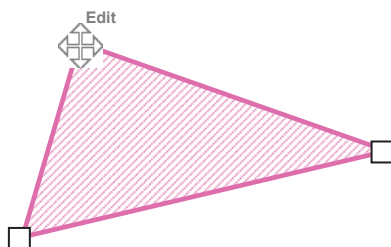

The position of the vertex is changed.

Adding a vertex

- 1 Click the mouse button on the position where a vertex to be added.

The cursor is set to the Edit cursor.

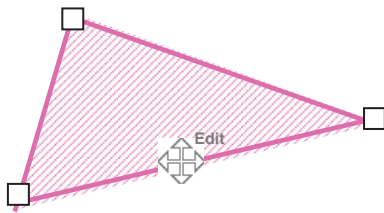

- 2 Move the cursor to the position where a vertex is to be set and click the mouse button.

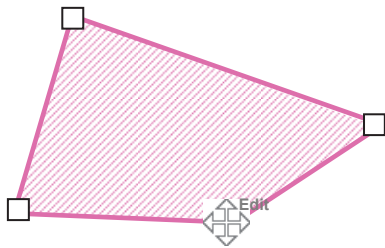

A new vertex is added.

11.3.4 Changing a shape of a dragging anchor monitoring polygon on the context menu

The following operation can be performed on the context menu that is displayed by clicking the right mouse button on the dragging anchor monitoring polygon.

[Clicking the right mouse button on the line other than vertices of the dragging anchor monitoring polygon]

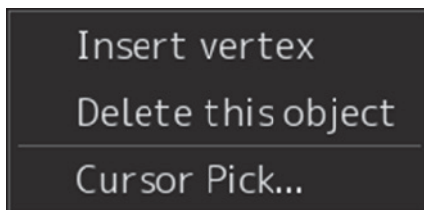

[Clicking the right mouse button on a vertex of a dragging anchor monitoring polygon]

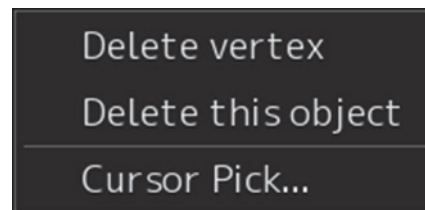

Each function is as follows.

[Insert vertex] (Addition of a vertex)

Adds a vertex at the position where the mouse button is clicked on.

[Delete vertex] (Deletion of a vertex)

Deletes the selected vertex.

[Delete this object] (Deletion of an object)

Deletes a selected dragging anchor monitoring polygon.

Note

When deletion of a dragging anchor monitoring polygon is attempted during execution of dragging anchor monitoring, the following message dialog box is displayed.

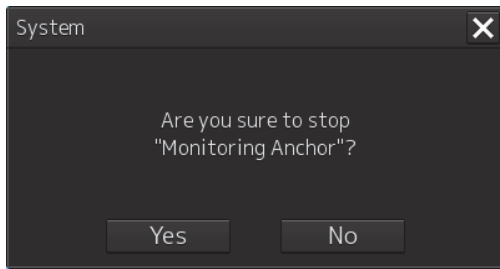

To execute deletion, click on the [Yes] button. The monitoring area is deleted and dragging anchor monitoring is terminated.

Section 12 Automatic Sailing (Option)

WARNING



When automatic sailing is performed, the operator must confirm the safety of the route and the safety at crossing of a safety contour line. Otherwise, an accident may occur.

When Auto Pilot is connected to this equipment, it is possible to calculate the course to steer from the planned route and the own ship's position and guide the ship automatically according to the planned route by outputting the course to steer to Auto Pilot.

Note

- The ECDIS screen cannot be terminated during automatic sailing.
- When MAG (Magnetic Compass) is selected as the sensor source of Heading (ship's heading), automatic sailing cannot be started.

Memo

For the details of the principle and setting of automatic sailing, refer to "18.13 Setting Automatic Sailing Parameter Values".

For the details of the Auto Pilot operation, refer to the Auto Pilot Instruction Manual.

12.1 Flow of Starting Automatic Sailing

- 1 Click on the [Menu] button on the left toolbar.**
The menu is displayed.
- 2 Click on the [Auto Sail] - [Start] on the menu.**
The automatic sailing starting wizard ([Auto Sail] dialog box) appears.

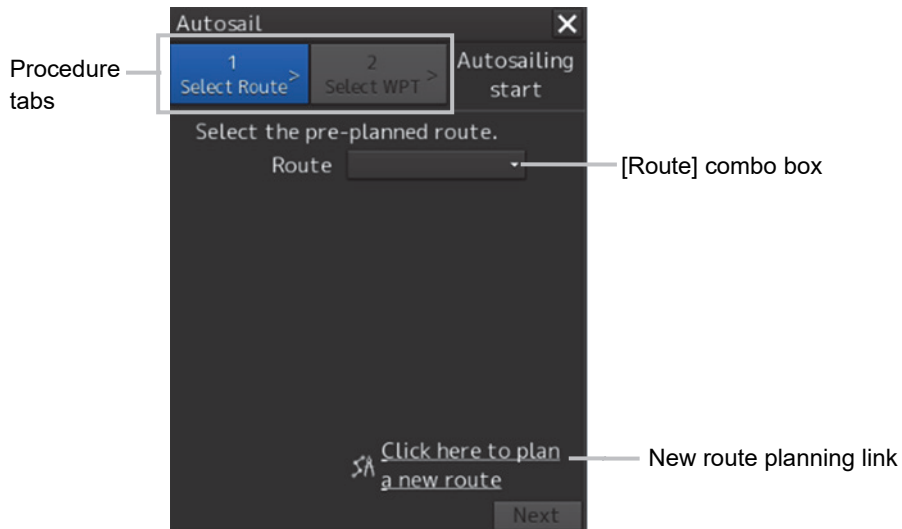

- 3 Click a planned route file to be used from the [Route] combo box of Procedure tab 1.**

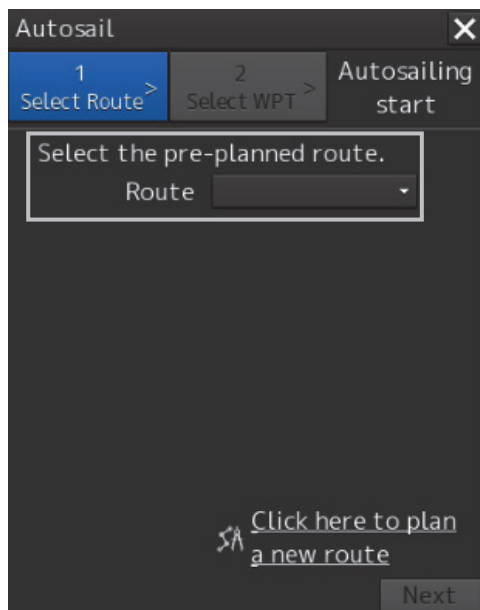

- 4 After checking a route, click on the [Next] button.**

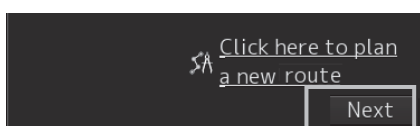

The dialog of Procedure tab 2 is displayed.

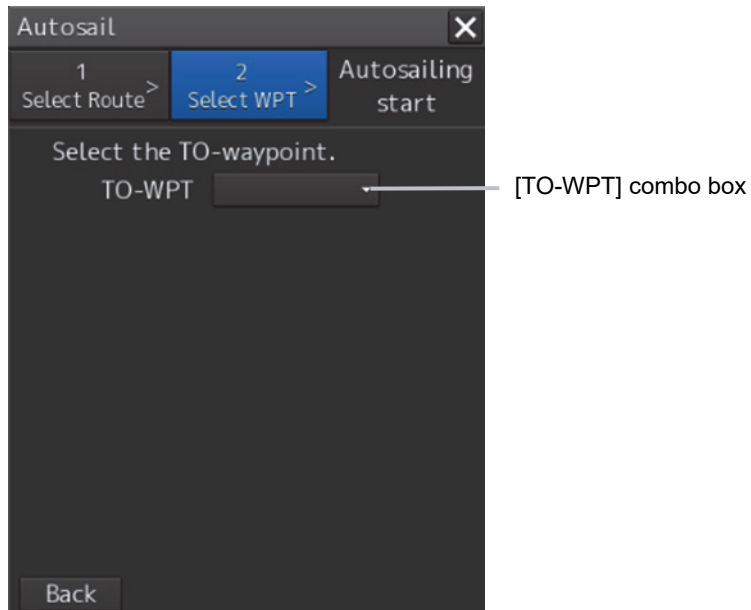

- 5 Click on the waypoint from which Auto Sail is to start from the [TO-WPT] (waypoint) combo box.

12

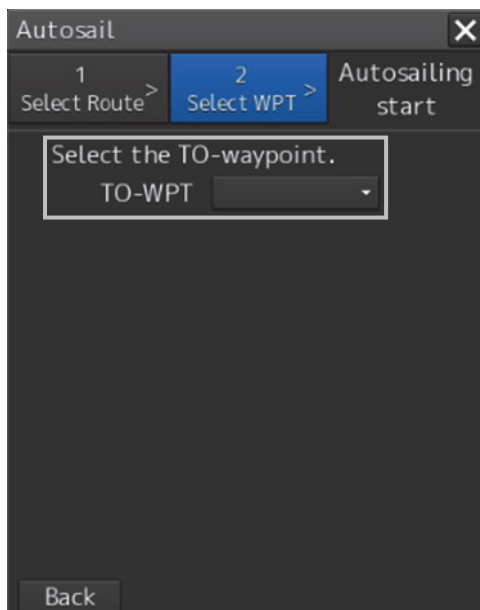

6 Start automatic sailing by clicking on the [Start] button.

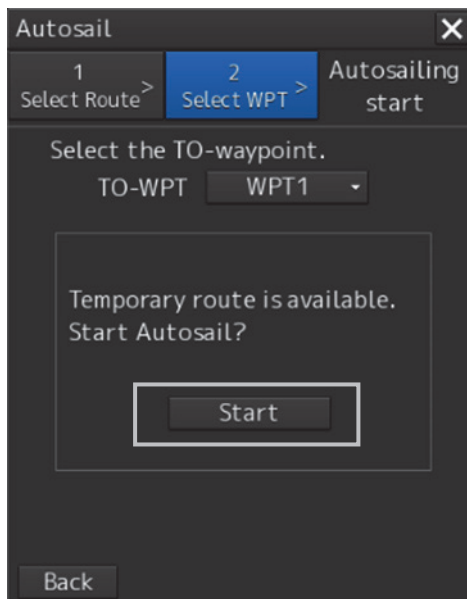

During route monitoring

During route monitoring, the name of the planned route that is currently used is displayed in the [Route] combo box.

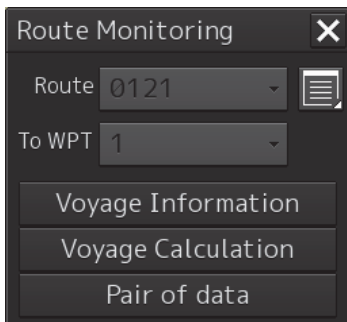

To use another planned route for automatic sailing, re-select a planned route.

Occurrence of an error

The following message dialog box appears.

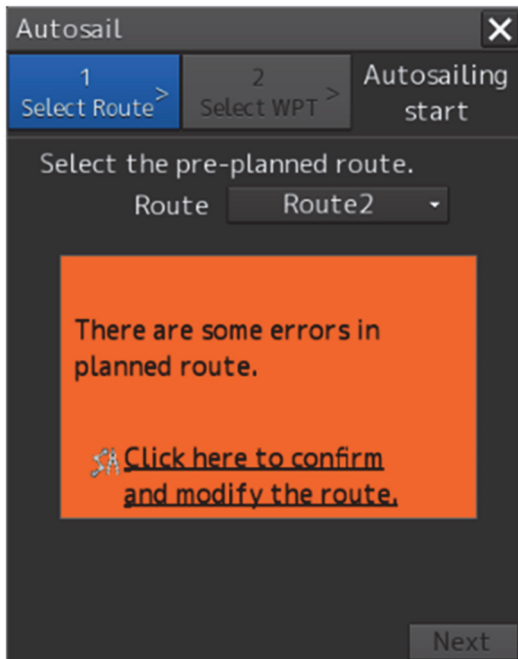

When the above error occurs, automatic sailing cannot be started.

Cancel the alert by closing the dialog box by clicking on the [X] (Close) button.

For the details of the alerts that are displayed during automatic sailing, refer to "12.6 Alerts at Automatic Sailing".

Creating a new route

- 1 Click on the [\[Click here to plan a new route\]](#) link.

The [Route Planning] dialog box appears.

For the details, refer to "12.2.2 Creating a new route".

12.2 Selecting a Route

12.2.1 Using the existing planned route

- 1 To use the existing planned track for automatic sailing, select the planned route file to be used from the [Route] combo box.

Checking of the selected route starts.

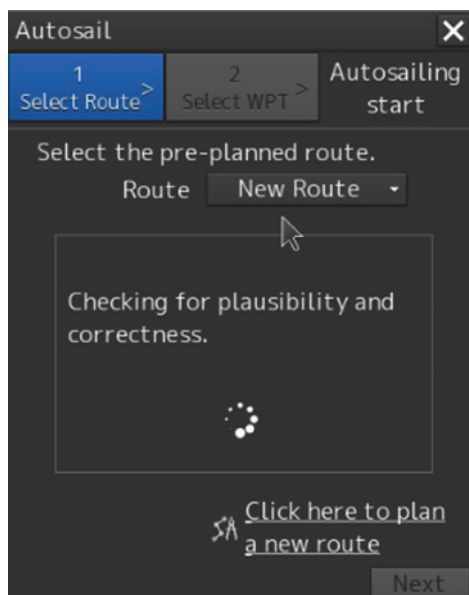

If there is no problem in the route, a route safety confirmation message is displayed and the [Next] button is enabled.

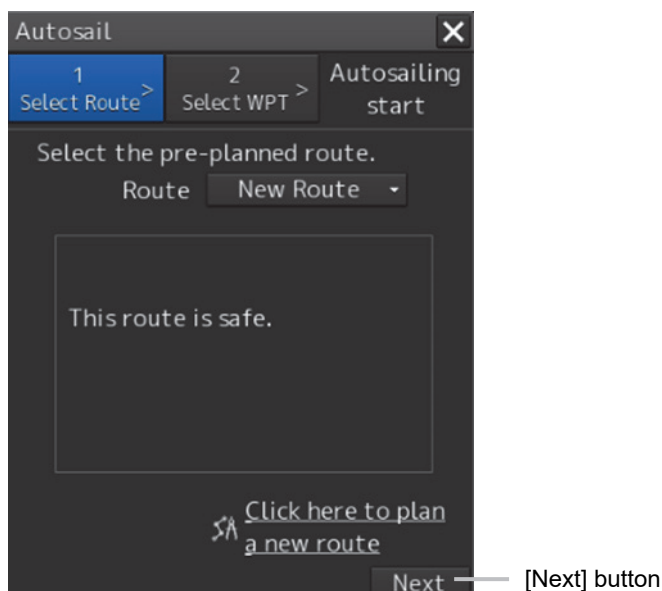

Detecting an error

When an error is detected as a result of checking the route, an error message is displayed.

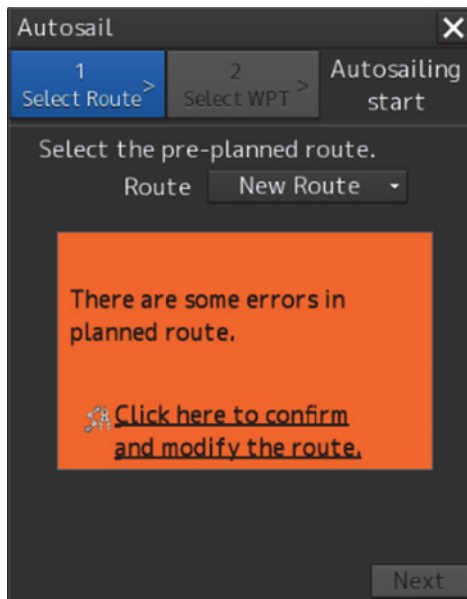

Change the route file or modify the selected route.

12

Use the following procedure for modifying a route.

- 1 Click on the [Click here to confirm and modify the route] (confirmation and modification of route) link.

The [Route Planning] dialog box is opened.

The screenshot shows the 'Route Planning' dialog box with a dark background. At the top, there is a menu bar with 'New', 'Open...', 'Save', 'Edit', and a 'Show Route Check...' button with a small blue badge containing the number '19'. Below the menu bar, there is a 'New Route' section with 'Insert', 'Delete', and 'Comment' buttons. The main area contains a table with the following columns: WPT No., Name, Position (LAT, LON), Leg (BWW, Distance), Sail, XTD (PORT, STBD), Arrival Radius, Turning Radius, Planned Speed, ROT, EIA (YYYY-MM-DD Hh:mm), Time Zone, and TWOL (Days h:mm). The table has 5 rows, with row 2 highlighted in orange.

WPT No.	Name	Position		Leg		Sail	XTD		Arrival Radius	Turning Radius	Planned Speed	ROT	EIA [YYYY-MM-DD Hh:mm]	Time Zone	TWOL [Days h:mm]
		LAT	LON	BWW	Distance		PORT	STBD							
0		32°22.104'S	00°40.815'E										2017-06-17 04:05	00:00	
1		32°22.305'S	00°45.965'E	092.6°	4.4NM	RL	0.20NM	0.20NM	0.50NM	0.50NM	20.0kn	38.2°/min	2017-06-17 04:18	00:00	00 Days 00:13
2		32°22.999'S	01°22.168'E	091.3°	30.7NM	RL	0.20NM	0.20NM	0.50NM	0.50NM	20.0kn	38.2°/min	2017-06-17 05:50	00:00	00 Days 01:32
3		32°24.035'S	01°30.765'E	098.1°	7.4NM	RL	0.20NM	0.20NM	0.50NM	0.50NM	20.0kn	38.2°/min	2017-06-17 06:13	00:00	00 Days 00:22
4		32°25.870'S	01°58.215'E	088.5°	6.3NM	RL	0.20NM	0.20NM	0.50NM	0.50NM	20.0kn	38.2°/min	2017-06-17 06:52	00:00	00 Days 00:18

When an error occurred in the planned route, a badge indicating the number of errors is displayed on the [Show Route Check...] (route checking screen display) button.



2 Click on the [Show Route Check...] button.

The [Check Route] dialog box that displays the result of the route checking appears.

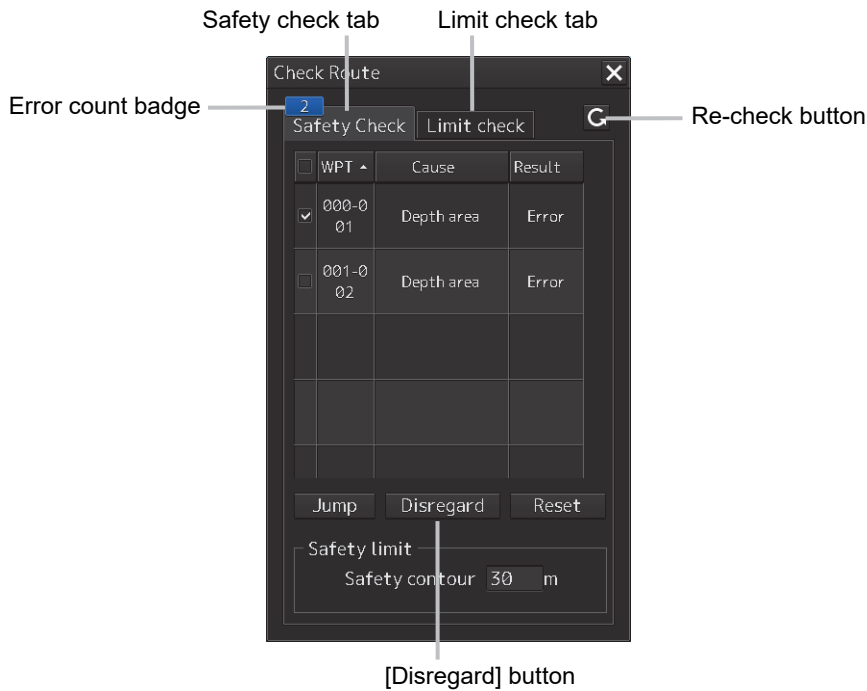

3 Modify the route, save the file by overwriting, and close the [Route Planning] dialog box.

The route safety confirmation message is displayed.

For the details of the route planning operation, refer to "Section 9 Route Planning"

12.2.2 Creating a new route

A new planned route to be used for automatic sailing can be created.

1 Click on the [Click here to plan a new route] link.

The [Route Planning] dialog box is opened.

2 Create and save a new planned route and close the [Route Planning] dialog box.

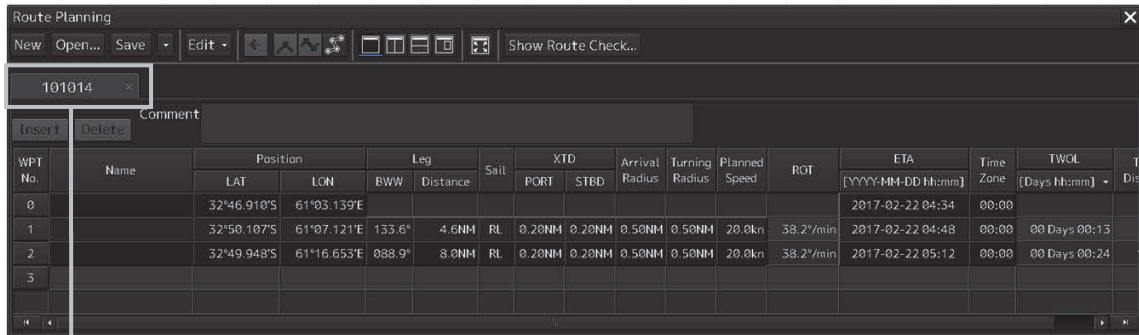

Route editing tab

For the details of "Route Planning", refer to "Section 9b Route Planning".

3 Use the newly created planned route by referring to "12.2.1 Using the existing planned route".

When the four route files have been opened

If four route files are already opened, no new edit tab can be opened unless the route edit tab that is already open is deleted once.

12.3 Selecting a Waypoint at which Automatic Sailing Starts

Select a WPT (waypoint) at which automatic sailing starts.

1 Click on Procedure tab 2.

When selecting Procedure tab 1, click on the [Next] button.

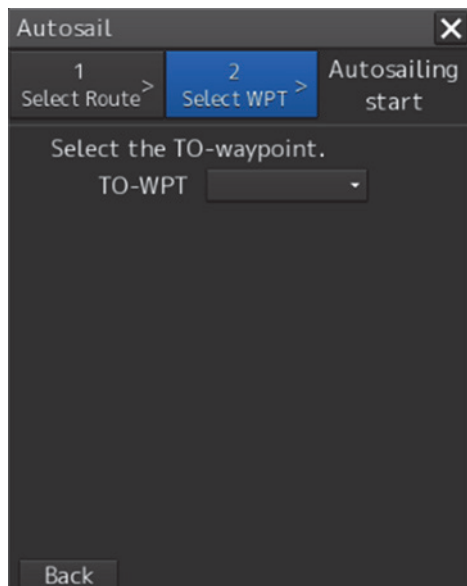

When the [Back] button is clicked on, control returns to the route selection screen, enabling re-selection of a route.

2 Click on the waypoint at which automatic sailing starts from the [TO-WPT] combo box.

Note

When the [Auto Sail] dialog box is activated during route monitoring, WPT that has been passed through cannot be selected.

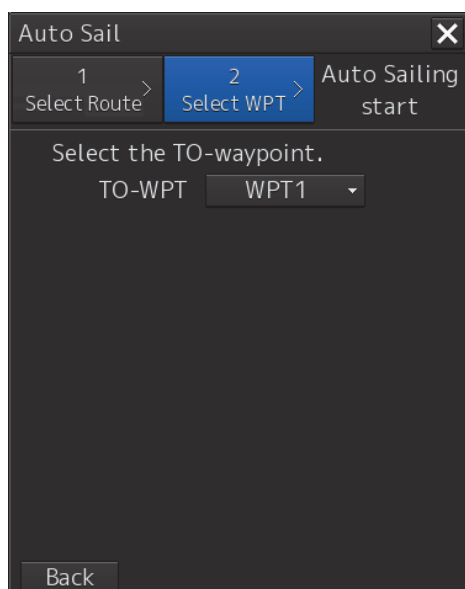

Creation of the temporary route to the selected WPT starts.

When the temporary route is created, a completion message and the [Start] button are displayed.

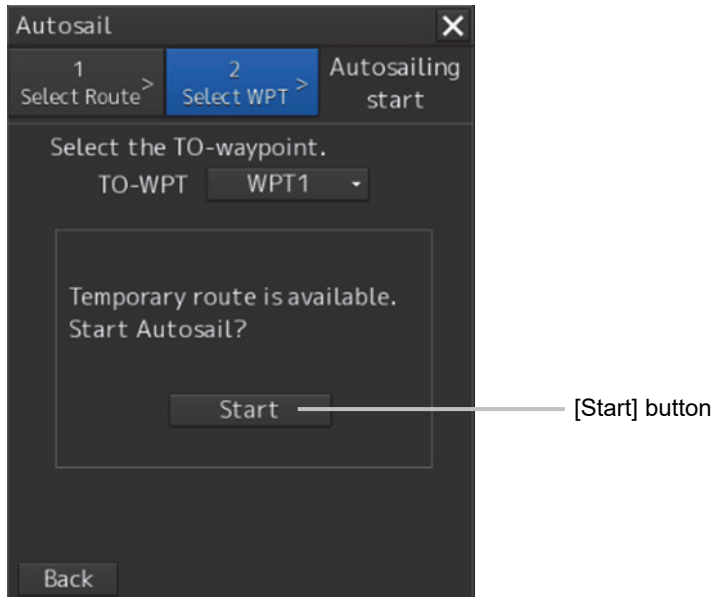

When a temporary route cannot be created, the following error message is displayed.

Error message	Cause	Measures
Cannot create the temporary route because the course is inappropriate. Turn the course toward the planned course.	The temporary route could not be created due to the inappropriate course.	Approximate the ship's heading to the planned route.
Cannot create the temporary route because the XTD exceed XTD MAX. Move own ship toward the planned route.	Since XTD is too large, the temporary route could not be created.	Approximate own ship to the planned route.
Cannot create the temporary route because own ship may pass through the WOL. Select the TO-Waypoint again.	Since own ship may pass through the WOL, the temporary route could not be created.	Re-select TO-WPT.
Cannot create the temporary route because own ship may pass through the planned route leg. Select the TO-Waypoint again.	Since own ship may pass through the planned route leg, the temporary route could not be created.	Re-select TO-WPT.

Memo
 Even if the predicted route creation starting condition processing fails, the predicted route is drawn.

12.4 Starting Automatic Sailing

WARNING



If your ship has reached a veering circle during the automatic navigation, make sure that the safety check and veering operation are made by the ship operator himself.

If veering operation is not made, regression bearing will be maintained without veering. This may cause an accident.



Input the ship's parameter accurately according to the specification of the ship.

Otherwise, accidents may result.

CAUTION



Do not neglect confirmation of the position and the bearing of own ship during sailing regardless of whether automatic sailing is set to ON or OFF.

Otherwise, an accident may occur.

- 1 Click on the [Start] button of Procedure tab 2.

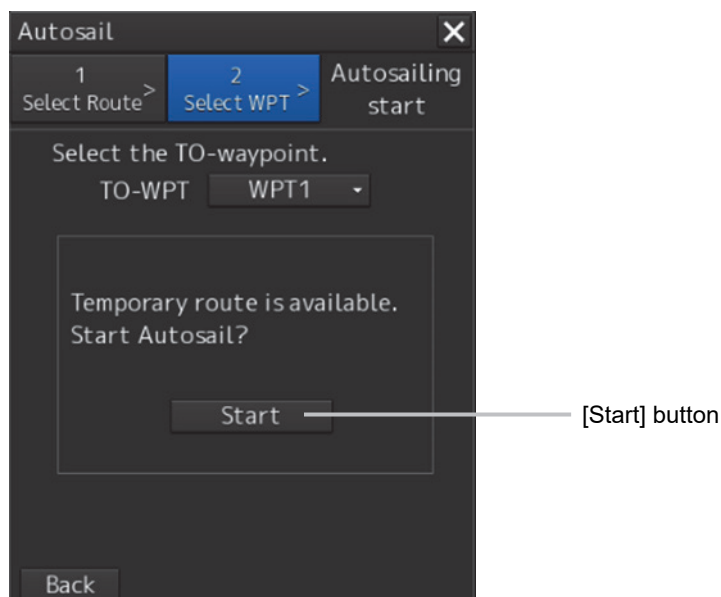

The [Auto Sail] dialog box is closed and the Autopilot steering mode switching message is displayed. Switch the Autopilot steering mode to the NAVI mode.



The selected planned route is displayed on the chart and the [Voyage Information] dialog is displayed.

When the [Route Planning] dialog box is opened during automatic sailing, the [Auto Sailing] (during automatic sailing) indicator is displayed on the tab of the planned route that is currently used.

The Route Planning dialog box shows a table with the following data:

WPT No.	Name	Position		Leg		Sail	XTD		Arrival		Turning Radius	Planned Speed	ROT	ETA [YYYY-MM-DD hh:mm]	Time Zone	TWOL [Days hh:mm]	Dist
		LAT	LOn	BWV	Distance		PORT	STBD	Radius	Radius							
0		52°07.416'S	61°04.807'E											2017-07-13 13:50	00:00		
1		31°59.485'S	61°04.818'E	000.1°	7.9NM	RL	0.20NM	0.20NM	0.50NM	0.50NM	20.0kn	38.2°/min		2017-07-13 14:13	00:00	00 Days 00:23	
2		31°51.319'S	61°04.859'E	000.2°	8.2NM	RL	0.20NM	0.20NM	0.50NM	0.50NM	20.0kn	38.2°/min		2017-07-13 14:38	00:00	00 Days 00:24	
3																	

[Auto Sailing] indicator

12.5 Stopping Automatic Sailing

- 1 Click on the [Autosail] tab of the [Voyage Information] dialog and click on the [Track Control Stop] button.

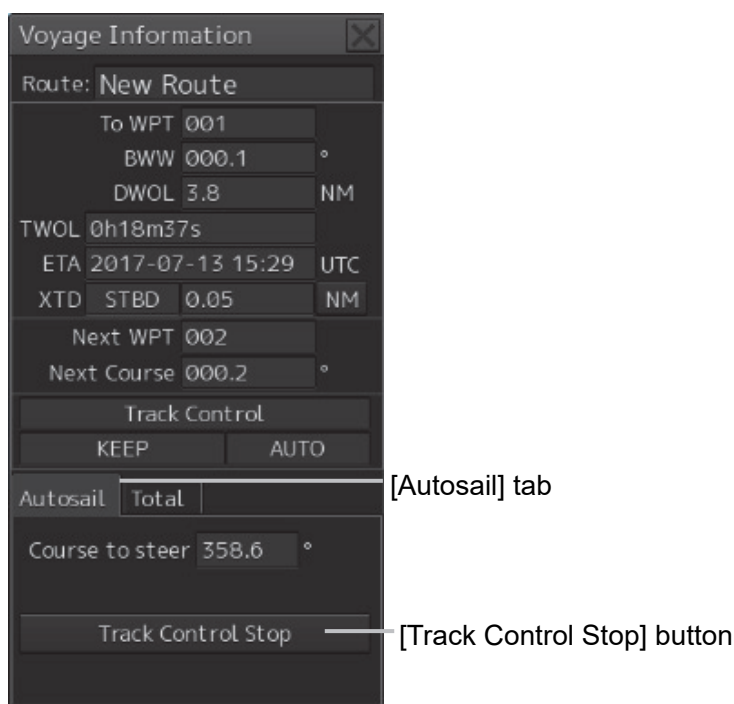

The automatic sailing stopping confirmation dialog box appears.

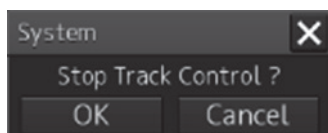

- 2 Click on the [OK] button.

Automatic sailing stops.

By the auto pilot that is installed, the auto pilot steering mode switching confirmation dialog is displayed or the mode is automatically changed to another steering mode.

For the details, refer to the Auto Pilot Instruction Manual.

12.6 Alerts at Automatic Sailing

The following sailing monitoring alerts may occur during automatic sailing.

Cause	Conditions to raise	Automatic sailing	Countermeasure
Course difference warning	The actual heading deviated from the course beyond a preset course difference limit.	Can be continued	-
Cross Track alarm	The ship deviated from the track beyond a preset cross-track limit during the track control.	Can be continued	-
HDG(Sensor Failure) alarm	Heading sensor data is lost or invalid during the track control.	Stops	Switch the steering mode of AUTO PILOT to HAND. Otherwise, the current rudder angle is retained for AUTO PILOT (for details, refer to the AUTO PILOT instruction manual).
POSN(Sensor Failure) alarm	Position sensor data was lost or invalid during the track control.	Performs dead reckoning for 10 minutes and stops automatic sailing.	Switch the steering mode of AUTO PILOT to AUTO or HAND. Otherwise, the current course is retained for AUTO PILOT (for details, refer to the AUTO PILOT instruction manual).
STW(Sensor Failure) alarm	Speed sensor data is lost or invalid during the track control.	Performs dead reckoning using the last received speed value.	
POSN(Automatic Changed) warning	POSN source was automatically changed.	Can be continued	-
STW(Automatic Changed) warning	STW source was automatically changed	Can be continued	-
POSN(Deviation) warning	Deviation between position source exceeded beyond a preset POSN Discrepancy limit.	Can be continued	-
Lost AP caution	A communication error occurred between Autopilot and ECDIS	Stops	Switch the steering mode of AUTO PILOT to AUTO or HAND. Otherwise, the current course is retained for AUTO PILOT (for details, refer to the AUTO PILOT instruction manual).
	An Autopilot failure occurred.		Switch the steering mode of AUTO PILOT to AUTO or HAND. Otherwise, the current rudder angle is retained for AUTO PILOT (for details, refer to the AUTO PILOT instruction manual).

Cause	Conditions to raise	Automatic sailing	Countermeasure
Early Course Change warning	3-6 minutes before the wheel-over time. If Early course change warning is not acknowledged for 30 seconds, the warning escalates to Early course change alarm.	Can be continued	-
Early course change alarm	An early course change warning was not acknowledged for 30 seconds. If the alarm is not acknowledged for an extra period of 30 seconds, Back-up Navigator Call is transferred to BNWAS.		
Actual Course Change warning	30 s before the wheel-over time. If Actual course change warning is not acknowledged for 30 seconds, the warning escalates to Wheel-over Time alarm.	Can be continued	-
Wheel Over Line alarm	An actual course change warning was not acknowledged for 30 seconds. If the alarm is not acknowledged for an extra period of 30 seconds, Back-up Navigator Call is transferred to BNWAS.		
Change Autopilot steering mode warning	Position or speed sensor data is lost or invalid, causing the following errors: POSN(Sensor Failure) alarm STW(Sensor Failure) alarm Even if the warning is acknowledged, this warning will be repeated every 2 minutes during dead reckoning.	Performs dead reckoning for 10 minutes and stops automatic sailing.	Switch the steering mode of AUTO PILOT to AUTO or HAND. Otherwise, the current course is retained for AUTO PILOT (for details, refer to the AUTO PILOT instruction manual).
		Performs dead reckoning using the last received speed value.	

Cause	Conditions to raise	Automatic sailing	Countermeasure
End Of Track warning	3-6 minutes before the arrival at final WP. If End Of Track warning is not acknowledged for 30 seconds, the warning escalates to Arrived at LAST WPT alarm.	Stops automatic sailing after passing the final destination.	After passing the final destination, switch the steering mode of AUTO PILOT to AUTO or HAND. Otherwise, the current course is retained for AUTO PILOT (for details, refer to the AUTO PILOT instruction manual).
Arrived at LAST WPT alarm	An End Of Track warning was not acknowledged for 30s seconds. If the alarm is not acknowledged for an extra period of 30 seconds, Back-up Navigator Call is transferred to BNWAS.		
Track Control Stopped warning	After 10 minutes of DR sailing following the occurrence of POSN(Sensor Failure)	Performs dead reckoning for 10 minutes and stops automatic sailing.	Switch the steering mode of AUTO PILOT to AUTO or HAND. Otherwise, the current course is retained for AUTO PILOT (for details, refer to the AUTO PILOT instruction manual).
	HDG(Sensor Failure) occurred.	Stops	Switch the steering mode of AUTO PILOT to HAND. Otherwise, the current rudder angle is retained for AUTO PILOT (for details, refer to the AUTO PILOT instruction manual).
	An autopilot failure or a communication error occurred between Autopilot and ECDIS, causing the following errors: Lost AP caution	Stops	Switch the steering mode of AUTO PILOT to AUTO or HAND. Otherwise, the current course is retained for AUTO PILOT (for details, refer to the AUTO PILOT instruction manual).
Track Control Stopped alarm	A Track Control Stopped warning was not acknowledged for 30 seconds. If the alarm is not acknowledged for an extra period of 30 seconds, Back-up Navigator Call is transferred to BNWAS.	Stops	Switch the steering mode of AUTO PILOT to AUTO or HAND. Otherwise, the current course is retained for AUTO PILOT (for details, refer to the AUTO PILOT instruction manual).
Track Control Stopped (Reboot) alarm	Equipment restarted during the track control.		

Type	Occurring condition	Automatic sailing	Countermeasure
POSN(Jump) caution	Position is jumped beyond a DR position (preset Radius limit).	Stop	Change the auto pilot steering mode to Manual.
HDG(Unmatched Source) caution	The primary HDG sensor used by ECDIS is not the same as the primary HDG sensor used by Autopilot.	Can not start the track control	Make the primary HDG used by the autopilot and ECDIS the same.

Section 13 Operating a Chart (option)

Use the [Chart] menu for chart operations.

- 1 Click on the [Menu] button on the left toolbar.

The menu is displayed

- 2 Click on the [Chart Settings] button on the menu.

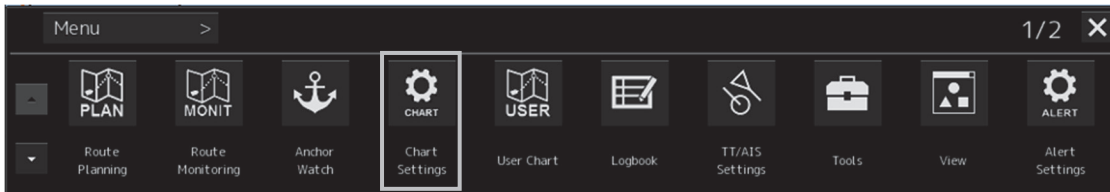

The submenu is displayed.



It is possible using the page switching buttons to switch to the first page and the second page of the submenu screen.

Click each button of the submenu screen to display the relevant function dialog.

Button name	Function	Related section	Target
First page			
Manual Update	Updates a chart manually	13.1 Updating a Chart Manually	ECDIS, CHART RADAR
My Port List	Operates a port name list	8.7 Registering and Displaying My Port List	ECDIS
Update Review	Selects an S-57 chart	13.2 Displaying/Searching an S-57 Chart [Select S-57 Chart]	
Off Center by Entering Position	Moves the display center	13.3 Displaying a Chart by Inputting a Position	
Accept S-57 Updates	Accepts the updated S-57 chart	13.4 Confirming/Accepting/Rejecting an S-57 Updated Chart	
Date-dependent View	Displays a date-dependent object	13.5 Displaying a Date-dependent Object	
Graphical Index	Displays a chart boundary	13.6 Displaying a Chart Boundary	
Chart Abbreviation	Chart abbreviation	13.9 Displaying a Chart Abbreviation List	

Button name	Function	Related section
Second page		
T & P (ARCS)	Enables verification of temporary/preliminary information of the ARCS chart	13.7 Confirming Temporary/Preliminary Information of an ARCS Chart
Datum Offset (ARCS)	Offsets ARCS chart data	13.8 Adjusting an ARCS Chart Position
Datum Transformation (ARCS)	Transforms any position of the ARCS chart and geodetic datum of the own ship's position to those of the WGS-84	13.8.2 Transforming a geodetic datum of an ARCS chart to WGS-84
ENC Update Status Report	Displays the Latest report of SENC within the system.	13.10 Displaying an ENC Update Status Report
Check Applied C-MAP Updates	Displays update data of the C-MAP chart.	13.11 Displaying update data of the C-MAP chart
Show C-MAP Licence Information	Displays C-MAP license information.	13.12 Displaying license information of C-MAP
ECDIS Chart 1	Displays ECDIS Chart 1	13.13 Displaying ECDIS Chart 1

13.1 Updating a Chart Manually

The chart can be updated manually by selecting [Chart] - [Manual Update] (chart manual update) on the menu.

For the details of manual update of a chart, refer to "14.3 Updating a Chart Manually (ARCS) (ECDIS Screen Only)".

13.2 Displaying/Searching an S-57 Chart [Select S-57 Chart]

13.2.1 Displaying a chart

Select S-57 Chart enables selection and display of any chart.

- 1 Click on the [Menu] button on the left toolbar.**

The menu is displayed

- 2 Click on the [Chart] - [Select S-57 Chart] on the menu.**

The [Select Chart] dialog box appears.

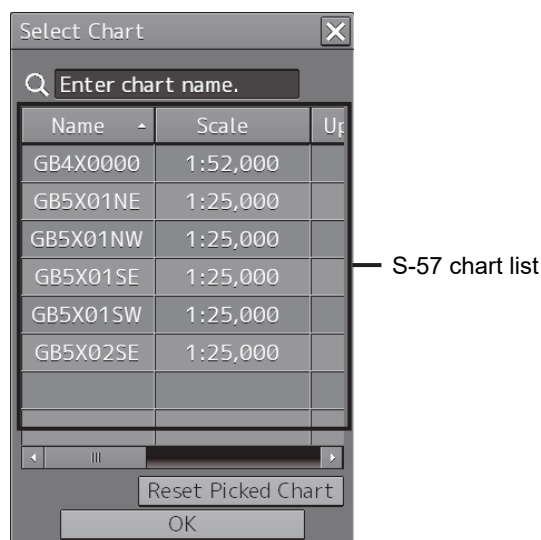

An S-57 chart list contains chart names (Name), original scales (Scale), Updating numbers (Up No.), issuing dates (Issue date), last update dates (Last Update), update acceptance statuses (Accepted, Yes: Accepted/No: Not accepted) and Rejected (update rejection status, Yes: Rejected/No: Not rejected)).

- 3 Click on the line of the chart to be displayed from the S-57 chart list.**

The chart is selected.

- 4 Click on the [OK] button.**

The selected chart is displayed on the screen.

13.2.2 Search a chart

13.2.2.1 Searching the position that is clicked on by the cursor

- 1 Click on the [Menu] button on the left toolbar.

The menu is displayed

- 2 Click on the [Chart] - [Select S-57 Chart] on the menu.

The [Select Chart] dialog box appears.

- 3 Move the cursor to the position to be searched and click the mouse button.

The chart that is set at the position specified by clicking the mouse button is displayed in the S-57 chart list.

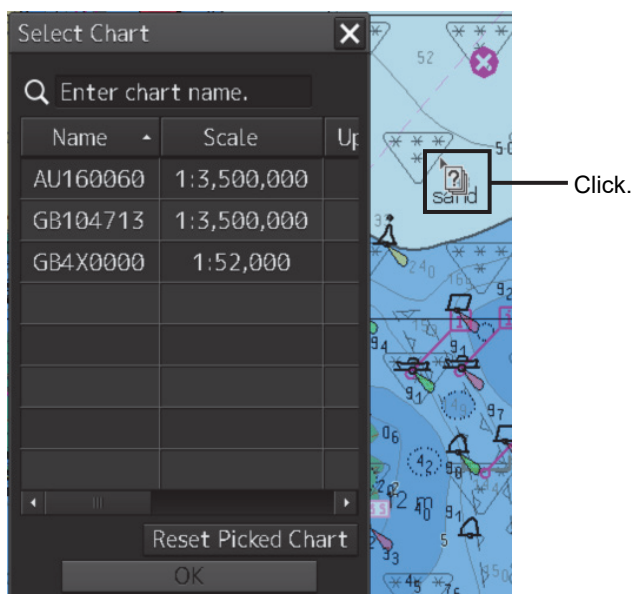

Clearing search results

Click on the [Reset Picked Chart] (chart selection reset) button.

13.2.2.2 Searching by using a chart name

- 1 Click on the [Menu] button on the left toolbar.**
The menu is displayed
- 2 Click on the [Chart] - [Select S-57 Chart] on the menu.**
The [Select Chart] dialog box appears.
- 3 Enter a chart name in the search box**

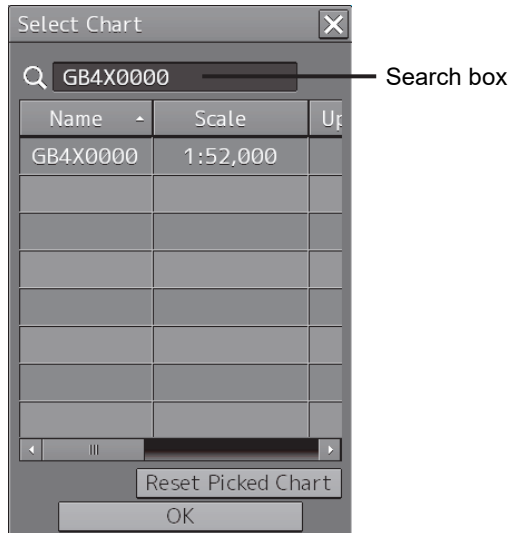

The chart is displayed.

Clearing search results

Clear by using the [DEL] key on the software keyboard.

13.3 Displaying a Chart by Inputting a Position

By inputting a position, the chart of the position that was input can be displayed.

- 1 Click on the [Menu] button on the left toolbar.**

The menu is displayed

- 2 Click on the [Chart] - [Off Center by Entering Position] on the menu.**

The [Off Center by Entering Position] dialog box appears.

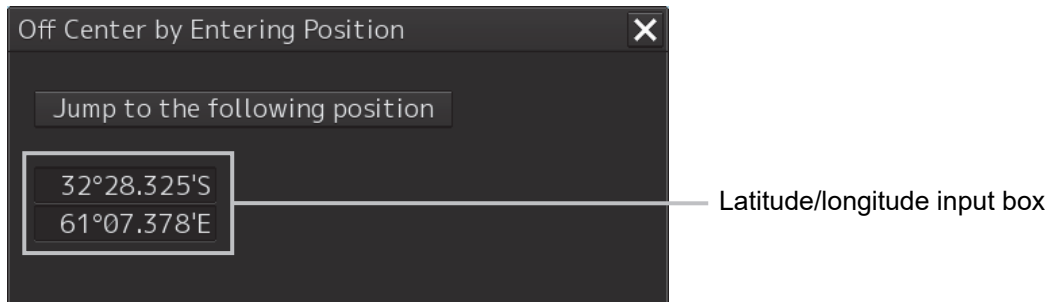

- 3 Enter a position of the chart to be displayed in the latitude/longitude input box.**

- 4 Click on the [Jump to the Following Position] button.**

The chart of the specified position is displayed.

4 Click on the [Accept] button to accept the updated chart.

The updated chart is integrated into the original chart.

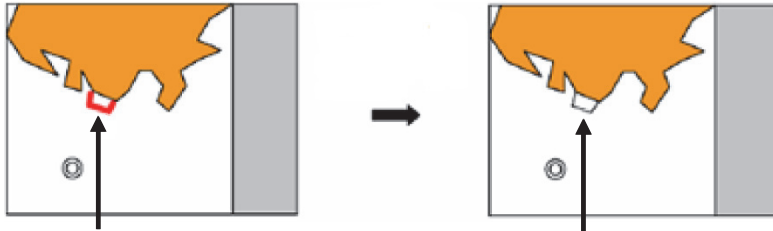

Click on the [Show] button:
A highlight marker is displayed
on the object to be updated.

Click on the [Accept] button:
The object is accepted and only
the updated object is displayed.

For the details of the highlight indication, refer to 13.14 Displaying differences at chart update.

5 To reset the updated chart to the pre-update state, select two or more target charts from the list and click on the [Reject] button.

When the [Reject] button is clicked on, the automatic update of the chart is rejected and the chart is reset to the pre-update state.

After the Reject operation, a rejection marker is displayed on the target object.

For the details of the rejection indication, refer to 13.14 Displaying differences at chart update.

13.5 Displaying a Date-dependent Object

A chart object of the specified date and time can be displayed.

For instance, it is possible to display a date-dependent chart such as displaying a chart at the arrival time of the arrival schedule at the navigation planning.

- 1 Click on the [Menu] button on the left toolbar.**

The menu is displayed

- 2 Click on the [Chart] - [Date-dependent View] on the menu.**

The [Date-dependent View] dialog box appears.

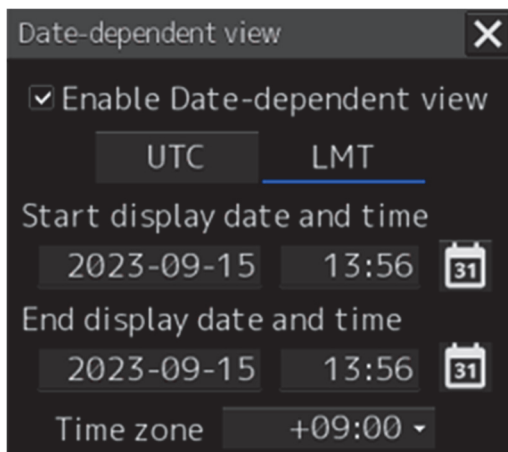

- 3 Set the [Enable Date-dependent View] check box to ON.**

If the screen is closed while the check box is set to OFF, the date-dependent object is not displayed.

- 4 Set the [UTC] (Universal Time Coordinated) button or [LMT] (Local Mean Time) button to On by clicking on the button.**

- 5 Enter a date (within the range from 1980-01-01 to 2099-12-31) and a time in the [Start display date and time] input box.**

- 6 Enter a date (within the range from 1980-01-01 to 2099-12-31) and a time in the [End display date and time] input box.**

- 7 When [LMT] is set to On in Step 4, enter a time difference in [Time Zone] box within the range from -13:30 to +13:30.**

The object displayed on the chart is updated when information is input in any of the steps from Step 5 to Step 7.

- 8 Close the [Date-dependent View] dialog box.**

Displaying the Permanent Information in duration specification

When the duration specification of the object is different from the current date while a date-dependent object is displayed, Viewing Does Not Include Current Date is displayed in Permanent Information. When the duration specification matches the current date, this message is not displayed since no warning is necessary.



Viewing Does Not Include Current Date

In the specified date and time, (UTC) is displayed for (LMT) under UTC and the Time Zone is not specified.

For duration specification for a route plan by ETA, the duration is always displayed under UTC.

When a route plan is displayed, the Date-dependent View screen is closed and Date-dependent View on the menu is set to Disable. (This is because the priority is given to the duration specification for a route plan by ETA.)

Note

While displaying a route in a route plan, Viewing Does Not Include Current Date is displayed in Permanent Information if the specified duration is different from the current date.

13.6 Displaying a Chart Boundary

The boundary of the chart on the position on which the button was clicked is displayed.

13.6.1 Setting a boundary to be displayed on the chart

A chart boundary can be displayed.

1 Click on the [Menu] button on the left toolbar.

The menu is displayed.

2 Click on the [Chart] - [Graphical Index] on the menu.

The [Graphical Index] dialog box appears.

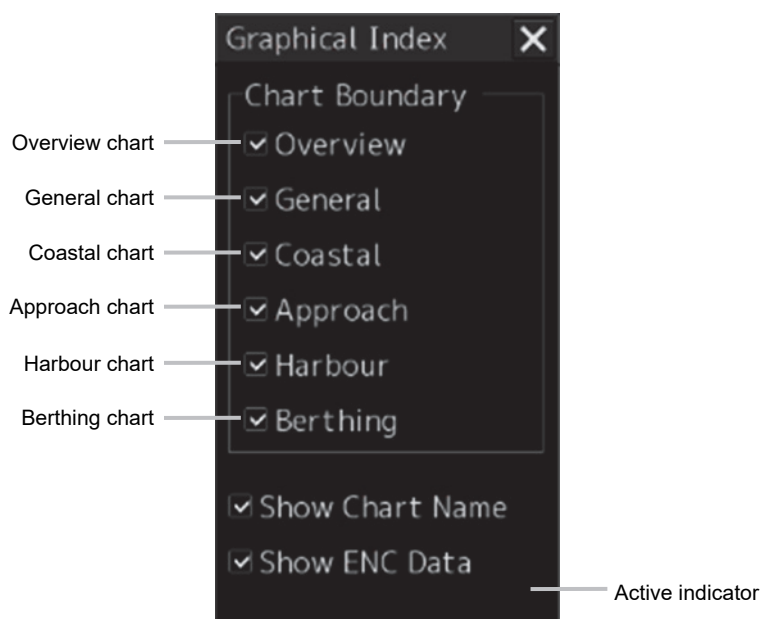

3 Select the chart whose boundary is to be displayed among the [Chart Boundary] check boxes.

4 To display the chart name in addition to the boundary, select [Show Chart Name].

5 To display ordinary chart information in addition to the boundary, select [Show ENC Data] (displaying chart information).

When this item is not selected, the background chart is displayed.

Memo

While C-MAP is displayed, [Show ENC Data] is not displayed.

Active indicator ()

Although the operation of each check box is enabled while the active indicator is displayed, a chart boundary line is not displayed.

When the active indicator is hidden, a boundary line is displayed.

13.6.2 Displaying chart information

When the chart is clicked on while the [Graphical Index] dialog box is displayed, the chart information on the location that was clicked on is displayed in "Edition and date of chart".

Memo

"Edition and date of chart" is not displayed while the active indicator is displayed in the [Graphical Index] dialog box even if the chart is clicked on.

Information of the chart of the location that was clicked on

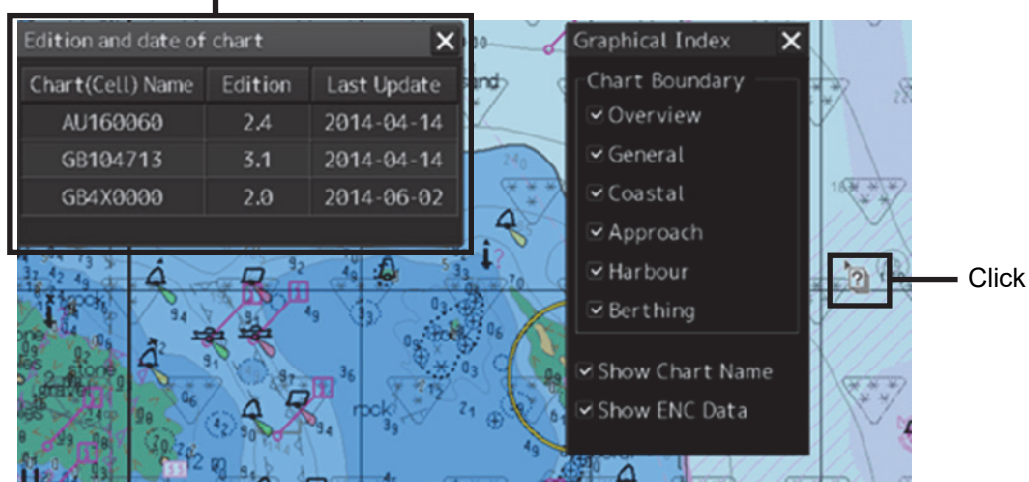

13.7 Confirming Temporary/Preliminary Information of an ARCS Chart

Temporary/preliminary information (T&P: Temporary and Preliminary Notices) of an ARCS chart can be confirmed.

- 1 Click on the [Menu] button on the left toolbar.

The menu is displayed.

- 2 Click on the [Chart] - [T & P] on the menu.

The [T & P] dialog box appears.

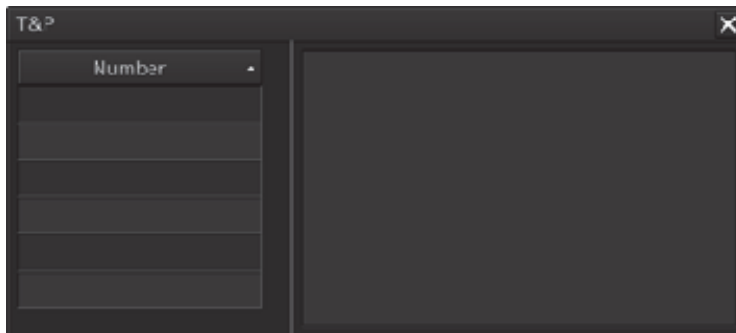

- 3 Click on the number whose contents are to be confirmed on the [Number] list.

The temporary/preliminary information of the chart of the specified number is displayed on the right side.

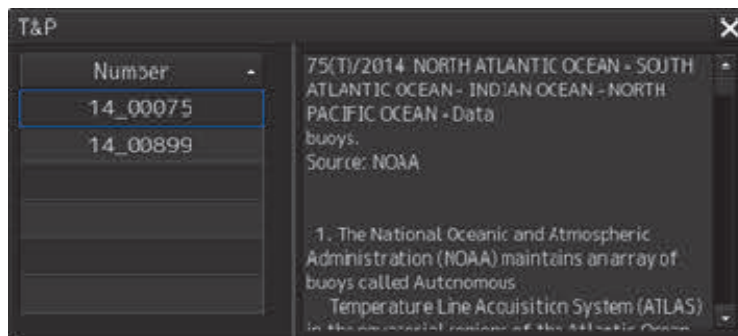

The list can be sorted by clicking on any item of the title column.

Note

Temporary/preliminary information is included in the ARCS chart itself. Since the information may not be included depending on the chart, the information may not be displayed.

13.8 Adjusting an ARCS Chart Position

Note

Adjust the offset only when the geodetic datum of the chart is a local geodetic datum and the display position is not adjusted correctly.

13.8.1 Offsetting an ARCS chart

Move the chart by entering offset values (latitude and longitude) or using the cursor.

- 1 Click on the [Menu] button on the left toolbar.

The menu is displayed.

- 2 Click on the [Chart] - [Datum Offset] (geodetic offset) on the menu.

The [Datum Offset] (geodetic offset) dialog box appears.



When the previous setting values are displayed in the [Offset] box, the values can be cleared by clicking on the [Clear Offset] button.

To set offset of a chart, use the cursor or enter offset values.

Offsetting a chart with the cursor

- 1 Click on the [Offset by Cursor] button.

The button display changes to On and the offset function is enabled.

Offset by Cursor

- 2 Set the cursor to the reference point and click the mouse button.

To clear the offset values, set the button to Off by clicking on the [Offset by Cursor] button.

3 Place the cursor on the offset position and click the mouse button.

The reference point moves to the offset position.

A check mark () is displayed on the [Offset] display (start of offset).

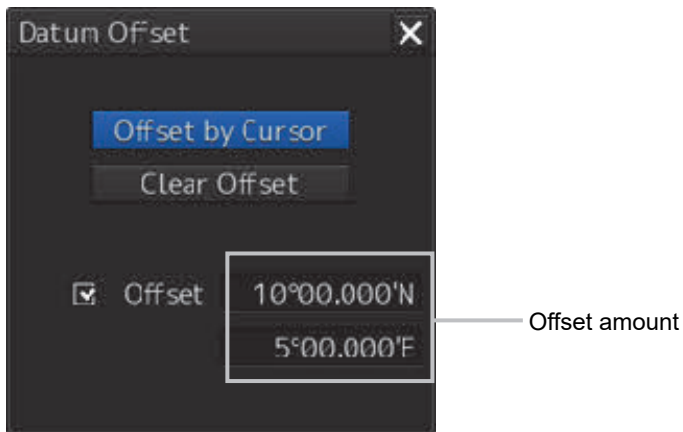

Offsetting a chart by entering an offset value

1 Enter offset values (latitude/longitude) in the [Offset] box.

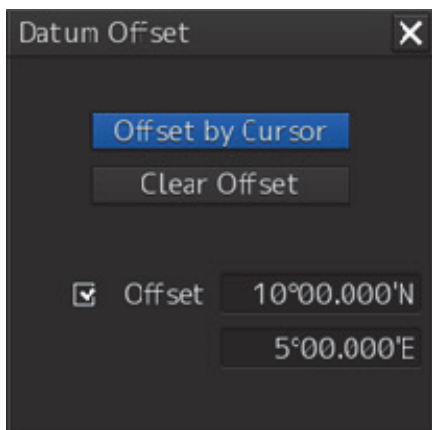

The chart is offset.

Memo
The maximum latitude input range is 85 ° 00.000 (Maximum range of latitude that can be operated during ECDIS mode).

13.8.2 Transforming a geodetic datum of an ARCS chart to WGS-84

A geodetic datum of an ARCS chart can be transformed to WGS-84 based on any position and the own ship's position.

- 1 Click on the [Menu] button on the left toolbar.

The menu is displayed.

- 2 Click on the [Chart] - [Datum Transformation] (geodetic datum transformation) on the menu.

The [Datum Transformation] (geodetic datum transformation) dialog box appears.

Datum Transformation

Geodetic Datum

From

To WGS84

Reference Position

Position 0°00.000'N
0°00.000'E

Ship Position by Cursor

Chart Shift

Reference Position

Position 0°00.000'N
0°00.000'E

Shifted Position

Position 0°00.000'N
0°00.000'E

OK Cancel

Note

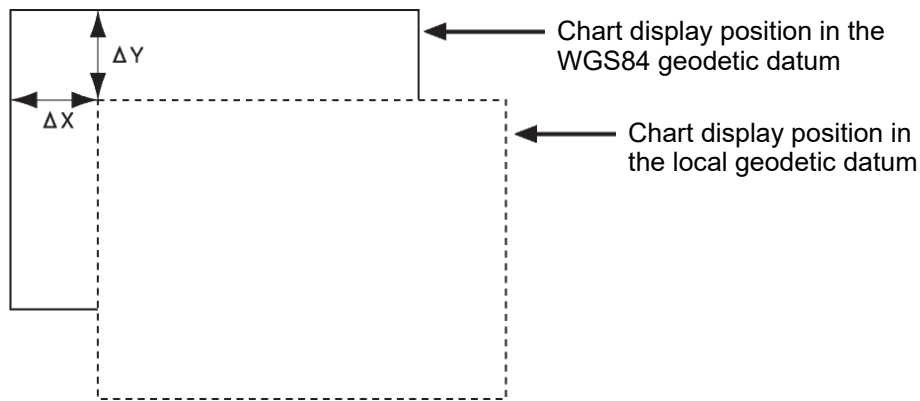

ΔX and ΔY : Offset amount to WGS84

When ΔX and ΔY are included in the chart information, the system automatically offsets the amount to WGS84 and displays the result. In this case, a check mark is attached to Offset of "Datum Offset" and "Chart Shift to WGS84" is displayed in the alert notification area.

As shown above, even if the offset amount is determined in the [Datum Transformation] dialog box for the chart that is displayed under WGS-84 and the [OK] button is clicked on, this function is disabled and the message, "The Datum is already WGS-84", is displayed.

3 Select a geodetic system from the [From] combo box of [Geodetic Datum].

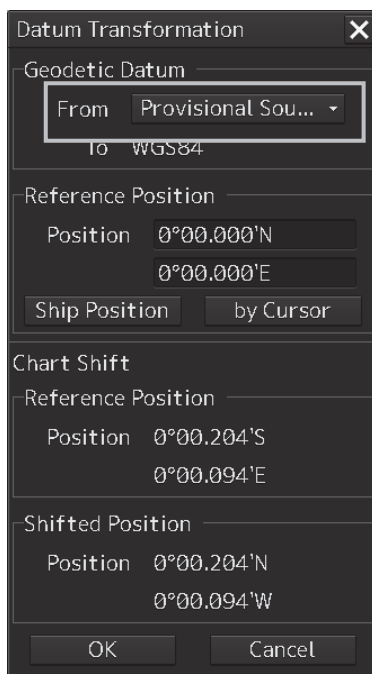

Memo

For the geodetic datum that is displayed in the [From] combo box, refer to "D.3 Geodetic datum abbreviations". However, "No Use" in No.9, No.10, No.48 and No.49 is not displayed.

4 Enter a latitude and a longitude in the [Position] input boxes of [Reference Position].

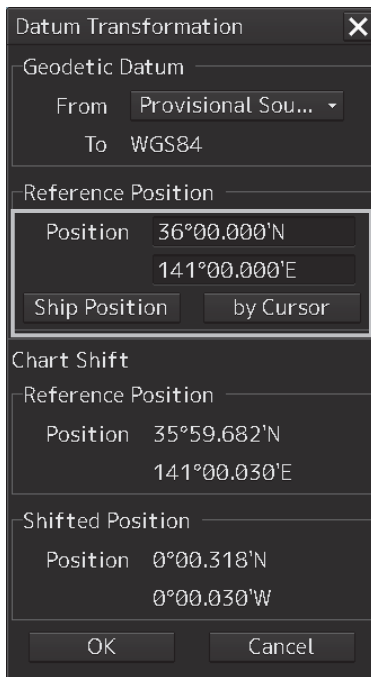

When the [Ship Position] button is clicked on, the latitude and the longitude of the own ship's position is displayed in the [Position] input boxes.

When the [by Cursor] button is clicked on, the cursor changes to the offset cursor. When the mouse button is clicked on the chart, the latitude and longitude of the point on which the mouse button was clicked is displayed in the input boxes.

Information after transformation is displayed on [Chart Shift].

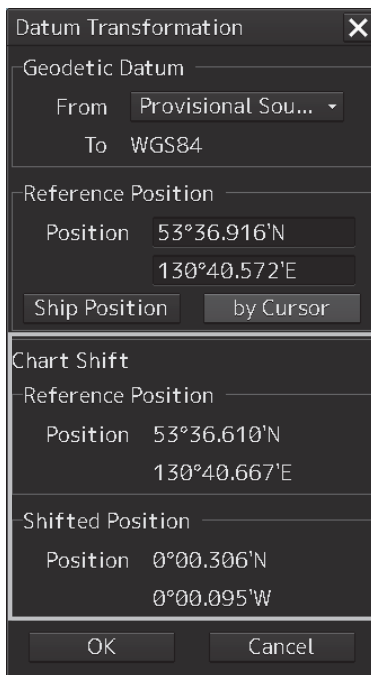

The position shifted after geodetic datum transformation is displayed in [Reference Position].
The offset amount after geodetic datum transformation is displayed in [Shifted Position].

5 Click on the [OK] button.

The transformation is determined.

13.9 Displaying a Chart Abbreviation List

A list describing chart abbreviations can be displayed.

- 1 Click on the [Menu] button on the left toolbar.**
The menu is displayed.
- 2 Click on the [Chart] - [Chart Abbreviation] on the menu.**
The [Chart Abbreviation] dialog box appears.

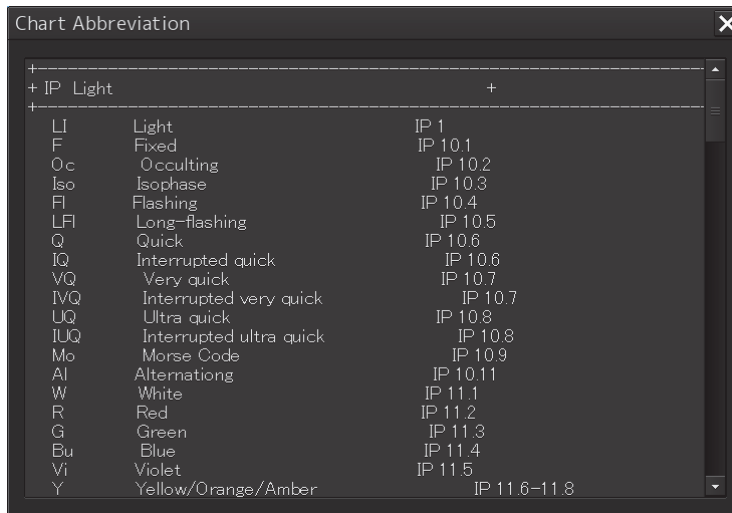

13.10 Displaying an ENC Update Status Report

This function displays a latest report of S-57 and C-MAP within the system.

This function also displays a latest report of S-57 and C-MAP relating to the specified route.

- 1 Click on the [Menu] button on the left tool bar.
- 2 Click on [Chart] – [ENC update status report] on the menu.
The [ENC update status report] dialog is displayed.

[S-57]

The first screenshot shows the Information tab with the following data:

Report	Value
Ship's Name	
MMSI	636090412
ENC Update Reference Date(UTC)	2017-04-06 WK14/2017
Date Of Report(UTC)	2017-08-09
Content	Full SENC Contents.

The second screenshot shows the Summary tab with the following chart data:

Chart Status	Count
Total	13240
Up To Date	0/13240
Not Up To Date	13236/13240
Withdrawn	4/13240
Unknown	0/13240

The third screenshot shows the Status Report tab with the following table:

Cell Name	Edition	Update	Issue
AR201130	3	5	21
AR201140	1	23	21
AR202100	2	0	21
AR202140	1	2	21
AR202150	1	1	21
AR203100	1	13	21
AR203170	1	4	21
AR204130	1	1	21

[C-MAP]

The first screenshot shows the Information tab with the following data:

Report	Value
Ship's Name	
MMSI	*****
ENC Update Reference Date(UTC)	
Date Of Report(UTC)	2017-06-26
Content	Full SENC Contents.

The second screenshot shows the Summary tab with the following chart data:

Chart Status	Count
Total	0
Up To Date	0/0
Not Up To Date	0/0
Withdrawn	0/0
Unknown	0/0

The third screenshot shows the Status Report tab with an empty table.

Set the [Route filter] check box to ON and select a route on the [Select Route] combo box.

The update report relating to the selected route (Route filtered ENC update status report) is displayed, the list items that are displayed by each tab increase, and the contents change.

In C - MAP, selecting database in the [C - MAP Database] combo box, you can display only the information of the selected database.

The details of the items that are displayed by each tab are shown below.

Contents displayed by the Information tab

No.	Item	Operation/Condition	Input range/Default value
1.	Ship's Name	[Operation] Displays the name of own ship that was entered by selecting Service->Installation->Ship's Parameter->Ship General->Ship's Name.	[Display range] Up to 20 characters (Same as for Ship General->Ship's Name)
2.	MMSI	[Operation] Displays MMSI of own ship, which is the same as that displayed by selecting TT/AIS->Own Ship AIS Data->MMSI.	[Display range] Up to 9 characters (Same as for TT/AIS->Own Ship AIS Data->MMSI) [Default value] Blank space
3.	Enc update reference date	[Operation] Displays a media time stamp in the following format. Latest date that was retrieved from the S-63SERIAL.ENC file. The display style complies with the style that was selected on the Date/Time screen. It will be blank when selecting All in the C-MAP Database combo box.	[Display range] YYYY-MM-DD MMM DD,YYYY DD MMM,YYYY
4.	Date of report	[Operation] Displays the year, month, and day when the ENC update status report screen is displayed. The display style complies with the style that was selected on the Date/Time screen.	[Display range] YYYY-MM-DD MMM DD,YYYY DD MMM,YYYY
5.	Content	[Operation] Displays the following character string. • ENC update status report: Full SENC contents • Route filtered ENC update status report: Filtered for route plan.	

No.	Item	Operation/Condition	Input range/Default value
6.	Start WPT Name	<p>[Operation]</p> <p>Displays the following character string.</p> <ul style="list-style-type: none"> • Route filtered ENC update status report: <Start WPT name> <p>*When no name is set, [WPT<WPT number>] is displayed.</p> <p>[Condition]</p> <ul style="list-style-type: none"> • ENC update status report: No item is displayed. 	
7.	End WPT Name	<p>[Operation]</p> <p>Displays the following character string.</p> <ul style="list-style-type: none"> • Route filtered ENC update status report: <End WPT name> <p>*When no name is set, [WPT<WPT number>] is displayed.</p> <p>[Condition]</p> <ul style="list-style-type: none"> • ENC update status report: No item is displayed. 	
8.	Start WPT Positon	<p>[Operation]</p> <p>Displays the following character string.</p> <ul style="list-style-type: none"> •Route filtered ENC update status report: <Latitude>, <Longitude> <p>*Latitude and longitude of the start WPT Example: 57°46.5636'S, 11°58.0000'E</p> <p>[Condition]</p> <ul style="list-style-type: none"> •ENC update status report: No item is displayed. 	
9.	End WPT Positon	<p>[Operation]</p> <p>Displays the following character string.</p> <ul style="list-style-type: none"> •Route filtered ENC update status report <Latitude>, <Longitude> <p>*Latitude and longitude of the end WPT Example: 54° 20.0147'S , 10° 09.3458'E</p> <p>[Condition]</p> <ul style="list-style-type: none"> •ENC update status report: No item is displayed. 	

Contents displayed by the Summary tab

No.	Item	Operation/Condition	Input range/Default value
1.	Total	[Operation] Displays the total number of cells.	
2.	Up To Date	[Operation] <Number of Up to date cells>/<Total number> Up to date: Latest update data that is displayed in the latest PRODUCTS.TXT. When the data exceeded four weeks old, Not Up to Date is displayed.	
3.	Not Up To Date	[Operation] <Number of Not Up to Date cells>/<Total number> Not up to date: Not the latest update data that is indicated in the latest PRODUCTS.TXT. Alternatively, the ENC Update Reference Date is the date four weeks prior to the date of the Date of Report.	
4.	Withdrawn	[Operation] <Number of Withdrawn cells>/<Total number> Withdrawn: Cells that have been withdrawn (does not exist in PRODUCTS.TXT) or have been cancelled.	
5.	Unknown	[Operation] <Number of Unknown cells>/<Total number> Unknown: PRODUCTS.TXT is PARTIAL and cell information is not available.	

Contents displayed by the Status report tab

No.	Item	Operation/Condition
1.	Data Server combo box	[Operation] Select a country code. (Example: GP, JP, or so on) The list length of the combo box is variable. [Condition] Display is disabled when there are no options. In case of C-MAP, it is always invalid display.
2.	Cell Name	[Operation] Displays the cell name.
3.	Edition	[Operation] Displays the edition of the cell. For the edition of the cell that has not been imported, the edition of the PRODUCTS.TXT is used.

No.	Item	Operation/Condition
4.	Update	<p>[Operation]</p> <p>Displays the update number.</p> <p>For the update number of the cell that has not been imported, the number of the PRODUCTS.TXT is used. (Latest Update Number)</p>
5.	Issue Date	<p>[Operation]</p> <p>Displays the cell issue date.</p> <p>For the issue date of the cell that has not been imported, the date of PRODUCTS.TXT is used. (Issue Date Latest Update)</p> <p>The display style complies with the style that was selected on the Date/Time screen.</p>
6.	Expiry Date	<p>[Operation]</p> <ul style="list-style-type: none"> • Route filtered ENC update status report: Displays the expiry date. <p>The display style complies with the style that was selected on the Date/Time screen.</p> <p>[Condition]</p> <ul style="list-style-type: none"> • ENC update status report: No item is displayed.
7.	Status	<p>[Operation]</p> <p>Displays one of the following statuses.</p> <ul style="list-style-type: none"> • Up to date • Not up to date • Withdrawn • Unknown ※S-57 only display
8.	Action	<p>[Operation]</p> <ul style="list-style-type: none"> • Route filtered ENC update status report: Displays one of the following actions. <ul style="list-style-type: none"> • Renew: The permit will expire in less than 30 days. • To be ordered: Although the cell range that is indicated in PRODUCTS.TXT intersects with the route, there is no permit. (S-57 only display) • No action: The permit is effective for 30 days or longer. • To be removed: A cell is not found from the FULL PRODUCTS.TXT or it has been cancelled. • To be installed: Although the cell range that is indicated in PRODUCTS.TXT intersects with the route and the permit is available, it has not been imported. (S-57 only display) <p>[Condition]</p> <ul style="list-style-type: none"> • ENC update status report: No item is displayed.

3 Click on the row of the chart to be displayed from the C-MAP chart list.

The chart is selected.

4 Click on the [Show] button.

The selected chart is displayed at the center of the screen and a red line is displayed at the cell boundary.

The updated object is displayed in highlight mode.

5 To reset the updated chart to the pre-update state, select two or more target charts from the list and click on the [Reject] button.

When the [Reject] button is clicked on, the automatic update of the chart is rejected and the chart is reset to the pre-update state.

6 Close the [Check Applied C-MAP Updates] dialog.

The red line at the cell boundary is cleared and the highlighted display of the updated object also terminates.

The following objects can not be rejected with C-MAP.

- Depth area
- Dredged area
- Floating dock
- Hulk
- Land area
- Pontoon
- Unsurveyed area

Note

The [Check Applied C-MAP Updates] dialog is displayed only when only one check is ON in C-MAP Ed 3 Database of [View-Option] - [Chart Common].

Otherwise, this dialog is not displayed.

When multiple checks are ON for C-MAP Ed3 Database in [View-Option] - [Chart Common], clicking [Menu] - [Chart] - [Check Applied C-MAP Updates] opens the popup shown below and [Chart Common] dialog.

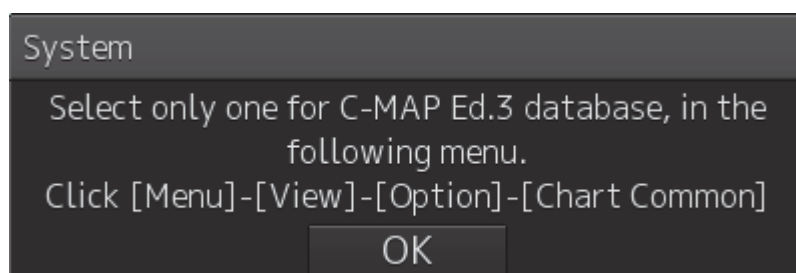

13.12 Displaying license information of C-MAP

C-MAP license information can be displayed on a popup window of the RADAR and ECDIS screens.

13.12.1 Setting license information display to ON

- 1 Click on the [Menu] button of the Left Tool Bar.**

A menu is displayed.

- 2 Click on [Chart]-[Show C-MAP License Information] (C-MAP license information display) on the menu.**

A license information display turned on and a popup window indicating C-MAP license information of C-MAP is displayed.

For the details, refer to “13.12.2 C-MAP license information”.

13.12.2 C-MAP license information

13.12.2.1 License information display timing

When license information display is set to ON, the C-MAP license status is checked at the following timing and related information is displayed on a popup window of the RADAR or ECDIS screen.

Timing	Operation
[Chart]-[Show C-MAP License Information] are selected on the menu.	<ul style="list-style-type: none"> • Always a popup window is displayed. • The static license is displayed. • The dynamic license is displayed if it has been activated.
The RADAR/ECDIS task is started.	<ul style="list-style-type: none"> • When Chart Type of [View1] or [View2] is set to C-MAP3 on the [View Options] dialog that is displayed by selecting [View]-[Options]-[Chart View] on the menu, a popup window is displayed if the condition is satisfied. • Although the static license is displayed, it is not displayed if there is ample time until the expiration of the static license. • The dynamic license is displayed if it has been activated.
The date of the UTC time is changed while the RADAR/ECDIS task is active.	<ul style="list-style-type: none"> • When Chart Type of [View1] or [View2] is set to C-MAP3 on the [View Options] dialog that is displayed by selecting [View]-[Options]-[Chart View] on the menu, a popup window is displayed if the condition is satisfied. • Although the static license is displayed, it is not displayed if there is ample time until the expiration of the static license. • The dynamic license is displayed if it has been activated.
The Chart Type setting of [View1] or [View2] is changed in the [View Options] dialog by selecting [View]-[Options]-[Chart View] in the menu	<ul style="list-style-type: none"> • When Chart Type is changed to C-MAP3 from any other types, a popup window is displayed when the condition is satisfied. • Although the static license is displayed, it is not displayed if there is ample time until the expiration of the static license. • The dynamic license is not displayed.

How to read the popup display

See below for an example of a popup window that indicates C-MAP license information and how to read the information.

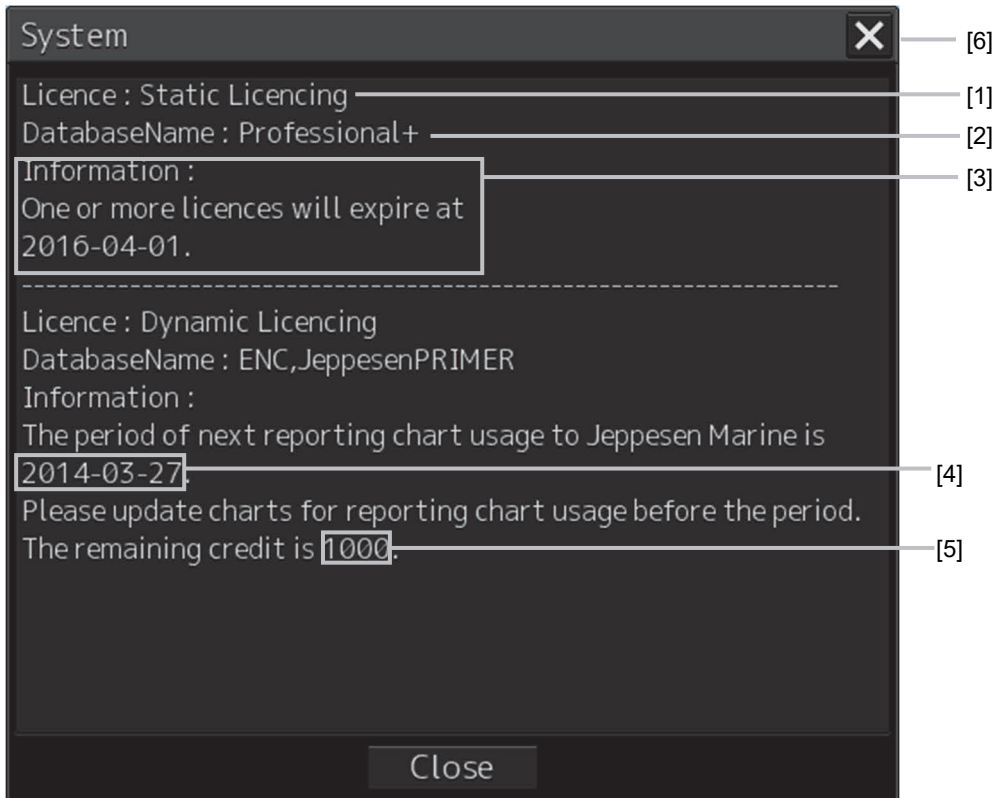

[1] License format

Static Licensing: Static license
Dynamic Licensing: Dynamic license

[2] Database name

[3] License information

Refer to "13.12.2.2 License information".

[4] Reporting expiration date

[5] Remaining number of credits

[6] [X](Close) button

Click on this button to close the popup window.

13.12.2.2 License information

The following information is displayed in a popup window of the C-MAP license information.

License status	Information that is displayed
The dynamic license has been activated.	The period of next reporting chart usage to Jeppesen Marine is [Reporting expiration date]. Please update charts for reporting chart usage before the period. The remaining credit is [Remaining number of credits].
The dynamic license usage reporting has expired.	The period of next reporting chart usage to Jeppesen Marine has expired. You cannot access to new charts and non-reported charts. Please update charts for reporting chart usage. The remaining credit is [Remaining number of credits].
There is ample time until the expiration of the static license.	One or more licences will expire at [Date].
The static license will expire within less than 2 months.	One or more licences will expire at [Date]. Please contact your Jeppesen Marine agent for a licence renewal.
The static license has expired.	One or more licences expired. Please contact your Jeppesen Marine agent for a licence renewal.
The license has not been imported.	No licence installed.

13.13 Displaying ECDIS Chart 1

ECDIS Chart 1 can be displayed on the ECDIS screen.

By displaying ECDIS Chart 1, you can check whether new symbols introduced in IHO S-52 Presentation Library version 4.0 can be displayed.

As a matter of specification, Chart 1 must be installed in all ECDIS.

13.13.1 Import ECDIS Chart 1

Import Chart data of ECDIS Chart 1 from [Chart Maintenance] of the task menu.

The storage locations of chart data of S-57 and C-MAP are as follows.

【S-57】

"D:¥MFD¥system¥ECDIS_Chart_1"

【C-MAP】

"D:¥MFD¥system¥C-MAP_Chart_1"

For the chart import procedure, refer to a separate manual, "Additional Instruction Manual for Introducing Chart".

13.13.2 Confirm display of ECDIS Chart 1

- 1 Click MENU-[Chart]-[ECDIS Chart 1] to display the [ECDIS Chart 1] dialog.

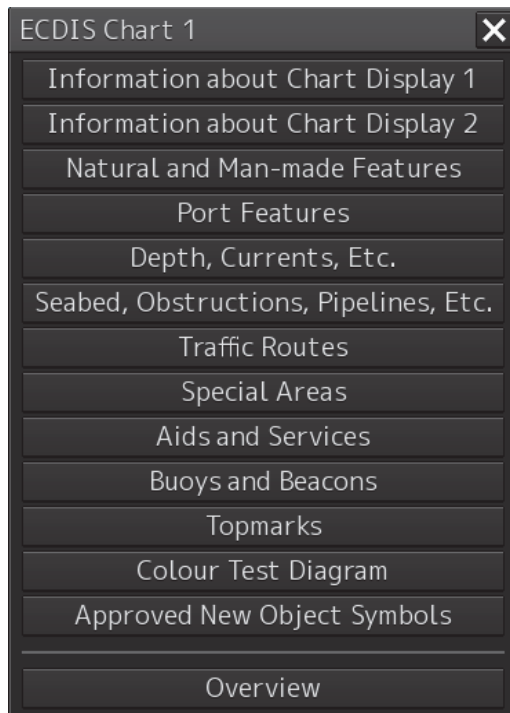

- 2 Click each button to display Chart 1.

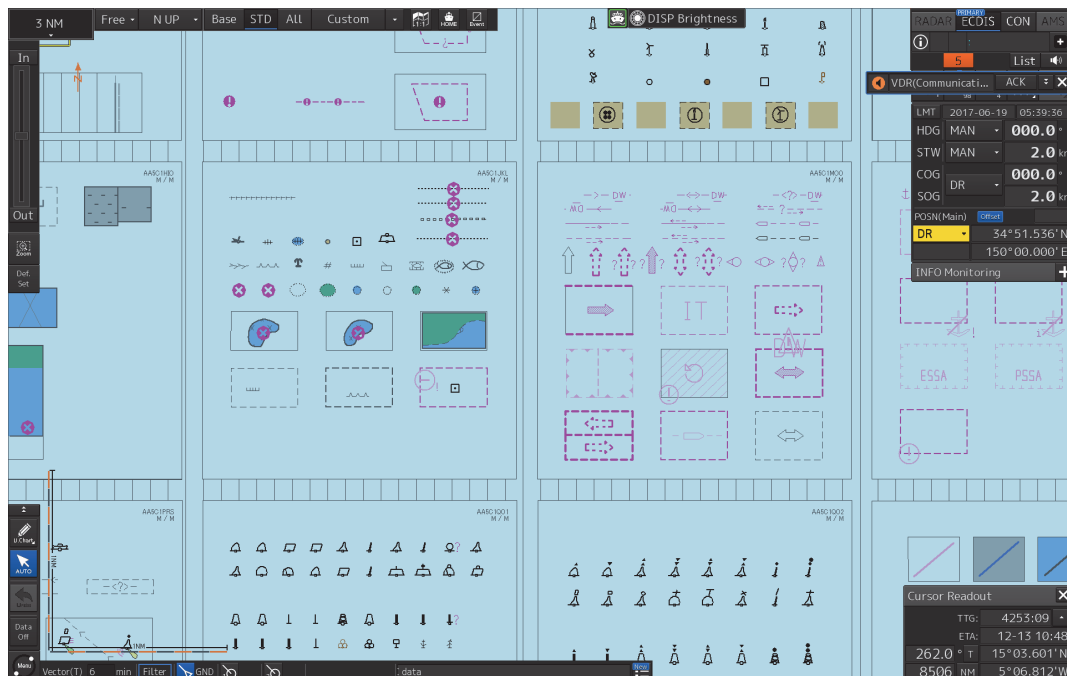

Memo

If ECDIS Chart 1 is not imported, a message prompting the import of the chart will be displayed when clicking the button.

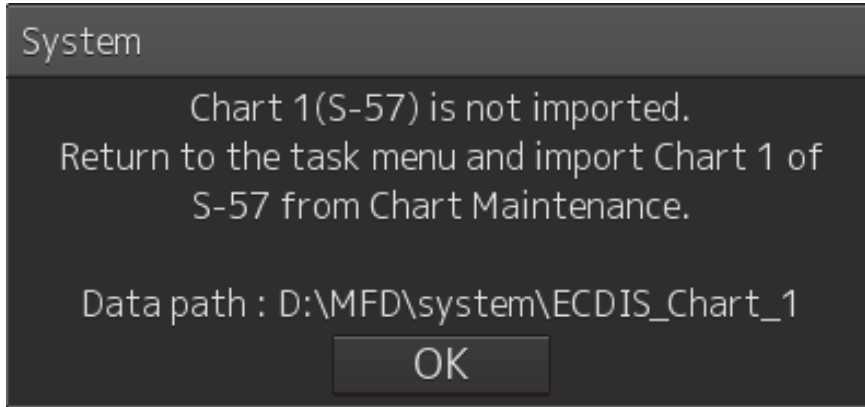
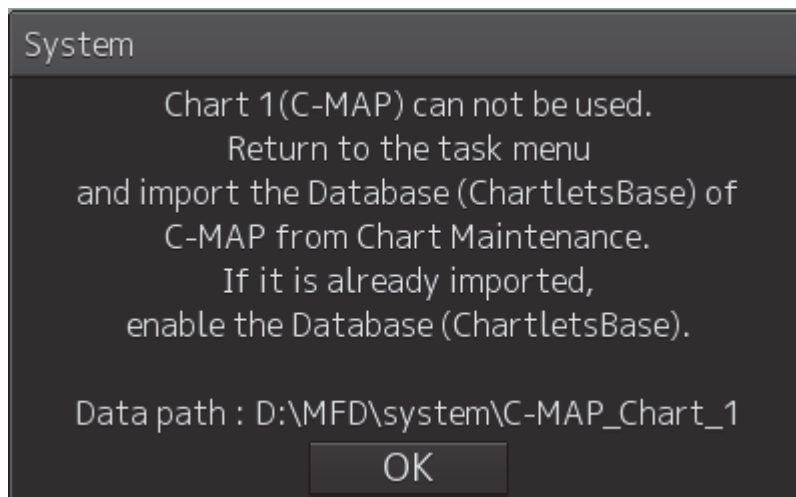
【S-57】**【C-MAP】**

13.14 Displaying differences at chart update

13.14.1 Displaying differences at S-57 chart update

When the S-57 chart is updated, only the latest object of the last Update No. is displayed in highlight mode.

Until the update is approved, the target object is displayed with a highlight marker.

When the update is approved, the highlighted display is cancelled.

The following table shows the drawing patterns of pre-approval and post-approval for each update content.

Update content	Pre-approval drawing pattern	Post-approval drawing pattern
Addition	<ul style="list-style-type: none"> When highlighted display of update is set to ON, an addition marker is displayed for the object to be added. When highlighted display of update is set to OFF, only the object to be added is drawn. 	Only the added object is drawn.
Deletion	<ul style="list-style-type: none"> When highlighted display of update is set to ON, a deletion marker is displayed for the object prior to deletion. When highlighted display of update is set to OFF, the target object is not drawn. 	Deleted objects are not drawn.
Change	<ul style="list-style-type: none"> When highlighted display of update is set to ON, a deletion marker is displayed for the pre-update object and an addition marker is displayed for the post-update object. When highlighted display of update is set to OFF, only the post-update object is drawn. 	Only the object after the change is drawn.

Addition marker

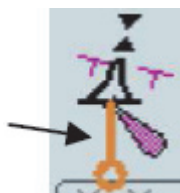

Deletion marker



13.14.2 Displaying differences at C-MAP chart update

When the C-MAP chart is updated, only the updated object of the last Update No. is displayed in highlight mode.

Since update approval operation is not available for the C-MAP chart, the update object of the last Update No. is displayed in the usual color immediately after the update.

However, when the [Check Applied C-MAP Updates] dialog is displayed, a highlighted display mark is displayed overlaying the updated object only for the cell that is selected on the screen.

The following table shows the drawing patterns at the usual state and the drawing patterns of the chart that is selected in the [Check Applied C-MAP Updates] dialog for each update content.

Update content	Drawing patterns at usual state	Drawing patterns of the chart that is selected in [Check Applied C-MAP Updates]
Addition	Only the added object is drawn.	The added object is drawn and highlighted display is overlaid on the object.
Deletion	The deleted object is not drawn.	The deleted object is not drawn and only highlighted display is drawn at the position of the object.
Change	Only the changed object is drawn.	The changed object is drawn and highlighted display is drawn over the object.

13.15 Chart pick report

For the S-57 chart, when an object is clicked on, the pick cursor is displayed on the clicked position and the [Pick Report] dialog is displayed.

Memo

The pick cursor is a square frame that is displayed at the spot where the chart information is read and the information on the chart object that exists in the frame is displayed in the [Pick Report] dialog.

When the object is a symbol or a spot depth, the object itself is not displayed in highlight mode.

For a C-MAP chart, a pick cursor is not displayed.

13.16 Maintaining a Chart

Use the Chart Maintenance menu for management of chart data.

1 Click on the [Menu] button on the left toolbar.

The menu is displayed.

In the case of ECDIS:

Change over to the second page using the page switching button.

2 Click on the [Chart Management] button on the menu.

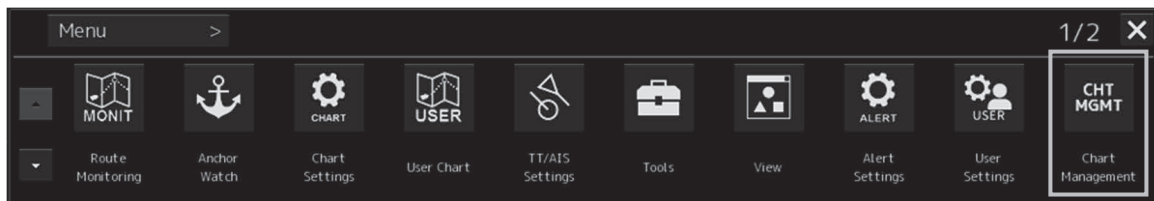

RADAR

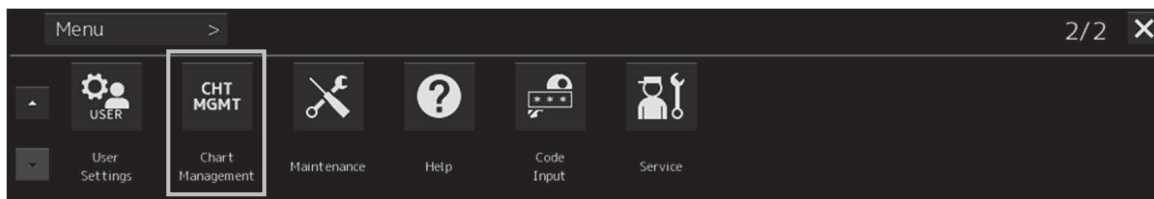

ECDIS

The [Chart Maintenance] dialog box appears.

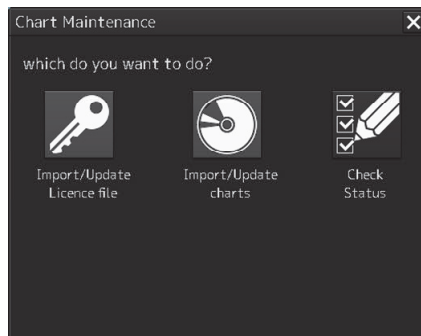

Three icons are assigned in the [Chart Maintenance] dialog box. Only the Check Status icon can be clicked.

Click on the Check Status icon when checking the status of the chart.

Note

"Import/Update Licence file" and "Import/Update charts" can also be operated by clicking from the [Chart Maintenance] dialog box started in the task menu.

Icon	Operation
Import/Update Licence file	Imports/updates the license file for importing a chart.
Import/Update charts	Imports/updates chart data.
Check Status	Checks chart status.

For the operation of the Chart Maintenance menu, refer to a separate manual, "Additional Instruction Manual for Introducing Chart".

Section 14 Creating a User Chart/ Updating a Chart Manually

This section describes the procedures for creating a user chart and updating a chart manually.

User chart

A user specific map can be created by drawing various objects (symbol, line, area, and text) that are not displayed on the existing chart. The created user chart can also be updated by editing.

A user chart can be displayed by overlapping on a chart. A user chart can be created by merging two user charts.

The following diagrams show how to use user charts.

Display example 1

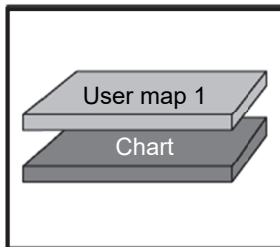

Display example 2

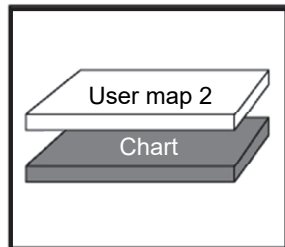

Display example 3

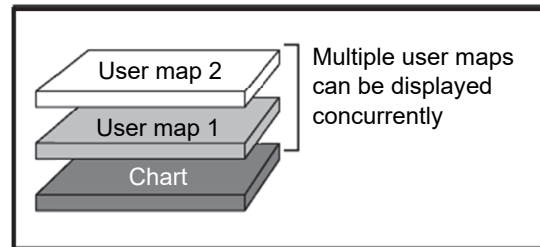

Example: User charts 1 and 2 are merged and displayed on a chart by overlaying.

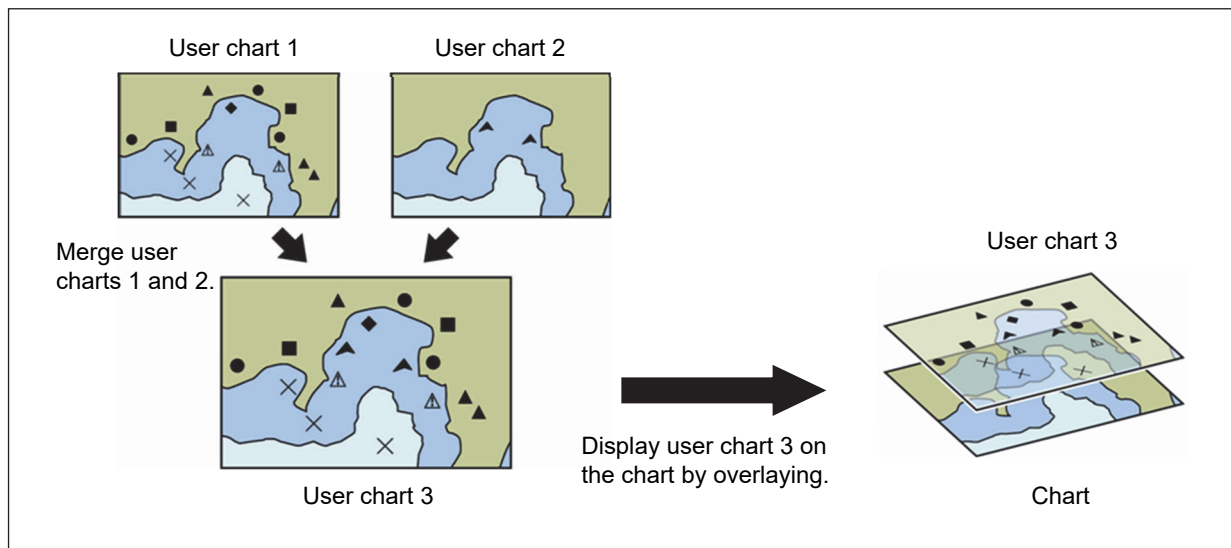

Manual Update (ECDIS screen only)

A chart can be updated manually by creating objects (symbols, lines, areas, and texts) on the specifying chart.

In the manually updated chart, objects are linked to the chart itself, unlike user charts. Therefore, although the manually updated objects can be hidden, they cannot be deleted easily.

For the details of hiding objects, refer to "14.4.1 Deleting or hiding an object" and 14.9.1 Deleting or hiding an object.

Note

Depending on the setting of Category (Base / STD / All / Custom), the added object may be hidden.

Note

When SENC SYNC is used, update chart manually at source unit that transmit the chart data.

14.1 Creating/Editing a User Chart

Use the following procedure to create/edit a user chart.

1 **Displaying the "User Chart" menu.**
Reference: "14.1.1 Display the "User Chart" menu"



2 **Displaying the "File Operation" submenu.**
Reference: "14.1.2 Display the File Operation submenu."



3 **Registering a new user chart file.**
Reference: "14.1.3 Creating a new user chart".

3 **Invoking an existing user chart file.**
Reference: "14.1.4 Editing the existing user chart".



4 **Creating/editing a user map by using map creation tools.**
Reference: "14.2 Using Map Creation Tools (User Chart Creation/Editing)".

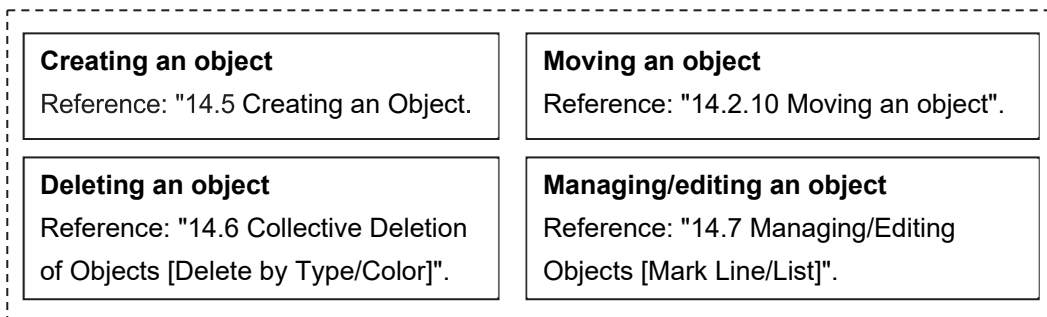

14.1.1 Display the "User Chart" menu

When creating/editing a user chart, use the "User Chart" menu.

1 Click on the [Menu] button on the left toolbar.

The menu is displayed.

2 Click on the [User Chart] button on the menu.

The submenu is displayed.

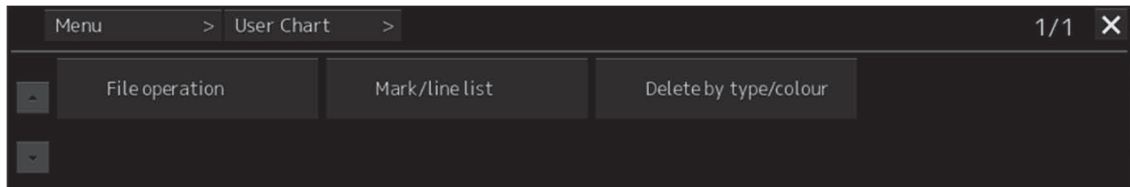

The User Chart menu comprises the following submenus.

Submenu	Function
File operation	<ul style="list-style-type: none">• Managing user chart files (new creation, loading, copying, deletion, import/export, geodetic conversion)• Displaying/editing a user chart• Merging user chart files Refer to "14.1.6 Operating a user chart file".
Delete by type/colour	Deleting objects collectively Refer to "14.6 Collective Deletion of Objects [Delete by Type/Color]".
Mark/line list	Managing/editing objects Refer to "14.7 Managing/Editing Objects [Mark Line/List]".

14.1.2 Display the File Operation submenu

- 1 Click on the [Menu] button on the left toolbar.
The menu is displayed.
- 2 Click on the [User Chart] button on the menu.
- 3 Click on the [File Operation] button on the submenu.
The [File Operation] dialog box appears.

14.1.2.1 [File Operation] dialog box

Manage the file at user chart creation and display and edit the user chart on the [File Operation] dialog box.

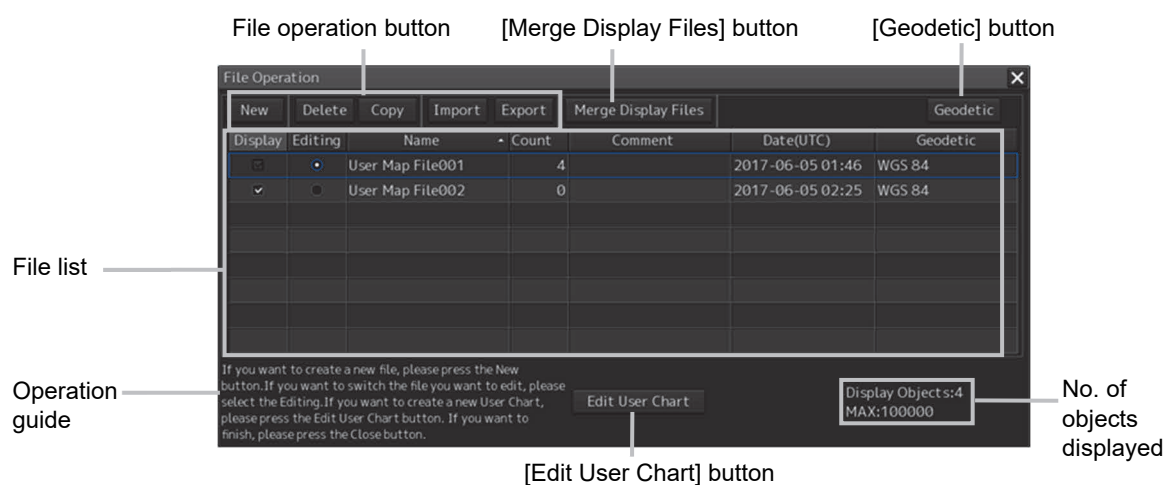

The user chart files that are currently saved are displayed in the file list.

The number of objects that are displayed is indicated at the bottom right corner of the dialog.

File list

Up to 500 user chart files (.uchm) can be registered in a file list. The following information is displayed for the user chart files that are currently saved.

Item	Information
[Name]	Indicates the name of the user chart file (up to 64 characters). The name can be changed by clicking on the name in the list.
[Count]	Indicates the total number of objects that are registered in the user chart file.
[Comment]	Indicates the comment on the user chart file (up to 64 characters). The comment can be changed by clicking on the comment in the list.
[Date]	Last update date of the user chart file
[Geodetic]	Displays the geodetic datum of the user chart file. To change the geodetic datum, refer to "14.1.6.6 Performing geodetic datum conversion".
[Display]	The [Display] check box is checked for the user chart file that is displayed. For the method of using the [Display] check box, refer to "14.1.5 Displaying a user chart".
[Editing]	The [Editing] button is set to ON for the user chart file that is being created or edited. For the method of using the [Editing] button, refer to "14.1.4 Editing the existing user chart".

File operation buttons

Button name	Function
[New]	Creates a new user chart file. For the details, refer to "14.1.3 Creating a new user chart".
[Delete]	Deletes a user chart file. For the details, refer to "14.1.6.1 Deleting a user chart file".
[Copy]	Copies a user chart file For the details, refer to "14.1.6.2 Copying a user chart file".
[Import]	Imports a user chart file from an external medium. For the details, refer to "14.1.6.3 Importing a user chart file".
[Export]	Exports the user chart that was created to an external medium. For the details, refer to "14.1.6.4 Exporting a user chart file".

[Merge Display Files] button

This button merges the selected user chart files.

For the details, refer to "14.1.6.5 Merging multiple user chart files".

[Geodetic] button

This button selects the geodetic datum of the user chart file.

For the details, refer to "14.1.6.6 Performing geodetic datum conversion".

[Edit User Chart] button

This button edits the existing user chart file.

For the details, refer to "14.1.4 Editing the existing user chart".

14.1.3 Creating a new user chart

- 1 Click on the [Menu] button on the left toolbar.**
The menu is displayed.
- 2 Click on the [User Chart] button on the menu.**
- 3 Click on the [File Operation] button on the submenu.**
The [File Operation] operation dialog box appears.

[New] button

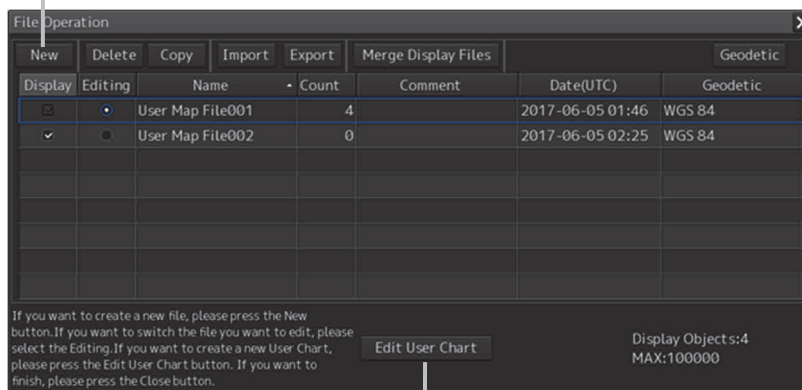

[Edit User Chart] button

- 4 Click on the [New] button.**
The new user chart file is registered in the file list.
The file name can be changed by clicking on the file name that is displayed in the [Name] column in the file list.
- 5 Click on the [Edit User Chart] button in the [File Operation] dialog box.**
The map creation tool is displayed.
Create or edit the user chart by using the map creation tool. (Refer to "14.2 Using Map Creation Tools (User Chart Creation/Editing)").

14.1.4 Editing the existing user chart

- 1 Click on the [Menu] button on the left toolbar.
The menu is displayed.
- 2 Click on the [User Chart] button on the menu.
- 3 Click on the [File Operation] button on the submenu.
The [File Operation] operation dialog box appears.

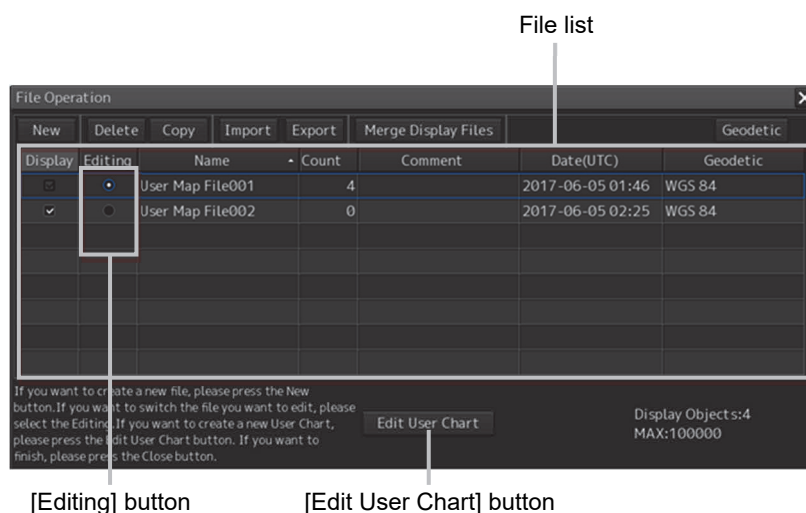

- 4 Click on the [Editing] button of the user chart file to be edited in the file list on the [File Operation] dialog.
The user chart file to be edited is displayed.
- 5 Click on the [Edit User Chart] button on the [File Operation] dialog box.
The map creation tools (drawing toolbar and the user chart information bar) are displayed and the cursor changes from the cross-hair cursor to the mark cursor.
Edit the user chart by using the map creation tools. (Refer to "14.2 Using Map Creation Tools (User Chart Creation/Editing)").

14.1.4.1 Editing the user chart that is currently displayed

- 1 Display a user chart. (Refer to "14.1.5 Displaying a user chart").
- 2 Click on the Write tool button on the left toolbar.
The map creation tools (drawing toolbar and the user chart information bar) are displayed and the cursor changes from the cross-hair cursor to the mark cursor.
- 3 Edit the user chart by using the map creation tools. (Refer to "14.2 Using Map Creation Tools (User Chart Creation/Editing)").

- 4 To edit another user chart, click on the [File Operation] dialog display button on the user chart information bar. (Refer to "14.2 Using Map Creation Tools (User Chart Creation/Editing)").

The [File Operation] dialog box appears.

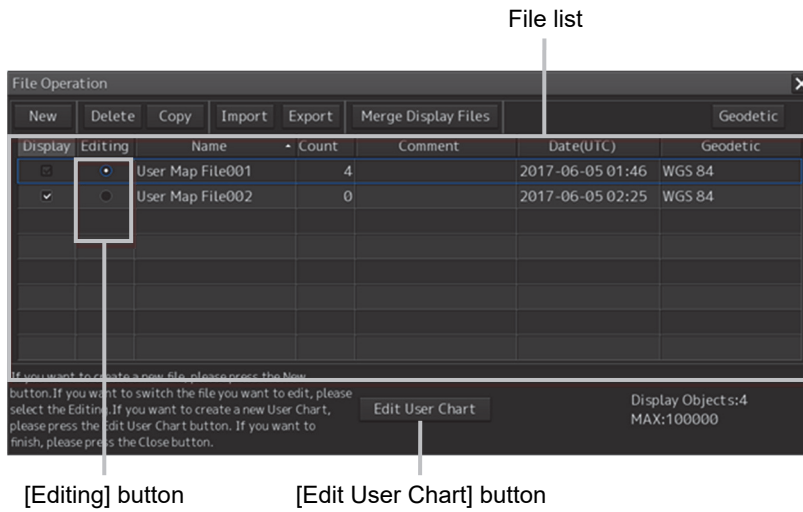

- 5 Click on the [Editing] button of the user chart file to be edited in the file list on the [File Operation] dialog box.

The selected user chart is displayed.

14.1.5 Displaying a user chart

- 1 Click on the [Menu] button on the left toolbar.
The menu is displayed.
- 2 Click on the [User Chart] button on the menu.
- 3 Click on the [File Operation] button on the submenu.
The [File Operation] dialog box appears.

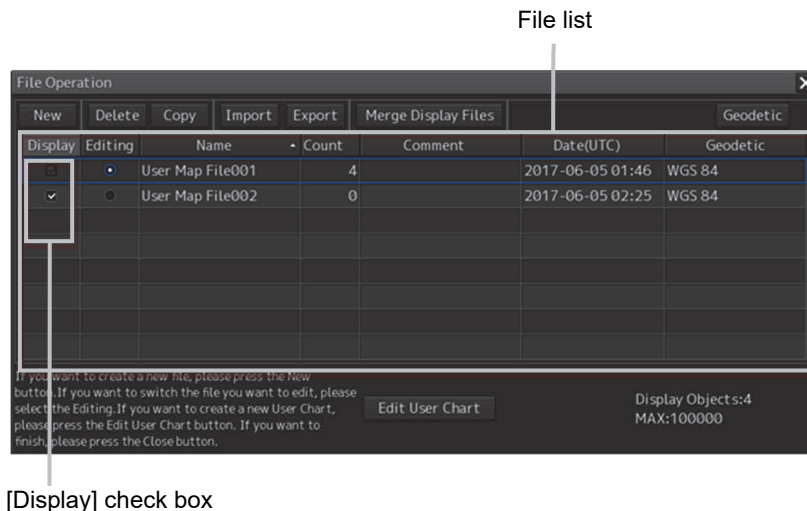

-
-
- 4 Select the [Display] check box of the user chart file to be displayed in the file list on the [File Operation] dialog box.**

The selected user chart is displayed.

14.1.6 Operating a user chart file

Manage the file at user chart creation, merge user charts, or select a geodetic datum on the [File Operation] dialog box.

14.1.6.1 Deleting a user chart file

- 1 Click on the user chart file to be deleted in the file list.**

The user chart file is selected.

- 2 Click on the [Delete] button.**

The selected user chart file is deleted.

14.1.6.2 Copying a user chart file

- 1 Click on the file to be copied in the file list.**

The user chart file is selected.

- 2 Click on the [Copy] button.**

The selected user chart file is copied.

The copied file is named under "Copy of (copy source file name)".

Note

If the file name exceeds 64 characters including "Copy of", the file cannot be copied.

14.1.6.3 Importing a user chart file

- 1 Click on the [Import] button.
A file selection window is displayed.
- 2 Select and import a user chart file that is saved in the external medium on the file selection window.

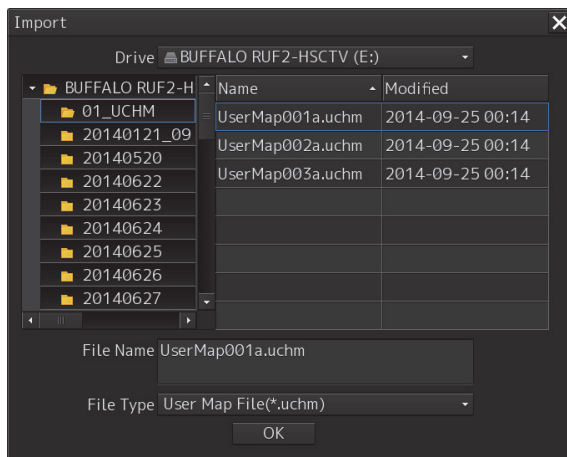

Note

When sufficient free storage space is not available in the import destination, a message dialog box is displayed.

Change the import destination or import a file after securing sufficient free space.

14.1.6.4 Exporting a user chart file

- 1 Click on the file to be exported from the file list.
A file selection window is displayed.
- 2 Click on the [Export] button.
A file selection window is displayed.
- 3 Specify an export destination and export the selected file.

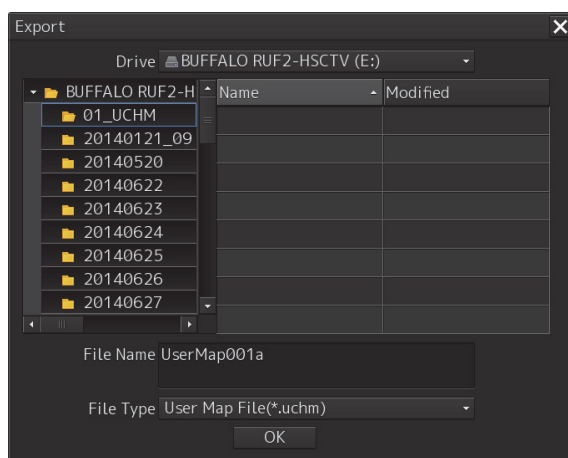

When the export destination contains a file of the same name, a message dialog box is displayed, prompting the verification of whether the existing file is to be overwritten.

When exporting the file by overwriting the existing one, click on the [OK] button.

Note

When sufficient free storage space is not available in the export destination, a message dialog box is displayed.

Change the export destination or import a file after securing sufficient free space.

14.1.6.5 Merging multiple user chart files

- 1 Select the [Display] check boxes of the files to be merged in the file list.**

The user chart files to be merged are displayed.

- 2 Click on the [Merge Display Files] button.**

A user chart file is created by merging the user charts that are being displayed. The user chart file is named under "Merged User Chart Filexxx" (xxx: serial number starting from 001).

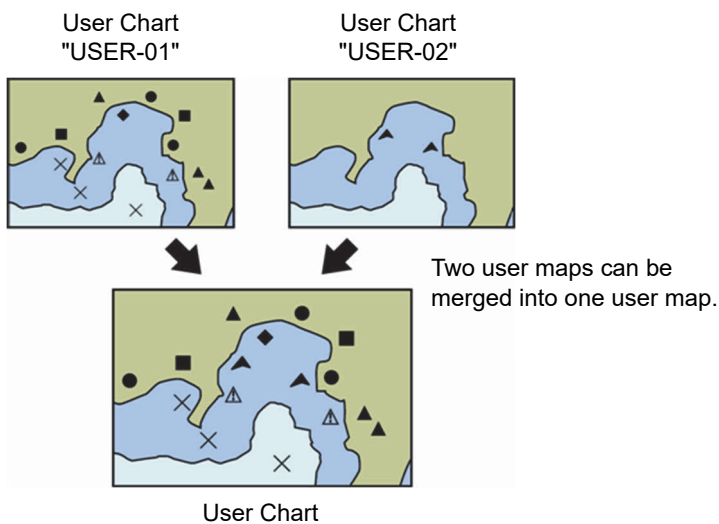

14.1.6.6 Performing geodetic datum conversion

It is possible to use the preset datum or convert the datum by entering an offset value.

- 1 Click on the user chart file whose geodetic datum is to be converted on the file list.**
The user chart file is selected.
- 2 Click on the [Geodetic] button.**
The [Geodetic Conversion] dialog appears.

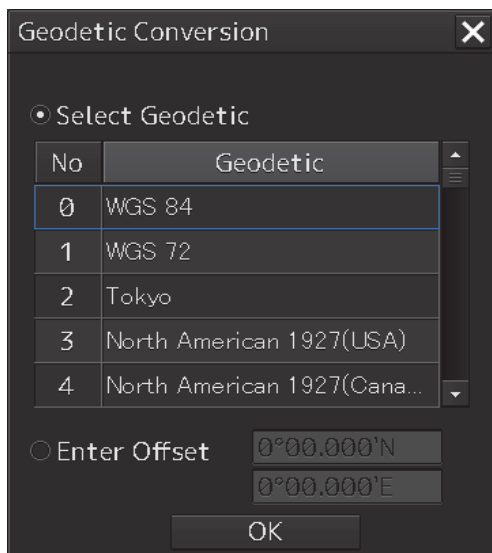

- 3 To use the preset geodetic datum, click on the [Select Geodetic] button and click on the geodetic datum on the list.**
When entering an offset value, click on the [Enter Offset] button and enter a numeric value.

Note

When [No Use] is selected on the [Select Geodetic] list, geodetic datum conversion is not performed.

- 4 Click on the [OK] button.**
Geodetic datum conversion is executed based on the setting in Step 3.

14.2 Using Map Creation Tools (User Chart Creation/Editing)

Use the map creation tools to create/edit a user chart or update a chart manually. The following tools can be used for user chart creation.

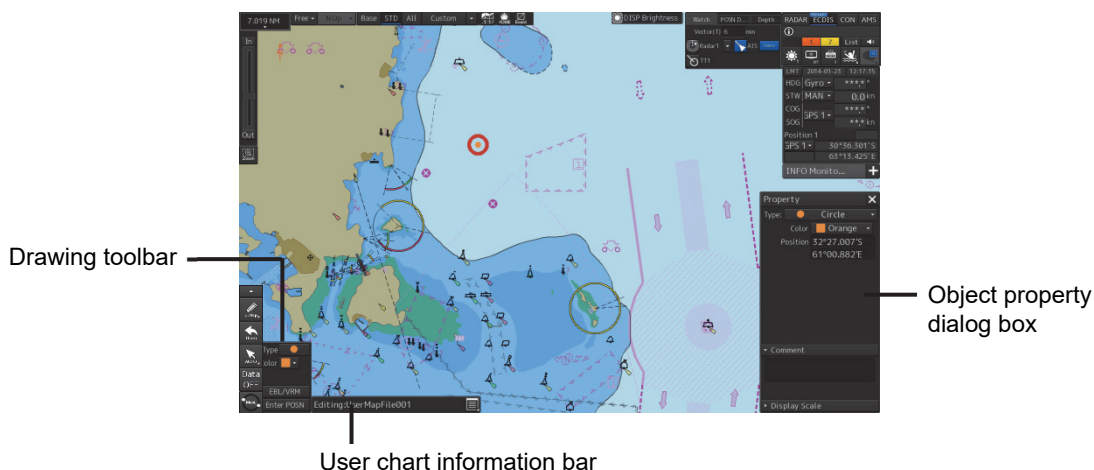

Note

The map creation tool configuration and functions vary depending on whether a chart is edited manually or a user chart is created.

For the details, refer to "14.4 How to Use the Map Creation Tools".

14.2.1 User chart information bar

The user chart information bar is located at the bottom right corner of the screen and displays the user chart name that is currently being created/edited.

The [File Operation] dialog box can be displayed by clicking on the [File Operation] dialog box display button.



14.2.1.1 Displaying a user chart information bar

- 1 Select [User Chart] - [File Operation] on the menu.
- 2 Click on the [Edit User Chart] button on the [File Operation] dialog box that is displayed.

The user chart information bar can also be displayed by clicking on the write tool button on the left toolbar.

14.2.2 Drawing toolbar

Display a drawing toolbar by clicking on the drawing tool button on the left toolbar.

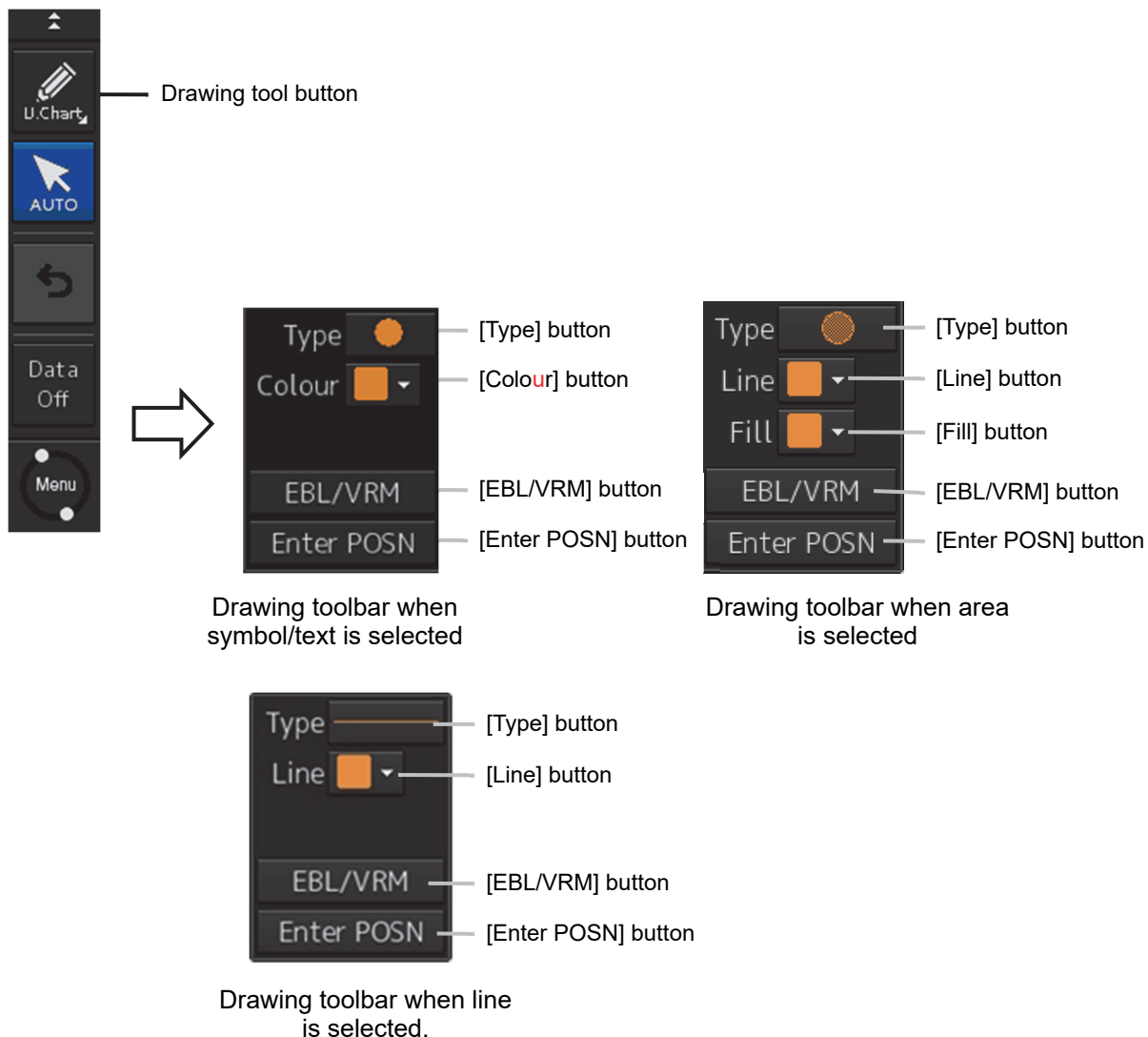

When creating a user chart, the writing tool button is displayed in blue indicating selection.

Note

At user chart creation, the azimuth mode is fixed to the [N UP] mode.

The drawing toolbar comprises the following tool buttons. The buttons that are assigned vary according to the object type (Symbol/Line/Area/Text) that is currently selected.

Tool button	Function
[Type] button	Displays an icon list. (Refer to "14.2.3 Selecting an object type".).
[Colour] button (Symbol/text selection)	Select the colour of the symbol/text. (Refer to "14.2.4 Selecting a color of an object".).
[Line] button	Enables selection of a colour of the line that forms the object. (Refer to "14.2.4 Selecting a color of an object".).
[Fill] button (at area selection only)	Enables selection of a colour of the area that forms the object. (Refer to "14.2.4 Selecting a color of an object".).
[EBL/VRM] button	Switches the cursor mode of the user chart creation function to the EBL/VRM mode. (Refer to "14.2.5 Creating an object in the EBL/VRM mode".).
[Enter POSN] ([Enter Position] dialog display) button	Displays the [Enter Position] dialog (Refer to "14.2.6 Creating an object by specifying latitude and longitude".).

14.2.3 Selecting an object type

By displaying an icon list, the type of the Mariner's Mark/Line object or the user chart object ([Symbol], [Line], [Area], and [Text]) can be selected.

1 Click on the [Type] button on the drawing toolbar.

An icon list is displayed.

2 Select a type of the object by clicking on the icon in the icon list.

The icon list can be switched to thumbnail display or list display by clicking on the thumbnail/list display switching button.

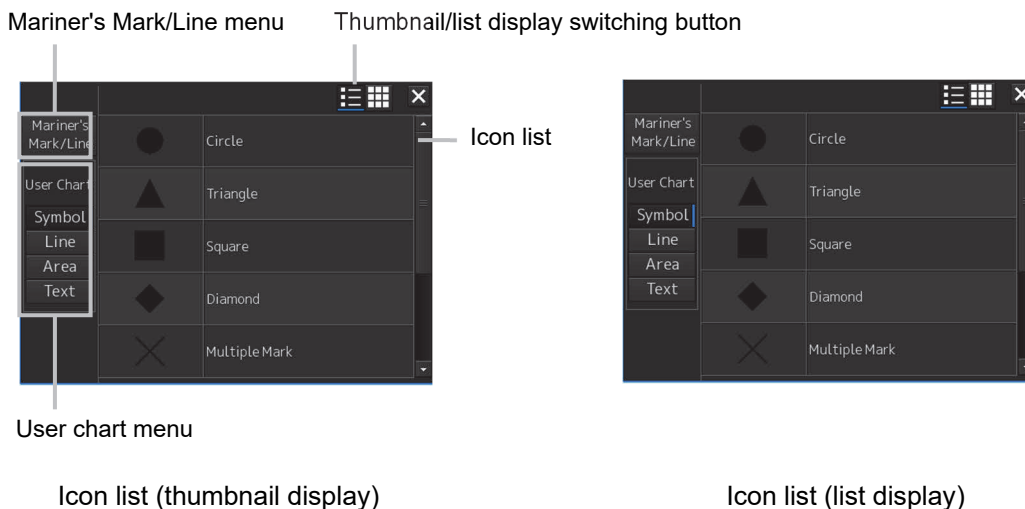

For the icons that can be selected from the icon list, refer to "Appendix D.5 Icon Button List for User Chart".

14.2.3.1 Using a user chart object

Select a type of the object (symbol/line/area/text) to be displayed in the icon list by clicking on a user chart menu button.

The following objects are displayed.

Button	Icons displayed
[Symbol] button	Circle Triangle Square Diamond Multiple Mark Caution Symbol Warning symbol Alarm Symbol
[Line] button	Simple line(solid line) Simple line(dotted line) Simple line(dashed line) Circle(solid line) Circle(dotted line) Circle(dashed line) Ellipse(solid line) Ellipse(dotted line) Ellipse(dashed line) Arc(solid line) Arc(dotted line) Arc(dashed line) Caution Line Warning line Alarm Line Arrow(Start To End/Small) Arrow(Start To End/Medium) Arrow(Start To End/Large) Arrow(End To Start/Small) Arrow(End To Start/Medium) Arrow(End To Start/Large) Arrow(Both Direct/Small) Arrow(Both Direct/Medium) Arrow(Both Direct/Large)

Button	Icons displayed
[Area] button	Polygon(solid line) Polygon(dotted line) Polygon(dashed line) Circle(solid line) Circle(dotted line) Circle(dashed line) Ellipse(solid line) Ellipse(dotted line) Ellipse(dashed line) Fan(solid line) Fan(dotted line) Fan(dashed line) Caution Detection(solid line) Caution Detection(dotted line) Caution Detection(dashed line) Warning Detection (solid line) Warning Detection (dotted line) Warning Detection (dashed line) Alarm Detection(solid line) Alarm Detection(dotted line) Alarm Detection(dashed line)
[Text] button	Text

14.2.4 Selecting a color of an object

1 When selecting a color of the symbol/text object on the drawing toolbar, click on the [Color] button.

To select a line color of an area object, click on the [Line] button.

To select a color for filling an area object, click on the [Fill] button.

2 Select and click on the required color on the list that is displayed. The following 10 colors are available.

- White/Black

(The color changes to White/Black under the following conditions.

RADAR screen: Always White

ECDIS screen: Day1/Day2: Black, Day3/Dusk/Night: White)

- Gray
- Amber
- Magenta
- Blue
- Cyan
- Green
- Yellow
- Orange
- Dark Red

14.2.5 Creating an object in the EBL/VRM mode

- 1 Click on the [EBL/VRM] button on the drawing toolbar.

The user chart creation function mode is switched from the cursor mode to the EBL/VRM mode.

When the mode is switched to the EBL/VRM mode, the cursor changes to the following state.

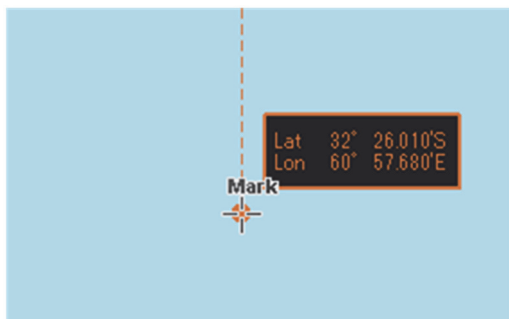

EBL/VRM base point cursor

The EBL/VRM mode is switched to cursor mode when the right mouse button is clicked on the chart or the [Enter POSN] button on the drawing toolbar is clicked on

14.2.6 Creating an object by specifying latitude and longitude

Using the [Enter Position] dialog box, it is possible to create an object at the specified latitude and longitude.

Displaying the [Enter Position] dialog box

- 1 Click on the [Enter POSN] button on the drawing toolbar.

Note

An object cannot be created with the cursor mode and EBL/VRM mode while this dialog box is displayed.

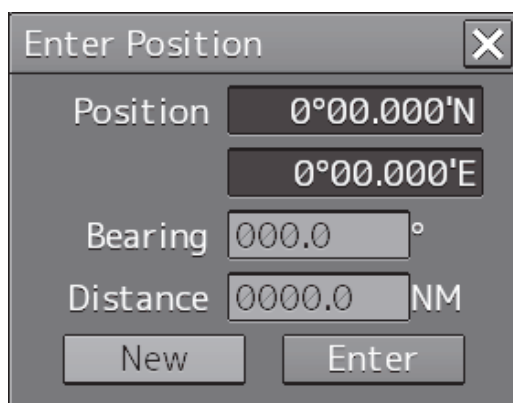

[Enter Position] dialog box

14.2.6.1 Creating an object of symbol/circle/ellipse/arc/arrow/text

Enter latitude and longitude values of the object in the [Position] box and click on the [Enter] button.

Memo

The maximum latitude input range of Position is 85 ° 00.000 (polar range restriction).

The [Bearing] box, [Distance] box, and the [New] button are disabled.

14.2.6.2 Creating an object of simple line/polygon/highlight

Use the following procedure to create an object with vertices such as a simple line, polygon, and highlight.

- 1 Enter latitude and longitude values of a vertex of the object in the [Position] box and click on the [Enter] button.**

The position of one of the vertices of the object is determined.

The [Bearing] box and the [Distance] box are enabled.

- 2 Enter latitude and longitude values of the next vertex in the [Position] box. Alternatively, in the [Bearing] box and the [Distance] box, enter the bearing and distance from the previous vertex that was determined.**

- 3 Click on the [Enter] button.**

- 4 Repeat Steps 2 and 3.**

A simple line can be determined by two or more vertices and a polygon/highlight can be determined by three or more vertices.

- 5 To create a next object continuously, click on the [New] button.**

14.2.7 Deleting an object

- 1 Click on the eraser tool button on the left toolbar.**

The cursor changes to the eraser cursor.



- 2 Place the cursor on the eraser cursor and click the mouse button.**

When the right button is clicked on any position with the eraser cursor, the cursor mode is reset to the cross-hairs cursor.

Objects of the same shape or color can be deleted collectively. For the details, refer to "14.6 Collective Deletion of Objects [Delete by Type/Color]".

When the left mouse button is clicked on the target object in eraser mode, an operation according to the object is performed.

14.2.8 Object property dialog box

An object property dialog box displays the properties of the object that is currently selected. Parameter settings of the object can be verified/changed.

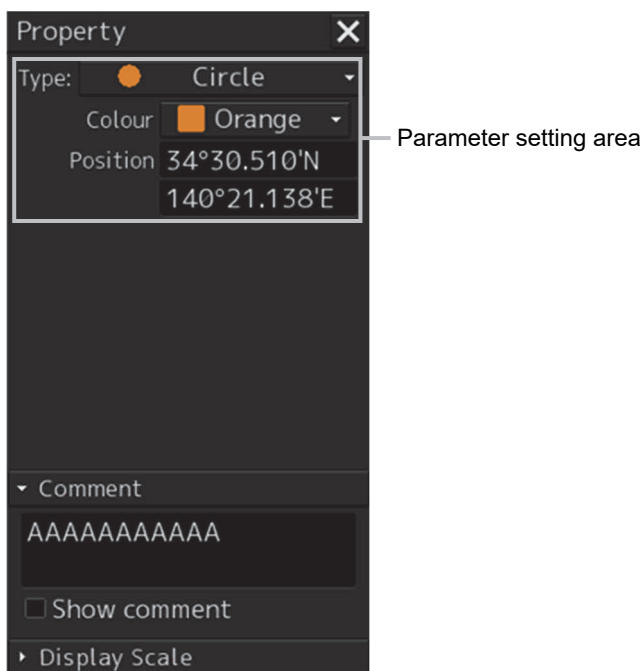

Object property dialog box
(Selecting Circle)

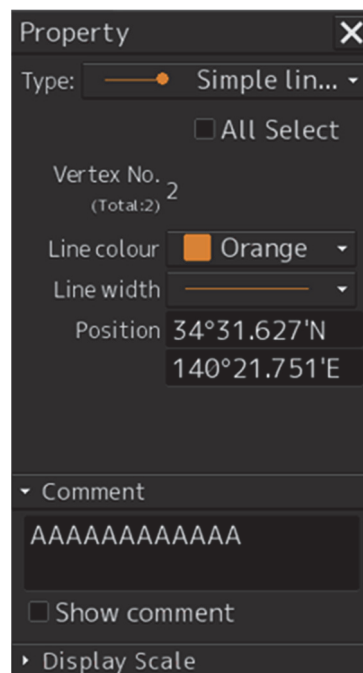

Object property dialog box
(Selecting Simple Line)

14.2.8.1 Selecting an object

- 1 Click on the object to be selected with the cross-hairs cursor.
The object is selected and the object property dialog box appears.



14.2.8.2 Setting a comment

In the object property dialog box, a comment for the object can be entered. When the [Show Comment] check box is selected, a comment can be displayed on the user chart.

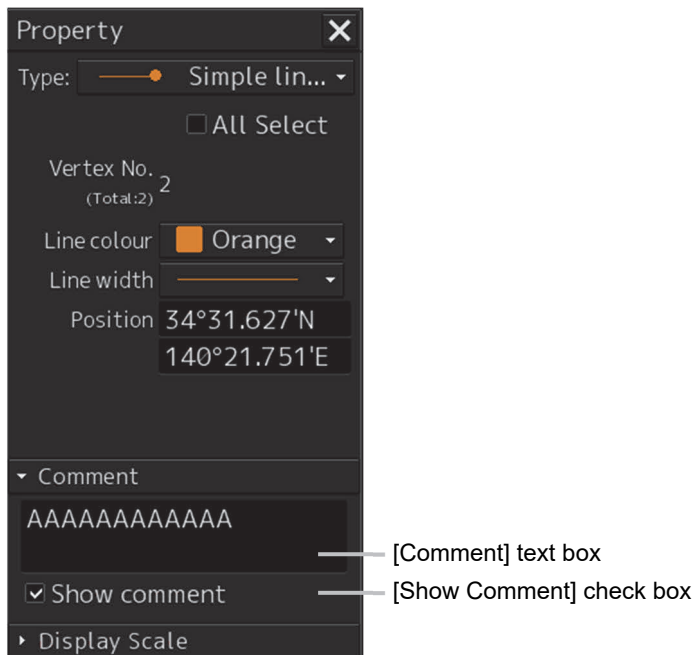

- 1** Enter a comment in the [Comment] box (up to 64 characters).
- 2** To display the comment that is input on the user chart, select the [Show Comment] check box.

14.2.9 Changing an object display scale range

An object display scale range (1:1 to 1:100,000,000) can be changed on the object property dialog box.

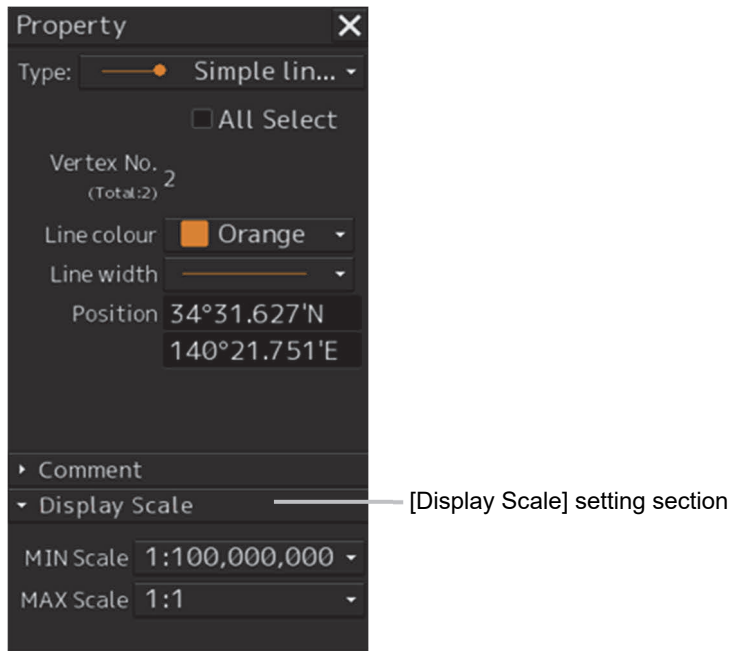

- 1 Select a minimum scale on the [MIN scale] combo box.
- 2 Select a maximum scale on the [MAX scale] combo box.

14

14.2.10 Moving an object

To move an object, use the context menu that is displayed by clicking the right button on the object.

- 1 **When the object to be moved is in the selected state, unselect the object.**
To unselect the object, click on a section without display or another object.



- 2 **Click the right button on the object.**
The object is selected and the context menu is displayed.

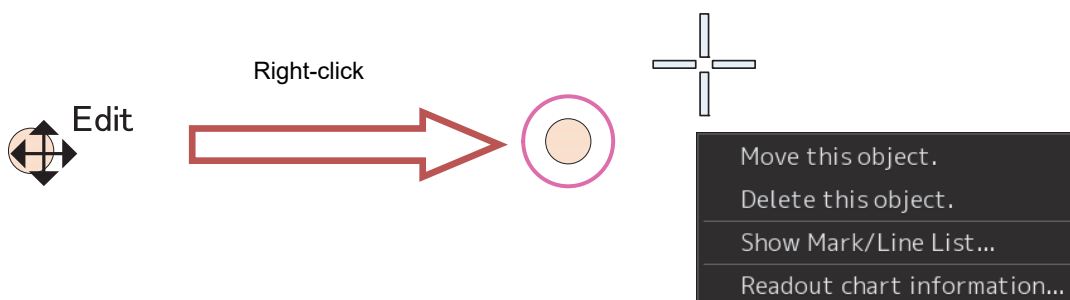

3 Click on [Move this object].

4 Click on the position to which the object is to be moved.

The selected object moves to the position on which the button was clicked.

14.3 Updating a Chart Manually (ARCS) (ECDIS Screen Only)

Use the following procedure to update a chart.

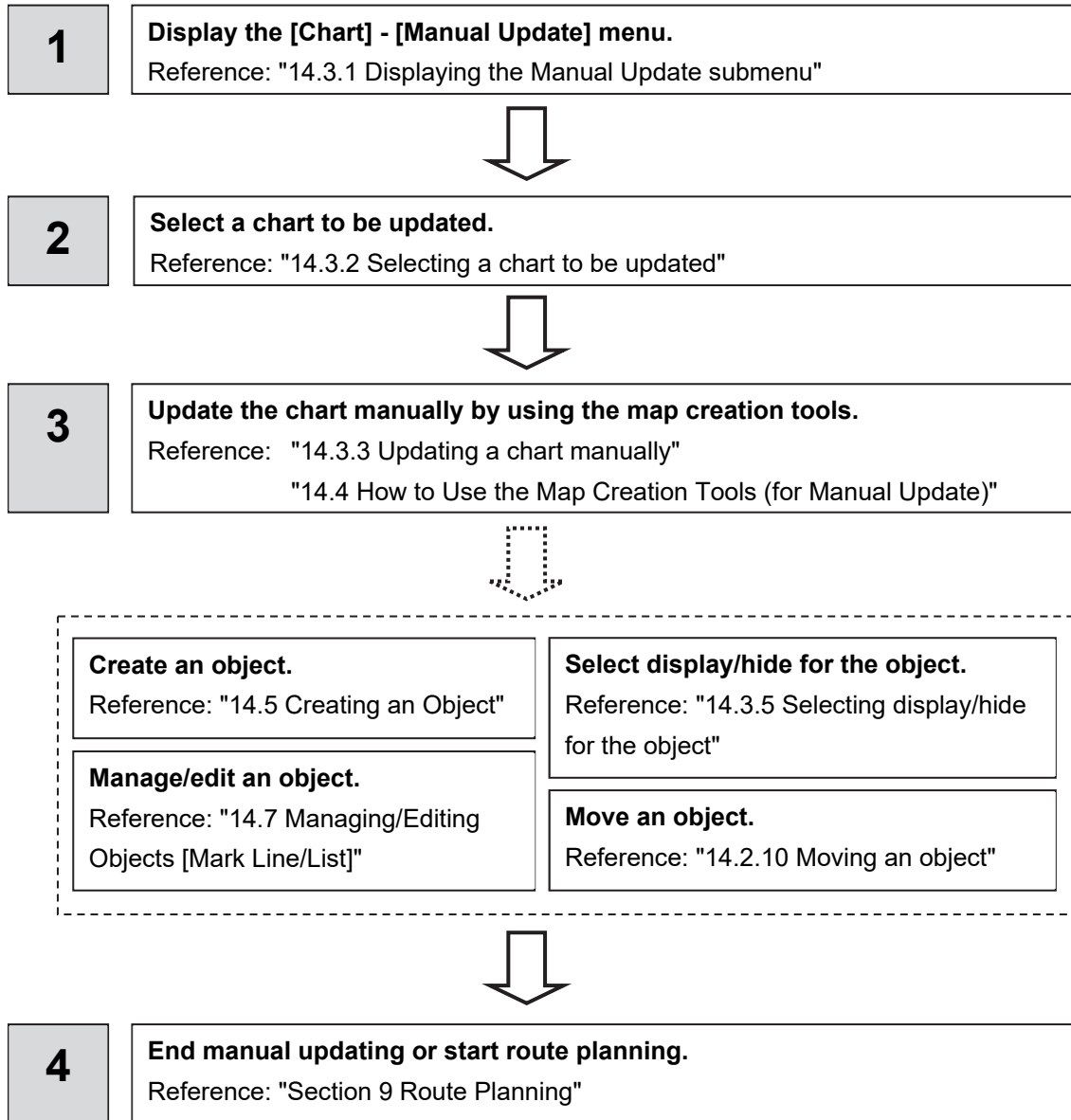

14.3.1 Displaying the Manual Update submenu

By selecting [Menu] - [Chart] - [Manual Update], the selected chart can be updated manually.

Restrictions

Multi-screen display is disabled at manual update of a chart. Even if multi-screen display is attempted prior to the commencement of manual update, the mode is switched to Single View if manual update is commenced.

Note

Since a dialog box requesting a Notice to Mariners issuing date is displayed when the updated chart is saved, enter the issuing date.

- 1 Click on the [Menu] button on the left toolbar.**
The menu is displayed.
- 2 Click on the [Chart] button on the menu.**
- 3 Click on the [Manual Update] button on the submenu.**
The "Manual Update" toolbar is displayed.

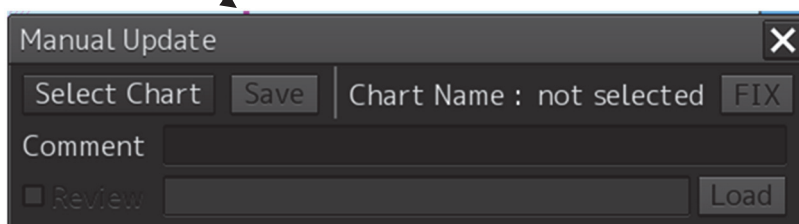
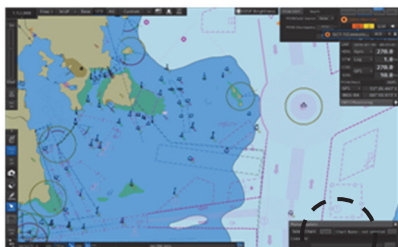

"Manual Update" toolbar

14.3.2 Selecting a chart to be updated

- 1 Click on the [Select Chart] button on the Manual Update toolbar.
The [Select Chart] dialog box appears.

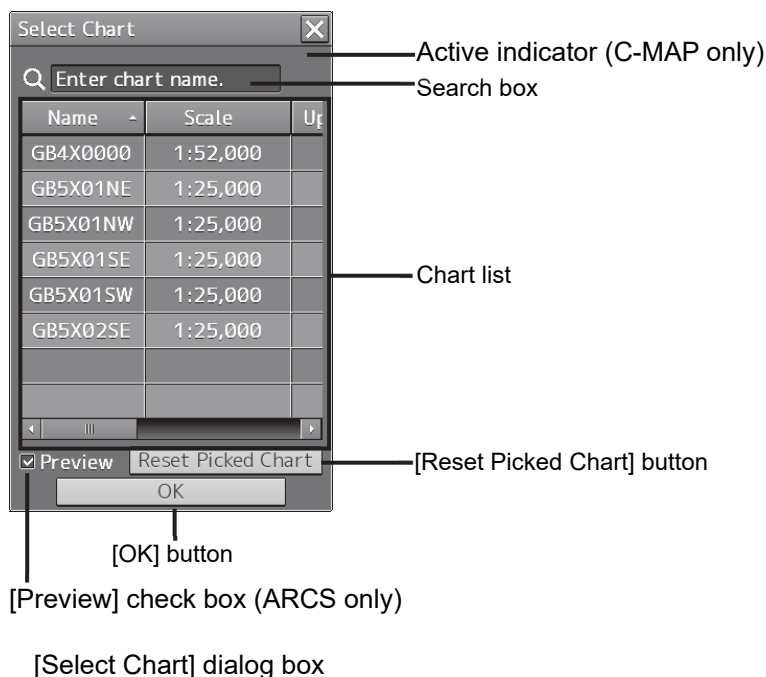

- 2 Select a chart file to be updated manually on the [Select Chart] dialog box.

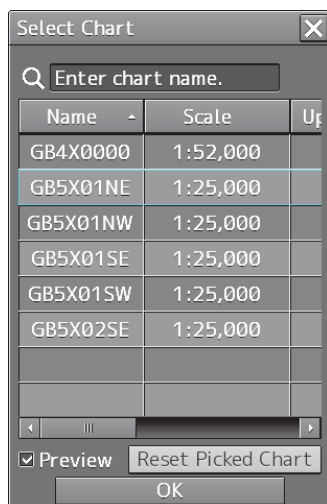

- 3 Click on the [OK] button in the [Select Chart] dialog box.
A chart is selected.

14.3.2.1 Searching the position that is clicked on with the cursor

- 1 Move the cursor to the position where manual update is to be performed and click the button.

ARCS:

All the charts that are overlaid on the position that was clicked on are displayed in the chart list.

C-MAP:

The chart that is drawn at the position that is selected by clicking is displayed in the chart list.

Memo

To clear the search result, click on the [Reset picked chart] (chart selection reset) button on the [Select Chart] dialog box.

14.3.2.2 Searching a chart with the chart name

- 1 Enter a chart name in the search box on the [Select Chart] dialog box.

The applicable chart is displayed.

Memo

To clear the search result, clear the input in the search box.

14.3.2.3 Displaying the chart screen that is selected from the list

When the target of manual update is an ARCS chart, the chart file to be updated can be displayed on the screen for verification before starting the update.

When the [Preview] check box is checked, the chart that is selected in the list is displayed at the center of the screen.

When the check box is unchecked, the display is cleared.

14.3.3 Updating a chart manually

- 1 By using map creation tools, create/edit an object on a chart. (Refer to "14.2 Using Map Creation Tools (User Chart Creation/Editing)").
- 2 Delete an object or change the properties as required. (Refer to "14.5 Creating an Object").
- 3 Click on the [Save] button.
The [Geodetic Conversion] dialog box appears.

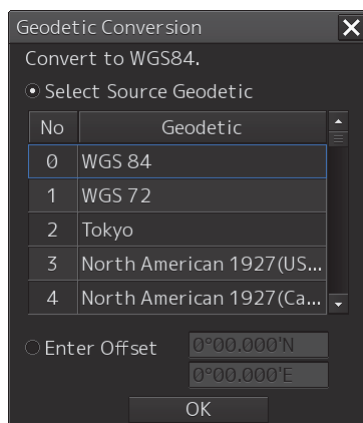

- 4 Select a datum from the list, or select [Enter Offset] and enter the offset value.
- 5 Click on the [OK] button.
- 6 The [Notice to Mariners] dialog box appears.

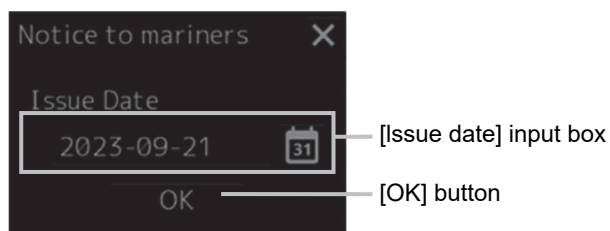

- 7 Enter a notice to mariners issuing date in the [Issue date] input box on [Notice to Mariners] dialog by using a software keyboard.
- 8 Click on the [OK] button in the [Notice to Mariners] dialog box.
The manually updated object is saved in the chart.

14.3.4 Displaying the selected chart only

Memo

For the C-MAP chart or the ARCS chart, the [FIX] button cannot be set to ON.

14.3.5 Displaying the object/redisplaying the hidden object

In the case of ARCS, to display all the objects that were created by chart manual update, select the [Display All Object] check box on the Manual Update toolbar.

To redisplay the hidden objects, select the [Display Hidden Objects] check box on the Manual Update toolbar.

14.4 How to Use the Map Creation Tools (At Manual Update of ARCS)

At chart manual update also, use the same map creation tools in the same way as that of user chart creation. (Refer to "14.2 Using Map Creation Tools (User Chart Creation/Editing)"). However, there are the following differences in the map creation tools

- The user chart information bar is not displayed.
- The object that is saved cannot be deleted by the eraser tool (can be hidden).
- A Mariner's Mark/Line drawing object cannot be selected with the drawing tool.
- More icon types can be selected in the drawing tool.

When the chart is updated manually, "Update" is displayed on the Write tool button.

Note

At chart manual update, the bearing reference mode is fixed to [N UP] mode.

14.4.1 Deleting or hiding an object

1 Click on the eraser tool button.

The cursor changes to the eraser cursor.



2 Place the eraser cursor on the object and click the button.

At manual update, only pre-saved objects can be deleted by the eraser tool.

If the saved object is clicked on with the eraser tool, the object is hidden. All the property screens of the object that has been set to hide are displayed as disable and cannot be edited.

The object that is created and saved by manual update can be redisplayed unless deleted even if it is hidden.

If the chart that uses the hidden object is updated, the expiration date of the object is set (90 days from the date on which the object is created).

The object will be deleted after the expiration date.

14.4.2 Selecting an object type

- 1 Click on the [Type] button on the drawing toolbar.

An icon list is displayed.

- 2 Select an object type by clicking on the icon on the icon list.

At manual update, the following icon list is displayed.

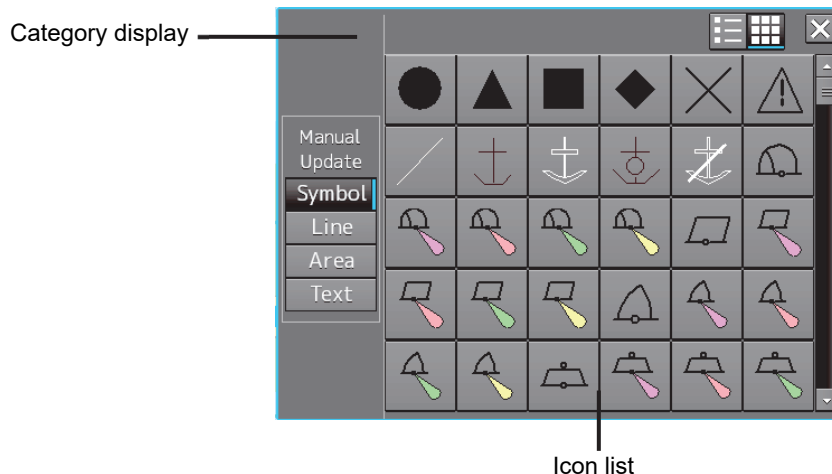

Icon list at manual update

The [Mariner's Mark/Line] button is not displayed on the icon list at manual update.

For the details of icons that can be selected from the icon list, refer to "Appendix D.6 Icon Button List for Manual Update".

14.5 Creating an Object(At Manual Update of ARCS)

This section describes the procedures for changing the parameters of the object after creating the object on the user chart or chart during manual update.

Note

After automatic sailing, the mark/line may be shifted depending on how the cursor is placed on the target at the input.

To prevent the shift, place the cursor on the front edge of the target.

- Input method that does not cause shift (place the cursor on the front edge of the target)

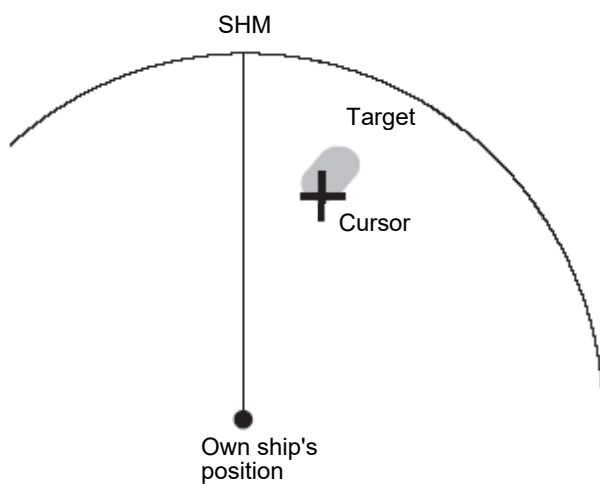

- Input method that causes shift (place the cursor on the center of the target)

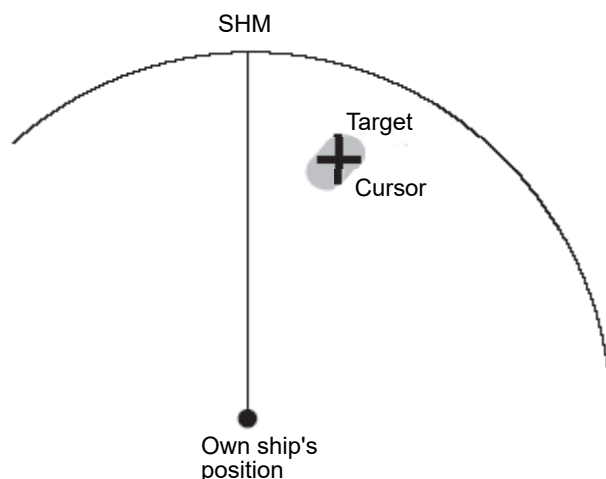

14.5.1 Creating a symbol object (Symbol)

A symbol or Alerts symbol can be created by specifying the creation position with the cursor.

- 1 Click on the [Type] button on the drawing toolbar.

An icon list is opened.

Select a symbol or an icon of Alerts symbol. (Refer to "14.2.3 Selecting an object type").

- 2 Click on the position on which the symbol is to be created with the cursor.



The symbol is displayed on the position on which the button is clicked and the parameters of the symbol that was created are displayed on the object property dialog box.

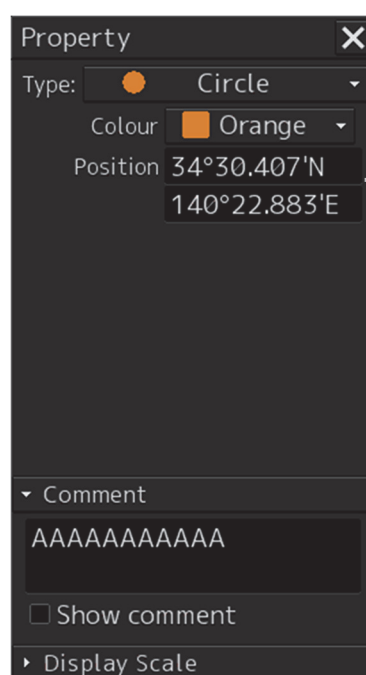
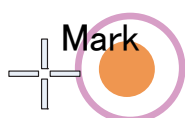

Property dialog box showing the following parameters:

- Type: Circle
- Colour: Orange
- Position: 34°30.407'N, 140°22.883'E
- Comment: AAAAAAAAAA
- Show comment:
- Display Scale:

Latitude and longitude of the symbol creation position

- 3 Adjust the parameters on the object property dialog box.
- 4 To create an object on another position continuously, repeat Steps 2 and 3.

14.5.1.1 Creating an object by specifying the latitude and longitude

- 1 Click on the [Enter POSN] button on the drawing toolbar.

The [Enter Position] dialog box appears (Refer to "14.2.6 Creating an object by specifying latitude and longitude").

- 2 Enter the latitude and longitude of the position on which an object is to be created and click on the [Enter] button.**

An object is created on the specified latitude and longitude and the property information is reflected in the object property dialog box. (Refer to "14.2.8 Object property dialog box").

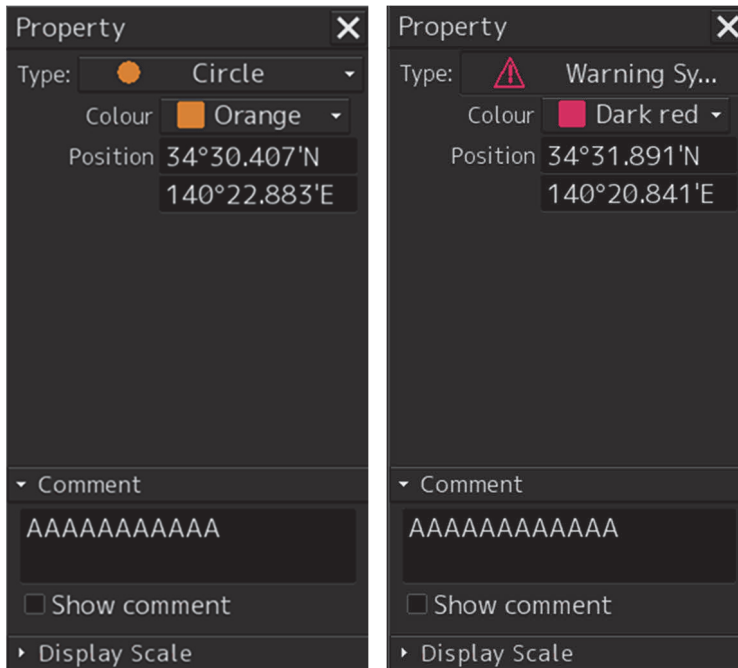

- 3 Adjust the parameters on the object property dialog box.**
- 4 To create an object on another position continuously, repeat Steps 2 and 3.**

At user chart creation, the symbol size can be changed by selecting [Option] - [User Chart] on the View menu.

For the details, refer to "16.2.6 Setting up the Display of User Chart".

14.5.1.2 Creating an object with EBL/VRM operation

- 1 Click on the [EBL/VRM] button on the drawing toolbar.**

The cursor changes to the EBL/VRM reference point cursor. (Refer to "14.2.5 Creating an object in the EBL/VRM mode").
- 2 Click on the position of the reference point of the EBL/VRM marker.**

The EBL/VRM marker is displayed.
- 3 Place the EBL/VRM marker on the position on which the object is to be created and click the button.**

An object is created on the position on which the button was clicked and the property information is reflected in the object property dialog box. (Refer to "14.2.8 Object property dialog box").
- 4 Adjust the parameters on the object property dialog box.**
- 5 To create an object on another position continuously, repeat Steps 2 to 4.**

14.5.2 Creating a simple line and Alerts line (Line object)

A simple line and Alerts line are created by using one vertex as an object. Alerts line is a line object that is detected as the warning target (danger line) of own ship.

Note

The color of Alerts line cannot be changed.

1 Click on the [Type] button on the drawing toolbar.

An icon list is opened.

Select an icon of a simple line or Alerts line. (Refer to "14.2.3 Selecting an object type").

2 Click on the starting point with the cursor.

A vertex is created and the property information of the vertex is displayed on the object property dialog box.

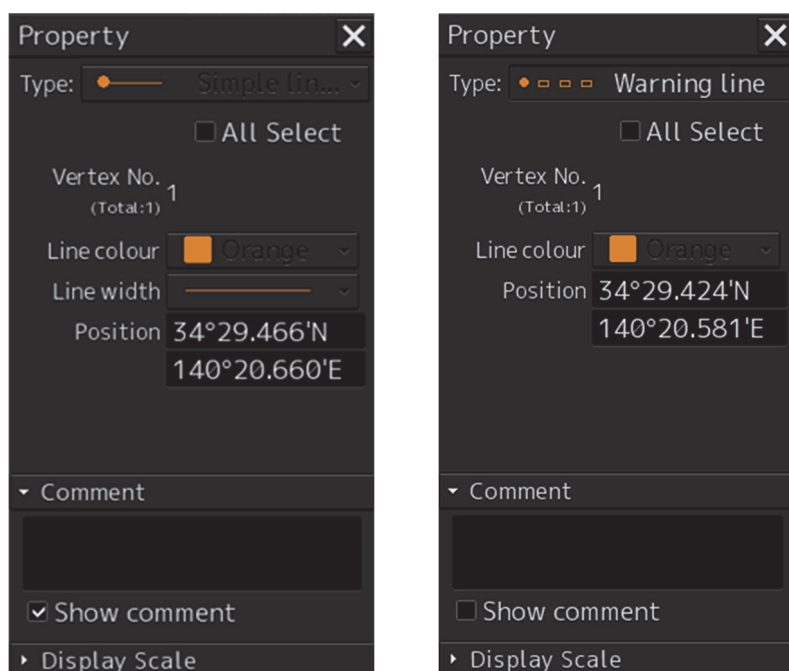

3 Move the cursor to the next vertex.

The latitude and longitude of the cursor are displayed near the cursor.



4 Click on the position on which the 2nd vertex is to be created.

A vertex is created and the parameters of the 2nd vertex are displayed on the object property dialog box.

Releasing the starting point selection state

Addition of 2nd point

Mark

The property screen is updated after the 2nd position is added.

Property

Type: Simple lin... [Type] becomes the medium point.

All Select

Vertex No. 2 The number of vertices becomes 2.
(Total:2)

Line colour Orange Editing of the line color and width is enabled.

Line width

Position 34°32.181'N The coordinates of the 2nd point are entered.
140°20.344'E

Comment

Show comment

Display Scale

5 Determine the line by double-click on the button or click the right button.

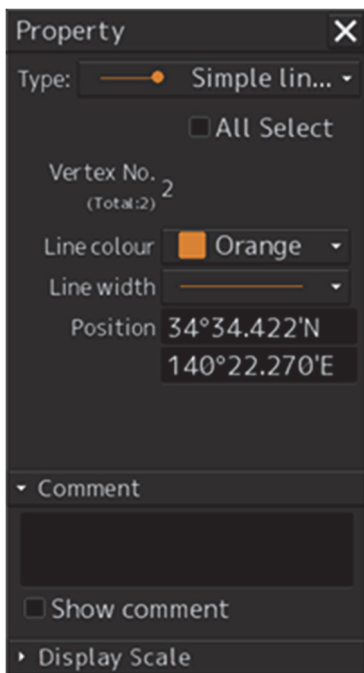
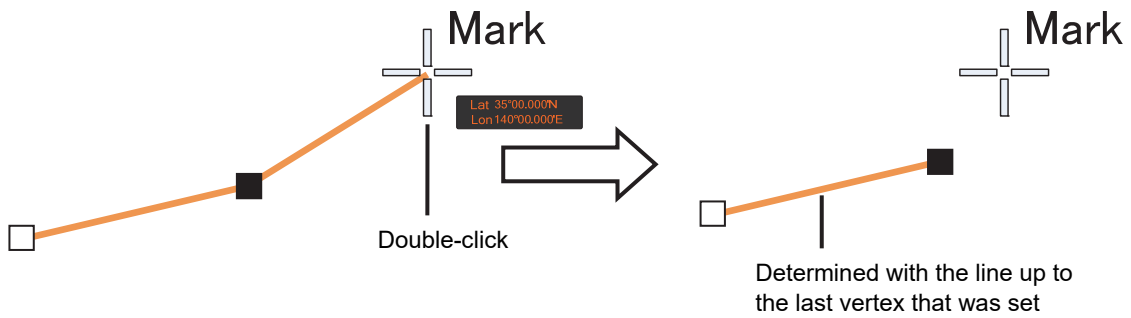

After determining of drawing, the last vertex changes to the end point.

6 Adjust the parameters on the object property dialog box.

7 To create an object on another position continuously, repeat Steps 2 to 6.

Memo

The property screen for the vertex that was created can be edited in AUTO mode.
For the details of AUTO mode, refer to "3.14 Cursor AUTO Mode".

14.5.2.1 Creating a vertex by entering the position

- 1 Click on the [Enter POSN] button on the drawing toolbar.**
The [Enter Position] dialog box appears.
- 2 Enter the latitude and longitude of the vertex of the object in the [Position] box and click on the [Enter] button.**
The position of the vertex of the object is determined.
The [Bearing] box and the [Distance] box are enabled.
- 3 Enter the values of the latitude and the longitude of the next vertex in the [Position] box. Alternatively, enter the bearing from the vertex that was determined immediately previously in the [Bearing] box and the [Distance] input box.**
- 4 Click on the [Enter] button.**
- 5 Determine the positions of 2 or more vertices by repeating Steps 2 and 3.**
- 6 Adjust the parameters on the object property dialog box.**
- 7 To create an object in another position continuously, click on the [New] button of the [Enter Position] dialog and repeat Steps from 2 to 6.**

14.5.2.2 Creating an object with EBL/VRM operation

- 1 Click on the [EBL/VRM] button on the drawing toolbar.**
The cursor changes to the EBL/VRM reference point cursor. (Refer to "14.2.5 Creating an object in the EBL/VRM mode").
- 2 Click on the position of the reference point of the EBL/VRM marker.**
The EBL/VRM marker is displayed.
- 3 Place the EBL/VRM marker on the starting point and click the button.**
A vertex is created on the position on which the button was clicked and the information is reflected in the object property dialog box. (Refer to "14.2.8 Object property dialog box").

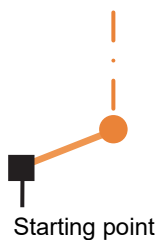

4 Click on the position of the reference point.

The EBL/VRM marker that determines the 2nd point is displayed.

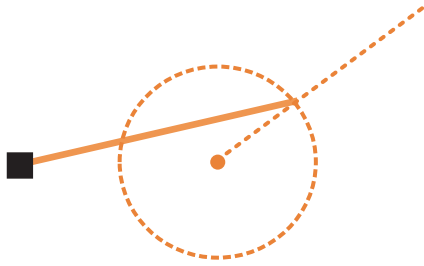

5 Place the EBL/VRM marker on the 2nd vertex and click the button.

A vertex is created on the position on which the button was clicked and the information is reflected in the object property dialog box. (Refer to "14.2.8 Object property dialog box").

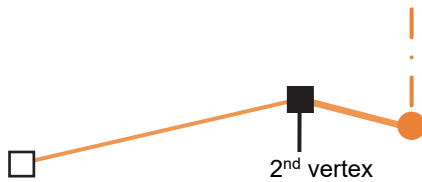

The EBL/VRM marker is reset to the EBL/VRM reference point cursor.

6 Adjust the parameters on the object property dialog box.

7 To create an object on another position continuously, repeat Steps 2 to 6.

14.5.3 Creating a circle, ellipse, and an arc (Line object)

A circle, an ellipse, and arc can be drawn with the cursor by specifying the center.

- 1 Click on the [Type] button on the drawing toolbar.**

An icon list is opened.

- 2 Select an icon of a circle, an ellipse, or an arc.**

(Refer to "14.2.3 Selecting an object type").

- 3 Click on the position for the center with the cursor.**

The center is created and the property information on the vertex is displayed on the object property dialog box.

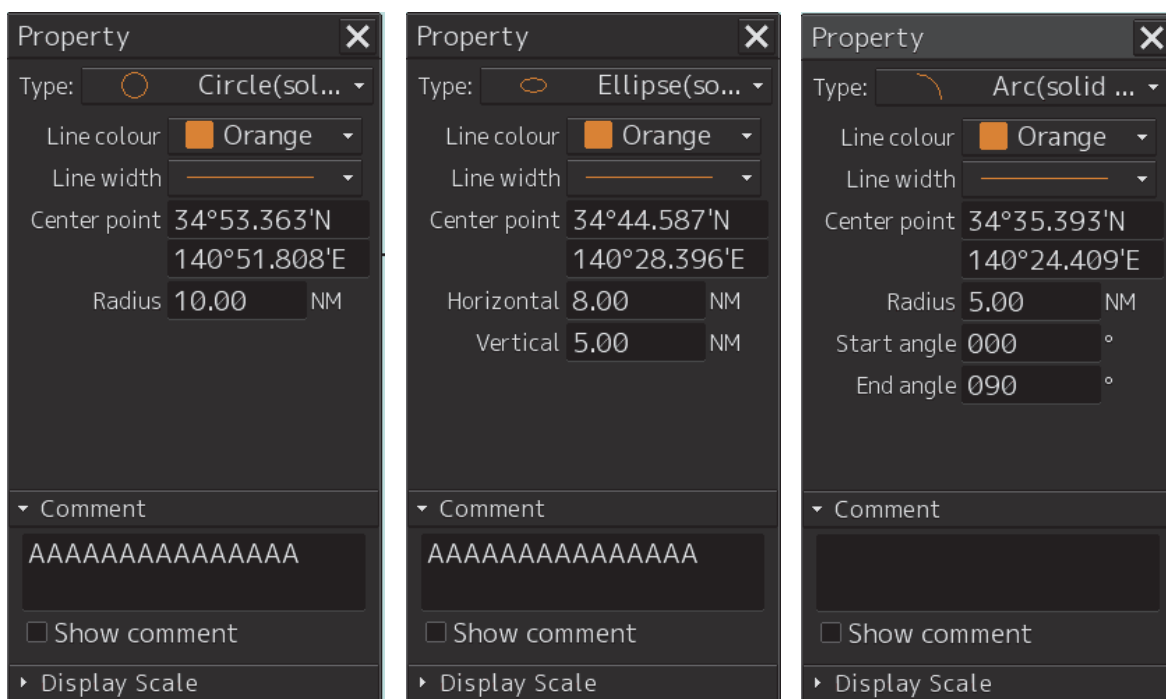

4 Draw a circle, an ellipse, or an arc.

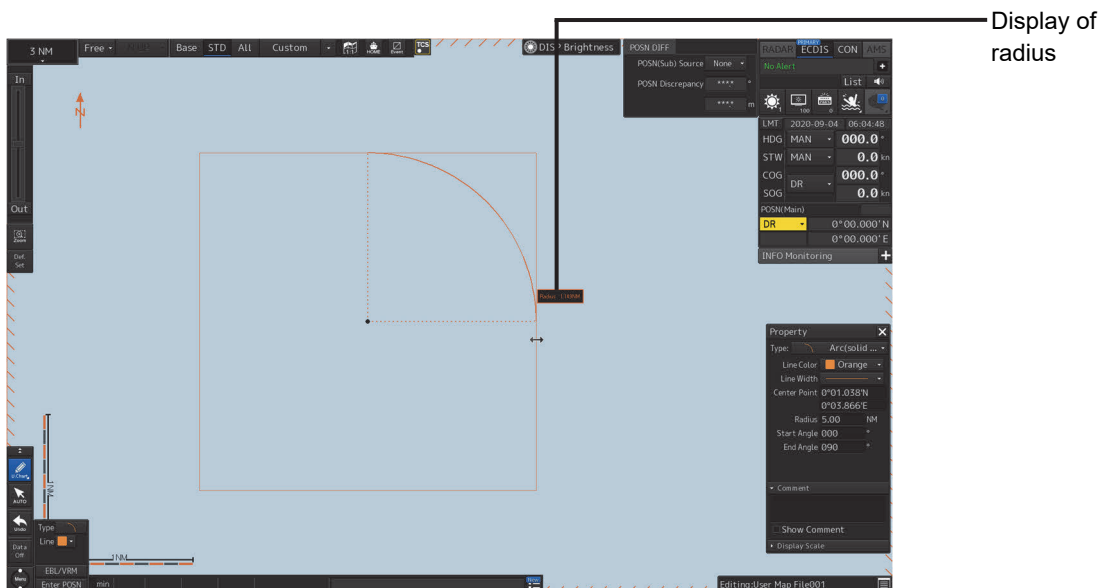
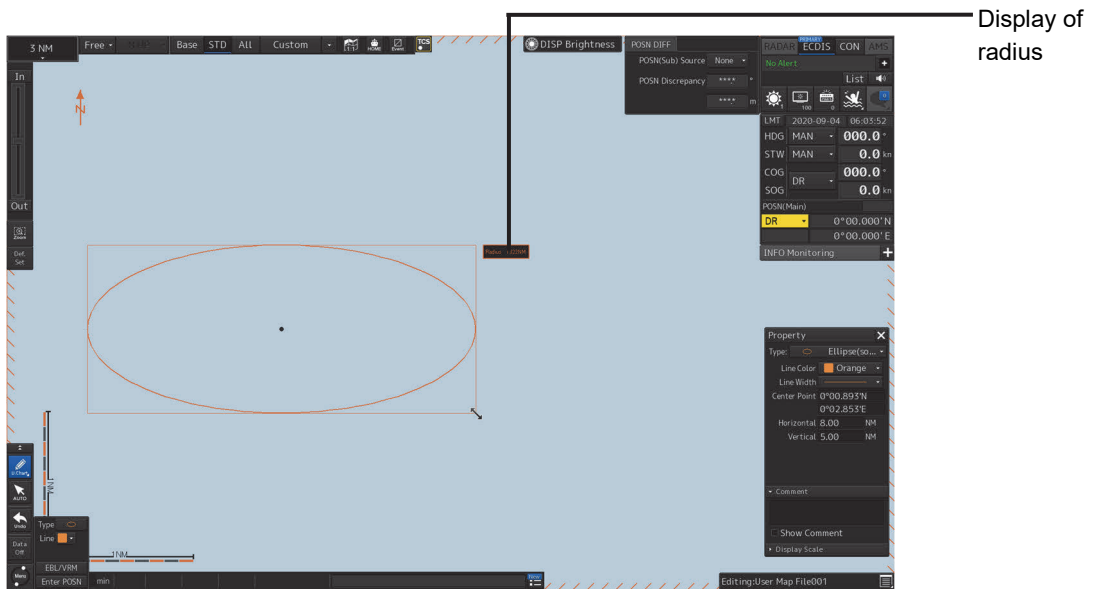
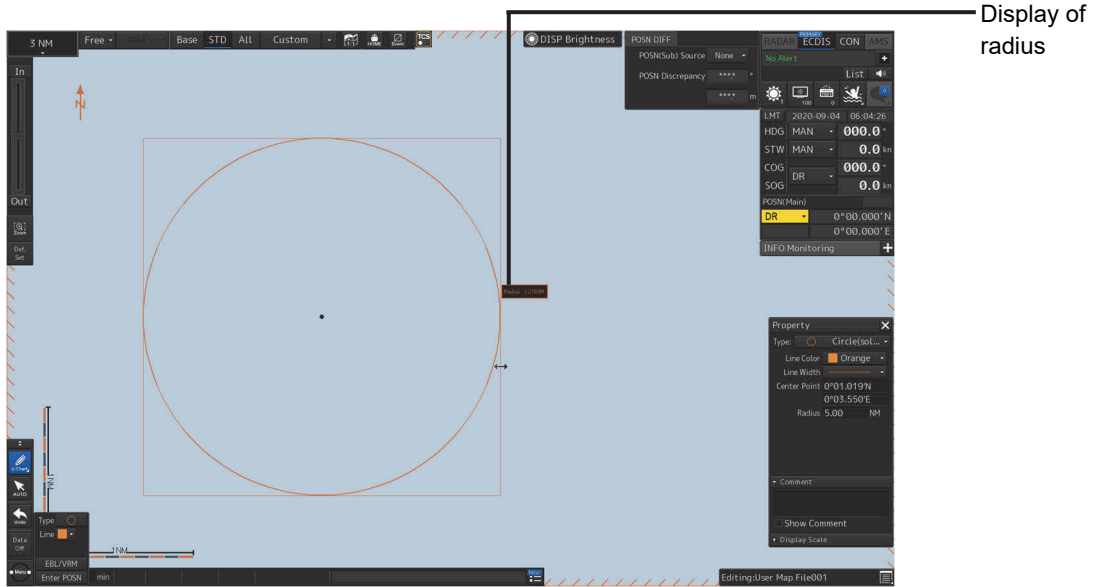

At creation of an arc, the starting angle and the ending angle of the arc to be created are the previous values or the initial values (starting angle: 0°, ending angle: 90°). To change the starting angle and the ending angle, change the values in [Start Angle] and [End Angle] on the object property dialog box.

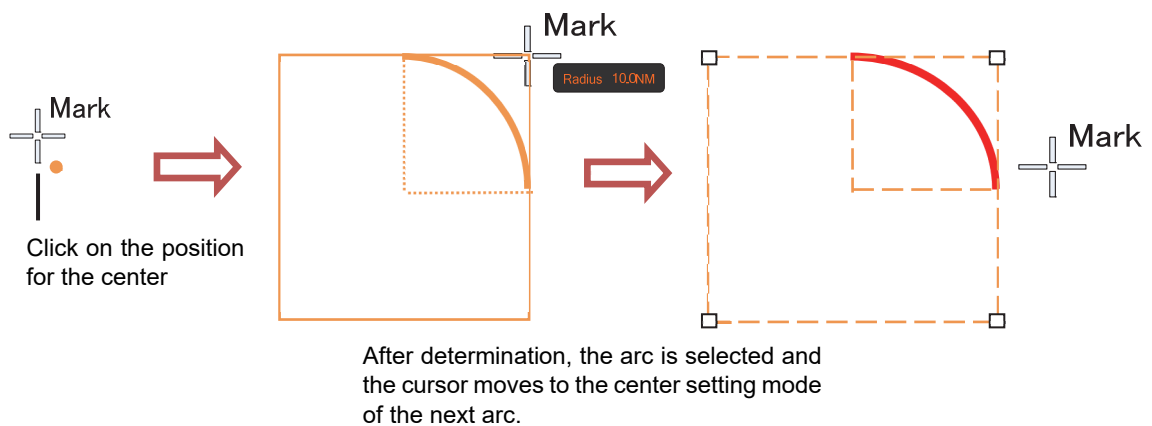

- 5 Determine the object by clicking the button again.**
- 6 Adjust the parameters on the object property dialog box.**
- 7 To create an object on another position continuously, repeat Steps 3 to 6.**

14.5.3.1 Creating an object by specifying a position for the center and size of the object

- 1 Click on the [Enter POSN] button on the drawing toolbar.**
The [Enter Position] dialog box appears (Refer to "14.2.6 Creating an object by specifying latitude and longitude").
- 2 Enter the coordinate of the center of the circle, ellipse, or arc and click on the [Enter] button of the [Enter Position] dialog box.**
The center is created at the position of the specified coordinate and the property information is reflected in the object property dialog box. (Refer to "14.2.8 Object property dialog box").
- 3 Set the parameters in the object property dialog box as indicated below.**
 - Circle: Enter a value of [Radius].
 - Ellipse: Enter values of [Horizontal] and [Vertical].
 - Arc: Enter values of [Radius], [Start Angle], and [End Angle].
- 4 To create an object on another position continuously as required, repeat Steps 2 and 3.**

14.5.4 Creating a polygon and Alerts area (Area object)

Create a polygon using all the vertices (3 or more) as one object. Alerts area is an area object that is detected as a warning target (danger area).

A polygon and Alerts area can be created in the same way as for simple line and Alerts line

1 Click on the [Type] button on the drawing toolbar.

An icon list is opened.

Select an icon of a polygon or Alerts area. (Refer to "14.2.3 Selecting an object type").

2 Click on the starting point position with the cursor.

The starting point is created and the property information of vertex 1 is displayed on the object property dialog box.

The left screenshot shows the Property dialog box for a Polygon(s...). The Type is set to Polygon(s...). The Line colour is Orange, Line width is set, Fill colour is Blue, and Transparency is 75%. The Vertex (Total:1) table has one row with No. 1, LAT 34°36.934'N, and LON 141°03.79.

The right screenshot shows the Property dialog box for a Warning d... The Type is set to Warning d... The Line colour is Dark red, Line width is set, Fill colour is Dark red, and Transparency is 75%. The Vertex (Total:1) table has one row with No. 1, LAT 34°43.571'N, and LON 141°19.6. A callout points to the LAT and LON values in the table, stating: "The latitude and longitude of the starting point (vertex 1) are displayed."

3 Move the cursor to the next vertex.

The latitude and longitude of the cursor are displayed near the cursor.



4 Click on the position on which the 2nd vertex is to be created.

A vertex is created and the latitude and the longitude of the 2nd vertex are displayed on the object property dialog box

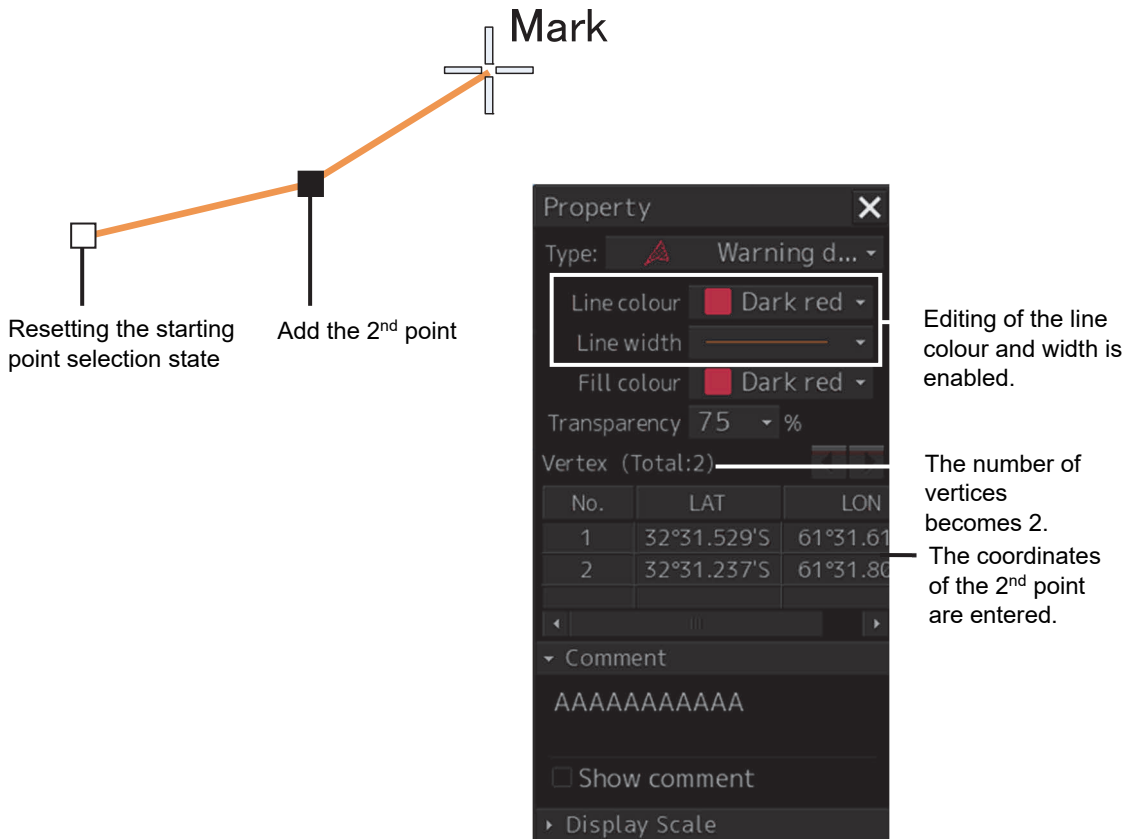

Resetting the starting point selection state

Add the 2nd point

Mark

Property

Type: Warning d...

Line colour: Dark red

Line width: [Slider]

Fill colour: Dark red

Transparency: 75 %

Vertex (Total:2)

No.	LAT	LON
1	32°31.529'S	61°31.61
2	32°31.237'S	61°31.80

Comment: AAAAAAAAAA

Show comment

Display Scale

Editing of the line colour and width is enabled.

The number of vertices becomes 2.

The coordinates of the 2nd point are entered.

5 Click on the position on which the 3rd vertex is to be created.

A triangle is created by connecting the three vertices. A preview screen is displayed, enabling the checking of the fill statuses of the polygon and t Alerts area.

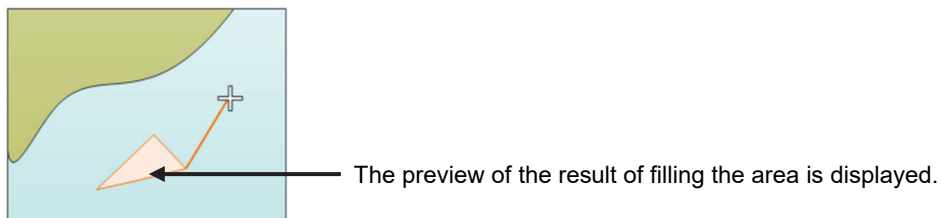

The preview of the result of filling the area is displayed.

The latitude and longitude of the 3rd vertex are displayed on the object property dialog box.

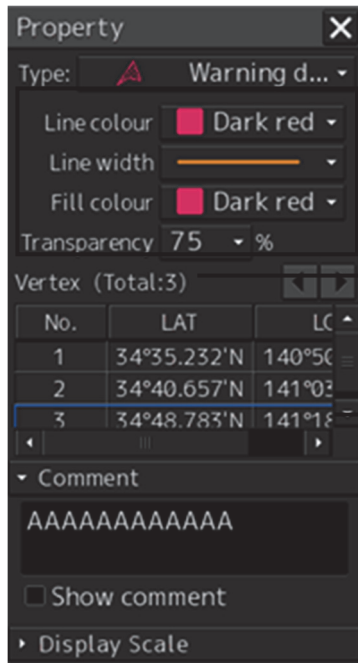

The editing of the line color, line width, fill colour, and transparency is enabled.

The number of vertices becomes 3.

The coordinates of the 3rd vertex are entered.

- 6 To add another vertex continuously, click on the position on which the vertex is to be created.**

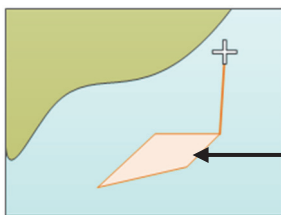

When the 4th vertex is determined, the preview display is updated.

When not adding any further vertices, determine the polygon or Alerts area by double-clicking the button or clicking the right button.

- 7 Adjust the parameters on the object property dialog box.**
- 8 To create an object on another position continuously, repeat Steps 2 to 7.**

14.5.4.1 Creating a vertex by entering the position

- 1 Click on the [Enter POSN] button on the drawing toolbar.**
The [Enter Position] dialog box appears.
- 2 Enter the latitude and longitude of the vertex of the object in the [Position] box and click on the [Enter] button.**
The position of one vertex of the object is determined.
The [Bearing] box and the [Distance] box are enabled.
- 3 Enter the values of the latitude and the longitude of the next vertex in the [Position] box. Alternatively, enter the bearing from the vertex that was determined immediately previously in the [Bearing] box and the [Distance] input box.**
- 4 Click on the [Enter] button.**

-
-
- 5** Determine 3 or more vertices by repeating Steps 2 to 4.
 - 6** Adjust the parameters on the object property dialog box.
 - 7** To create an object on another position continuously, repeat Steps 2 to 6.

14.5.4.2 Creating an object with EBL/VRM operation

- 1** Click on the [EBL/VRM] button on the drawing toolbar.
The cursor changes to the EBL/VRM reference point cursor. (Refer to "14.2.5 Creating an object in the EBL/VRM mode").
- 2** Click on the position of the reference point of the EBL/VRM marker.
The EBL/VRM marker is displayed.
- 3** Place the EBL/VRM marker on the starting position and click the mouse button.
A vertex is created on the position on which the button was clicked and the parameter information is reflected on the object property dialog box. (Refer to "14.2.8 Object property dialog box").

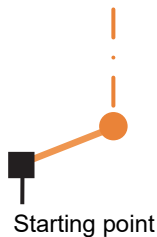

- 4** Click on the position of the reference point.
The EBL/VRM marker that determines the 2nd vertex is displayed.

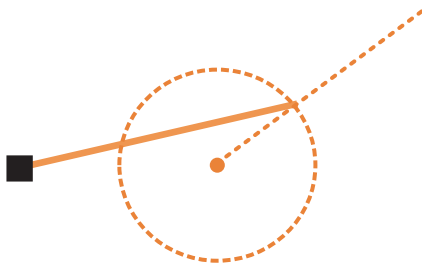

- 5** Place the EBL/VRM marker on the 2nd vertex position and click the button.
A vertex is created on the position on which the button was clicked and the property information is reflected in the object property dialog box. (Refer to "14.2.8 Object property dialog box").

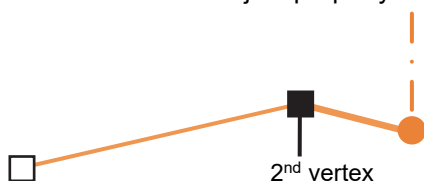

The EBL/VRM marker is reset to the EBL/VRM reference point cursor.

6 Place the EBL/VRM marker on the position of the 3rd vertex and click the button.

A triangle is created by connecting the three vertices. The preview screen is displayed, enabling the checking of the fill state of the polygon and Alerts area.

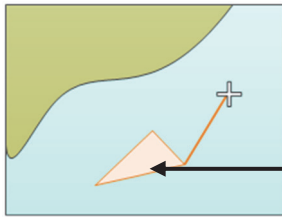

Preview of the area fill result is displayed.

7 Adjust the parameters on the object property dialog box.

8 To create an object on another position continuously, repeat Steps 1 to 7.

Note

If you create an area with a single stroke in counterclockwise direction, the area may not be detected.

When creating an area with a single stroke, please make it in clockwise direction.

14.5.5 Creating circle, ellipse, and fan areas (Area object)

Circle, ellipse, and fan areas can be created in the same way as for creating a circle, an ellipse, or an arc of the Line object.

- 1 Click on the [Type] button on the drawing toolbar.**
An icon list is opened.
- 2 Select an icon of circle, ellipse, or arc. (Refer to "14.2.3 Selecting an object type")**
- 3 Click on the position to be the center with the cursor.**
A center is created and the vertex property information is displayed on the object property dialog box.

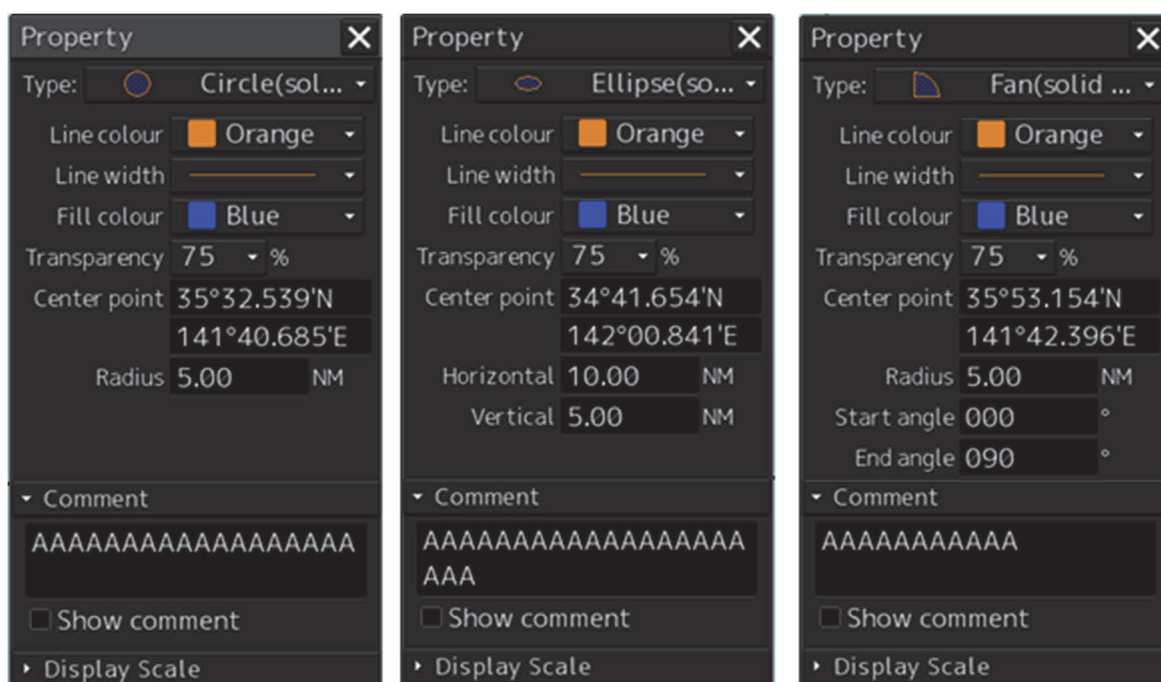

4 Draw a circle, an ellipse, and an arc.

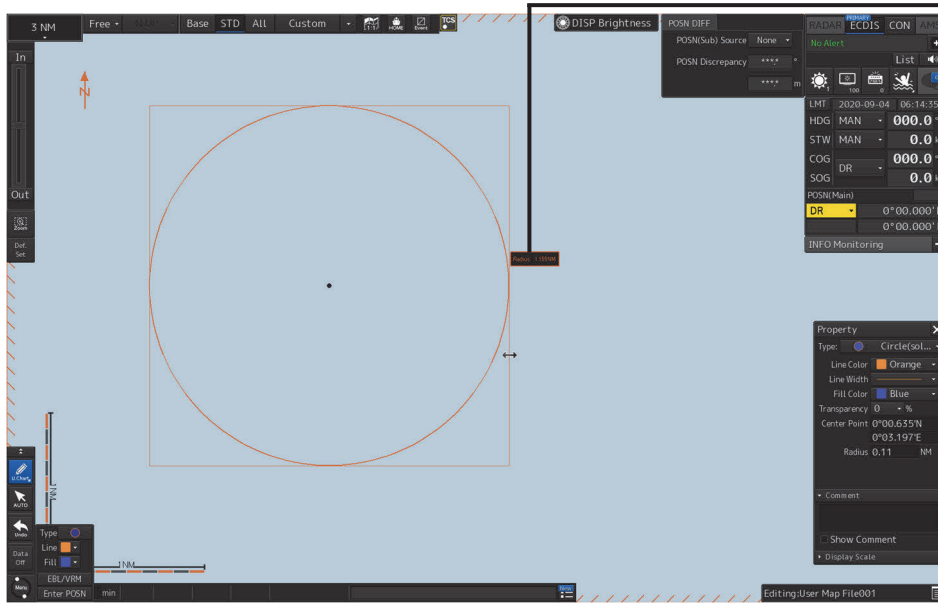

Display of radius

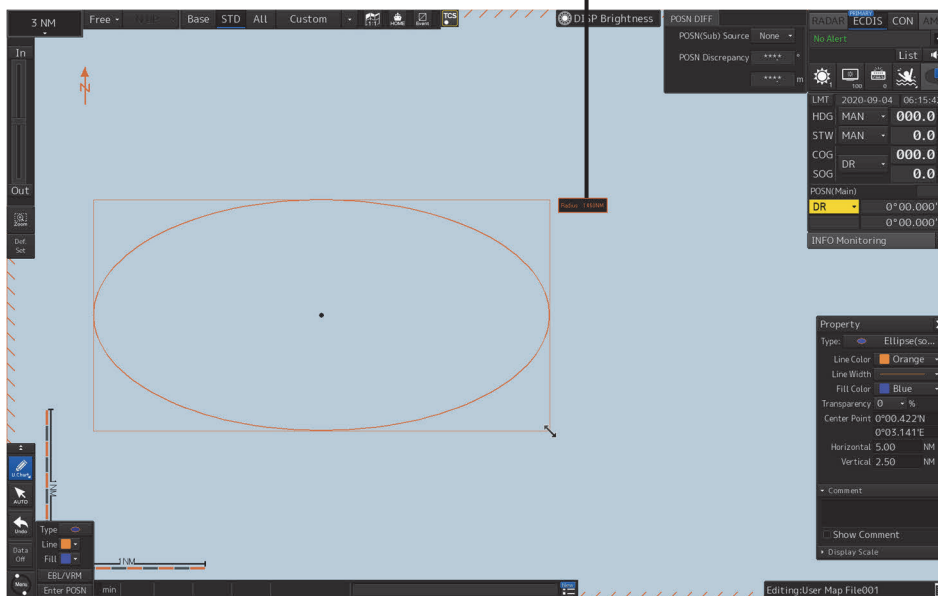

Display of radius

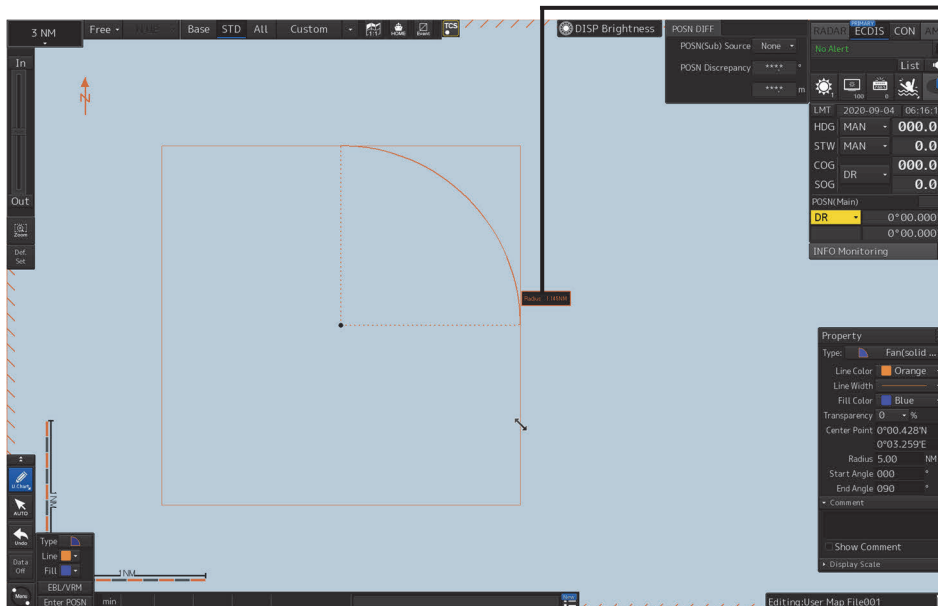

Display of radius

At creation of an arc, the starting angle and the ending angle of the arc to be created are the previous values or the initial values (starting angle: 0°, ending angle: 90°). To change the starting angle and the ending angle, change the values in [Start Angle] and [End Angle] on the object property dialog box.

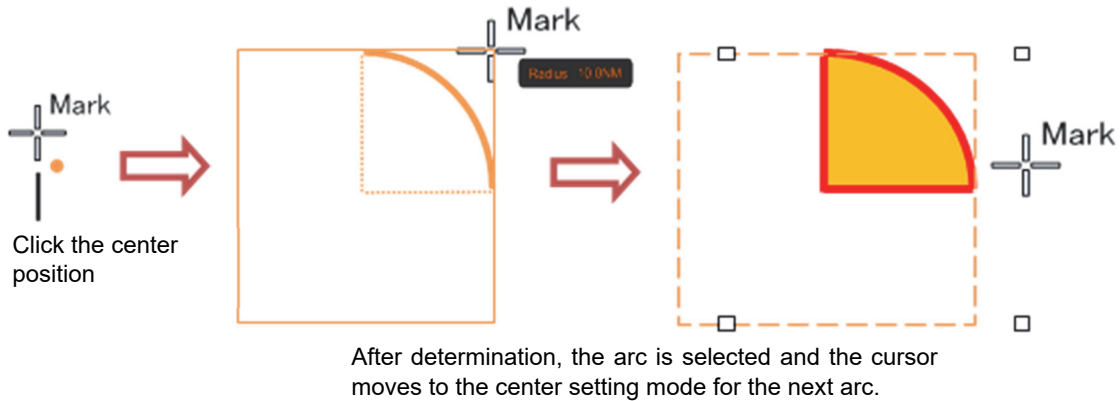

- 5 Determine the object by clicking the button again.
- 6 Adjust the parameters on the object property dialog box.
- 7 To create an object on another position continuously, repeat Steps 3 to 6.

14.5.5.1 Creating an object by specifying the center position and the object size

- 1 Click on the [Enter POSN] button on the drawing toolbar.
The [Enter Position] dialog box appears (Refer to "14.2.6 Creating an object by specifying latitude and longitude").
- 2 Enter the coordinates of the center of the circle, ellipse, or arc and click on the [Enter] button on the [Enter Position] dialog box.
A center point is created on the position of the specified coordinates and the property information is reflected in the object property dialog box (Refer to "14.2.8 Object property dialog box").
- 3 Set the following parameters on the object property dialog box.
 - Circle: Enter a value of [Radius].
 - Ellipse: Enter values of [Horizontal] and [Vertical].
 - Arc: Enter values of [Radius], [Start Angle], and [End Angle].
- 4 To create an object on another position continuously as required, repeat Steps 2 and 3.

14.5.6 Creating a text (Text object)

Any character information can be displayed on the user chart.

1 Click on the [Type] button on the drawing toolbar.

An icon list is opened.

Select a text (Txt) icon. (Refer to "14.2.3 Selecting an object type").

2 With the cursor, click on the position on which an object is to be created.



A text box is created at the position on which the button was clicked and a text is displayed.



The parameters of the text that was created are displayed on the object property dialog box.

Select a character colour from the list.

Select a character size from the list.

Enter the coordinates of the text display position.

Enter the angle from the 12 O'clock bearing when angling the text.

Enter a text (up to 64 characters).

To use a template, select a template from the list by clicking the button.

3 Adjust the parameters on the object property dialog box.

For the text input method, refer to "14.5.6.3 Editing a text", for the template usage method, refer to "14.5.6.4 Editing a template", and for the text angling method, refer to "14.5.6.5 Changing a text angle".

4 To create an object on another position continuously, repeat Steps 2 and 3.

14.5.6.1 Creating a text by specifying the latitude and longitude

1 Click on the [Enter POSN] button on the drawing toolbar.

The [Enter Position] dialog box appears (Refer to "14.2.6 Creating an object by specifying latitude and longitude").

2 Enter the latitude and longitude of the object to be created and click on the [Enter] button.

An object is created on the specified latitude and longitude and the property information is reflected in the object property dialog box. (Refer to "14.2.8 Object property dialog box").

3 Adjust the parameters on the object property dialog box.

For the text input method, refer to "14.5.6.3 Editing a text", for the template usage method, refer to "14.5.6.4 Editing a template", and for the text angling method, refer to "14.5.6.5 Changing a text angle".

4 To create an object on another position continuously, repeat steps 2 and 3.

14.5.6.2 Creating a text with EBL/VRM operation

1 Click on the [EBL/VRM] button on the drawing toolbar.

The cursor changes to the EBL/VRM reference point cursor. (Refer to "14.2.5 Creating an object in the EBL/VRM mode").

2 Click on the position of the reference point position of the EBL/VRM marker.

The EBL/VRM marker is displayed.

3 Place the EBL/VRM marker on the position on which an object is to be created and click the button.

An object is created on the position on which the button was clicked and the property information is reflected in the object property dialog box. (Refer to "14.2.8 Object property dialog box").

4 Adjust the parameters on the object property dialog box.

For the text input method, refer to "14.5.6.3 Editing a text", for the template usage method, refer to "14.5.6.4 Editing a template", and for the text angling method, refer to "14.5.6.5 Changing a text angle".

5 To create an object on another position continuously, repeat Steps 2 to 4.

14.5.6.3 Editing a text

1 Click on the [Text] input box

A character input full keyboard is displayed.

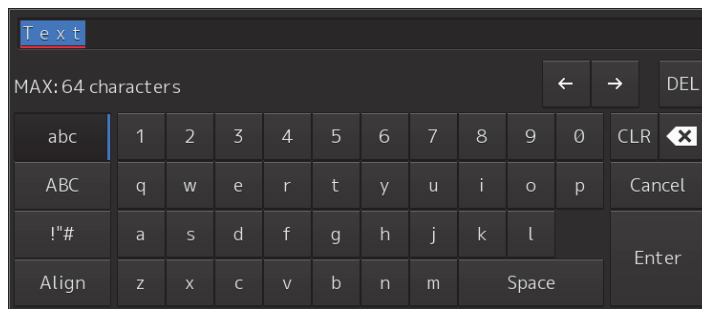

2 Create a text.

For the method of using the character input full keyboard, refer to "3.16.2 Name and function of each section of the keyboard".

3 Close the character input full keyboard by clicking on the [Enter] key.

4 To change a character color, select a required character color from the [Color] combo box.

5 To change a character size, select a required character size from the [Font size] combo box.

14.5.6.4 Editing a template

By registering a frequently used text as a template, the template can be used at text creation.

1 Click on the [Edit Template] button.

The [Template] dialog box appears.

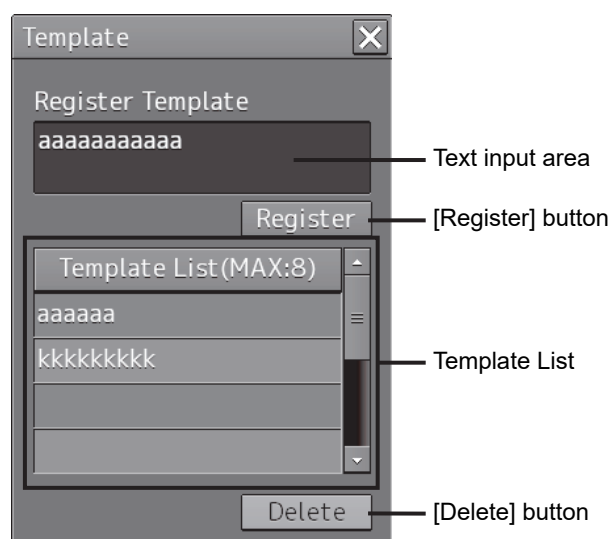

2 Click on a text input area.

A character input full keyboard is displayed.

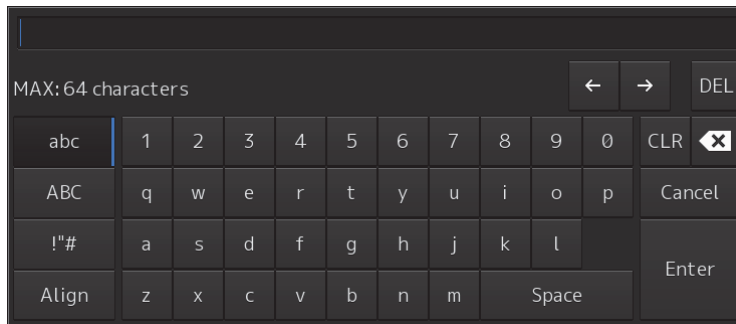

3 Create a text.

For the method of using the character input full keyboard, refer to "3.17.2 Name and function of each section of the keyboard".

4 Close the character input full keyboard by clicking on the [Enter] key.

5 Click on the [Register] button.

6 Close the [Template] dialog and click on [▼] on the right side of the text input area of the object properties dialog.

[Template List] is displayed.

7 Select any template.

8 To delete unnecessary templates, select unnecessary templates in the [Template List] and click on the [Delete] button.

14.5.6.5 Changing a text angle

Under the factory setting, a text is oriented horizontally. The text can be angled or inverted according to the text creation position.

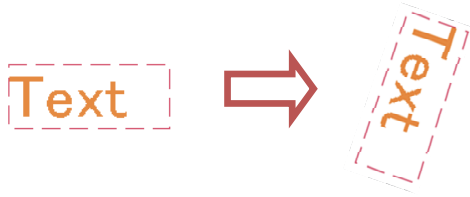

1 Click on the [Angle] input box.

A numeric value input keyboard is displayed.

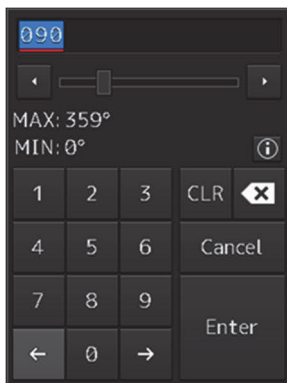

2 Enter an angle.

Specify an angle in clockwise based on the direction of the 12 O'clock as 0°. Under the factory setting, the angle is set to 90° (horizontal).

For the method of using the numeric value input keyboard, refer to "3.17.2 Name and function of each section of the keyboard".

14.5.7 Creating an arrow (Line object)

An arrow can be displayed on the user chart or chart.

- 1 Click on the [Type] button on the drawing toolbar.**

An icon list is displayed.

- 2 Select the arrow icon. (Refer to "14.2.3 Selecting an object type")**

- 3 Click on the starting position with the cursor.**

A starting point is created and the property information of the starting point is displayed on the object property dialog box.

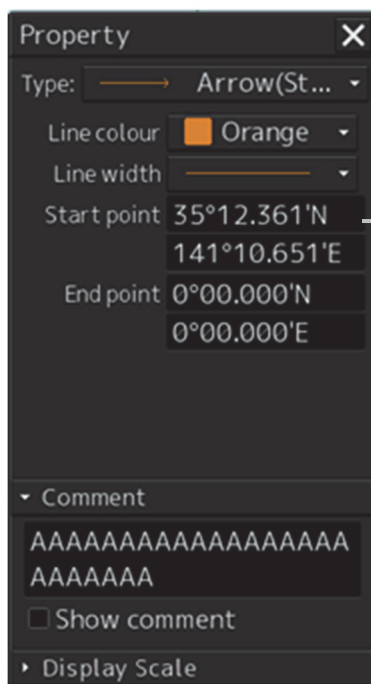
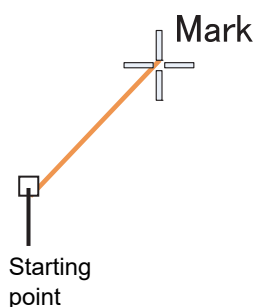

Latitude and longitude of starting point

Note

The colour, line type, and line width of a starting point cannot be changed.

4 Click on the position of the ending point with the cursor.

An ending point is created and the property information of the ending point is displayed on the object property dialog box.

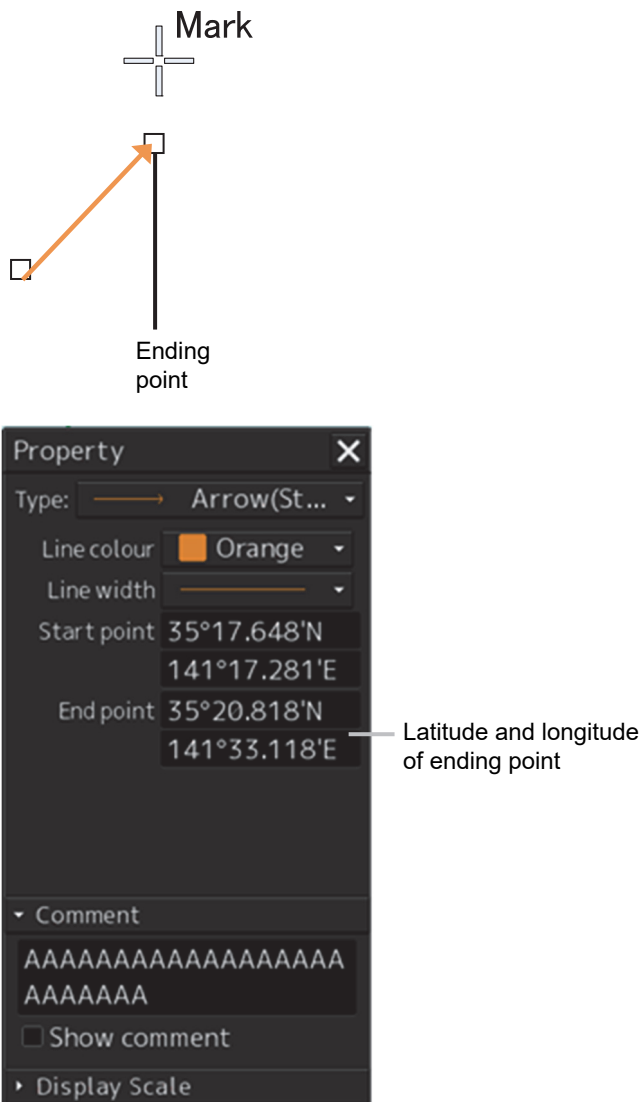

5 Adjust the parameters on the object property dialog box.

6 To create an object on another position continuously, repeat Steps 3 to 5.

14.5.7.1 Creating an object by specifying the starting point/ending point position coordinates

1 Click on the [Enter POSN] button on the drawing toolbar.

The [Enter Position] dialog box appears (Refer to "14.2.6 Creating an object by specifying latitude and longitude").

2 Enter the coordinates of the starting point and click on the [Enter] button.

A starting point of the arrow is created on the position of the specified coordinates and the property information is reflected in the object property dialog box. (Refer to "14.2.8 Object property dialog box").

3 Enter the coordinates of the ending point and click on the [Enter] button.

An ending point of the arrow is created on the position of the specified coordinates and the property information is reflected in the object property dialog box.

4 To create an object on another position continuously, repeat Steps 1 to 3.

14.5.7.2 Drawing an object with EBL/VRM operation

1 Click on the [EBL/VRM] button on the drawing toolbar.

The cursor changes to the EBL/VRM reference point cursor. (Refer to "14.2.5 Creating an object in the EBL/VRM mode").

2 Click on the position of the reference point of the EBL/VRM marker.

The EBL/VRM marker is displayed.

3 Place the EBL/VRM marker on the position of the starting point and click the button.

4 Click on the reference position of the EBL/VRM marker.

A starting point is created on the position on which the button was clicked and the property information is displayed on the object property dialog box. (Refer to "14.2.8 Object property dialog box").

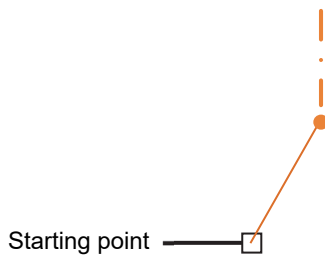

5 Place the EBL/VRM marker on the position of the ending point and click the button.

An ending point is created on the position on which the button was clicked and the property information is displayed on the object property dialog box. (Refer to "14.2.8 Object property dialog box").

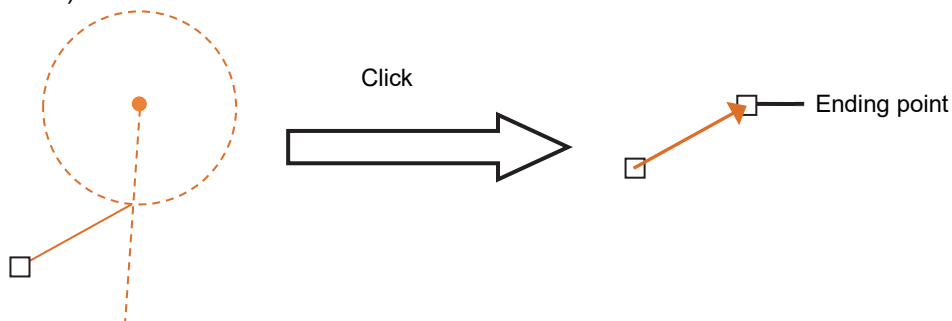

6 To create an object on another position continuously, repeat Steps 2 to 5.

14.5.8 Creating Mariner's Mark/Line drawing objects (ECDIS screen only)

At user chart creation, the following Mariner's Mark/Line drawing objects can be created.

- Information Mark
- Clearing Line
- Tidal Stream mark
- Highlight mark

1 Click on the [Type] button on the drawing toolbar.

An icon list is displayed.

2 Click on the [Mariner's Mark/Line] button on the icon list.

Mariner's Mark/Line drawing objects are displayed on the icon list.

3 Select an object to be created and specify a creation position.

14.5.8.1 Information mark

An information mark can be created on any position of the chart. An information mark is used for comments and so on.



Information
Mark

1 Click on the [Type] button on the drawing toolbar.

An icon list is opened.

Select the icon of information mark. (Refer to "14.2.3 Selecting an object type").

- 2 Click on the position on which the information mark is to be created with the cursor.



The information mark is displayed on the position on which the button was clicked and the parameters of the information mark are displayed on the object property dialog box.

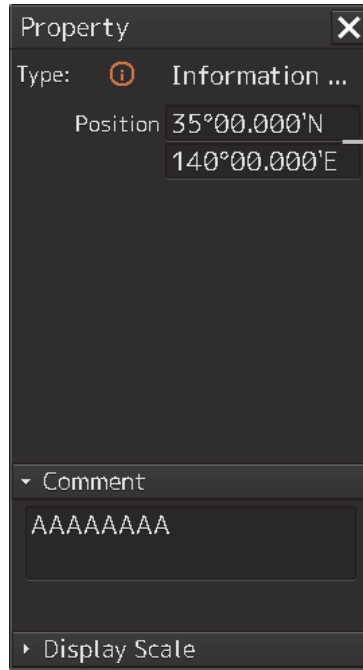

Latitude and longitude of the information mark creation position

- 3 Adjust the parameters on the object property dialog box.
- 4 To create an object on another position continuously, repeat Steps 2 and 3.

Creating an object by specifying the latitude and longitude

- 1 Click on the [Enter POSN] button on the drawing toolbar.
The [Enter Position] dialog box appears (Refer to "14.2.6 Creating an object by specifying latitude and longitude").
- 2 Enter the latitude and longitude of the position on which an object is to be created and click on the [Enter] button.
An object is created on the position of the specified latitude and longitude and the property information is reflected in the object property dialog box. (Refer to "14.2.8 Object property dialog box").
- 3 Adjust the parameters on the object property dialog box.
- 4 To create an object on another position continuously, repeat Steps 2 and 3.

Creating an object with EBL/VRM operation

- 1 Click on the [EBL/VRM] button on the drawing toolbar.**

The cursor changes to the EBL/VRM reference point cursor. (Refer to "14.2.5 Creating an object in the EBL/VRM mode").
- 2 Click on the position of the reference point of the EBL/VRM marker.**

The EBL/VRM marker is displayed.
- 3 Place the EBL/VRM marker on the position on which an object is to be created and click the button.**

An object is created on the position on which the button was clicked and the property information reflected in the object property dialog box. (Refer to "14.2.8 Object property dialog box").
- 4 Adjust the parameters on the object property dialog box.**
- 5 To create an object on another position continuously, repeat Steps 2 to 4.**

14.5.8.2 Clearing line

A clearing line can be created on a chart. It is possible to select an angle and either Not Less Than (NLT) or Not More Than (NMT) for a clearing line on the object property dialog box.

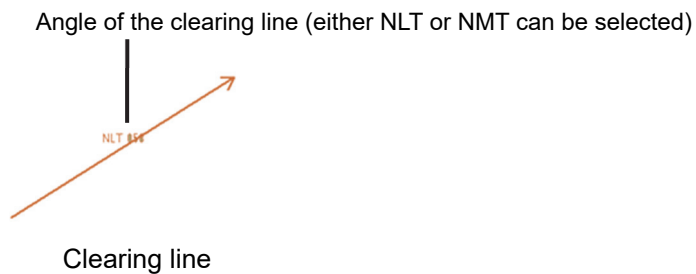

- 1 Click on the [Type] button on the drawing toolbar.**

Open the icon list and select an icon of clearing line. (Refer to "14.2.3 Selecting an object type").
- 2 Click on the position of a starting point with the cursor.**

A starting point is created and the property information of the clearing line is displayed on the object property dialog box.

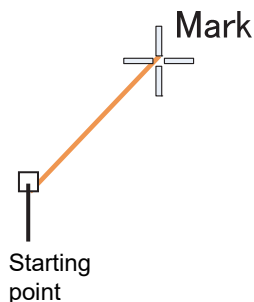

3 Click on the position of the ending point with the cursor.

An ending point is created and the property information in the object property dialog box is updated.

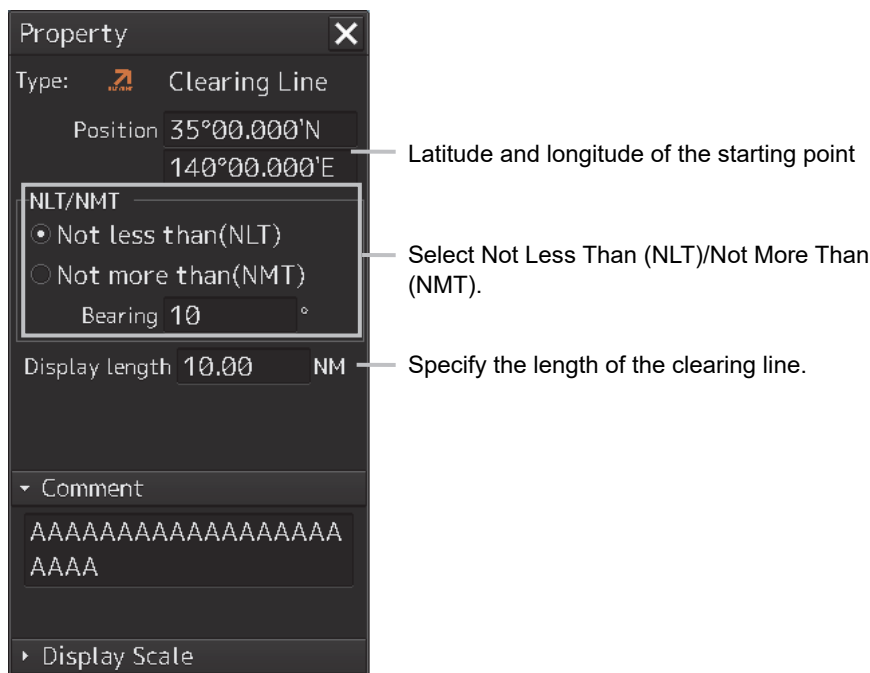
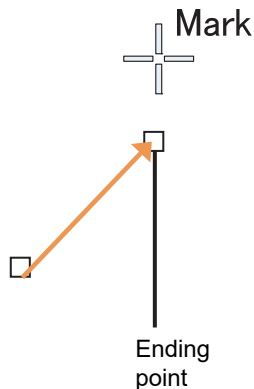

4 Adjust the parameters on the object property dialog box.

- **Specifying an angle of a clearing line:** Display a numeric value input keyboard by clicking on the [Bearing] input box and enter an angle (0 to 359°).
- **Specifying a length of a clearing line:** Display a numeric value input keyboard by clicking on the [Display length] input box and enter a length (0 to 999.99).
- **Selecting Not Less Than (NLT)/Not More Than (NMT):** Set Not Less Than (NLT) or Not More Than (NMT) to On by clicking on the button.

When Not Less Than (NLT) is selected, "NLTxx" is displayed for the clearing line, indicating that the line must not be below "xx". When Not More Than (NMT) is selected, "NMT xx" is displayed for the clearing line, indicating that the line must not exceed "xx".

For the method of using the numeric value input keyboard, refer to "3.17.2 Name and function of each section of the keyboard".

5 To create an object on another position continuously, repeat Steps 2 to 4.

Creating position coordinates of the starting point

- 1 Click on the [Enter POSN] button on the drawing toolbar.**

The [Enter Position] dialog box appears (Refer to "14.2.6 Creating an object by specifying latitude and longitude").
- 2 Enter the coordinates of a starting point and click on the [Enter] button.**
- 3 To create an object on another position continuously, repeat Steps 1 and 2.**

Drawing an object with EBL/VRM operation

- 1 Click on the [EBL/VRM] button on the drawing toolbar.**

The cursor changes to the EBL/VRM reference point cursor. (Refer to "14.2.5 Creating an object in the EBL/VRM mode").
- 2 Click on the position of the reference point of the EBL/VRM marker.**

The EBL/VRM marker is displayed.
- 3 Place the EBL/VRM marker on the starting point position and click the button.**

A starting point is created on the position on which the button was clicked and the property information is reflected in the object property dialog box. (Refer to "14.2.8 Object property dialog box").

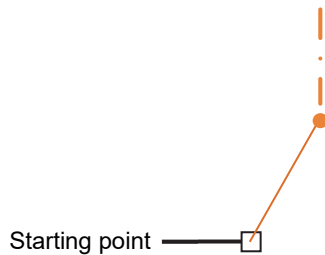

- 4 Place the EBL/VRM marker on the ending point position and click the button.**

An ending point is created on the position on which the button was clicked and the property information is reflected in the object property dialog box. (Refer to "14.2.8 Object property dialog box").

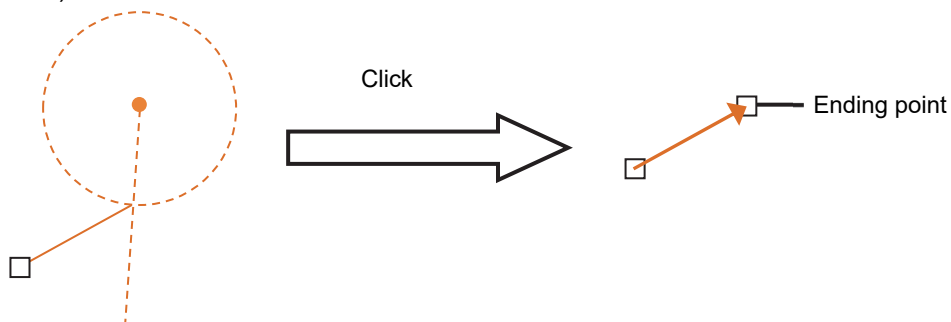

- 5 To create an object on another position continuously, repeat Steps 2 to 4.**

14.5.8.3 Tidal Stream mark

A current drift and a bearing can be input for a tidal stream mark. Edit the current drift (Drift) and the bearing (Set) after creating a tidal stream mark on the object property dialog box.

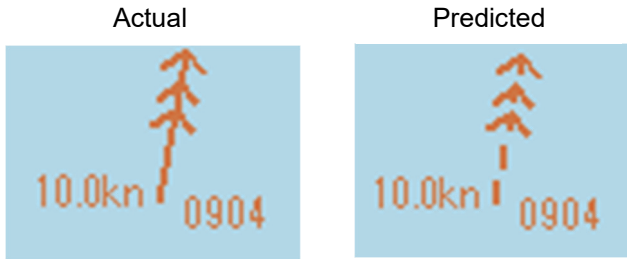

1 Click on the [Type] button on the drawing toolbar.

An icon list is opened.

Select the icon of a tidal stream mark. (Refer to "14.2.3 Selecting an object type").

2 Click on the position on which a tidal drift mark is to be created with the cursor.



A tidal stream mark is displayed on the position on which the button was clicked and the parameters of the tidal channel mark that was created are displayed on the object property dialog box.



Property ✕

Type: Tidal Stream

Position

Set/Drift/Time

Actual Predicted

Set °

Drift kn

Time (UTC)

▼ Comment

AAAAAAAAAAAAAAAA

▶ Display Scale

Latitude and longitude of the starting point

Select Actual/Predicted.

Specify a bearing.

Specify a current drift.

Specify date/time.

3 Adjust the parameters on the object property dialog box.

- **Specifying a bearing:** Display a numeric value input keyboard by clicking on the [Set] input box and enter a bearing (0 to 359°).
- **Specifying a current drift:** Display a numeric value input keyboard by clicking on the [Drift] input box and enter a current drift (0 to 99.9).
- **Selecting Actual/Predicted:** Select the check box of either Actual or Predicted. When Actual is selected, a tidal stream mark of a solid line is displayed. When Predicted is selected, a tidal mark of a broken line is displayed.
- **Specifying date/time:** Display a calendar + time picker by clicking on the calendar button and enter a date and a time in the [Time(UTC)] input box.

For the method of using a numeric value input keyboard, refer to "3.17.2 Name and function of each section of the keyboard" and for the method of using a calendar + time picker, refer to "3.17 Setting a Date and a Time [Calendar Operation)".

4 To create an object on another position continuously, repeat Steps 2 and 3.

Moving a tidal stream mark

1 Click the right mouse button on the tidal stream mark that is set.

The menu is displayed.

2 Click on [Move this object].

3 Click on the required destination position.

Creating an object by specifying the latitude and longitude

1 Click on the [Enter POSN] button on the drawing toolbar.

The [Enter Position] dialog box appears (Refer to "14.2.6 Creating an object by specifying latitude and longitude").

2 Enter the latitude and longitude of the position on which an object is to be created and click on the [Enter] button.

An object is created on the position of the specified latitude and longitude and the property information is reflected in the object property dialog box. (Refer to "14.2.8 Object property dialog box").

3 Adjust the parameters on the object property dialog box.

4 To create an object on another position continuously, repeat Steps 2 and 3.

Creating an object with EBL/VRM operation

- 1 Click on the [EBL/VRM] button on the drawing toolbar.**
The cursor changes to the EBL/VRM reference point cursor. (Refer to "14.2.5 Creating an object in the EBL/VRM mode").
- 2 Click on the position of the reference point of the EBL/VRM marker.**
The EBL/VRM marker is displayed.
- 3 Place the EBL/VRM marker on the position on which an object is to be created and click the button.**
An object is created on the position on which the button was clicked and the property information reflected in the object property dialog box. (Refer to "14.2.8 Object property dialog box").
- 4 Adjust the parameters on the object property dialog box.**
- 5 To create an object on another position continuously, repeat Steps 2 to 4.**

14.5.8.4 Highlighted display

Highlighted display can be set by creating an area of a polygon on a chart. Use highlighted display for attaching a comment on the chart or so on.

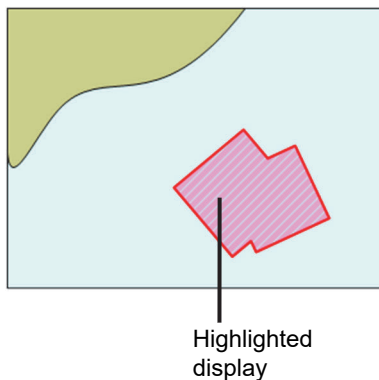

- 1 Click on the [Type] button on the drawing toolbar.**
An icon list is opened.
Select an icon of highlighted display. (Refer to "14.2.3 Selecting an object type").

2 Click on the position of a starting point with the cursor.

A starting point is created and the property information of vertex 1 is displayed on the object property dialog box.

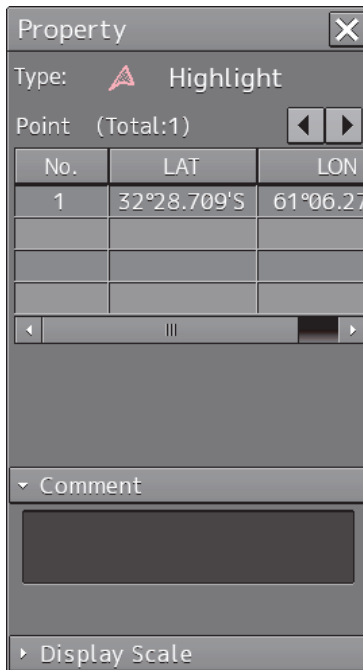

The latitude and longitude of the starting point (vertex 1) is displayed.

3 Move the cursor to the next vertex.

The latitude and longitude of the cursor are displayed near the cursor.



4 Click on the position on which the 2nd vertex is to be created.

A vertex is created and the latitude and longitude of the 2nd vertex are displayed on the object property dialog box.

The diagram illustrates the process of creating a two-vertex object. It shows a starting point (a white square) and a second vertex (a black square) connected by an orange line. A crosshair labeled 'Mark' is positioned at the second vertex. Below the starting point is the text 'Resetting the selection of the starting point'. Below the second vertex is the text 'Add the 2nd vertex'. To the right is a 'Property' dialog box with the following content:

Property [X]

Type: Highlight

Point (Total:2) [Left Arrow] [Right Arrow]

No.	LAT	LON
1	32°28.709'S	61°06.27
2	32°26.916'S	61°06.02

Comment

Display Scale

Annotations: 'The number of vertices becomes 2.' points to the 'Point (Total:2)' field. 'The coordinates of the 2nd vertex are entered.' points to the second row of the table.

5 Click on the position on which the 3rd vertex is to be created.

A triangle is created by connecting three vertices. The preview screen is displayed, enabling to check the object fill status.

The diagram shows a map with a green landmass and a blue sea. A triangle is formed by three vertices, with the area inside filled with a light orange color. A crosshair is positioned at the third vertex. An arrow points from the text 'The preview of the result of filling the object is displayed.' to the filled triangle.

The latitude and longitude of the 3rd vertex are displayed on the object property dialog box.

Property ✕

Type:  Highlight

Point (Total:3) ◀ ▶

No.	LAT	LON
1	32°28.709'S	61°06.27
2	32°26.916'S	61°06.02
3	32°27.149'S	61°04.0

Comment

Display Scale

The number of vertices becomes 3.

The coordinates of the 3rd vertex are entered.

- 6 To add another vertex continuously, click on the position on which the vertex is to be created.**

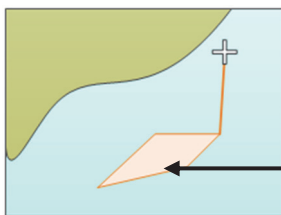

When the 4th vertex is determined, the preview display is updated.

When not adding another vertex, determine the object by double-clicking or clicking the right button on the object.

- 7 Adjust the parameters on the object property dialog box.**
- 8 To create an object on another position continuously, click on the [New] button in the [Enter Position] dialog and repeat Steps from 2 to 7.**

Creating a vertex by entering the position

- 1 Click on the [Enter POSN] button on the drawing toolbar.**

The [Enter Position] dialog box appears.
- 2 Enter the values of latitude and longitude of the vertex of the object in the [Position] box and click on the [Enter] button.**

The position of one vertex of the object is determined.
The [Bearing] box and the [Distance] box are enabled.
- 3 Enter the values of latitude and longitude of the next vertex of the object in the [Position] box. Alternatively, enter the bearing from the vertex that was determined immediately previously in the [Bearing] box and the [Distance] input box.**
- 4 Click on the [Enter] button.**
- 5 Determine the positions of 3 or more vertices by repeating Steps 2 to 4.**
- 6 Adjust the parameters on the object property dialog box.**
- 7 To create an object on another position continuously, repeat Steps 2 to 6.**

Creating an object with EBL/VRM operation

- 1 Click on the [EBL/VRM] button on the drawing toolbar.**

The cursor changes to the EBL/VRM reference point cursor. (Refer to "14.2.5 Creating an object in the EBL/VRM mode").
- 2 Click on the position of the reference point of the EBL/VRM marker.**

The EBL/VRM marker is displayed.
- 3 Placing the EBL/VRM marker on the position of the starting point and click the button.**

A vertex is created on the position on which the button was clicked, and the property information is displayed on the object property dialog box. (Refer to "14.2.8 Object property dialog box").

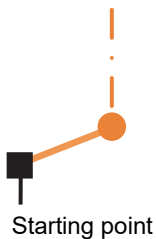

4 Click on the reference point.

The EBL/VRM marker is displayed to determine the 2nd vertex.

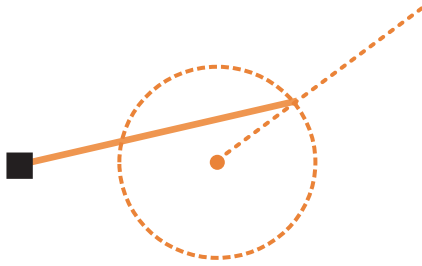

5 Place the EBL/VRM marker on the position of the 2nd vertex and click the button.

A vertex is created on the position on which the button was clicked and the property information is reflected in the object property dialog box. (Refer to "14.2.8 Object property dialog box".)

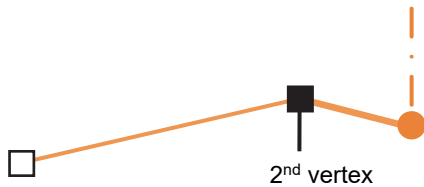

The EBL/VRM marker is reset to the EBL/VRM reference point cursor.

6 Place the EBL/VRM marker on the position of the 3rd vertex and click the button.

A triangle is created by connecting the three vertices. A preview screen is displayed, enabling the checking of the fill status of the polygon and Alerts area.

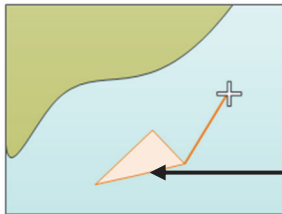

The preview of the result of filling the area is displayed.

7 Adjust the parameters on the object property dialog box.

8 To create an object on another position continuously, repeat Steps 1 to 7.

14.6 Collective Deletion of Objects [Delete by Type/Color]

Objects of the same shape and color can be deleted collectively by "Delete by Type/Colour".

- 1 Click on the [Menu] button on the left toolbar.**
The menu is displayed.
- 2 Click on the [User Chart] button on the menu.**
- 3 Click on the [Delete by Type/Colour] on the submenu.**
The [Delete by Type/Colour] dialog box appears.

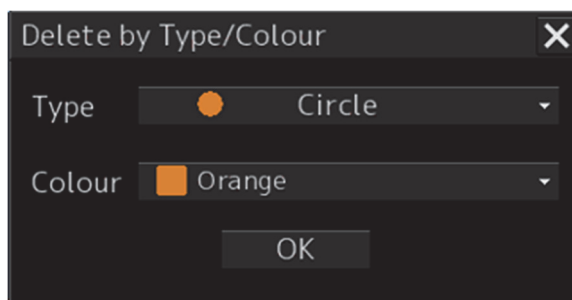

[Delete by Type/Colour] dialog box

- 4 Elect the common parameters for the objects to be deleted from the lists of the [Type] combo box and the [Colour] box.**
When [All] is selected, all the objects are deleted.
- 5 Click the [OK] button.**

Note

- If the color that is specified in the [Colour] box matches any of the point colour, line colour and area colour of the object, the object is targeted for deletion.

14.7 Managing/Editing Objects [Mark Line/List]

User charts and Mariner's Mark/Line objects can be managed/edited through [Mark/Line List].

14.7.1 Displaying the [Mark/Line List] dialog box

- 1 Click on the [Menu] button on the left toolbar.

The menu is displayed.

- 2 Click on the [User Chart] button on the menu.

- 3 Click on the [Mark/Line List] on the submenu.

The [Mark/Line List] dialog box appears.

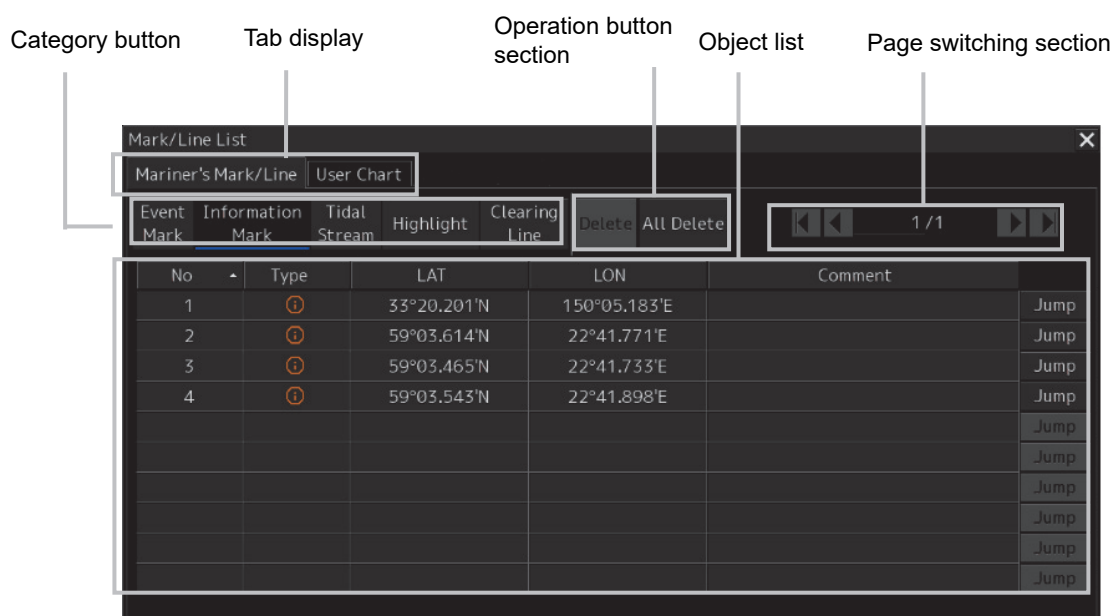

[Mark/Line List] dialog box (Display example of [User Chart] tab)

The tabs in the [Mark/Line List] dialog box consist of the following.

- **[User Chart] tab**
 - Symbol
 - Line
 - Area
 - Text
- **[Mariner's Mark/Line] tab (only the ECDIS screen and at creation of user chart only)**
 - Event Mark
 - Information Mark
 - Tidal Stream
 - Highlight (highlighted display)
 - Clearing Line(Refer to "14.7.3 Displaying a Mariner's Mark/Line List (ECDIS screen only)").

14.7.2 Displaying a user chart list

The [User Chart] tab displays a list of the user charts that are currently displayed.

The display of each category can be switched by clicking on the [Symbol] button/[Line] button/[Area] button/[Text] button.

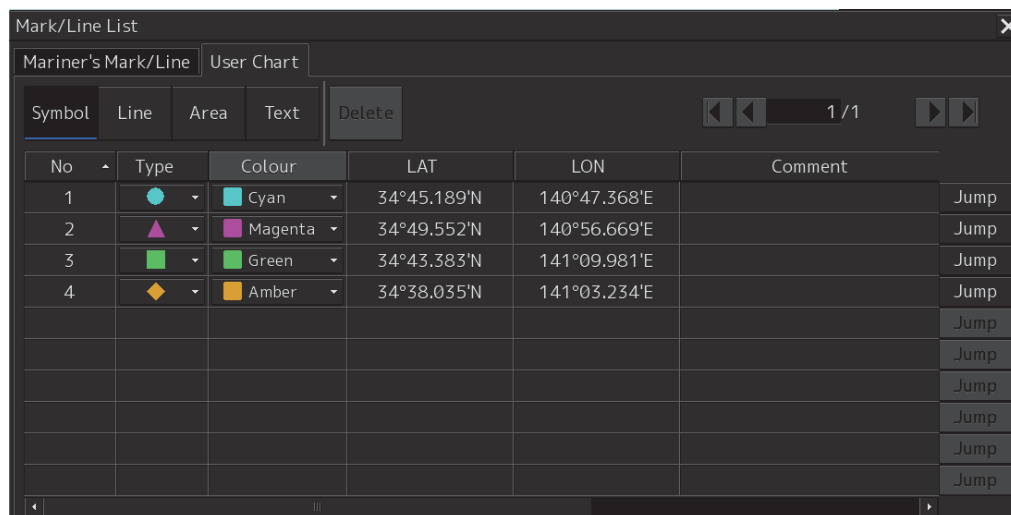

[User Chart] tab (example at selection of [Symbol])

14.7.2.1 Displaying an object on a chart

Click on the [Jump] button on the row of the object to be displayed on the chart.

14.7.2.2 Deleting an object

Select the row of the object to be deleted and click on the [Delete] button.

Note

As soon as the [Delete] button is clicked on, the object is deleted. Re-check whether the object can be deleted before clicking on the [Delete] button.

14.7.3 Displaying a Mariner's Mark/Line List (ECDIS screen only)

A Mariner's Mark/Line can be displayed by using the [Mariner's Mark/Line] tab.

Display of each category can be switched by clicking on the [Event Mark] button/[Information Mark] button/[Tidal Stream] button/[Highlight] button/[Clearing Line] button.

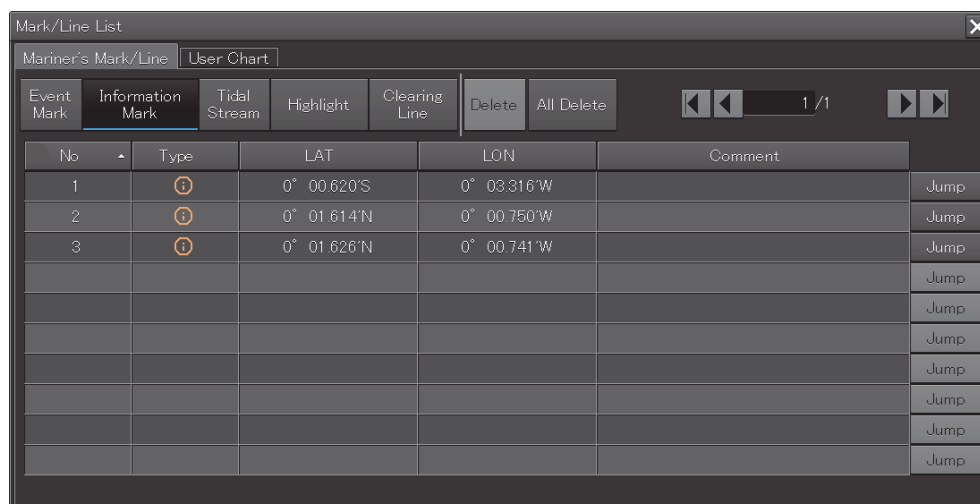

[Mariner's Mark/Line] tab (example at selection of [Information Mark])

14.7.3.1 Displaying an object on a chart

Click on the [Jump] button on the row of the object to be displayed on the chart.

14.7.3.2 Deleting an object

Select a line of the object to be deleted and click on the [Delete] button.

Note

As soon as the [Delete] button is clicked on, the object is deleted. Re-check whether the object can be deleted before clicking on the [Delete] button.

14.7.3.3 Deleting objects collectively from an object list

- 1 Click on the [All Delete] button.

A message dialog box for confirming deletion appears.

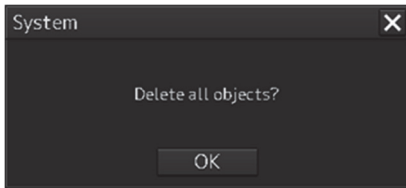

- 2 To execute deletion, click on the [OK] button. To cancel deletion, click on the [X] button.

14.8 Updating a Chart Manually (S-57/S-63/C-MAP)

Use the following procedure to update a chart.

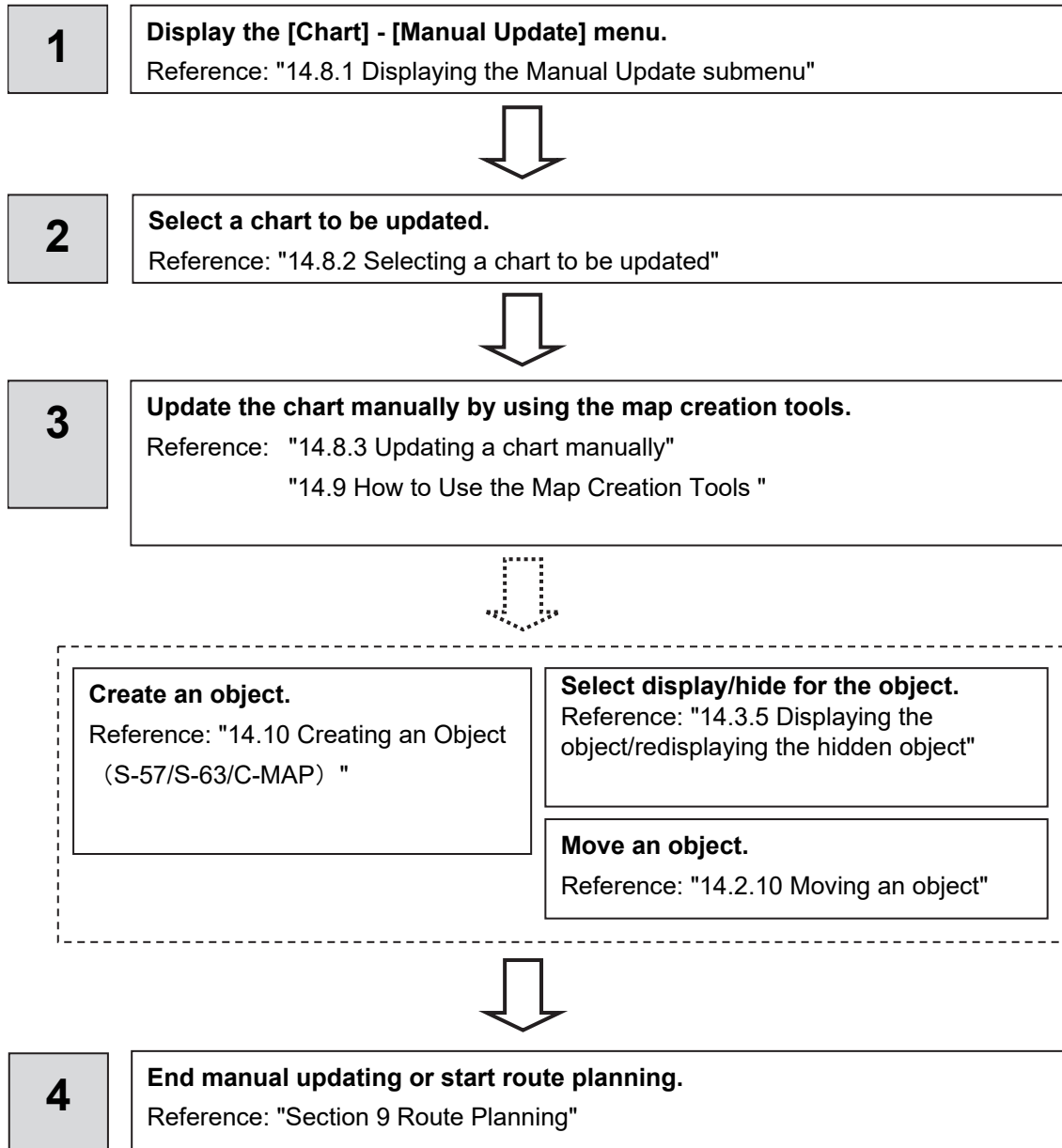

14.8.1 Displaying the Manual Update submenu

By selecting [Menu] - [Chart] - [Manual Update], the selected chart can be updated manually.

Restrictions

Multi-screen display is disabled at manual update of a chart. Even if multi-screen display is attempted prior to the commencement of manual update, the mode is switched to Single View if manual update is commenced.

Note:

- (1) In edit mode, the duration-dependent attribute is disabled temporarily. The objects that are hidden at the current time may be displayed.
- (2) Up to 100 objects can be edited from the start of editing to the saving of the editing by pressing the Save button.
- (3) Charts to be edited can be saved 50 times until they are updated.
- (4) When a chart to be edited is updated, all the manual updates up to then are hidden. The review is also disabled. The editing history can be checked by Update log of each chart.

Note:

- (1) While the manual update tool bar is active, the Chart Symbol setting is switched from "Simplified" to "Paper Chart" forcibly. When "Simplified" is selected before the Manual Update tool bar is displayed, the setting is reset to the original state after termination of the tool bar.
- (2) When the cursor is in AUTO mode, a manual update object can be edited only when the manual update tool bar is displayed and when the Manual Update tool bar is hidden, only the property screen display can be executed.

1. Click on the [Menu] button on the left toolbar.

The menu is displayed.

2. Click on the [Chart] button on the menu.

3. Click on the [Manual Update] button on the submenu.

The "Manual Update" toolbar is displayed.

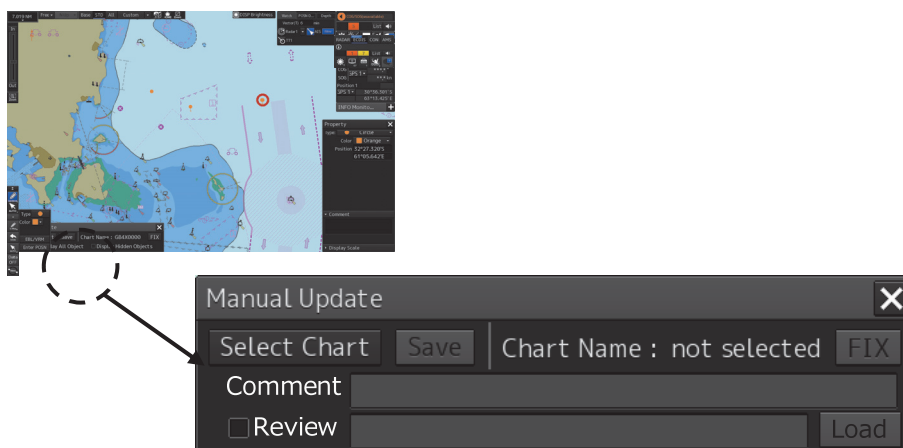

"Manual Update" toolbar

The following operations are available while the Manual Update tool bar is displayed.

Editing item	Operation
Manual update editing	Addition/editing of a manual update object
ENC object editing	Editing of the object on the chart
Attribute editing	Editing attributes
Remove function	Hiding an object (explicit save operation is necessary)
Delete function	Attaching a deletion symbol (explicit save operation is necessary)
Review function	Update history review function
Editing on the property screen	Editing on the property screen

Note:

For C-MAP, the Manual Update object is displayed only when only one check is ON in C-MAP

Ed 3 Database of [View-Option] - [Chart Common].

Otherwise, the Manual Update object is not displayed.

When multiple checks are ON for C-MAP Ed3 Database in [View-Option] - [Chart Common], clicking [Menu] - [Chart] - [Manual Update] opens the popup shown below and [Chart Common] dialog.

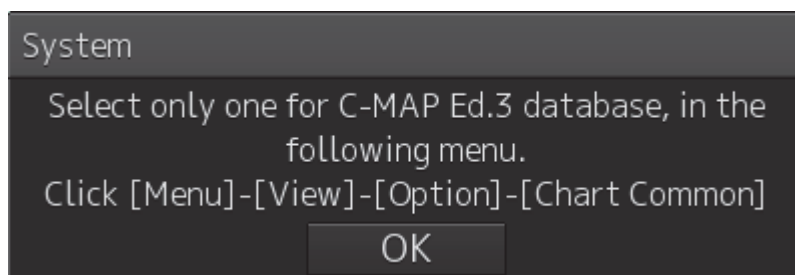

14.8.2 Selecting a chart to be updated

1. Click on the [Select Chart] button on the Manual Update toolbar.
The [Select Chart] dialog box appears.

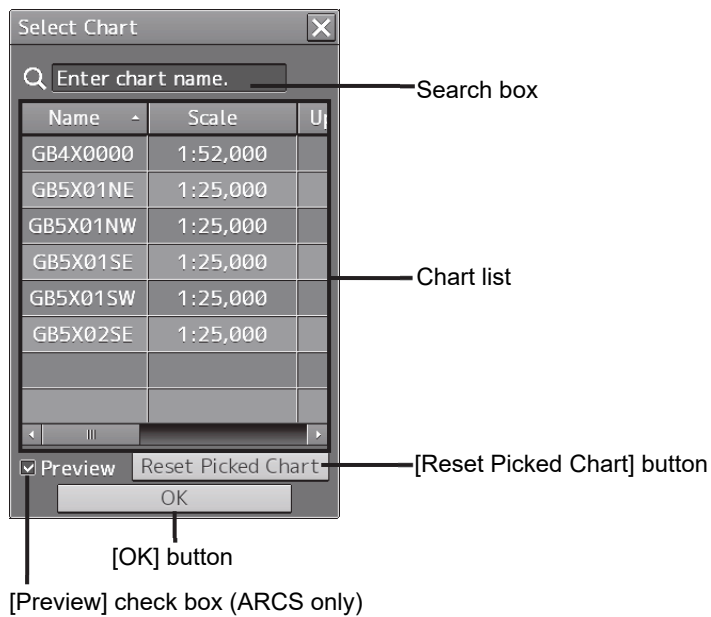

[Select Chart] dialog box

2. Select a chart file to be updated manually on the [Select Chart] dialog box.

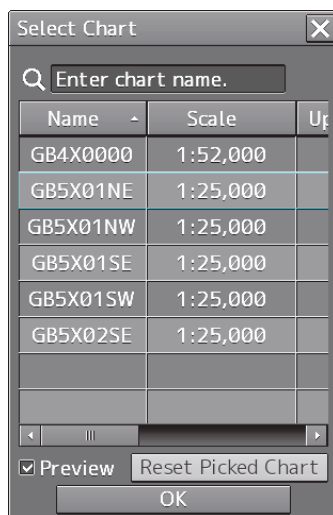

3. Click on the [OK] button in the [Select Chart] dialog box.
A chart is selected.

14.8.2.1 Displaying a chart list for the C-MAP chart

When a C-MAP chart is to be updated manually, the following charts are displayed in the chart list.

Only the databases of C-MAP Ed.3 Database that are selected in the [View-Options] dialog that is displayed by selecting [View]-[Options]-[Chart Common] in the menu are displayed in the list.

When no database is selected in the [View-Options] dialog that is displayed by selecting [View]-[Options]-[Chart Common] in the menu and a search condition is specified, all the C-MAP charts are displayed in the list.

When a chart is clicked on, only the chart that is displayed in View is displayed in the list.

14.8.2.2 Searching the position that is clicked on with the cursor

1. **Move the cursor to the position where manual update is to be performed and click the button.**

The chart that is drawn at the position that is selected by clicking is displayed in the chart list.

Memo

To clear the search result, click on the [Reset picked chart] (chart selection reset) button on the [Select Chart] dialog box. For C-MAP, all the charts in the database are displayed in the chart list.

14.8.2.3 Searching a chart with the chart name

1. Enter a chart name in the search box on the [Select Chart] dialog box.
The applicable chart is displayed.

Memo

To clear the search result, clear the input in the search box.

14.8.2.4 Absence/expiration of the C-MAP chart license

When C-MAP is targeted for manual update and the C-MAP that is selected from the chart list does not have any license or the license has expired, the chart is not selected and the following dialog is displayed.

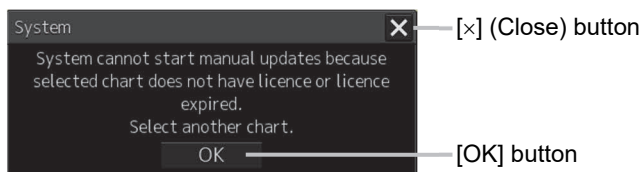

Close the dialog by clicking on the [OK] button or the [x] button and select another chart.

14.8.3 Updating a chart manually

1. Create/edit an object on the chart by using map creation tools.
(Refer to 14.9 How Use a Map Creation Tool (at Manual Update).)
2. Delete an object or change the properties as required.
(Refer to 14.10 Creating an Object.)
3. Click the [Save] button.
The manually updated object is saved in the chart.

14.8.4 Displaying selected chart only

1. Select a chart to be displayed according the procedure that is described in “12.8.2 Selecting a chart to be updated”.
2. Set the [FIX] (fixing the chart) on the Manual Update tool bar to ON.



Memo

For the C-MAP chart or the ARCS chart, the [FIX] button cannot be set to ON.

14.8.5 Entering an editor of the manual update

Memo

The editor of the manual update can be recorded.

When the entry is saved, the text that has been entered in the Comment column is recorded in the editing history.

Manual Update

Select Chart Save Chart Name : GB4X0000 FIX

Comment change ferry route

Review Load

Load Update Log

Select the update log for review.
The system can save 50 updates to the chart.

Save Time(UTC)	Comment
2017-03-09 02:33:31	change ferry rout

OK

Save the contents and display the editing history by clicking on the Load button.

14.9 How to Use the Map Creation Tools (at Manual Update of S-57/S-63/C-MAP)

At chart manual update also, use the same map creation tools in the same way as that of user chart creation. (Refer to "14.2 Using Map Creation Tools (User Chart Creation/Editing)".) However, there are the following differences in the map creation tools

- The user chart information bar is not displayed.
- The object that is saved cannot be deleted by the eraser tool (can be hidden).
- A Mariner's Mark/Line drawing object cannot be selected with the drawing tool.
- More icon types can be selected in the drawing tool.

When the chart is updated manually, "Update" is displayed on the Write tool button.

Note

At chart manual update, the bearing reference mode is fixed to [N UP] mode.

14.9.1 Deleting or hiding an object

1. Click on the eraser tool button.

The cursor changes to the eraser cursor.



2. Place the eraser cursor on the object and click the button.

At manual update, only pre-saved objects can be deleted by the eraser tool.

If the saved object is clicked on with the eraser tool, the object is hidden. All the property screens of the object that has been set to hide are displayed as disable and cannot be edited.

The object that is created and saved by manual update can be redisplayed unless deleted even if it is hidden.

If the chart that uses the hidden object is updated, the expiration date of the object is set (90 days from the date on which the object is c).

The object will be deleted after the expiration date.

For the details, refer to "14.10.12 Object Delete function" and "14.10.13 Object Remove function".

Operations in eraser tool mode

Mode	Target	Contents
Manual Update tool bar is displayed	Object that has been saved	Remove the object
	Object that has not been saved	Cancel the object addition (erase).
Manual Update tool bar is hidden	Object that has been saved	No operation

Note

The object that has been removed or deleted is excluded from the warning detection target.

14.9.2 Selecting an object type

1. Click on the [Type] button on the drawing toolbar.
An icon list dialog is displayed.
2. Select an object type by clicking on the icon on the icon list.
At manual update, the following icon list is displayed.

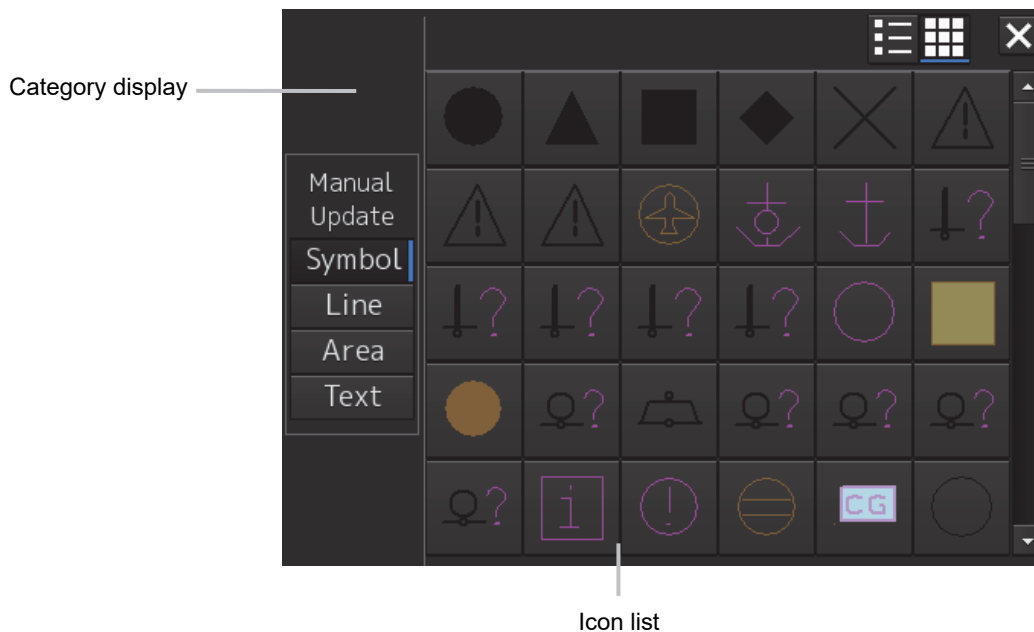

Icon list at manual update

The [Mariner's Mark/Line] button is not displayed on the icon list at manual update.

For the details of icons that can be selected from the icon list, refer to "Appendix C.6 Icon Button List for Manual Update (S-57)".

14.10 Creating an Object (S-57/S-63/C-MAP)

This section describes the procedures for changing the parameters of the object after creating the object on the user chart or chart during manual update.

Note

After automatic sailing, the mark/line may be shifted depending on how the cursor is placed on the target at the input.

To prevent the shift, place the cursor on the front edge of the target.

- Input method that does not cause shift (place the cursor on the front edge of the target)

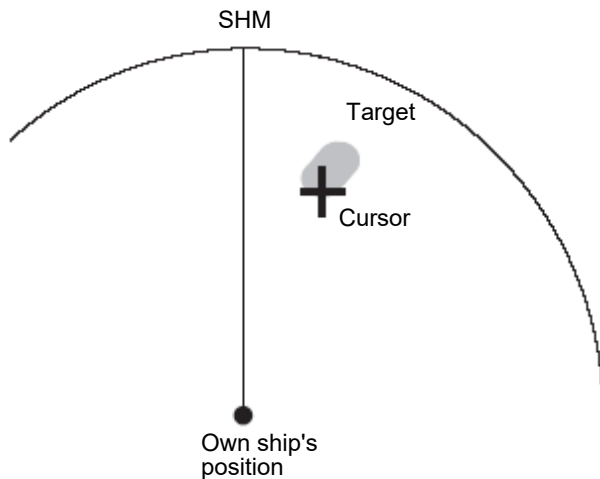

- Input method that causes shift (place the cursor on the center of the target)

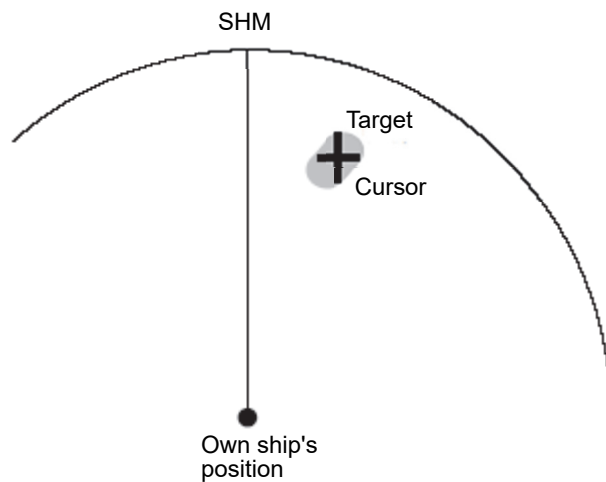

Note

Unlike the property screen at user chart editing, the manual update property screen does not have the Comment and Display Scale input columns.

14.10.1 Creating a symbol object (Symbol)

A symbol or Alerts symbol can be created by specifying the creation position with the cursor.

1. Click on the [Type] button on the drawing toolbar.

An icon list is opened.

Select a symbol or an icon of Alerts symbol. (Refer to "14.2.3 Selecting an object type".)

2. Click on the position on which the symbol is to be created with the cursor.



The symbol is displayed on the position on which the button is clicked and the parameters of the symbol that was created are displayed on the object property dialog box.

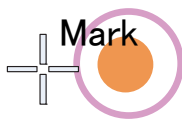

Latitude and longitude of the symbol creation position

Property

Type: Circle

Colour: Orange

Position: 34°50.465'N
141°04.937'E

Comment

Show comment

Display Scale

Non-ENC object

Property

Type: Airport/airfield

Position: 32° 33.135'S
60° 59.630'E

Edit Attribute

"Edit Attribute" button

ENC object

Note

For an ENC object, the screen can be switched to the attribute editing screen by using the [Edit Attribute] button.

For the details, refer to "14.10.9 Editing attributes of an object".

3. Adjust the parameters on the object property dialog box.
4. To create an object on another position continuously, repeat Steps 2 and 3.

14.10.1.1 Creating an object by specifying the latitude and longitude

1. Click on the [Enter POSN] button on the drawing toolbar.

The [Enter Position] dialog box appears (Refer to "14.2.6 Creating an object by specifying latitude and longitude).

2. Enter the latitude and longitude of the position on which an object is to be created and click on the [Enter] button.

An object is created on the specified latitude and longitude and the property information is reflected in the object property dialog box. (Refer to "14.2.8 Object property dialog box".)

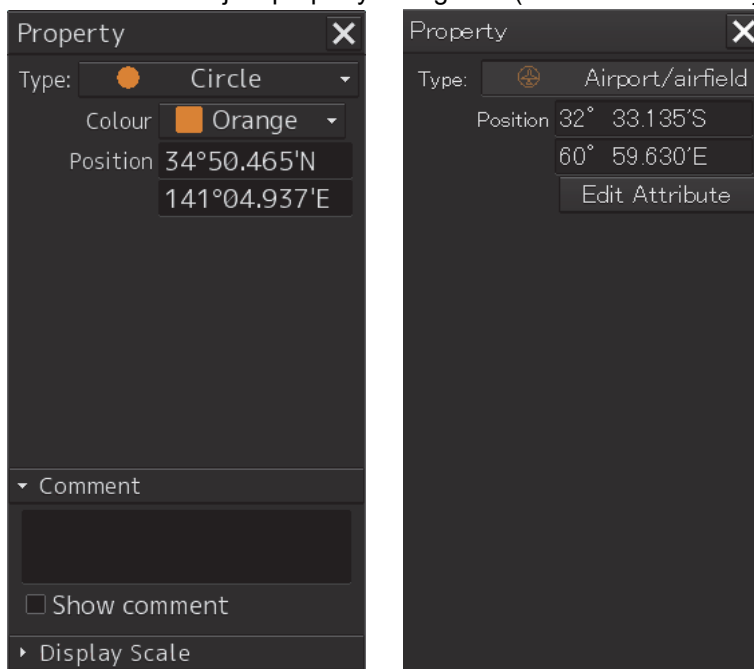

3. Adjust the parameters on the object property dialog box.
4. To create an object on another position continuously, repeat Steps 2 and 3.

14.10.1.2 Creating an object with EBL/VRM operation

1. Click on the [EBL/VRM] button on the drawing toolbar.

The cursor changes to the EBL/VRM reference point cursor. (Refer to "14.2.5 Creating an object in the EBL/VRM mode".)

2. Click on the position of the reference point of the EBL/VRM marker.

The EBL/VRM marker is displayed.

-
- 3. Place the EBL/VRM marker on the position on which the object is to be created and click the button.**

An object is created on the position on which the button was clicked and the property information is reflected in the object property dialog box. (Refer to "14.2.8 Object property dialog box".)

- 4. Adjust the parameters on the object property dialog box.**
- 5. To create an object on another position continuously, repeat Steps 2 to 4.**

14.10.2 Creating a simple line and Alerts line (Line object)

A simple line and Alerts line are created by using one vertex as an object. Alerts line is a line object that is detected as the warning target (danger line) of own ship.

Note

The color of Alerts line cannot be changed.

1. Click on the [Type] button on the drawing toolbar.

An icon list is opened.

Select an icon of a simple line or Alerts line. (Refer to "14.2.3 Selecting an object type".)

2. Click on the starting point with the cursor.

A vertex is created and the property information of the vertex is displayed on the object property dialog box.

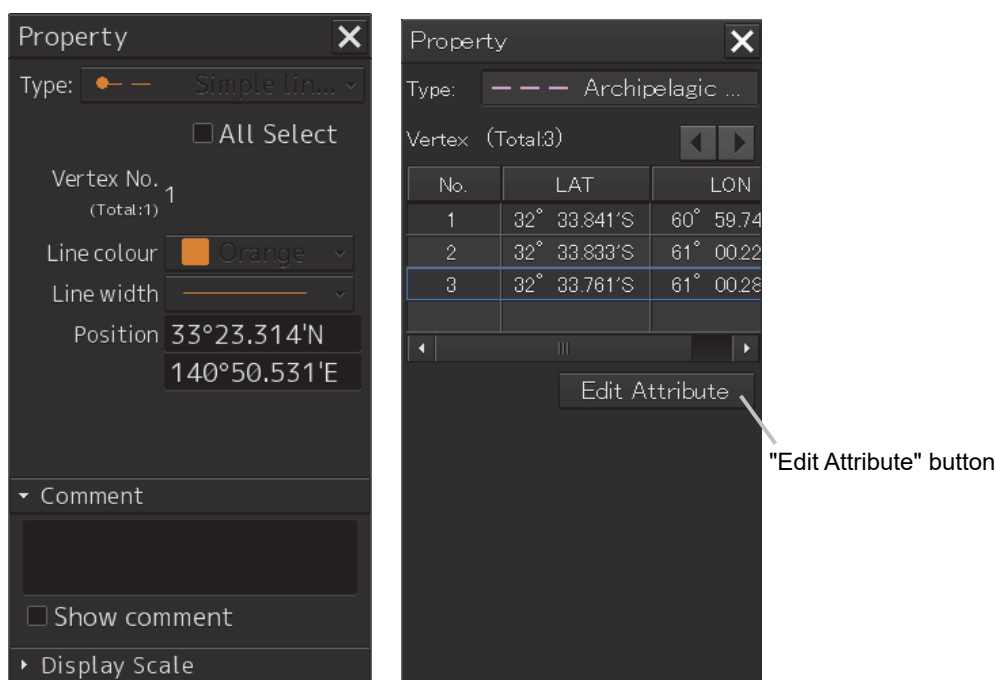

Note

For an ENC object, the screen can be switched to the attribute editing screen by using the [Edit Attribute] button.

For the details, refer to "14.10.9 Editing attributes of an object".

3. Move the cursor to the next vertex.

The latitude and longitude of the cursor are displayed near the cursor.



4. Click on the position on which the 2nd vertex is to be created.

A vertex is created and the parameters of the 2nd vertex are displayed on the object property dialog box.

Releasing the starting point selection state

Addition of 2nd point

Mark

The property screen is updated after the 2nd position is added.

Property

Type: Simple lin... [Type] becomes the medium point.

All Select

Vertex No. 2 (Total:2) The number of vertices becomes 2.

Line colour Orange Editing of the line colour and width is enabled.

Line width [dropdown]

Position 33°59.943'N 141°07.843'E The coordinates of the 2nd point are entered.

Comment

Show comment

Display Scale

5. Determine the line by double-click on the button or click the right button.

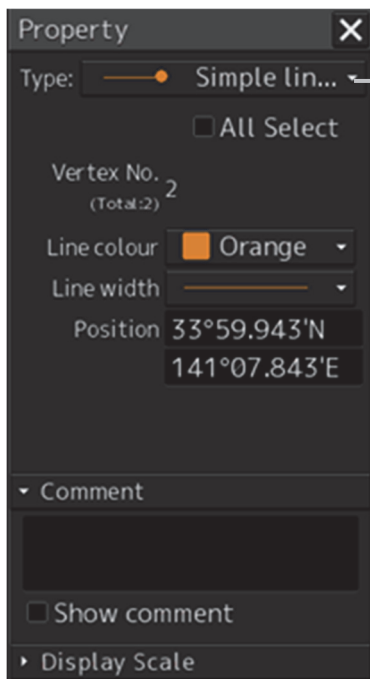
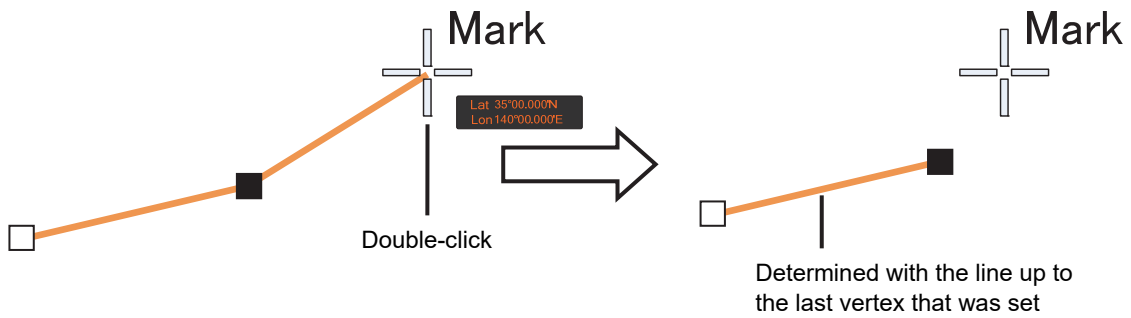

After determining of drawing, the last vertex changes to the end point.

6. Adjust the parameters on the object property dialog box.

7. To create an object on another position continuously, repeat Steps 2 to 6.

Memo

The property screen for the vertex that was created can be edited in AUTO mode. For the details of AUTO mode, refer to "3.14 Cursor AUTO Mode".

14.10.2.1 Creating a vertex by entering the position

- 1. Click on the [Enter POSN] button on the drawing toolbar.**
The [Enter Position] dialog box appears.
- 2. Enter the latitude and longitude of the vertex of the object in the [Position] box and click on the [Enter] button.**
The position of the vertex of the object is determined.
The [Bearing] box and the [Distance] box are enabled.
- 3. Enter the values of the latitude and the longitude of the next vertex in the [Position] box. Alternatively, enter the bearing from the vertex that was determined immediately previously in the [Bearing] box and the [Distance] input box.**
- 4. Click on the [Enter] button.**
- 5. Determine the positions of 3 or more vertices by repeating Steps 2 and 3.**
- 6. Adjust the parameters on the object property dialog box.**
- 7. To create an object in another position continuously, click on the [New] button of the [Enter Position] dialog and repeat Steps from 2 to 6.**

14.10.2.2 Creating an object with EBL/VRM operation

- 1. Click on the [EBL/VRM] button on the drawing toolbar.**
The cursor changes to the EBL/VRM reference point cursor. (Refer to "14.2.5 Creating an object in the EBL/VRM mode".)
- 2. Click on the position of the reference point of the EBL/VRM marker.**
The EBL/VRM marker is displayed.
- 3. Place the EBL/VRM marker on the starting point and click the button.**
A vertex is created on the position on which the button was clicked and the information is reflected in the object property dialog box. (Refer to "14.2.8 Object property dialog box".)

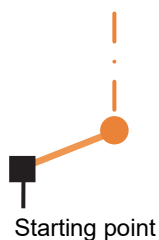

- 4. Click on the position of the reference point.**
The EBL/VRM marker that determines the 2nd point is displayed.

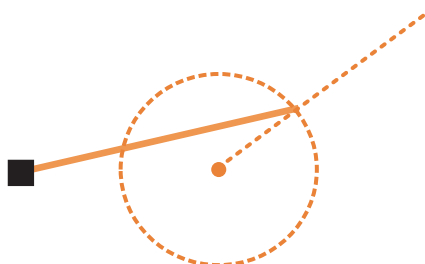

5. Place the EBL/VRM marker on the 2nd vertex and click the button.

A vertex is created on the position on which the button was clicked and the information is reflected in the object property dialog box. (Refer to "14.2.8 Object property dialog box".)

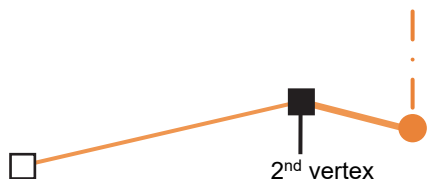

The EBL/VRM marker is reset to the EBL/VRM reference point cursor.

6. Adjust the parameters on the object property dialog box.

7. To create an object on another position continuously, repeat Steps 2 to 6.

14.10.3 Creating a circle, ellipse, and an arc (Line object)

A circle, an ellipse, and arc can be drawn with the cursor by specifying the center.

1. Click on the [Type] button on the drawing toolbar.

An icon list is opened.

2. Select an icon of a circle, an ellipse, or an arc.

(Refer to "14.2.3 Selecting an object type".)

3. Click on the position for the center with the cursor.

The center is created and the property information on the vertex is displayed on the object property dialog box.

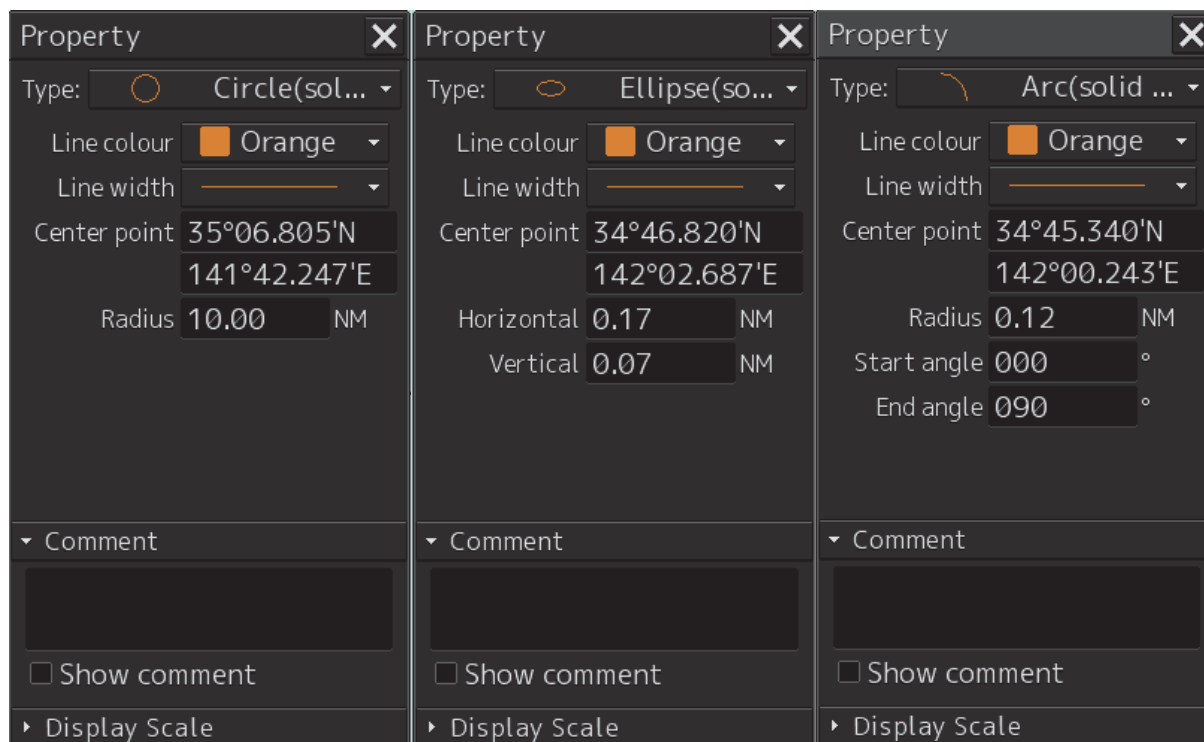

4. Draw a circle, an ellipse, or an arc.

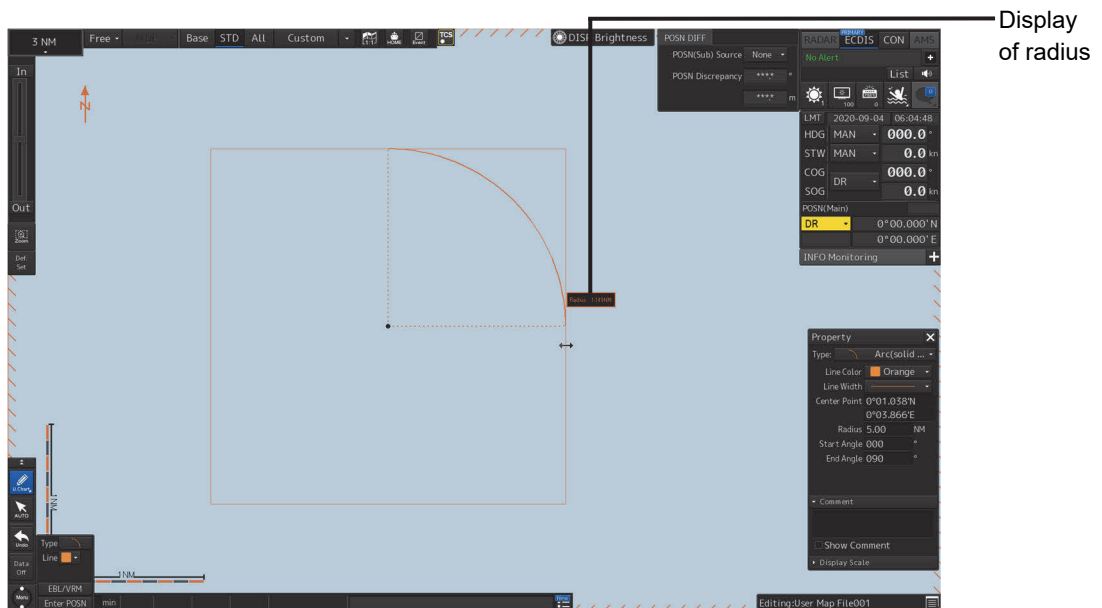
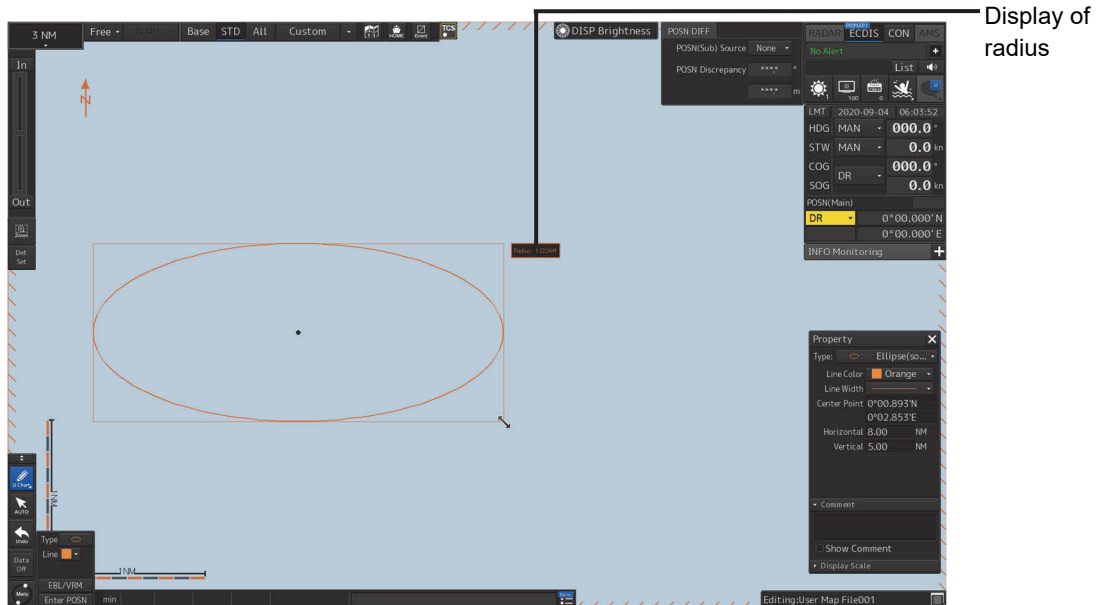
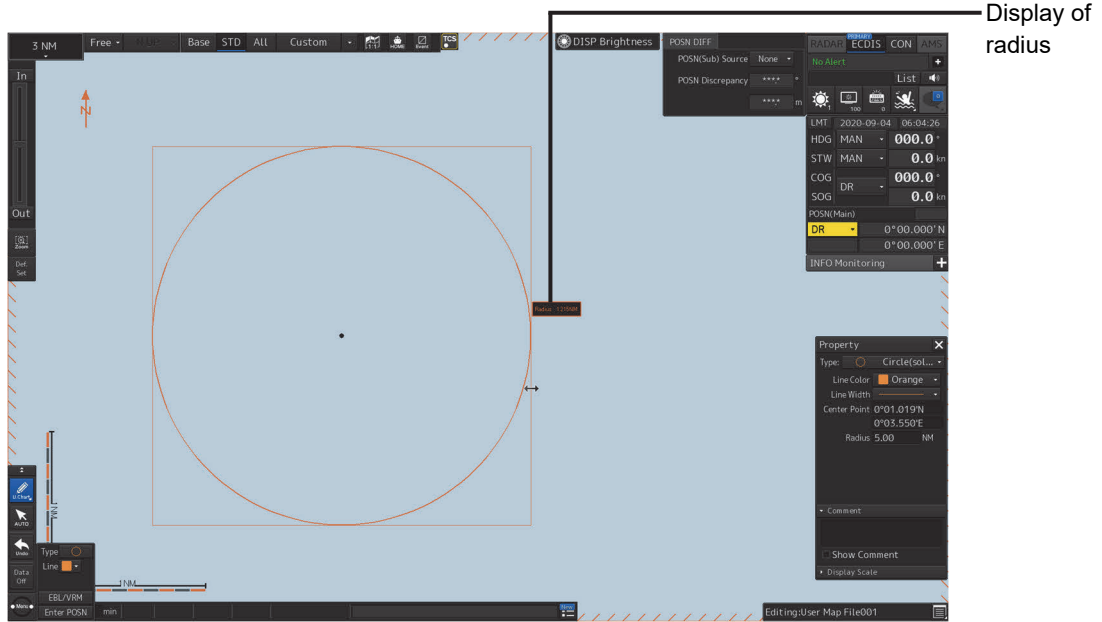

At creation of an arc, the starting angle and the ending angle of the arc to be created are the previous values or the initial values (starting angle: 0°, ending angle: 90°). To change the starting angle and the ending angle, change the values in [Start Angle] and [End Angle] on the object property dialog box.

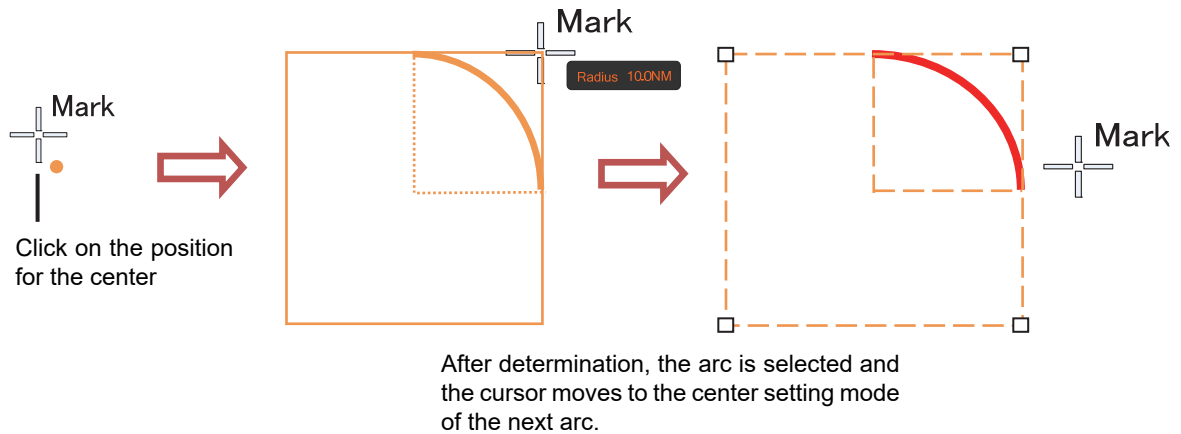

5. Determine the object by clicking the button again.
6. Adjust the parameters on the object property dialog box.
7. To create an object on another position continuously, repeat Steps 3 to 6.

14.10.3.1 Creating an object by specifying a position for the center and size of the object

1. Click on the [Enter POSN] button on the drawing toolbar.
The [Enter Position] dialog box appears. (Refer to "14.2.6 Creating an object by specifying latitude and longitude".)
2. Enter the coordinate of the center of the circle, ellipse, or arc and click on the [Enter] button of the [Enter Position] dialog box.
The center is created at the position of the specified coordinate and the property information is reflected in the object property dialog box. (Refer to "14.2.8 Object property dialog box".)
3. Set the parameters in the object property dialog box as indicated below.
 - Circle: Enter a value of [Radius].
 - Ellipse: Enter values of [Horizontal] and [Vertical].
 - Arc: Enter values of [Radius], [Start Angle], and [End Angle].
4. To create an object on another position continuously as required, repeat Steps 2 and 3.

14.10.4 Creating a polygon and Alerts area (Area object)

Create a polygon using all the vertices (3 or more) as one object. Alerts area is an area object that is detected as a warning target (danger area).

A polygon and Alerts area can be created in the same way as for simple line and Alerts line

1. Click on the [Type] button on the drawing toolbar.

An icon list is opened.

Select an icon of a polygon or Alerts area. (Refer to "14.2.3 Selecting an object type".)

2. Click on the starting point position with the cursor.

The starting point is created and the property information of vertex 1 is displayed on the object property dialog box.

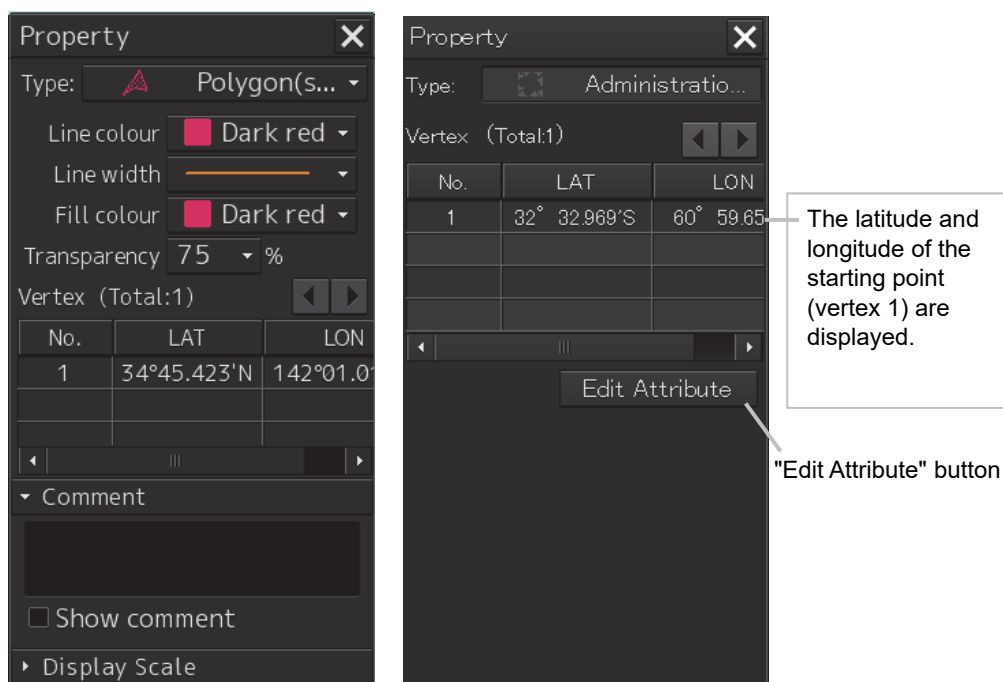

Note

For an ENC object, the screen can be switched to the attribute editing screen by using the [Edit Attribute] button.

For the details, refer to " 14.10.9 Editing attributes of an object".

3. Move the cursor to the next vertex.

The latitude and longitude of the cursor are displayed near the cursor.



4. Click on the position on which the 2nd vertex is to be created.

A vertex is created and the latitude and the longitude of the 2nd vertex are displayed on the object property dialog box

Resetting the starting point selection state

Add the 2nd point

Mark

Property

Type: Polygon(s...)

Line colour: Dark red

Line width: [Slider]

Fill colour: Dark red

Transparency: 75 %

Vertex (Total:2)

No.	LAT	LON
1	34°45.423'N	142°01.0'
2	34°45.612'N	142°01.3'

Editing of the line colour and width is enabled.

The number of vertices becomes 2.

The coordinates of the 2nd point are entered.

5. Click on the position on which the 3rd vertex is to be created.

A triangle is created by connecting the three vertices. A preview screen is displayed, enabling the checking of the fill statuses of the polygon and Alerts area.

The preview of the result of filling the area is displayed.

The latitude and longitude of the 3rd vertex are displayed on the object property dialog box.

Property

Type: Polygon(s...)

Line colour Dark red

Line width

Fill colour Dark red

Transparency 75 %

Vertex (Total:3)

No.	LAT	LC
1	34°45.423'N	142°01
2	34°45.612'N	142°01
3	34°45.984'N	142°01

Comment

Show comment

Display Scale

The editing of the line colour, line width, fill colour, and transparency is enabled.

The number of vertices becomes 3.

The coordinates of the 3rd vertex are entered.

- To add another vertex continuously, click on the position on which the vertex is to be created.

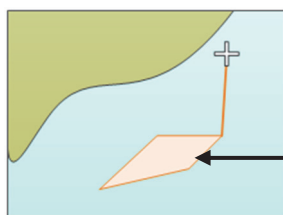

When the 4th vertex is determined, the preview display is updated.

When not adding any further vertices, determine the polygon or Alerts area by double-clicking the button or clicking the right button.

- Adjust the parameters on the object property dialog box.
- To create an object on another position continuously, repeat Steps 2 to 7.

14.10.4.1 Creating a vertex by entering the position

- Click on the [Enter POSN] button on the drawing toolbar.
The [Enter Position] dialog box appears.
- Enter the latitude and longitude of the vertex of the object in the [Position] box and click on the [Enter] button.
The position of one vertex of the object is determined.
The [Bearing] box and the [Distance] box are enabled.
- Enter the values of the latitude and the longitude of the next vertex in the [Position] box. Alternatively, enter the bearing from the vertex that was determined immediately previously in the [Bearing] box and the [Distance] input box.

4. Click on the [Enter] button.
5. Determine 3 or more vertices by repeating Steps 2 to 4.
6. Adjust the parameters on the object property dialog box.
7. To create an object on another position continuously, repeat Steps 2 to 6.

14.10.4.2 Creating an object with EBL/VRM operation

1. Click on the [EBL/VRM] button on the drawing toolbar.
The cursor changes to the EBL/VRM reference point cursor. (Refer to "14.2.5 Creating an object in the EBL/VRM mode".)
2. Click on the position of the reference point of the EBL/VRM marker.
The EBL/VRM marker is displayed.
3. Place the EBL/VRM marker on the starting position and click the mouse button.
A vertex is created on the position on which the button was clicked and the parameter information is reflected on the object property dialog box. (Refer to "14.2.8 Object property dialog box".)

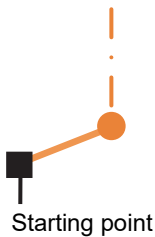

4. Click on the position of the reference point.
The EBL/VRM marker that determines the 2nd vertex is displayed.

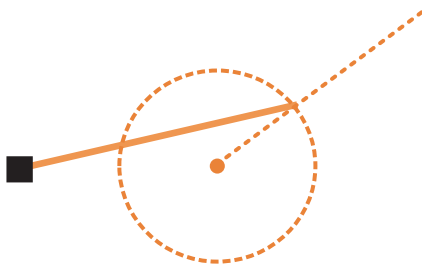

5. Place the EBL/VRM marker on the 2nd vertex position and click the button.
A vertex is created on the position on which the button was clicked and the property information is reflected in the object property dialog box. (Refer to "14.2.8 Object property dialog box".)

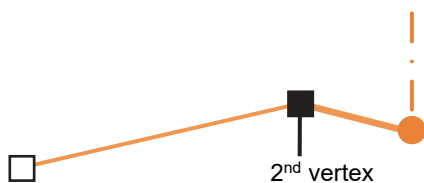

The EBL/VRM marker is reset to the EBL/VRM reference point cursor.

6. Place the EBL/VRM marker on the position of the 3rd vertex and click the button.

A triangle is created by connecting the three vertices. The preview screen is displayed, enabling the checking of the fill state of the polygon and Alerts area.

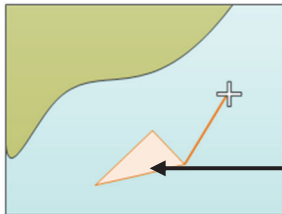

Preview of the area fill result is displayed.

7. Adjust the parameters on the object property dialog box.

8. To create an object on another position continuously, repeat Steps 1 to 7.

14.10.5 Creating circle, ellipse, and fan areas (Area object)

Circle, ellipse, and fan areas can be created in the same way as for creating a circle, an ellipse, or an arc of the Line object.

1. Click on the [Type] button on the drawing toolbar.

An icon list is opened.

2. Select an icon of circle, ellipse, or arc. (Refer to "14.2.3 Selecting an object type".)

3. Click on the position to be the center with the cursor.

A center is created and the vertex property information is displayed on the object property dialog box.

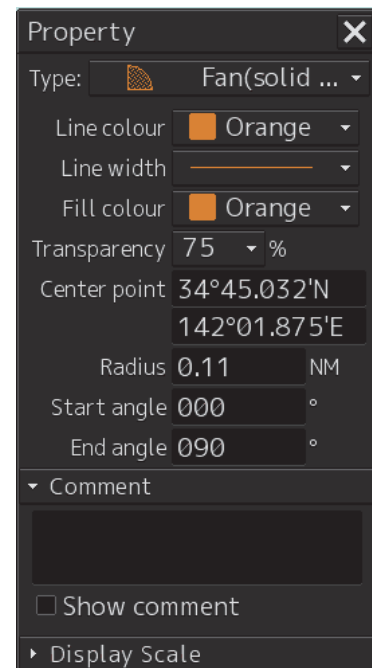
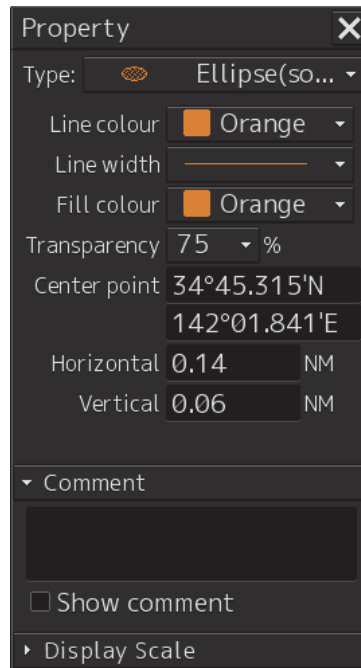
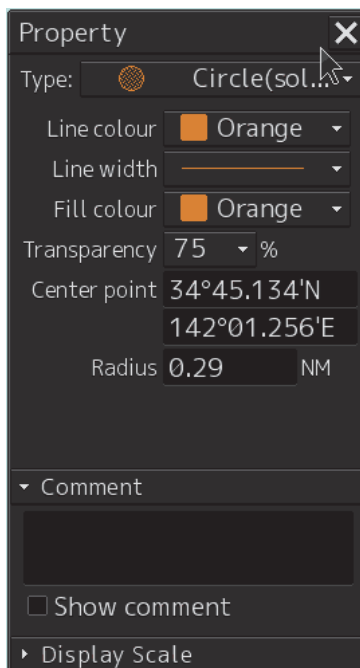

4. Draw a circle, an ellipse, and an arc.

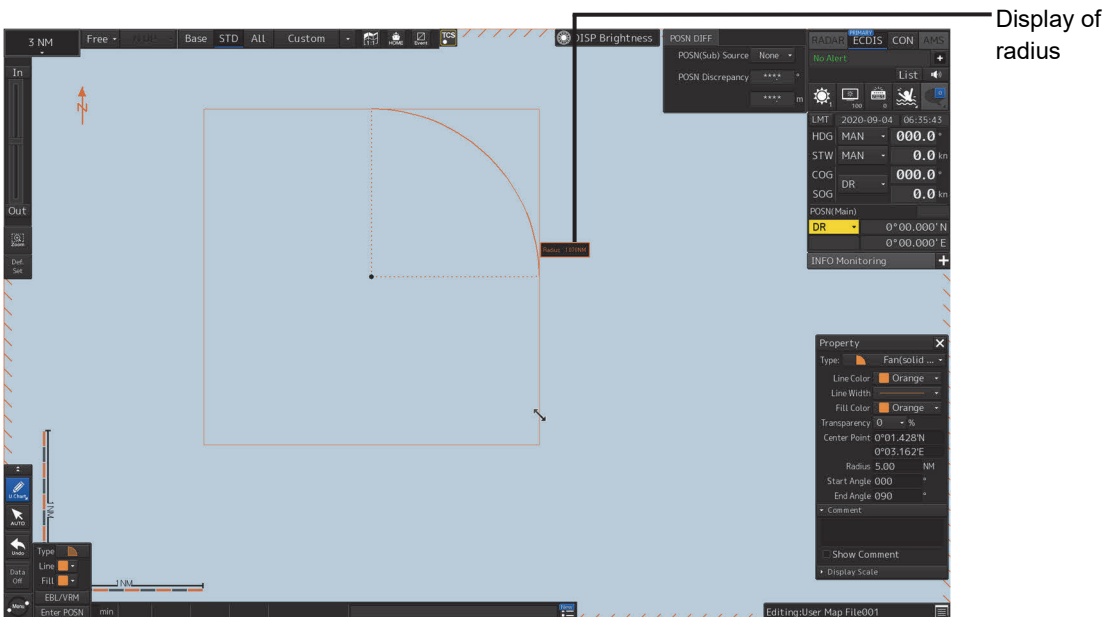
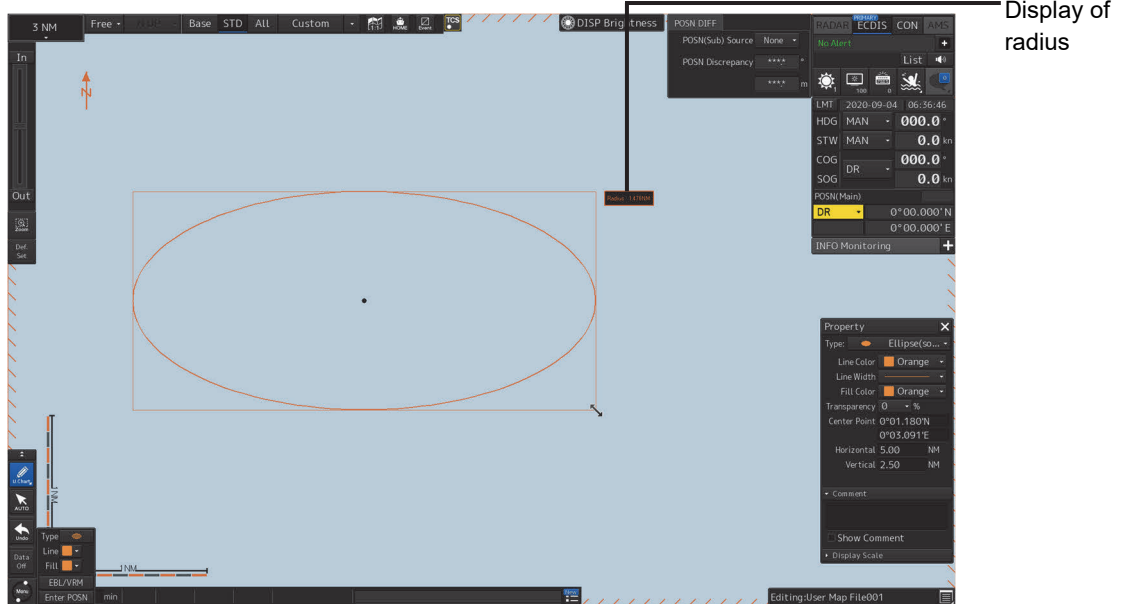
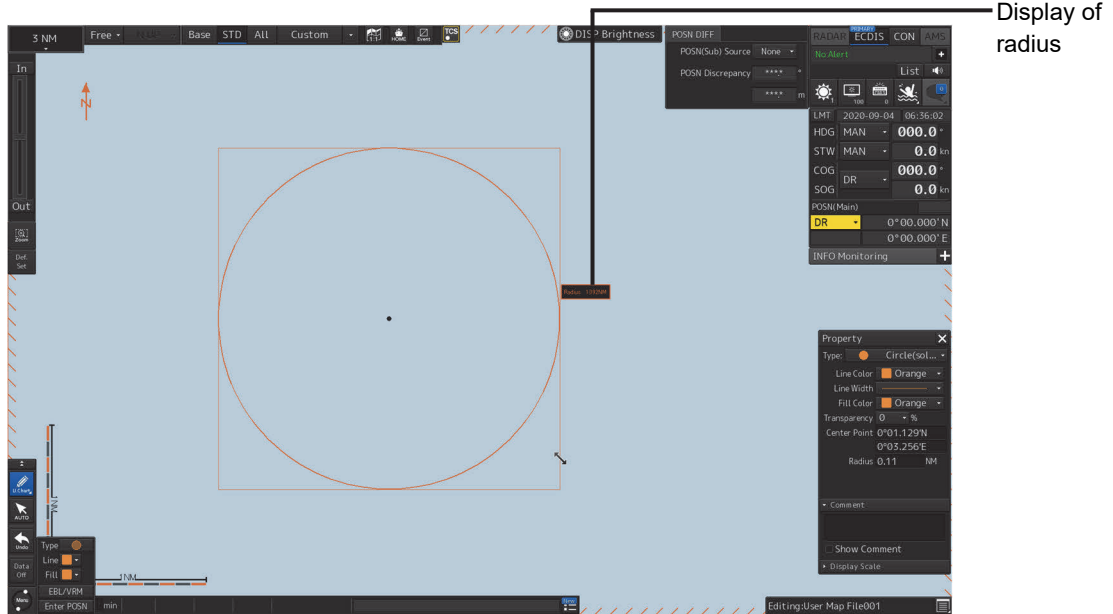

At creation of an arc, the starting angle and the ending angle of the arc to be created are the previous values or the initial values (starting angle: 0°, ending angle: 90°). To change the starting angle and the ending angle, change the values in [Start Angle] and [End Angle] on the object property dialog box.

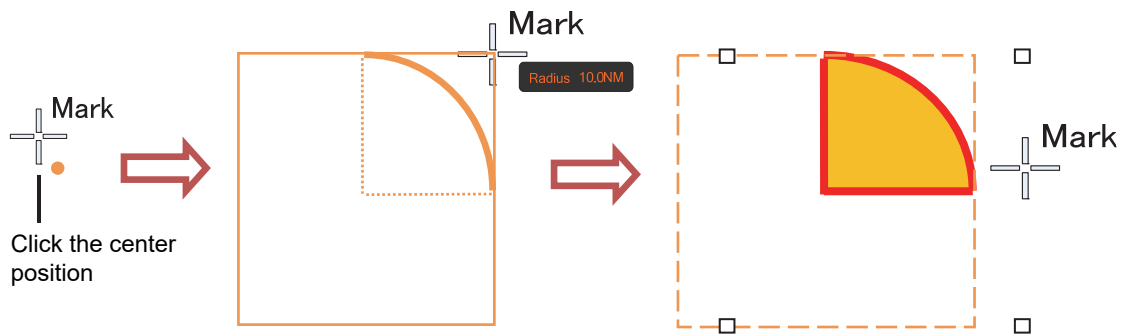

After determination, the arc is selected and the cursor moves to the center setting mode for the next arc.

5. Determine the object by clicking the button again.
6. Adjust the parameters on the object property dialog box.
7. To create an object on another position continuously, repeat Steps 3 to 6.

14.10.5.1 Creating an object by specifying the center position and the object size

1. Click on the [Enter POSN] button on the drawing toolbar.
The [Enter Position] dialog box appears (Refer to "14.2.6 Creating an object by specifying latitude and longitude".)
2. Enter the coordinates of the center of the circle, ellipse, or arc and click on the [Enter] button on the [Enter Position] dialog box.
A center point is created on the position of the specified coordinates and the property information is reflected in the object property dialog box (Refer to "14.2.8 Object property dialog box".)
3. Set the following parameters on the object property dialog box.
 - Circle: Enter a value of [Radius].
 - Ellipse: Enter values of [Horizontal] and [Vertical].
 - Arc: Enter values of [Radius], [Start Angle], and [End Angle].
4. To create an object on another position continuously as required, repeat Steps 2 and 3.

14.10.6 Creating a text (Text object)

Any character information can be displayed on the user chart.

1. Click on the [Type] button on the drawing toolbar.

An icon list is opened.

Select a text (Txt) icon. (Refer to "14.2.3 Selecting an object type".)

2. With the cursor, click on the position on which an object is to be created.



A text box is created at the position on which the button was clicked and a text is displayed.



The parameters of the text that was created are displayed on the object property dialog box.

Property

Type: Text

Colour Orange

Font size 16(Normal)

Position 34°44.382'N
142°01.639'E

Angle 090 °

Text
Text

Edit template...

Comment

Display Scale

Select a character colour from the list.

Select a character size from the list.

Enter the coordinates of the text display position.

Enter the angle from the 12 O'clock bearing when angling the text.

Enter a text (up to 64 characters).

To use a template, select a template from the list by clicking the button.

3. Adjust the parameters on the object property dialog box.

For the text input method, refer to "14.10.6.3 Editing a text", for the template usage method, refer to "14.10.6.4 Editing a template", and for the text angling method, refer to "14.10.6.5 Changing a text angle".

4. To create an object on another position continuously, repeat Steps 2 and 3.

14.10.6.1 Creating a text by specifying the latitude and longitude

1. Click on the [Enter POSN] button on the drawing toolbar.

The [Enter Position] dialog box appears (Refer to "14.2.6 Creating an object by specifying latitude and longitude".)

2. Enter the latitude and longitude of the object to be created and click on the [Enter] button.

An object is created on the specified latitude and longitude and the property information is reflected in the object property dialog box. (Refer to "14.2.8 Object property dialog box".)

3. Adjust the parameters on the object property dialog box.

For the text input method, refer to "14.5.6.3 Editing a text", for the template usage method, refer to "14.5.6.4 Editing a template", and for the text angling method, refer to "14.5.6.5 Changing a text angle".

4. To create an object on another position continuously, repeat steps 2 and 3.

14.10.6.2 Creating a text with EBL/VRM operation

1. Click on the [EBL/VRM] button on the drawing toolbar.

The cursor changes to the EBL/VRM reference point cursor. (Refer to "14.2.5 Creating an object in the EBL/VRM mode".)

2. Click on the position of the reference point position of the EBL/VRM marker.

The EBL/VRM marker is displayed.

3. Place the EBL/VRM marker on the position on which an object is to be created and click the button.

An object is created on the position on which the button was clicked and the property information is reflected in the object property dialog box. (Refer to "14.2.8 Object property dialog box".)

4. Adjust the parameters on the object property dialog box.

For the text input method, refer to "14.10.6.3 Editing a text", for the template usage method, refer to "14.10.6.4 Editing a template", and for the text angling method, refer to "14.10.6.5 Changing a text angle".

5. To create an object on another position continuously, repeat Steps 2 to 4.

14.10.6.3 Editing a text

1. Click on the [Text] input box

A character input full keyboard is displayed.

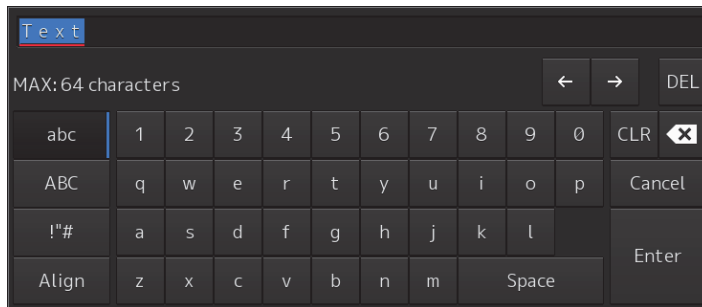

2. Create a text.

For the method of using the character input full keyboard, refer to "3.16.2 Name and function of each section of the keyboard".

3. Close the character input full keyboard by clicking on the [Enter] key.

4. To change a character color, select a required character color from the [Color] combo box.

5. To change a character size, select a required character size from the [Font size] combo box.

14.10.6.4 Editing a template

By registering a frequently used text as a template, the template can be used at text creation.

1. Click on the [Edit Template] button.

The [Template] dialog box appears.

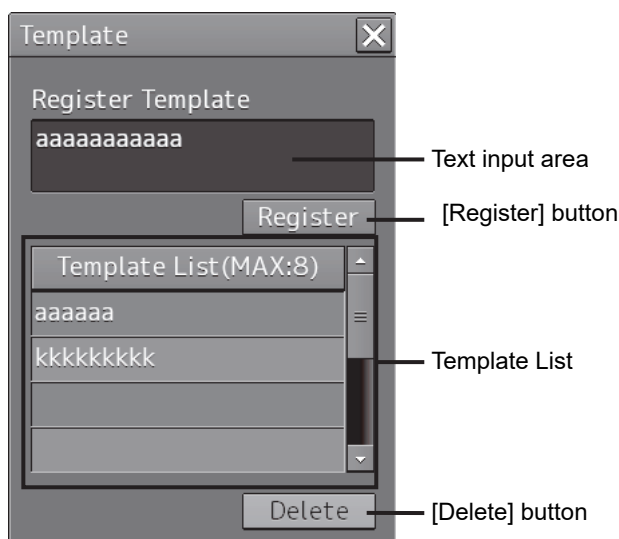

2. Click on a text input area.

A character input full keyboard is displayed.

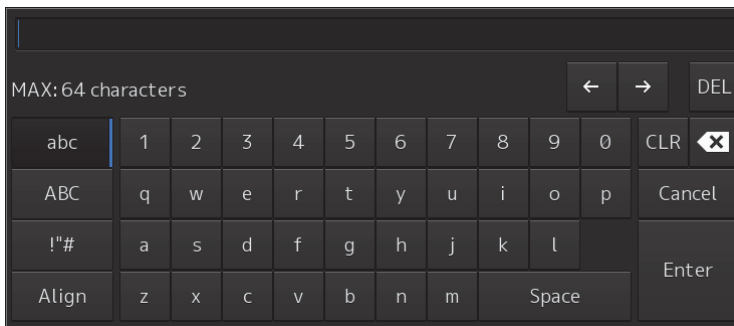

3. Create a text.

For the method of using the character input full keyboard, refer to "3.16.2 Name and function of each section of the keyboard".

4. Close the character input full keyboard by clicking on the [Enter] key.

5. Click on the [Register] button.

6. Close the [Template] dialog and click on [▼] on the right side of the text input area of the object properties dialog.

[Template List] is displayed.

7. Select any template.

8. To delete unnecessary templates, select the unnecessary templates in the [Template List] and click on the [Delete] button.

14.10.6.5 Changing a text angle

Under the factory setting, a text is oriented horizontally. The text can be angled or inverted according to the text creation position.

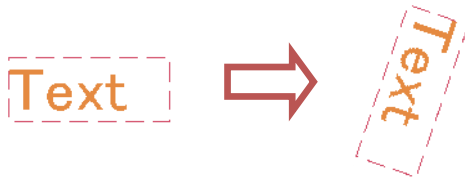

1. Click on the [Angle] input box.

A numeric value input keyboard is displayed.

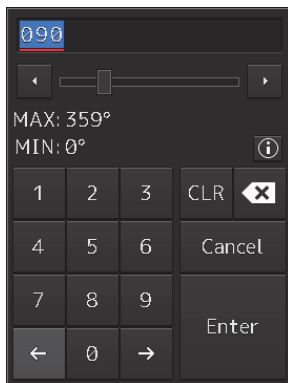

2. Enter an angle.

Specify an angle in clockwise based on the direction of the 12 O'clock as 0°. Under the factory setting, the angle is set to 90° (horizontal).

For the method of using the numeric value input keyboard, refer to "3.17.2 Name and function of each section of the keyboard".

14.10.7 Creating an arrow (Line object)

An arrow can be displayed on the user chart or chart.

1. Click on the [Type] button on the drawing toolbar.

An icon list is displayed.

2. Select the arrow icon. (Refer to "14.2.3 Selecting an object type".)

3. Click on the starting position with the cursor.

A starting point is created and the property information of the starting point is displayed on the object property dialog box.

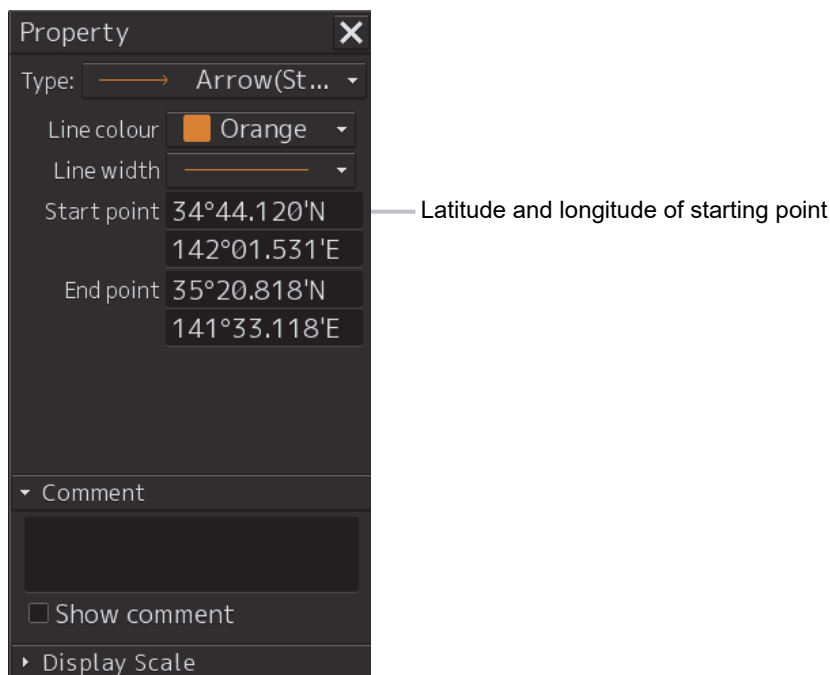
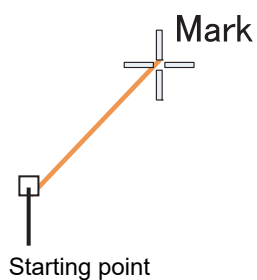

Note

The colour, line type, and line width of a starting point cannot be changed.

4. Click on the position of the ending point with the cursor.

An ending point is created and the property information of the ending point is displayed on the object property dialog box.

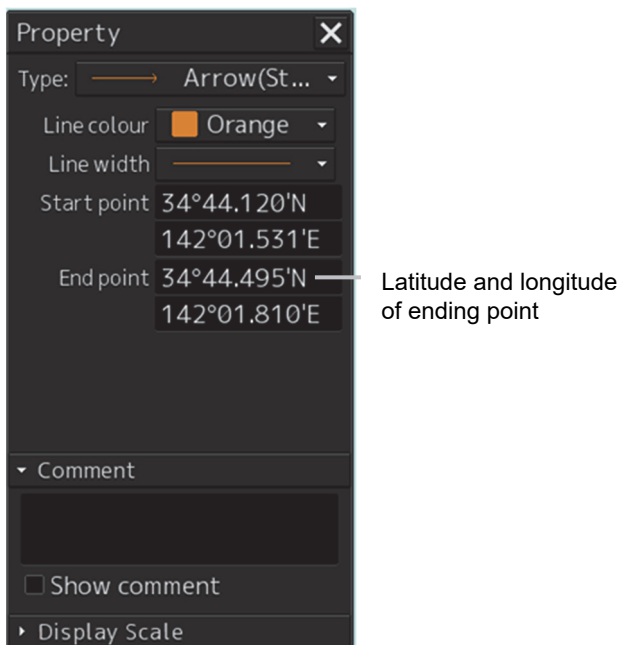
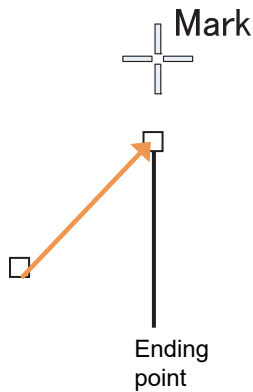

5. Adjust the parameters on the object property dialog box.

6. To create an object on another position continuously, repeat Steps to 3 to 5.

14.10.7.1 Creating an object by specifying the starting point/ending point position coordinates

1. Click on the [Enter POSN] button on the drawing toolbar.

The [Enter Position] dialog box appears (Refer to "14.2.6 Creating an object by specifying latitude and longitude".)

2. Enter the coordinates of the starting point and click on the [Enter] button.

A starting point of the arrow is created on the position of the specified coordinates and the property information is reflected in the object property dialog box. (Refer to "14.2.8 Object property dialog box".)

3. Enter the coordinates of the ending point and click on the [Enter] button.

An ending point of the arrow is created on the position of the specified coordinates and the property information is reflected in the object property dialog box.

4. To create an object on another position continuously, repeat Steps 1 to 3.

14.10.7.2 Drawing an object with EBL/VRM operation

1. Click on the [EBL/VRM] button on the drawing toolbar.

The cursor changes to the EBL/VRM reference point cursor. (Refer to "14.2.5 Creating an object in the EBL/VRM mode".)

2. Click on the position of the reference point of the EBL/VRM marker.

The EBL/VRM marker is displayed.

3. Place the EBL/VRM marker on the position of the starting point and click the button.

4. Click on the reference position of the EBL/VRM marker.

A starting point is created on the position on which the button was clicked and the property information is displayed on the object property dialog box. (Refer to "14.2.8 Object property dialog box".)

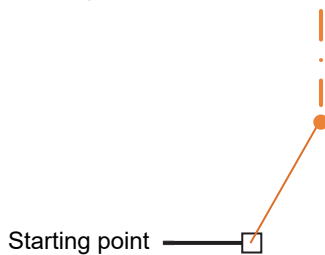

5. Place the EBL/VRM marker on the position of the ending point and click the button.

An ending point is created on the position on which the button was clicked and the property information is displayed on the object property dialog box. (Refer to "14.2.8 Object property dialog box".)

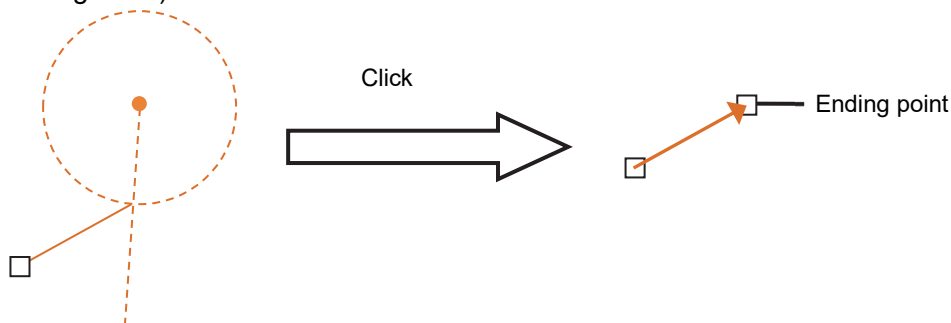

6. To create an object on another position continuously, repeat Steps 2 to 5.

14.10.8 Property of a Sounding object

Only a Sounding object has the Property screen different from other objects, enabling input of a Sounding value.

Property ✕

Type: Sounding

Position 32° 33.074'S
61° 00.254'E

Edit Attribute

Sounding 0.0

Sounding value input box

Note

In the case of C-MAP, you can not enter the sounding value.

14.10.9 Editing attributes of an object

The attribute input rules of the ENC object that is handled by manual update are specified in “S-57 Appendix A Chapter 2 – Attributes”. The following six types of ENC object attributes are available.

Attribute type	
enumerated('E')	One of the options can be selected.
list('L')	Although the attribute is the same as enumerated, multiple options can be selected.
float('F')	A decimal digit can be input.
integer('I')	An integer can be input.
coded string('A')	Free text
free text('S')	Free text

To display an object correctly at manual update, the attributes must be input as described in “S-57 Appendix A Chapter 2 – Attributes”.

For types 'E', 'L', 'F', and 'I', options and input ranges are displayed in the input dialog. For types 'A' and 'S', enter values according to the rules by referencing “C.6.5 Attributes of an ENC object”.

14.10.9.1 Type E

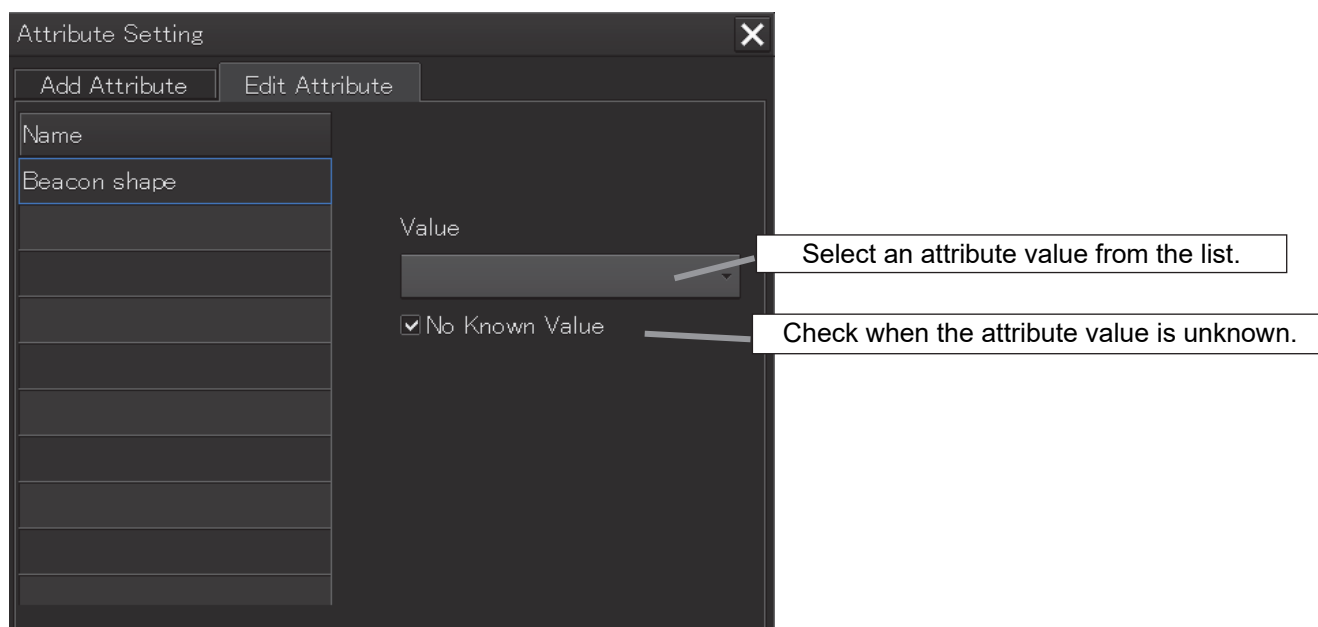

14.10.9.2 Type L

The screenshot shows the 'Attribute Setting' dialog with the 'Edit Attribute' tab selected. The 'Name' field contains 'Colour'. The 'Values' section is expanded, showing a list of values: 'white', 'black', 'red', and 'green'. Each value has a checkbox next to it. The 'Add' button is highlighted, and the 'Delete' button is also visible. Callouts explain the functionality: 'The selected attribute value of the Values group is added to the Selected Values group.' (pointing to the 'Add' button), 'Selectable attribute value list. Check the attribute value to be added to the Selected Values group.' (pointing to the checkboxes), 'The selected attribute value is deleted from the Selected Values group.' (pointing to the 'Delete' button), and 'Selectable attribute value list. Check the attribute value to be deleted.' (pointing to the checkboxes).

14.10.9.3 Type F

The screenshot shows the 'Attribute Setting' dialog with the 'Edit Attribute' tab selected. The 'Name' field contains 'Buried depth'. The 'Value' field contains '0.0'. The 'No Known Value' checkbox is checked. Callouts explain the functionality: 'Enter an attribute value.' (pointing to the 'Value' field) and 'Check when the attribute value is unknown.' (pointing to the 'No Known Value' checkbox).

14.10.9.4 Type I

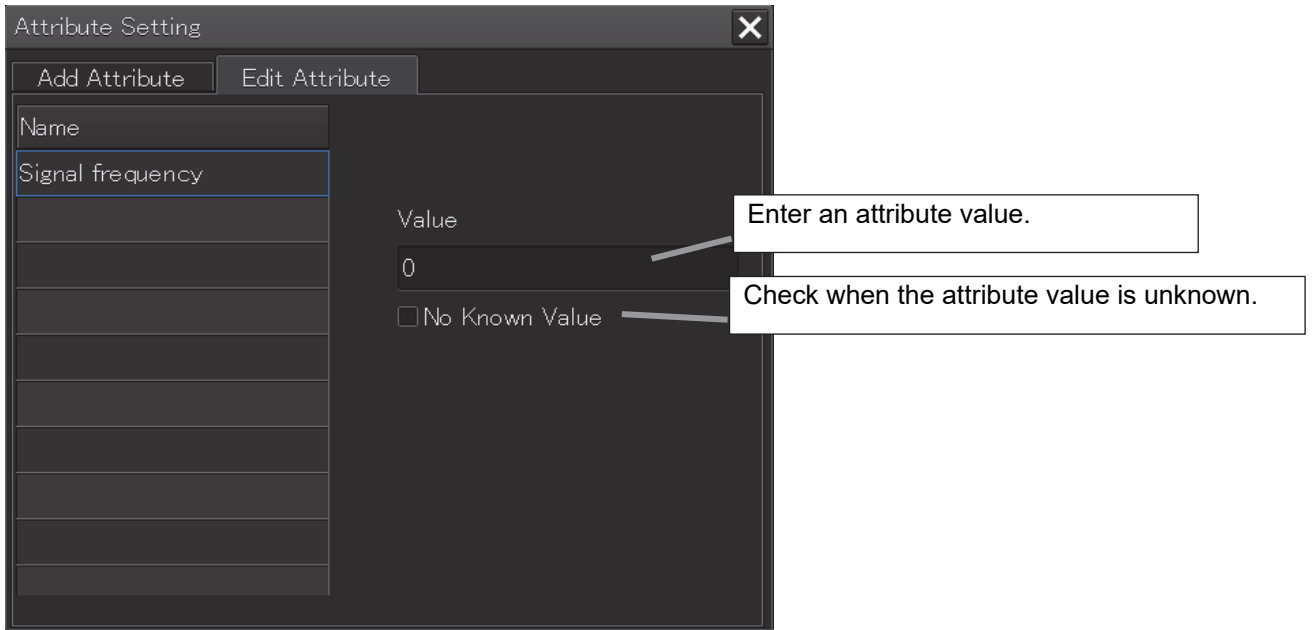



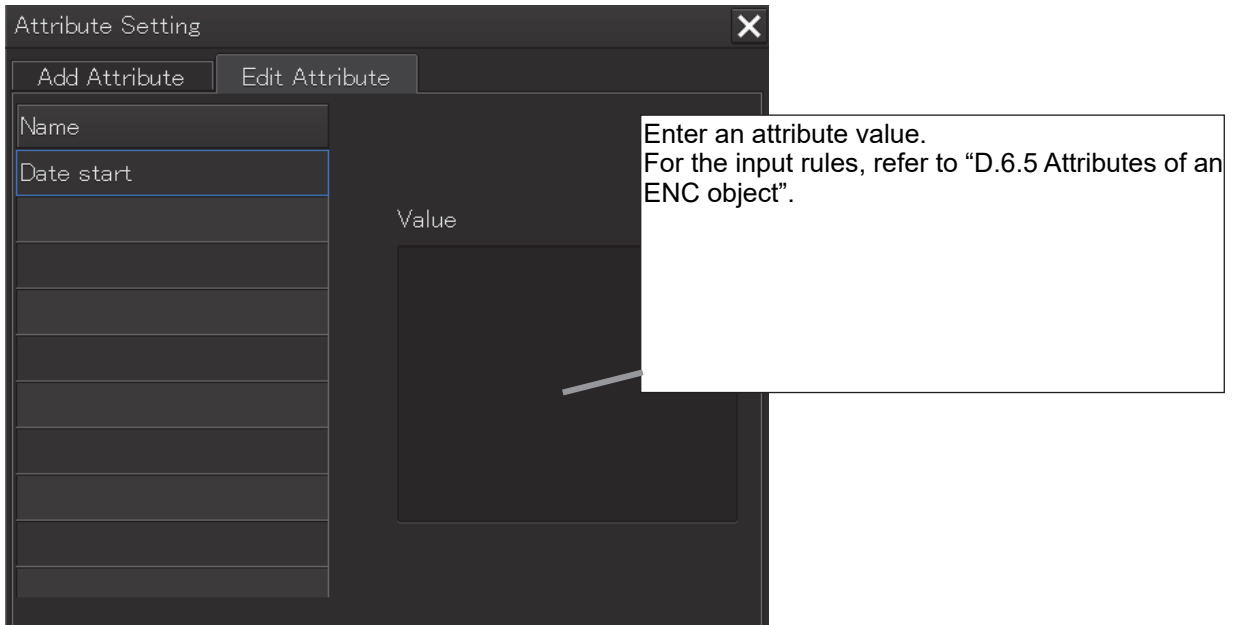







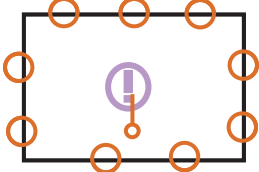





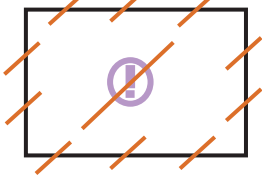



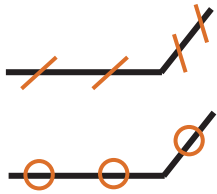





14.10.9.5 Type A/S

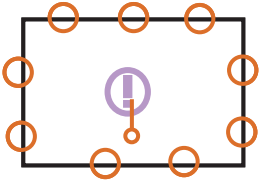

14.10.10 Highlighted display of an object

Highlighted display of a manual update object varies depending on the editing operation or the geometry.

Operation	Geometry	Before update	After update
Adding an object	Point	(No object)	
	Line	(No object)	
	Area	(No object)	
Deleting an object	Point		
	Line		
	Area		
Moving an object (Deletes the moving source and highlights the moving destination at addition)	Point		
	Line		

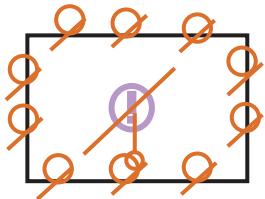
Operation	Geometry	Before update	After update
	Area		
Editing an object (Addition of ENC object attribute only)	Point		
	Line		
	Area		
Editing an object (Changing the attribute of the ENC object)	Point		
	Line		
	Area		

Highlighted display of manual update in route monitoring indicates the difference with the manual update operation performed against the latest automatic update chart status.

Example

(1) Latest status of automatic update

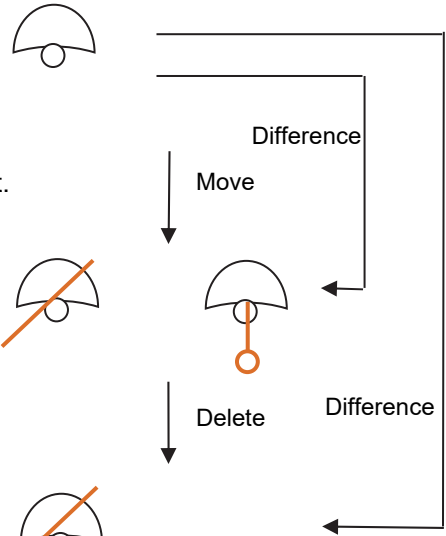

(2) Move the ENC object in manual update mode and save it.

End the manual update mode.

The state of moving from the latest status of automatic Update is indicated.



(3) Restart the manual update mode and delete the ENC object that was moved by the previous editing.

The state of deleting of the latest status of the automatic update is indicated.





Highlighted display of manual update in manual update mode indicates the difference with the manual update operation that is performed against the state that has been saved previously.

Example

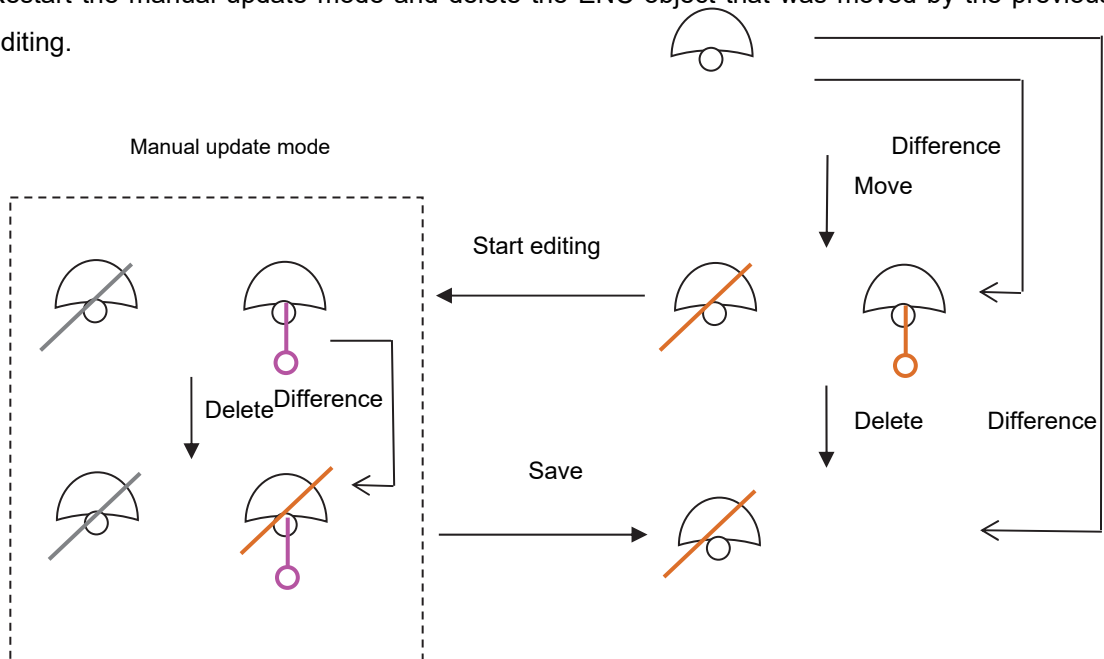
(1) Restart the manual update mode and delete the ENC object that was moved by the previous editing.



  These highlight symbols are manual update symbols that have been saved previously. The symbol in magenta can be picked by the cursor. The symbol in grey cannot be picked by the cursor.

14.10.11 Reviewing manual update

(1) Reviewing manual update

The review function can be used for checking the update history on the screen in chart units. In review display mode, "Review" is displayed in the Cursor mode column and manual update operation is disabled.

When a chart is updated in Chart Maintenance mode, the manual update operations that have been performed up to then cannot be displayed for review.

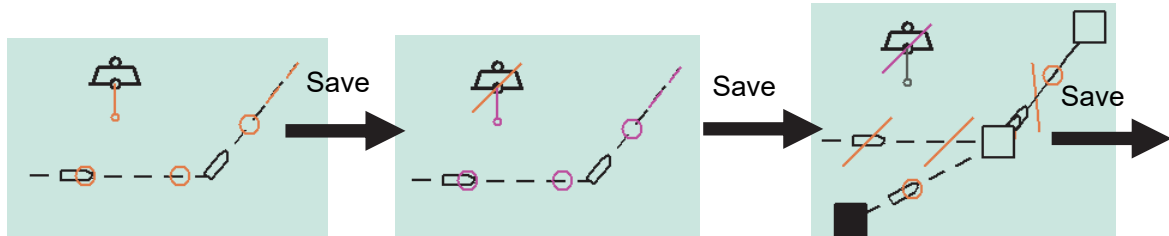

[1] Add a buoy and a ferry route.

[2] Delete the buoy.

[3] Change the ferry route.

A review display example for the above editing is shown below.

Review for the 1st editing (addition of a buoy and a ferry route) is displayed.

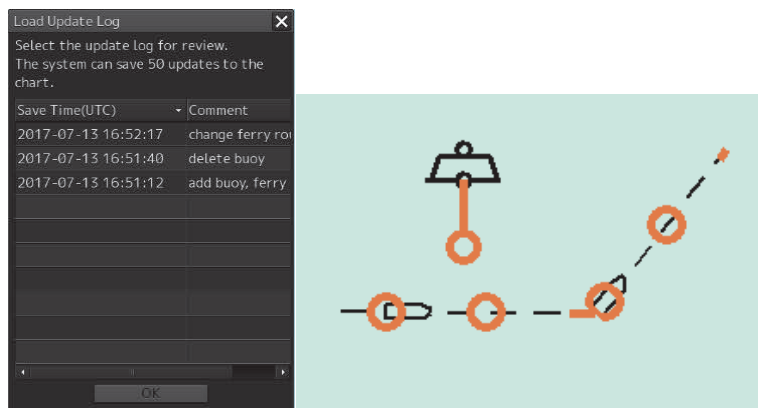

Review for the 2nd editing (deletion of the buoy) is displayed.

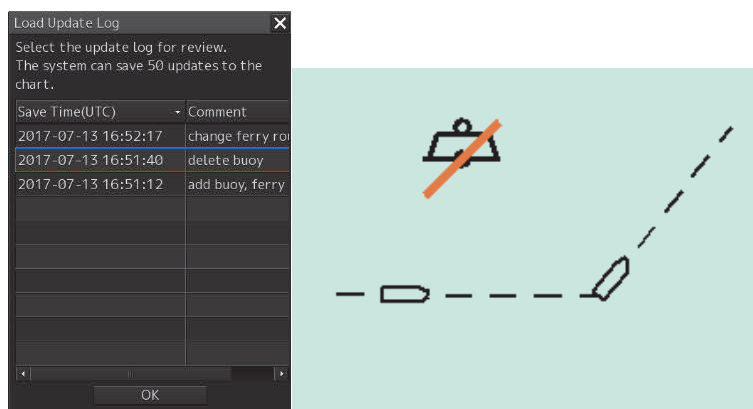

Review of the 3rd editing (change of the ferry route) is displayed.

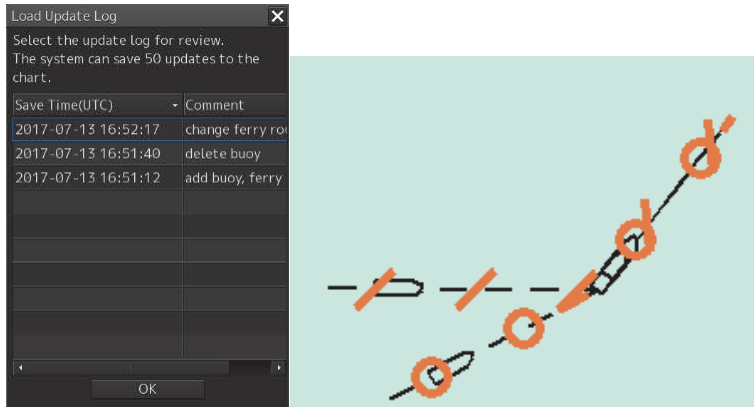

To enter in this mode, use the following procedure on a normal menu.

- 1) Select [Menu]-[Chart]-[Manual Update].
- 2) Select a chart to be reviewed by clicking on the [Select Chart] button.
- 3) Click on the [Load] button and open the Load Update History dialog.
- 4) Select a history to be reviewed and click on the [OK] button.
- 5) Check [Review] on the tool bar.

(By maintaining [Review] checked, history can be displayed subsequently by performing 3) and 4).)

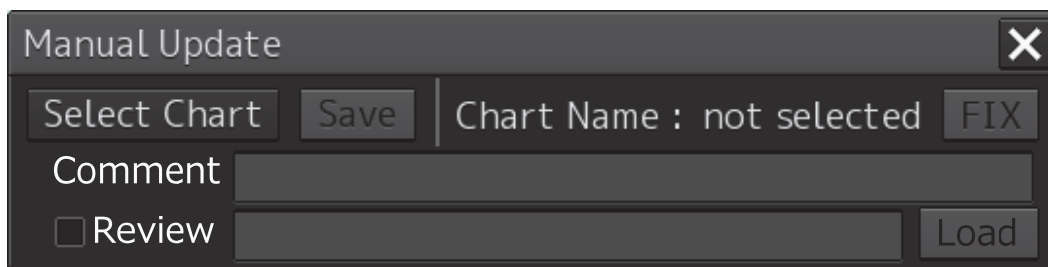

Note

Comments can not be written in C-MAP.

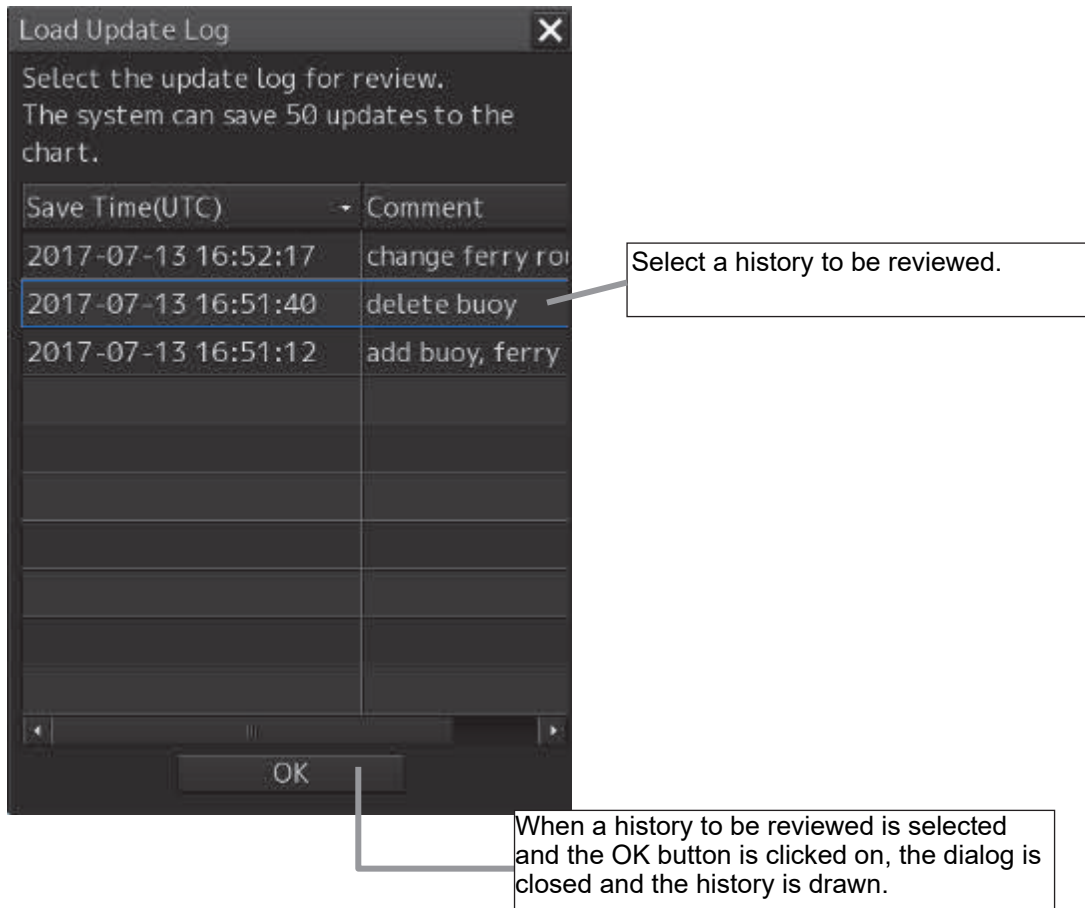

(2) Displaying manual update history

The manual update editing contents are output to the update log of the chart in text format.

- 1) Click the right mouse button on the chart and select [Cursor Pick...].
- 2) Select [Update log] on the [Pick Report] dialog box. The update editing contents are displayed following <MANUAL> in text format.

.....

Hint!

- The history indicates the difference between the unsaved information and the saved information. For instance, when, in edit mode, [1] an object is added to the initial position, [2] the object is moved, and [3] the edited contents are saved, the history indicates the new addition to the last position to which the object was moved.
- The latitude and longitude that are output to the history indicates only one coordinate point of the edited line object or the area object. This does not indicate the coordinates of the vertex to which the object was moved.

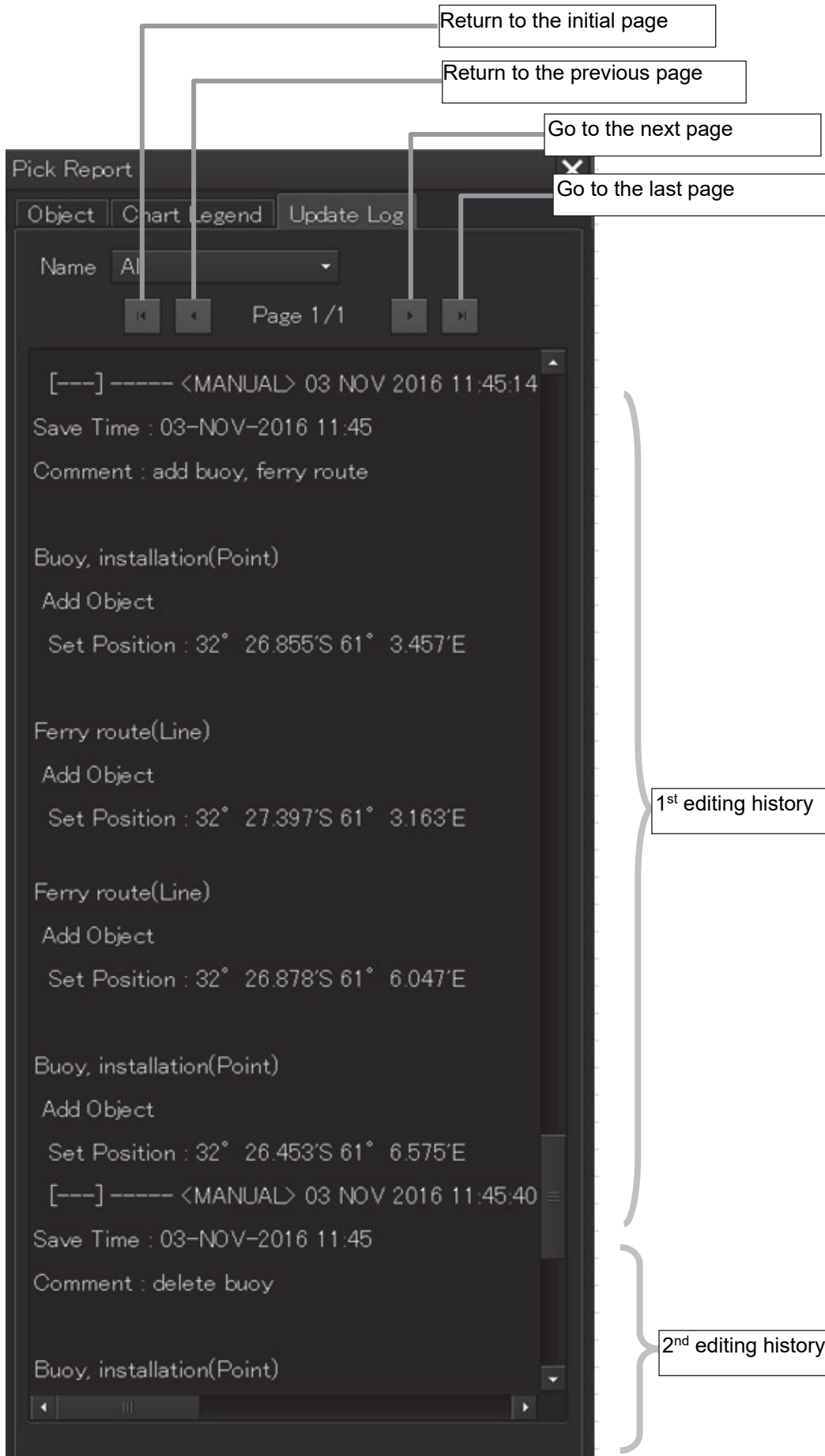

14.10.12 Object Delete function

The Delete function attaches a deletion symbol on the ENC object or saved manual update object that is targeted.

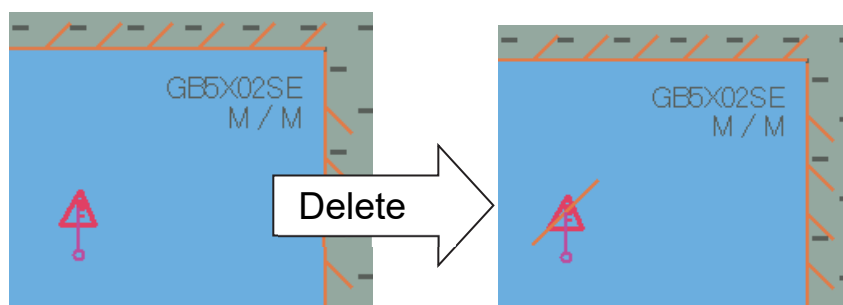

If Delete is executed for the object that was added after the start of editing, the object is deleted.

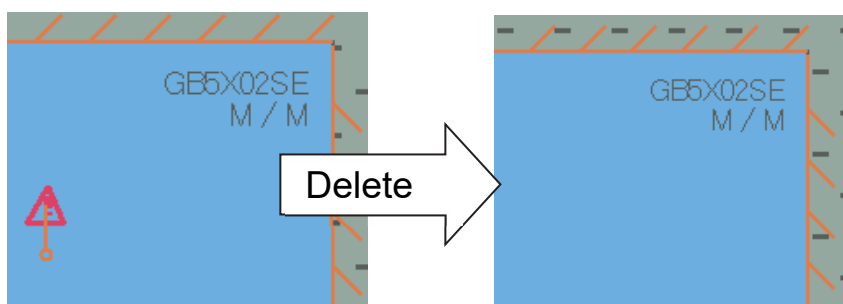

Operation/duration	Operation
Delete operation for the unsaved manual update object	Deletes the object that was operated.
Delete operation for the ENC object and saved manual update object	Attaches a deletion symbol (orange diagonal line) on the object that was operated.
Required or not required to save	Required to save
Retention period	Not discarded automatically.
Delete operation during Review	Not allowed
Editing the deleted object	Only Remove is allowed.
Picking the deleted object	Not allowed

Execution procedure

This function can be executed from the context menu only.

Display the context menu by clicking the right mouse button on the object and select 'Delete this object'.

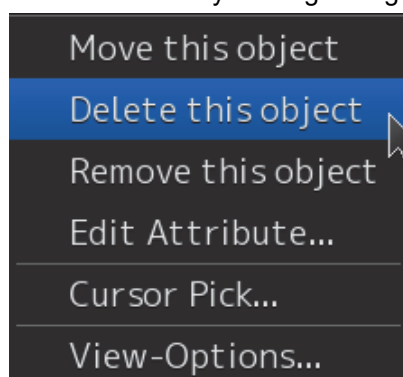

14.10.13 Object Remove function

A saved manual update object can be hidden by using the Remove function. The target object can be hidden without attaching a deletion symbol (orange diagonal line).

By using this function, the information on the removed object can be retained for 3 months (90 days) and can be redisplayed from the history by using the Review function.

The information of the object that has been removed 91 days or earlier can no longer be redisplayed by the Review function.

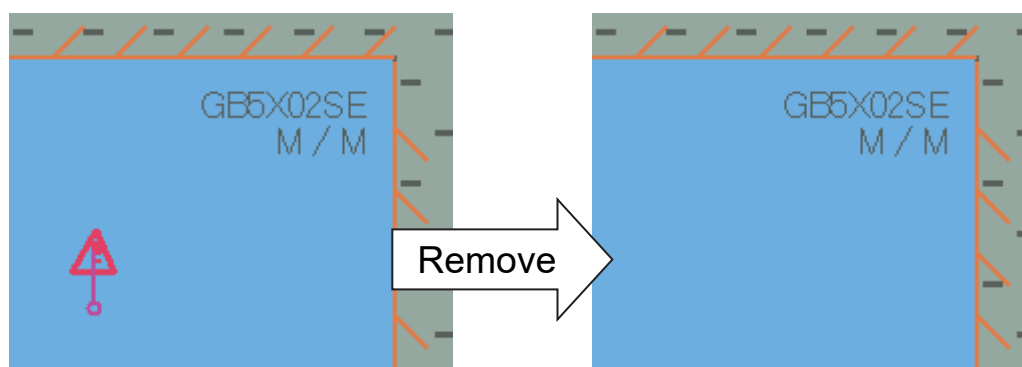

Operation/duration	Remarks
Remove operation for the ENC object	Not possible
Remove operation for the saved manual update object	Hides the manual update object that was removed
Required to save or not required to save	Required
Retention period	90 days
Remove operation during Review	Not possible
Picking the removed object	Not possible

Execution procedure

This function can be executed from the context menu and the eraser tool.

(1) Context menu

Display the context menu by clicking the right mouse button on the object and select 'Remove this object'.

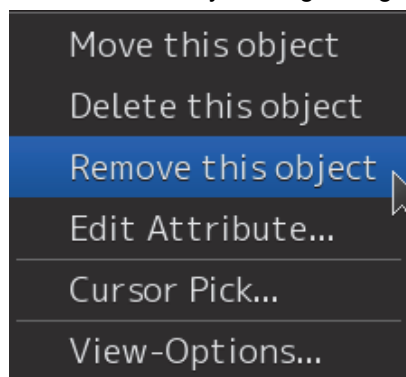

(2) Eraser tool

For the details, refer to “14.9.1 Deleting or hiding an object”.

(3) Discard manual update information by self update

If the chart's edition changes, all manual update information will be discarded.

14.11 Displaying a Pick Report of Manual Update Objects

The display conditions of a pick report of manual update objects are indicated below.

Item	Display
Saved manual update object (ENC)	Allowed
Saved manual update object (non-ENC)	Not allowed
Unsaved manual update object	Not allowed
Manual update object during Review	Allowed
Delete manual update object	Not allowed
Removed manual update object	Not allowed
ENC object	Allowed

Section 15 Logbook

Various types of information (events) during the voyage can be recorded/displayed in a logbook.

15.1 Browsing a Logbook

- 1 Click on the [Menu] button on the left toolbar.

The menu is displayed.

- 2 Click on [Logbook] on the menu.

The [Logbook] dialog box appears.

The screenshot shows the Logbook dialog box with a date selection box set to 2014-05-18 and an Event group tab selected. The Event list table contains the following data:

No.	Date(LMT)	Event
231	2014-05-18 21:10	Specified Period
230	2014-05-18 21:00	Specified Period
229	2014-05-18 20:50	Specified Period
228	2014-05-18 20:40	Specified Period
227	2014-05-18 20:30	Specified Period
226	2014-05-18 20:20	Specified Period
225	2014-05-18 20:10	Specified Period
224	2014-05-18 20:00	Specified Period
223	2014-05-18 19:50	Specified Period
222	2014-05-18 19:40	Specified Period
221	2014-05-18 19:30	Specified Period
220	2014-05-18 19:20	Specified Period
219	2014-05-18 19:10	Specified Period
218	2014-05-18 19:00	Specified Period
217	2014-05-18 18:50	Specified Period
216	2014-05-18 18:48	Event Mark
215	2014-05-18 18:40	Specified Period
214	2014-05-18 18:30	Specified Period
213	2014-05-18 18:20	Specified Period
212	2014-05-18 18:10	Specified Period
211	2014-05-18 18:05	Manual Position Fix
210	2014-05-18 18:00	Specified Period
209	2014-05-18 17:50	Specified Period

The Event detail information panel shows the following data for the selected event (No. 231):

- Event: Specified Period, 2014-05-18 21:10 -09:00
- Position: 32°28.470'S, 61°00.070'E
- Course/Speed: HDG 255.3°, STW 2.0 kn, COG 255.3°, SOG 2.0 kn, Av.(4h) 2.0 kn, Av.(24h) 13.3 kn
- Depth: **** m
- Chart: GB4X0000
- Current: Set, Drift
- Wind: Dir. ****°, SPD **** kn, BFT
- Wave: Dir. ****°, Height *** m
- Voyage Distance: (Ground) 63.53 NM, (Water) 63.26 NM
- Engine Rev.: 1000.0 RPM
- Weather: Air Pressure **** hPa, Air Temperature *** °C, Water Temperature *** °C, Weather Condition
- Comment: [Empty text area]

Memo
Events that are recorded/displayed in a logbook can be changed by using the [Settings] menu. For the details, refer to "18.16 Setting Logbook".

The following events are recorded in a logbook.

- At Noon: Recorded at 12:00 (LMT) every day.
- Specified Period: Recorded at any time interval.
- Event Mark: Recorded at marking an event mark.
- Manual Position Fix: Recorded at fixing a position manually.
- Chart Manual Updating: Recorded at updating a chart manually.
- System Start: Recorded at the start of the system.
- System Exit: Recorded at the termination of the system.
- Route Alert: Recorded at the occurrence of a Route-related alert.
- Chart Alert: Recorded at the occurrence of a Chart-related alert.
- Auto Sail Alert: Recorded at the occurrence of an automatic sailing related-alert and sensor alarm
- System Alert: Recorded at the occurrence of an alert that does not belong to the types that are indicated above
- MOB Start: Recorded when MOB starts.
- MOB Stop: Recorded when MOB stops.

Searching an event based on the date

Enter a date and time in the date selection box.

The events of the date and time that were input are searched. The event list is scrolled and the line of the first event is highlighted in blue.

Sorting events

When turning on the power, events are registered in the event list starting from the event of the latest date.

When any of the items of the title line in the event list is clicked on, the events can be sorted based on the item. Whenever the item is clicked on, the events are sorted in the ascending order or descending order.

Switching the event groups

Events are classified into the following three event groups. When any of these tabs is clicked, the associated events are displayed.

- [User Task Log] tab: Displays the events relating to user operations.
- [Navigation Alert Log] tab: Displays the events relating to navigation alerts.
- [System Alert Log] tab: Displays the events relating to system alerts.

15.1.1 Event detail information

Navigation record data is displayed as event detail information.

The screenshot shows a software interface for event details. At the top, there are three columns: 'Date', 'Time', and 'Time difference'. The main form contains several sections:

- Event name:** Specified Period
- Date/Time:** 2014-05-18 21:10
- Time difference:** -09:00
- Event descriptions:** Descriptions
- Own ship's position:** Position (32°28.470'S, 61°00.070'E)
- Position sensor type 1:** POSN1 (GPS1)
- Position sensor type 2:** POSN2
- Water depth:** Depth (**** m)
- Chart name:** Chart (GB4X0000)
- Course/Speed:** HDG (255.3°), STW (2.0 kn), COG (255.3°), SOG (2.0 kn), Av.(4h) (2.0 kn), Av.(24h) (13.3 kn)
- Current direction:** Set (****°)
- Current speed:** Drift (**** kn)
- Wind:** Dir. (****°), SPD (**** kn), BFT (****)
- Wave:** Dir. (****°), Height (**** m)
- Voyage distance (ground):** (Ground) (63.53 NM)
- Voyage distance (water):** (Water) (63.26 NM)
- Engine revolution:** Engine Rev. (1000.0 RPM)
- Weather:** Air Pressure (**** hPa), Air Temperature (****°C), Water Temperature (****°C), Weather Condition (****)
- Comment:** Comment

Labels on the right side of the form point to specific fields:

- Ship's heading
- Speed through the water
- Course over the ground
- Speed over the ground
- 4-hour average of SOG
- 24-hour average of SOG
- Wind direction
- Wave direction
- Wave height
- Wind speed
- Beaufort scale
- Air pressure
- Air temperature
- Water temperature
- Weather condition

Detail information that can be edited

The information below can be edited during browsing.

- [Depth] (Water depth):** Enter a value within the range from 0 to 999.9 m.
- [Engine Rev.] (Engine revolution):** Enter a value within the range from -9999.9 to 9999.9 rpm.
- [Wind Dir.] (Wind direction):** Enter a value within the range from 0 to 359.9°.
- [Wind SPD] (Wind speed):** Enter a value within the range from 0 to 200.0 kn.
- [Wave Dir.] (Wave direction):** Enter a value within the range from 0 to 359.9°.
- [Wave Height] (Wave height):** Enter a value within the range from 0 to 50.0 m.
- [Air Press.] (Air pressure):** Enter a value within the range from 0 to 2000.0 hPa.
- [Air Temp.] (Air temperature):** Enter a value within the range from -50.0 to 99.9°C.
- [Water Temp.] (Water temperature):** Enter a value within the range from -10.0 to 50.0°C.

The information below can be input manually. The setting can be selected from the list.

[Beaufort scale]

- 0: Calm
- 1: Light air
- 2: Light breeze
- 3: Gentle breeze
- 4: Moderate breeze
- 5: Fresh breeze
- 6: Strong breeze
- 7: Near gale
- 8: Gale
- 9: Strong gale
- 10: Storm
- 11: Violent storm
- 12: Hurricane

[Weather condition]

- b: Blue sky
- bc: Fine but cloudy
- c: Cloudy
- o: Overcast
- r: Rainy
- q: Squalls
- s: Snow
- f: Foggy

A comment can be input in the [Comment] box by using up to 1000 characters.

15.2 Editing a Logbook

15.2.1 Adding an event

1 Click on the [Event] button.

An event mark is plotted at the own ship's position. An event called "Event Mark" is created with the current time and is registered in the top line of the event list.

The navigation data that has been acquired automatically is displayed as event detail information.

Memo

The data that is not automatically acquired is displayed as blank space.

The screenshot shows the Logbook application window. At the top, there is a date selector set to 2014-05-18 and an [Event] button. Below this are three tabs: User Task Log, Navigation Alert Log, and System Alert Log. The main area is a table with columns for No., Date(LMT), and Event. The table contains a list of events, with the most recent one (No. 231) highlighted. An arrow points to the [Event] button with the label "[Event] button". Another arrow points to the first row of the table with the label "Created event". To the right of the table is a detailed view for the selected event, showing various navigation parameters such as Position (32°28.470'S, 61°00.070'E), Course/Speed (HDG 255.3°, STW 2.0 kn), Depth (**** m), Chart (GB4X0000), Current (Set, Drift), Wind (Dir, SPD, BFT), Wave (Dir, Height), Voyage Distance (Ground 63.53 NM, Water 63.26 NM), Engine Rev. (1000.0 RPM), and Weather (Air Pressure, Air Temperature, Water Temperature, Weather Condition). A Comment field is also present at the bottom.

No.	Date(LMT)	Event
231	2014-05-18 21:10	Specified Period
230	2014-05-18 21:00	Specified Period
229	2014-05-18 20:50	Specified Period
228	2014-05-18 20:40	Specified Period
227	2014-05-18 20:30	Specified Period
226	2014-05-18 20:20	Specified Period
225	2014-05-18 20:10	Specified Period
224	2014-05-18 20:00	Specified Period
223	2014-05-18 19:50	Specified Period
222	2014-05-18 19:40	Specified Period
221	2014-05-18 19:30	Specified Period
220	2014-05-18 19:20	Specified Period
219	2014-05-18 19:10	Specified Period
218	2014-05-18 19:00	Specified Period
217	2014-05-18 18:50	Specified Period
216	2014-05-18 18:48	Event Mark
215	2014-05-18 18:40	Specified Period
214	2014-05-18 18:30	Specified Period
213	2014-05-18 18:20	Specified Period
212	2014-05-18 18:10	Specified Period
211	2014-05-18 18:05	Manual Position Fix
210	2014-05-18 18:00	Specified Period
209	2014-05-18 17:50	Specified Period

Deleting an event mark

For deletion of event marks, refer to "8.12 Marking the Position of Own Ship with an Event Mark".

15.2.2 Editing event detail information

Use the procedure that is shown below to edit the event detail information that can be edited.

For the detail information that can be edited, refer to "Detail information that can be edited" in "15.1.1 Event detail information".

- 1 Click on the box of the data that can be edited.**



Depth 30.0 m

- 2 Edit the information by using the software keyboard.**

- 3 Click on the [Enter] key.**

The editing is determined and the data is stored.

15.3 Outputting Event Data

By selecting an event, the detail information can be output as a file.

15.3.1 Outputting a logbook as a file

A logbook data can be output with "File Manager".

- 1 Click on the [Menu] button on the left toolbar.**
The menu is displayed.
- 2 Click on the [Tools] - [File Manager] on the menu.**
The [File Manager] dialog box appears.
- 3 Click on the [File Management] tab.**

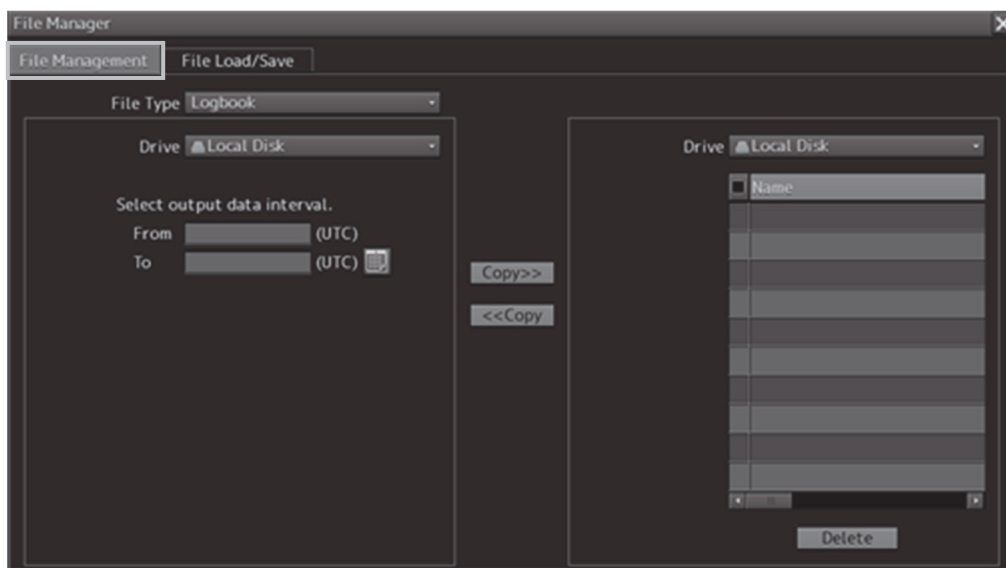

- 4 Select the [Logbook] from the [File Type] combo box.**
- 5 Select the drive containing logbook data from the [Drive] combo box.**

- 6** Input the period of the logbook data to be output in [From] and [To] of [Select output data interval.].

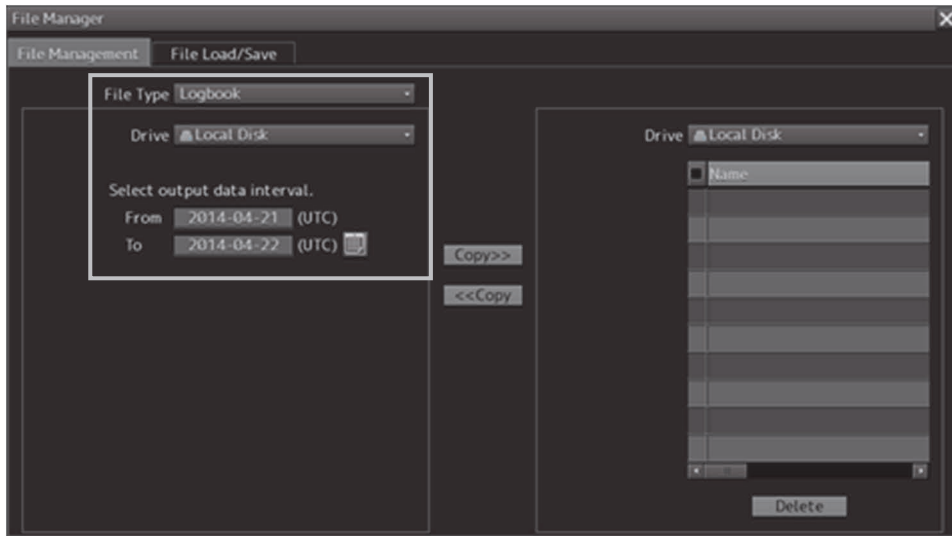

The [Copy] button is enabled.

- 7** Select the storage destination of the logbook data from the [Drive] combo box of the output destination.

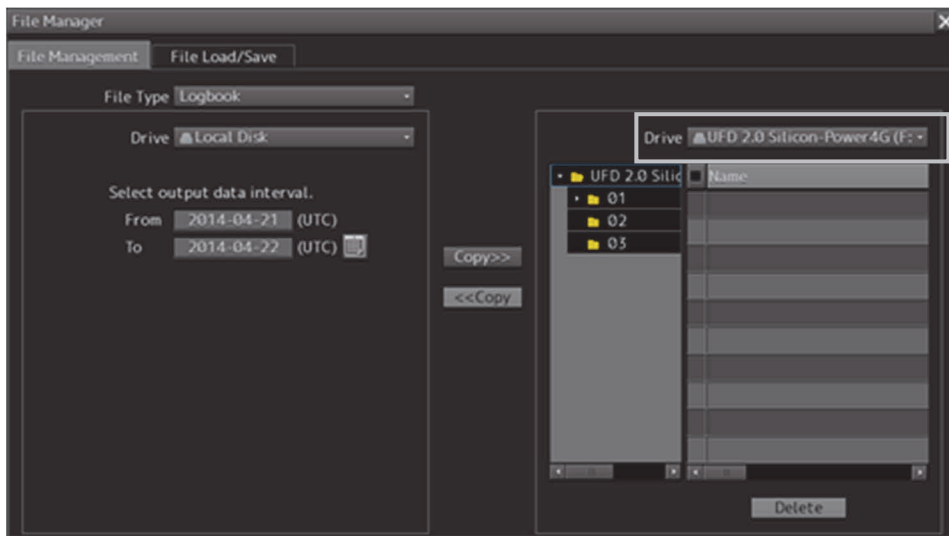

8 Click on the [Copy] button.

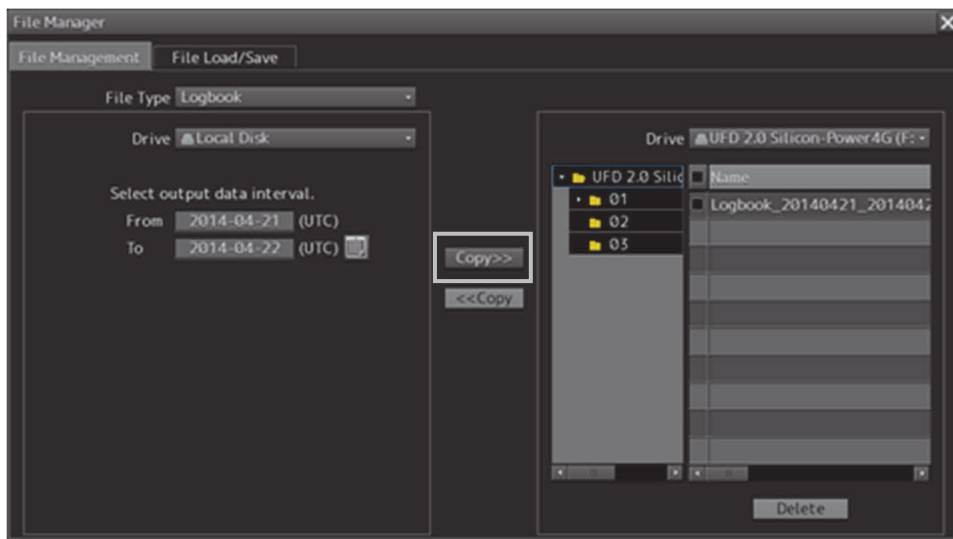



Section 16 Setting up Screen View

Screen display detail is set through the [View] menu.

The display procedure of the View setup dialog box is as follows.

- 1 Click on the [Menu] button on the left toolbar.**

The menu is displayed.

- 2 Click on the [View] button on the menu.**

The submenu is displayed.

The submenu contents vary between RADAR and ECDIS.

[RADAR]

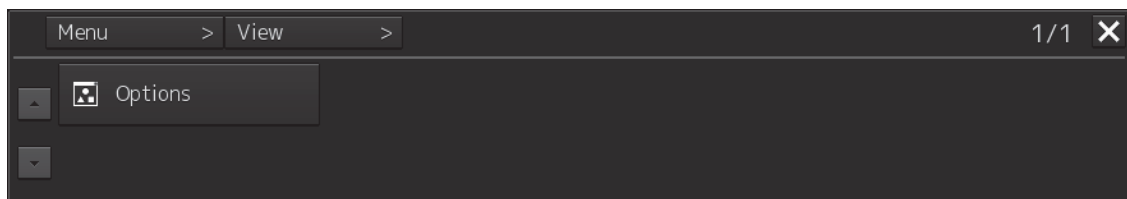

[ECDIS]

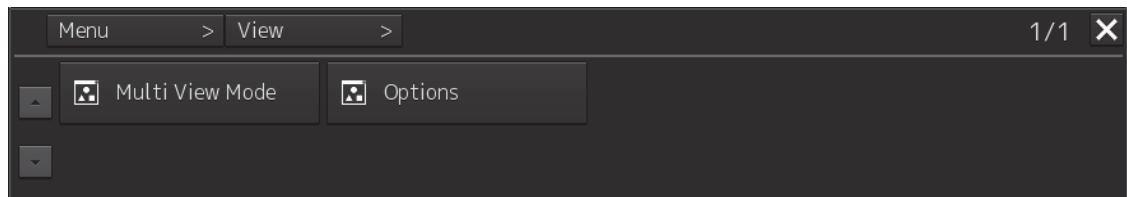

When submenu buttons are clicked, their respective setup dialog boxes are displayed.

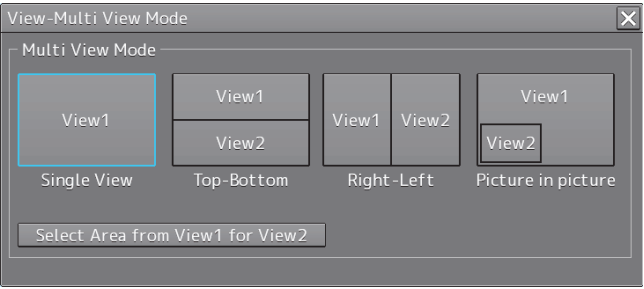
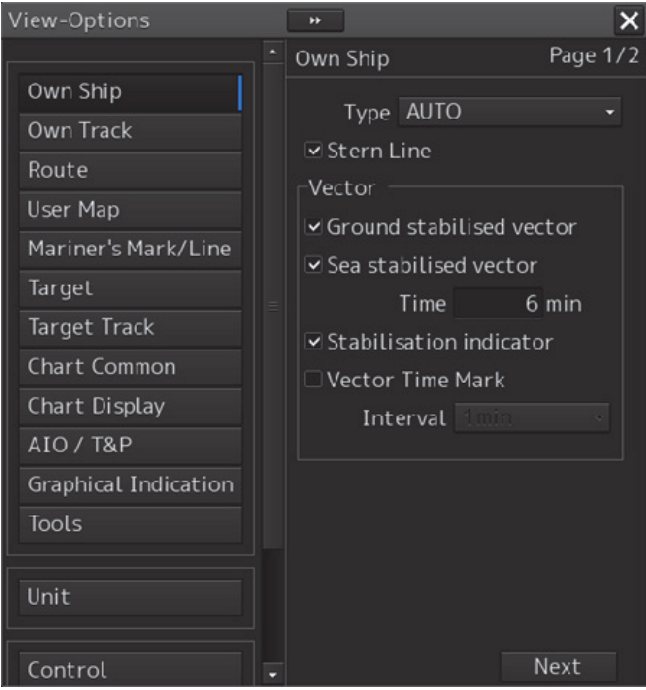
Button	Dialog box	Reference
Multi View Mode		16.1 Setting Chart Display Mode (Multi View Mode) (ECDIS only)
Options	 <p>*The setting items may vary between RADAR and ECDIS.</p>	16.2 Setting Screen Display Options

16.1 Setting Chart Display Mode (Multi View Mode) (ECDIS only)

In the [View-Multi View Mode] dialog box, chart display modes can be set.

16.1.1 Setting Multi-Screen

For details about how to use the multi-screen, refer to "8.10.1 Display of multi view."

- 1 Click on the [Menu] button on the left toolbar.**
The menu is displayed.
- 2 Click on [View] - [Multi View Mode] on the menu.**
The [View-Multi View Mode] dialog box appears.

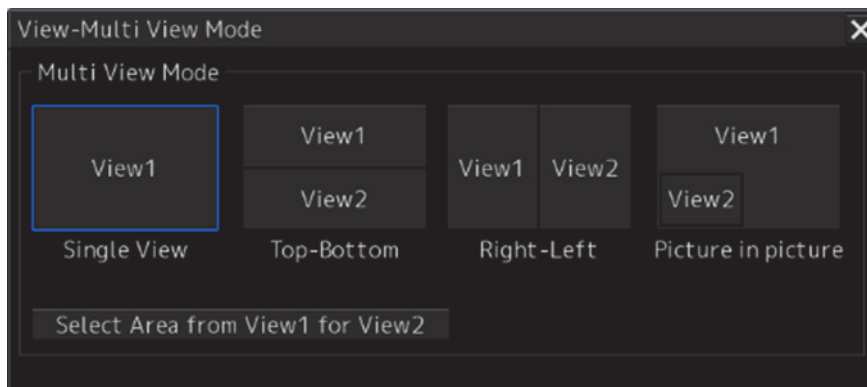

You can select a chart display mode from the following four modes.

- **[Single View] Mode:** Displays a chart in full screen.
- **[Top-Bottom] Mode:** Divides the screen into top and bottom sections; the same or different charts can be displayed in two views of View 1 and View 2.
- **[Right-Left] Mode:** Divides the screen into left and right sections; the same or different charts can be displayed in two views of View 1 and View 2.
- **[Picture in Picture] Mode:** Displays the chart in View 2 on top of the chart in View 1 as a child dialog box.

- 1 Click on the icon of the chart display mode to be used.**
A selection frame appears on the icon of the selected mode.
- 2 Click on the [Select Area from View1 for View2] button.**
The button is highlighted.
- 3 On the chart in View 1, select an area you want to display in View 2.**
The selected area is displayed in View 2.

16.2 Setting Screen Display Options

In the [View-Options] dialog box, the screen display options can be set.

Take the following steps to display the [View-Options] dialog box.

- 1 Click on the [Menu] button on the left toolbar.**
The menu is displayed.
- 2 Click on the [View] - [Options] on the menu.**
The [View-Options] dialog box appears.

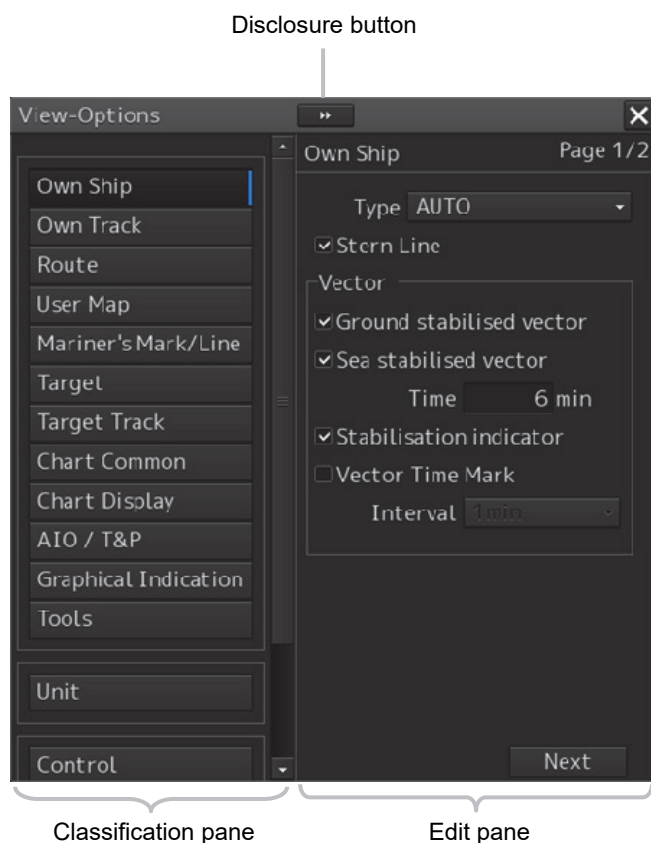

The [View-Options] dialog box consists of the classification pane and edit pane.

Click on the Disclosure button to hide the classification pane.

- 1 Click on the screen view of which you want to set up the options in the classification pane.**
The Option setup dialog box for the screen view you have selected appears in the edit pane.
- 2 Set up in the edit pane.**

Display targets for classification pane

The classification pane displayed in RADAR and ECDIS and reference of the explanation are as follows.

Classification pane	Display target		Reference
	RADAR	ECDIS	
Own Ship	○	○	16.2.1 Setting up the display of Own Ship symbol
Own Track	-	○	16.2.2 Setting up the display of ECDIS own ship's track
Own Track	○		16.2.3 Setting up the display of RADAR own ship's track
Route	○	○	16.2.4 Setting up the display of Route Monitoring 14.2.5 Changing the color of the alternative route
User Chart	○	○	16.2.6 Setting up the display of User Chart
Mariner's Mark/Line	-	○	16.2.7 Setting up the display of Mariner's Mark/Line
RADAR	○	○	16.2.8 Setting up Radar Overlay and Transparency of Echo/Trails
Target	○	○	16.2.9 Setting up the display of TT/AIS Target
Target Track	○	○	16.2.10 Setting up the display of Other Ship's Track
Chart Common	○	○	16.2.11 Setting up the display of Chart Common
Chart Display	○	-	16.2.12 Setting up the display of RADAR Chart
Chart Display	-	○	16.2.13 Setting up the display of ECDIS Chart
AIO	○	○	16.2.14 Setting up AIO/T&P display
Graphical Indication			16.2.15 Set display of danger detection highlight
Tool	○	○	16.2.16 Setting up the display of range/bearing measurement function
Unit	○	○	16.2.17 Setting up the display of Unit of Setting Value
Control	○	○	16.2.18 Setting up display of Own Ship Track Control, display format of Own Ship/Cursor Position and display of Sub-Information dialog
Depth Graph	○	○	16.2.19 Setting up the Water Depth display
Rudder Graph	○	○	16.2.20 Setting up the Rudder graph
Gyro/Rudder Graph	○	○	16.2.21 Setting up the Gyro/Rudder graph
Engine Graph	○	○	16.2.22 Setting up the Engine Graph
ROT	○	○	16.2.23 Setting up the graph range of the ROT slide bar

Screen display set in the [View-Options] dialog box

In the [View-Options] dialog box, the following screen display is set.

Target category	Item
Graphical Objects	Own Ship
	Own Track
	Route
	User Chart
	Mariner's Mark/Line
	RADAR
	Target
	Target Track
	GPS Buoy
	Chart Common
	Chart View
	AIO
	Graphical Indication
	Tools
Unit	Unit
Control	Control

16.2.1 Setting up the display of Own Ship symbol

When you select [Own Ship] in the classification pane, the "Own Ship" dialog is displayed in the edit pane.

Configure the setting for own ship symbols.

The edit pane is divided into two dialogs.

To advance to the next dialog: Click on the [Next] button.

To return to the previous dialog: Click on the [Back] button.

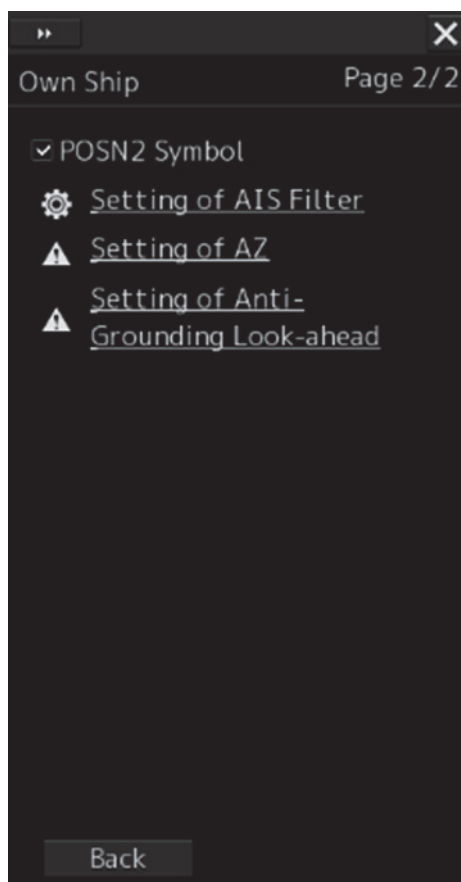
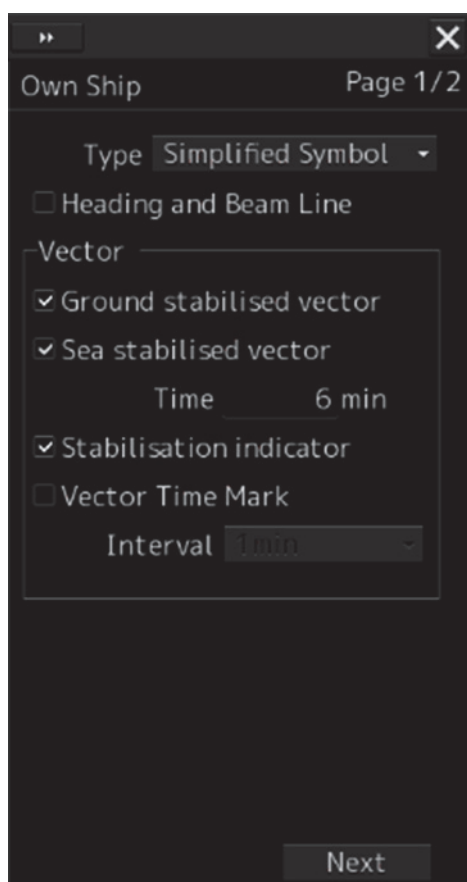

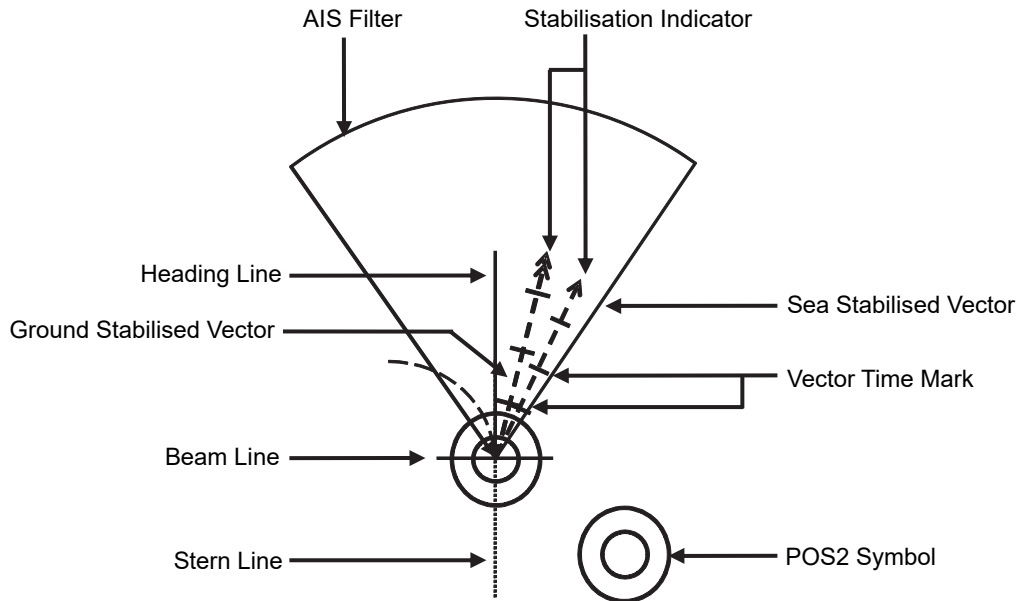

Vector display at primary position



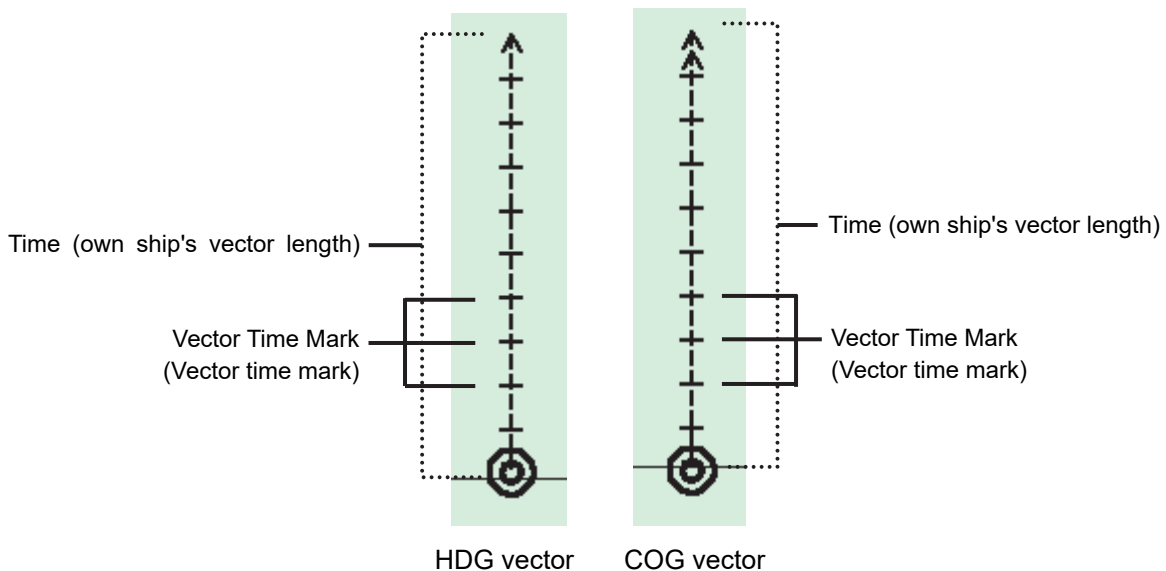

In the own ship symbol, COG (Course Over the Ground) vector, HDG (Heading) vector, and heading line can be displayed. The COG or HDG vector can also be displayed by the length proportionate to the current ship speed in minute by the setting. For example, when the vector length is set to 10 minutes, the vector tip is at the predicted position after 10 minutes if the ship is assumed to navigate at the current speed.



- To display the COG (Course Over the Ground) vector, check [Ground Stabilised Vector] in [Vector].
- To display the HDG (Heading) vector, check [Sea Stabilised Vector] in [Vector].
- To display the heading line, check [Heading and Beam Line].

For details on the setting of type and length of the vector to be displayed, refer to the following table.

The descriptions of settings are shown in the table below.

Setting Item	Description of Setting	Setting Value
Type	<p>Select an own ship symbol from the combo box (symbols of other ships are also linked).</p> <p> : Auto</p> <p> : Simplified Symbol</p> <p> : Outline</p> <p> : Minimized Symbol</p> <p>*In Auto, the display is switched between Outline and Minimized Symbol depending on the size of the symbol. When the beam side of the Outline symbol is 3mm or more, the symbol is displayed in Outline and when the symbol is less than 3mm, it is displayed in Minimized Symbol.</p> <p> The beam side is 3mm or more</p>	<p>For RADAR: AUTO Outline Minimized Symbol [default]</p> <p>For ECDIS: Simplified Symbol [default] Outline</p>
Heading and Beam Line (Heading line/beam line display)	<p>Selecting this enables to display heading lines and beam lines.</p> <p>Note This item can only be set on the ECDIS screen.</p>	<p>To enable: Select. To disable: Clear.</p>
Stern Line	<p>Selecting this enables to display a stern line.</p> <p>Note This item can only set in the RADAR screen.</p>	<p>To enable: Select. To disable: Clear.</p>
Ground Stabilised Vector	<p>Selecting this enables to display a ground stabilised vector.</p>	<p>To enable: Select. To disable: Clear.</p>
Sea Stabilised Vector	<p>Selecting this enables to display a sea stabilised vector.</p>	<p>To enable: Select. To disable: Clear.</p>
Time (Length of own ship's vector)	<p>Enter the own ship's vector length in the box.</p>	<p>0 to 120</p>
Stabilization Indicator	<p>Selecting this enables to display the stabilization indicator.</p> <p>Note When both the Ground Stabilised Vector and the Sea Stabilised Vector are effective, this automatically takes effect.</p>	<p>To enable: Select. To disable: Clear.</p>
Vector Time Mark	<p>Selecting this enables the interval of the vector time mark.</p>	<p>To enable: Select. To disable: Clear.</p>

Setting Item	Description of Setting	Setting Value
Interval (vector time mark interval)	Select a vector time mark interval from the pull-down menu when Vector Time Mark is valid.	1 to 6 min
POS2 Symbol	Selecting this enables to display the POS2 symbol. Note This item may not be displayed depending on the equipment setting. The setting is not possible on the RADAR screen.	To enable: Select. To disable: Clear.

Shortcuts

Click on any of available shortcuts to display the related dialog box.

Shortcut	Setup Dialog
Setting of AIS Filter	[AIS Filter Setting] dialog box
Settings of AZ	[AZ Setting] dialog box
Settings of Anti-Grounding Look-ahead	[Anti-Grounding Look-ahead Setting] dialog box

16.2.2 Setting up the display of ECDIS own ship's track

When you select [Own Track] in the classification pane, the [Own Track] dialog is displayed in the edit pane.

Configure the settings for own tracks.

Information of own tracks is recorded in the SSD at every second. Information of a maximum of 24 hours is displayed on a chart as own tracks.

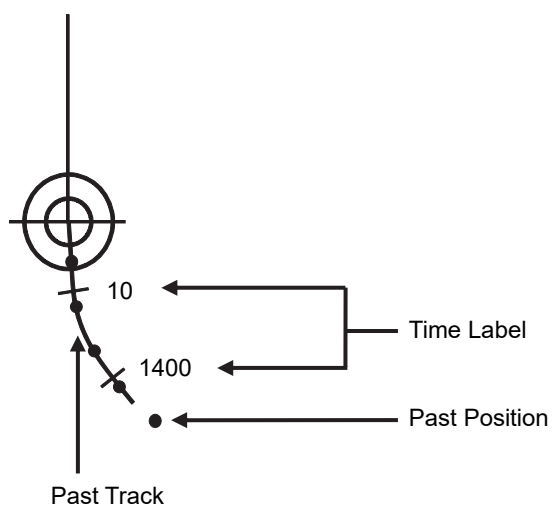
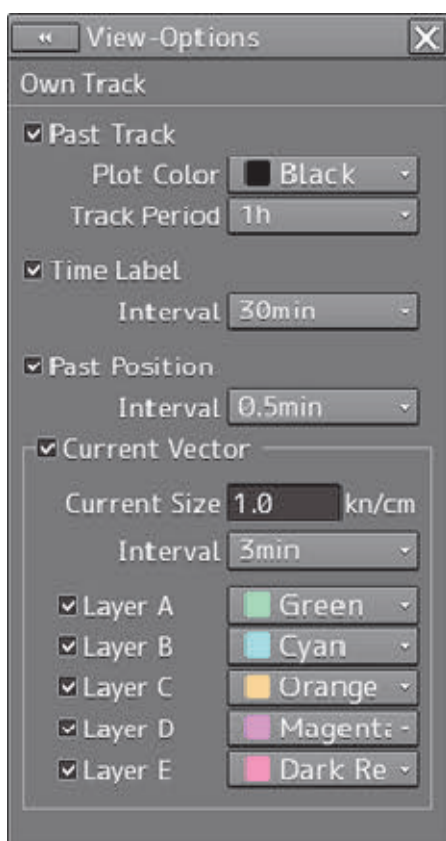

The descriptions of settings are shown in the table below.

Setting Item	Description of Setting	Setting Value
Past Track	Selecting this enables to display the past track.	To enable: Select. To disable: Clear.
Plot Color (plot color of track)	When Past Track is enabled, select a plot color of the track from the list (preview not supported).	White (Black), Gray, Pink, Magenta, Blue, Cyan, Green, Yellow, Orange, Dark Red Note When the background of the screen is being set to Day1 or Day2, Black can be selected instead of White.
Track Period	When Past Track is enabled, select a track period from the list (preview not supported).	1, 2, 4, 6, 8, 12, 16, 24 h
Time Label	Selecting this enables to display the time label interval.	To enable: Select. To disable: Clear.
Interval (time label interval)	When Time Label is enabled, select a time label interval from the list (preview not supported).	1, 3, 5, 10, 30, 60, 120 min
Past Position	Selecting this enables to display the past position.	To enable: Select. To disable: Clear.
Interval (past position interval)	When Past Position is enabled, select an interval of track points from the list (preview not supported).	0.5 min, 1 min, 2 min, 4 min, 0.1 NM, 0.2 NM, 0.5 NM, 1 NM
Current Vector	Enable the current track display by checking the item when Past Track is enabled.	Enable: Check. Disable: Uncheck.
Current Size	Set a vector length when Current Vector is enabled.	0.1 ~ 99.9kn/cm
Interval	When Current Vector is enabled, select the display interval.	3sec, 5sec, 10sec, 30sec, 1min, 3min, 5min, 10min, 30min, 60min, 0.1NM, 0.2NM, 0.3NM, 0.5NM, 1NM, 3NM, 5NM, 10NM
Layer A/B/C/D/E	When Current Vector is enabled, enable the display of each of the layers, A, B, C, D, and E by checking the item.	Enable: Check. Disable: Uncheck.
Color selection combo box	When Layer A/B/C/D/E/F is enabled, select the display color of each item.	White, (Black), Gray, Amber, Magenta, Blue, Cyan, Green, Yellow, Orange, Dark Red

16.2.3 Setting up the display of RADAR own ship's track

If you are using RADAR standalone license, In the **[Service]—[Installation]—[Settings]—[Own Track]** dialog you can switch between ECDIS own ship's track and RADAR own ship's track.

- Plot Interval:1s ... ECDIS own ship's track
- Plot Interval:User Setting(View-Options-Own Track Menu) ... RADAR own ship's track.

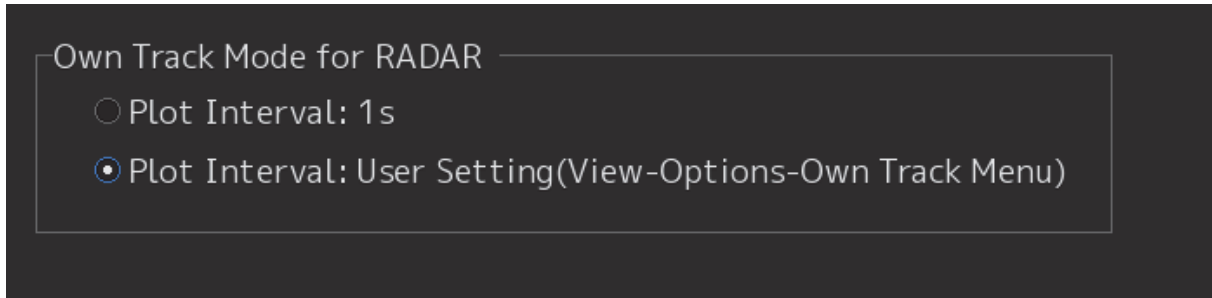

When you select RADAR own ship's track, the contents of the **[View]—[Options]—[Own Track]** dialogue change to the setting of RADAR own ship's track.

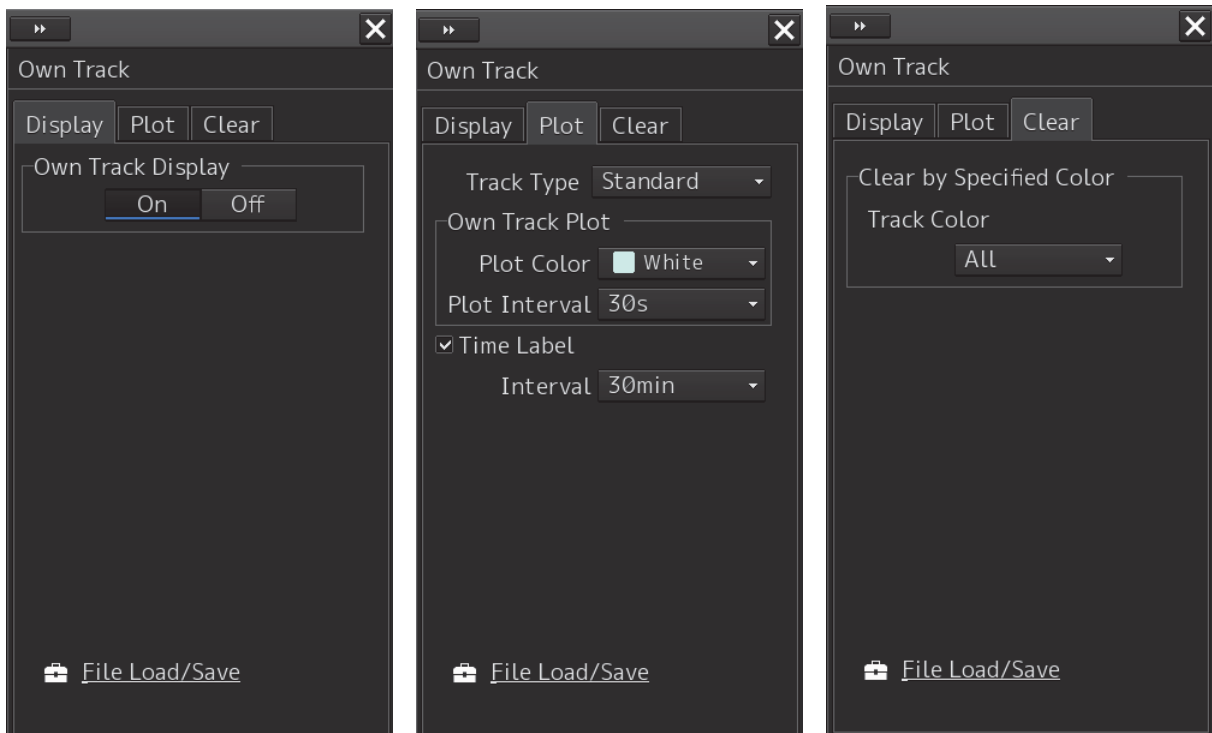

The descriptions of settings are shown in the table below.

Display tab

Setting Item	Description of Setting	Setting Value
Own Track Display	Switching on / off display of own ship's track.	On : Turn on display Off : Turn off display

Plot tab

Setting Item	Description of Setting	Setting Value
Track Type combo box	Selecting type of own ship's track.	Standard : Always selectable
Plot Color combo box	Selecting the track color from the list.	White, Gray, Amber, Magenta, Blue, Cyan, Green, Yellow, Orange, Dark Red
Plot Interval combo box	Selecting the track plot interval from the list.	Off, 3s, 5s, 10s, 30s, 1min, 3min, 5min, 10min, 30min, 60min, 1NM, 3NM, 5NM, 10NM, 0.1NM, 0.2NM, 0.3NM, 0.5NM
Time Label check box	Switching on / off display of Time Label interval.	On : Check Off : Uncheck
Interval combo box	When Time Label is enabled, selecting the Time Label interval from the list.	1min, 3min, 5min, 10min, 30min, 60min, 120min

Clear tab

Setting Item	Description of Setting	Setting Value
Track Color combo box	Selecting and erasing the color of own ship's track. When you select a color, a confirmation dialog will be displayed. Press OK to execute erase.	All, White, Gray, Amber, Magenta, Blue, Cyan, Green, Yellow, Orange, Dark Red

Each tab

Setting Item	Description of Setting	Setting Value
File Load/Save Shortcut	When you click the shortcut, the [File Load / Save] screen of [Tools]-[File Manager] is displayed.	

16.2.4 Setting up the display of Route Monitoring

When you select [Route] in the classification pane, the [Route] dialog is displayed in the edit pane. Configure the settings for route monitoring.

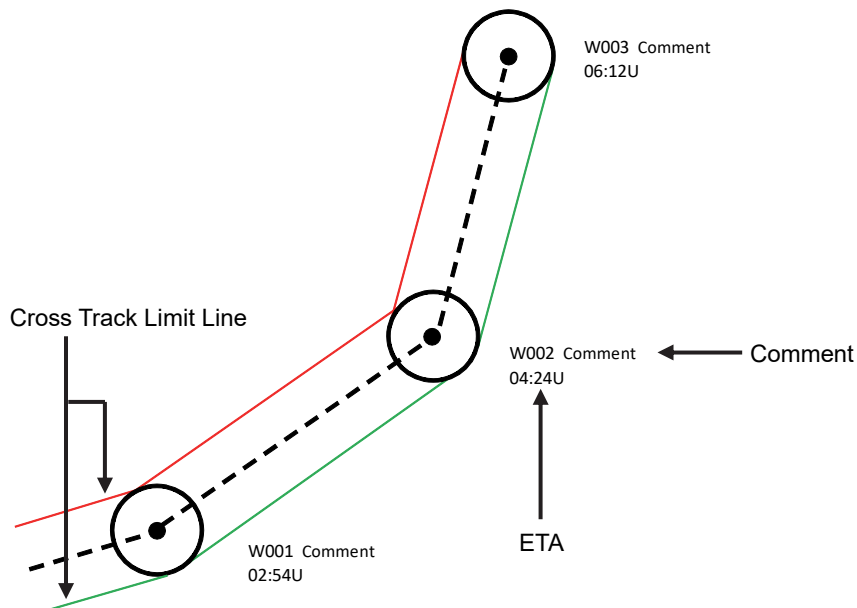
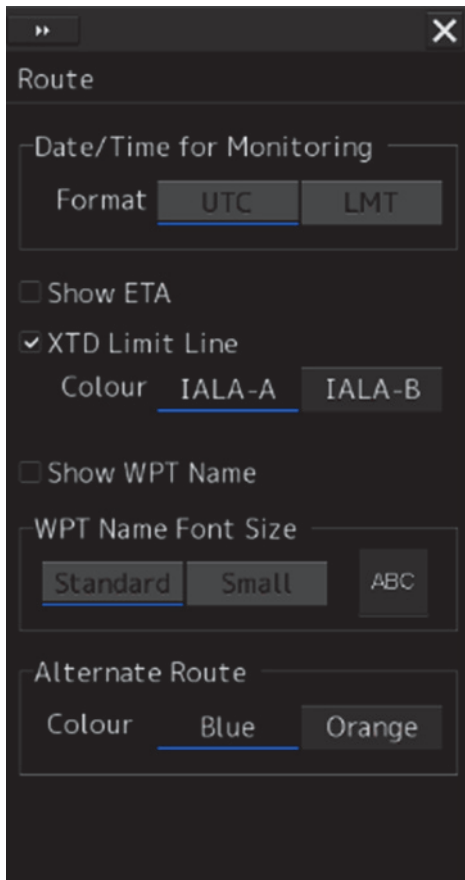

The descriptions of settings are shown in the table below.

Setting Item	Description of Setting	Setting Value
Show ETA	Selecting this enables to display the ETA (estimated time of arrival at WPT) while route monitoring.	To enable: Select. To disable: Clear.
Format	When ETA is enabled, select a display format of the ETA while route monitoring by clicking on the corresponding button. 04:24U : UTC 13:24L : LMT	UTC/LMT
XTD Limit Line	Selecting this enables to display XTD limit lines.	To enable: Select. To disable: Clear.
Color	When XTD Limit Line is enabled, select a display color of XTD limit lines by clicking on the corresponding button. IALA-A: Starboard - green, Port - red IALA-B: Starboard - red, Port - green	IALA-A, IALA-B
Show WPT Name (Comment display)	Selecting this enables to display a comment on the vicinity of the target.	To enable: Select. To disable: Clear.
WPT Name Font Size (Comment font size)	When Show WPT Name is enabled, select a font size of comments by clicking on the corresponding button (preview not supported).	Standard, Small

16.2.5 Changing the color of the alternative route

- 1 Click on the **[Menu]** button on the **Left Tool Bar**.
The menu is displayed.
- 2 Click on **[View] - [Options]** from the menu.
The [View-Options] dialog box is displayed.
- 3 Select **[Route]** (ship track) in the category pain.
The [Route] dialog box is displayed.

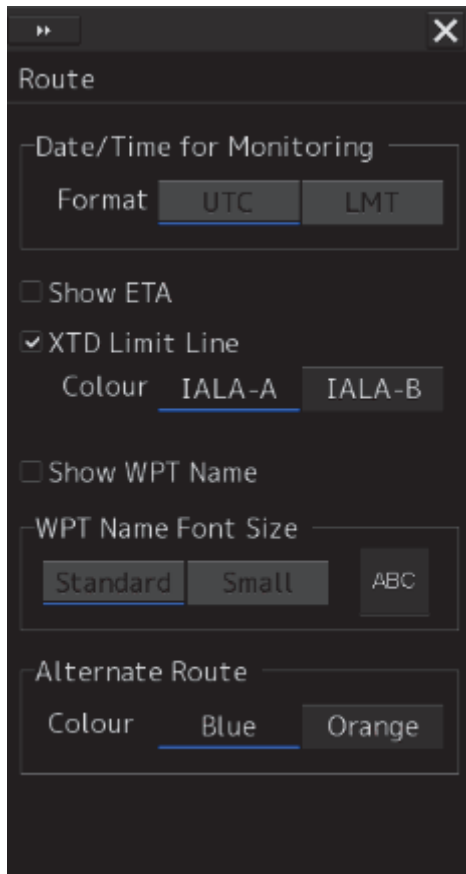

- 4 Select a color in **[Alternate Route]**.
Blue : Displays Alternate Route in blue.
Orange : Displays Alternate Route in orange.

16.2.6 Setting up the display of User Chart

When you select [User Chart] in the classification pane, the [User Chart] dialog is displayed in the edit pane.

Set up the display of User Chart.

The edit pane is divided into two dialogs.

To advance to the next dialog: Click on the [Next] button.

To return to the previous dialog: Click on the [Back] button.

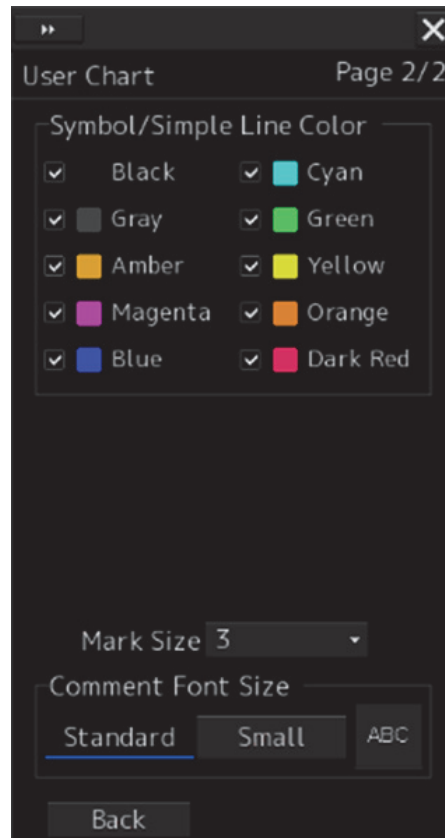

The descriptions of settings are shown in the table below.

Area	Description of Setting	Setting Value
Object Type (Object display condition)	Click on the button to specify whether to display or hide the object mark, and select the mark to be displayed. All On: Displays all marks. Individual: Displays selected marks.	All On/Individual Types of selectable marks Symbol: ○, △, □, ◇, × Area: Polygon, Circle, Ellipse, Fan Line: Solid Line, Dotted Line, Dashed Line, Circle, Ellipse, Arc, Arrow Text: Text
Area Fill (Fill)	Set the fill color display to On/Off. Check the On mark.	Off/On
Symbol/Simple Line Color (Symbol and Simple Line Color)	Set to On/Off the display of the color that targets the symbol and simple line. Check the color that is to be set to On.	Off/On
Mark Size (Mark size)	Set the mark display size.	1 (Minimum) /2/3/4/5 (Maximum)
Comment Font Size (Comment font size)	Set the font size of the comment.	Standard/Small

16.2.7 Setting up the display of Mariner's Mark/Line

When you select [Mariner's Mark/Line] in the classification pane, the [Mariner's Mark/Line] dialog is displayed in the edit pane.

Select mariner's marks and lines you want to display on the User Chart by selecting the corresponding check boxes.

You can select the following marks and lines.

- Clearing Line
- Tidal Stream
- Information Mark
- Highlighting
- Event Mark
- Plotted Position

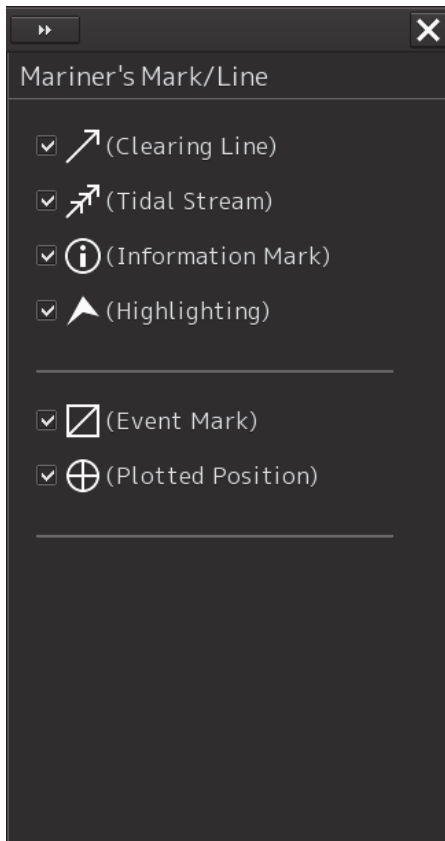

16.2.8 Setting up Radar Overlay and Transparency of Echo/Trails

When you select [RADAR] in the classification pane, the [RADAR] dialog is displayed in the edit pane.

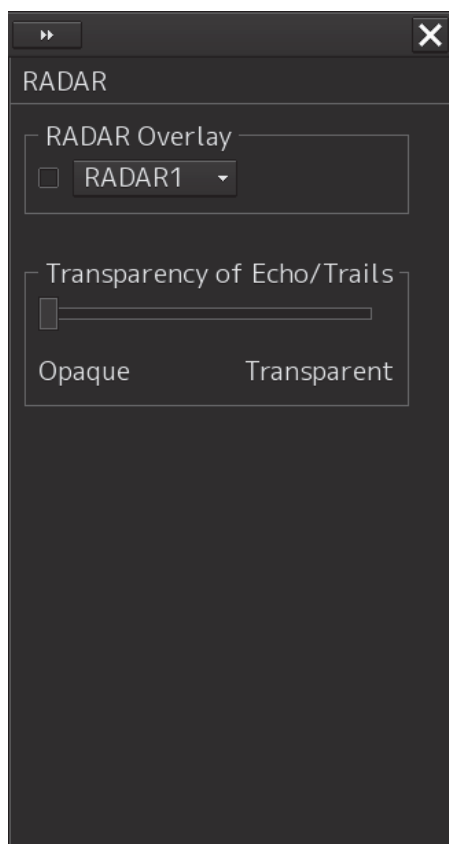

16

The descriptions of settings are shown in the table below.

Setting Item	Description of Setting	Setting Value
RADAR Overlay	<p>The radar overlay display turns ON by selecting the [RADAR Overlay]</p> <p>Select the required radar system from the pull-down menu.</p> <p>Note</p> <ul style="list-style-type: none"> - When this is turned OFF, even the alerts related to the radar will not be displayed. - This item is displayed on the ECDIS screen if RADAR interface is available. 	<p>Without interswitch setting RADAR1/RADAR2</p> <p>With interswitch setting RADAR1 to 8</p>
Transparency of Echo/Trails	<p>Click on the control on the slider and set up the transparency of echoes/trails.</p>	<p>0 to 15</p> <p>0 = Opaque (Nontransparent)</p> <p>15 = Transparent (Completely transparent)</p>

16.2.9 Setting up the display of TT/AIS Target

When you select [Target] in the classification pane, the [Target] dialog is displayed in the edit pane. Configure the settings for TT/AIS targets.

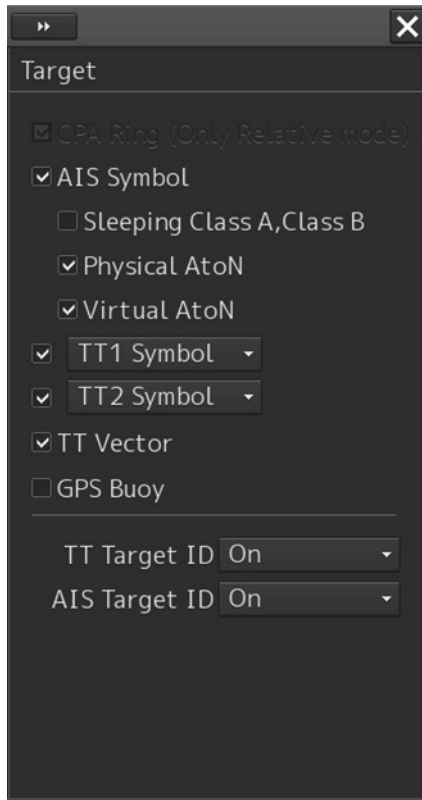

ECDIS screen

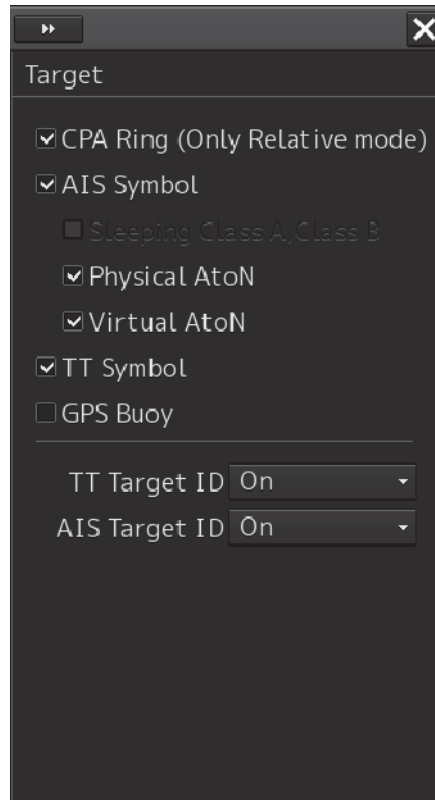



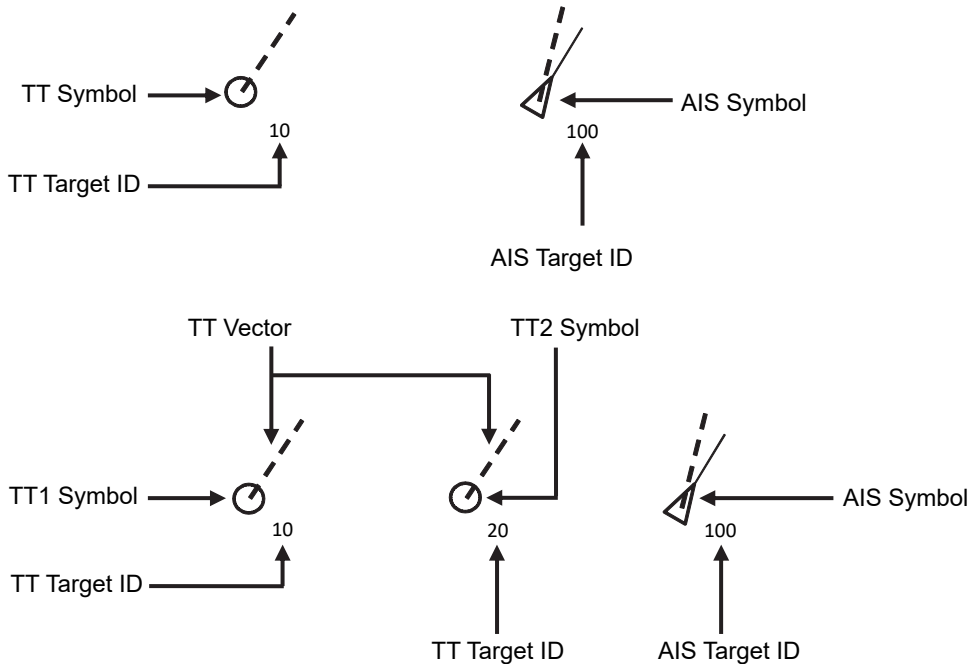





RADAR screen



The descriptions of settings are shown in the table below.

Setting Item	Description of Setting	Setting Value
AIS Symbol	Selecting this enables to display the AIS symbol.	To enable: Select. To disable: Clear.
Sleeping Class A, Class B	Selecting this enables to display the sleeping AIS of class A, ClassB.	To enable: Select. To disable: Clear.
Physical AtoN	Selecting this enables to display the Physical AIS AtoN when the AIS Symbol is selected.	To enable: Select. To disable: Clear.
Virtual AtoN	Selecting this enables to display the Virtual AIS AtoN when the AIS Symbol is selected.	To enable: Select. To disable: Clear.
TT Symbol	<p>Select this item to enable the TT symbol. Select the TT Symbol to be used from the combo box.</p> <p>TT1 Symbol TT2 Symbol</p> <p>TT1 Symbol indicates the TT target information that is received from RADAR1 and the TT Target ID is displayed as "T1-***" (** indicates the target number or ship name).</p> <p>TT2 Symbol indicates the TT target information that is received from RADAR2 and the TT Target ID is displayed as "T2-***" (** indicates the target number or ship name).</p> <p>Note This item is only enabled on the RADAR screen.</p>	To enable: Select. To disable: Clear.
TT Vector	<p>Selecting this enables to display the TT vector.</p> <p>Note This item takes effect only on the ECDIS screen.</p>	To enable: Select. To disable: Clear.
GPS Buoy	Selecting this enables to display the GPS Buoy symbol.	To enable: Select. To disable: Clear.

Setting Item	Description of Setting	Setting Value
TT Target ID	<p>Select a display mode of the TT target ID from the combo box.</p> <p>Off: Hide On: Show</p> <p>TT Track: Displays only the target that shows other ship's track.</p> <p>Display</p> <p>Ship's Name: When the ship's name has been input in the [TT Target INFO] (property of tracked target) dialog, that ship name is displayed. If the ship's name has not been input, the identification number is displayed.</p> <p>Display</p> <p> : Off</p> <p> : On</p> <p> : TT Track</p> <p> : Ship's Name</p>	Off, On, TT Track
AIS Target ID	<p>Select a display mode of the AIS target ID from the combo box.</p> <p>Off: Hide On: Show</p> <p>AIS Track: Displays only the target that shows other ship's track (target track).</p> <p>Ship's Name: When the ship's name has been input in the [AIS Target INFO] (property of AIS target) dialog, that ship name is displayed. If the ship's name has not been input, the identification number is displayed.</p> <p>Display</p> <p> : Off</p> <p> : On</p> <p> : TT Track</p> <p> : Ship's Name</p>	Off, On, AIS Track, Ship's Name

16.2.10 Setting up the display of Other Ship's Track

When you select [Target Track] in the classification pane, the [Target Track] dialog is displayed in the edit pane.

The [Target Track] dialog consists of the [Display], [Plot] and [Clear] tabs.

[Display] tab

On the [Display] tab, set up the display of other ship's tracks.

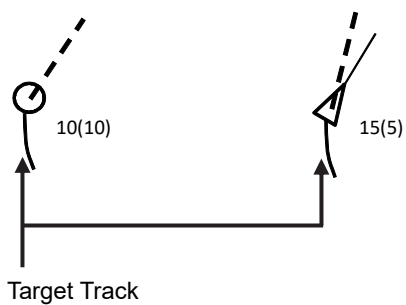
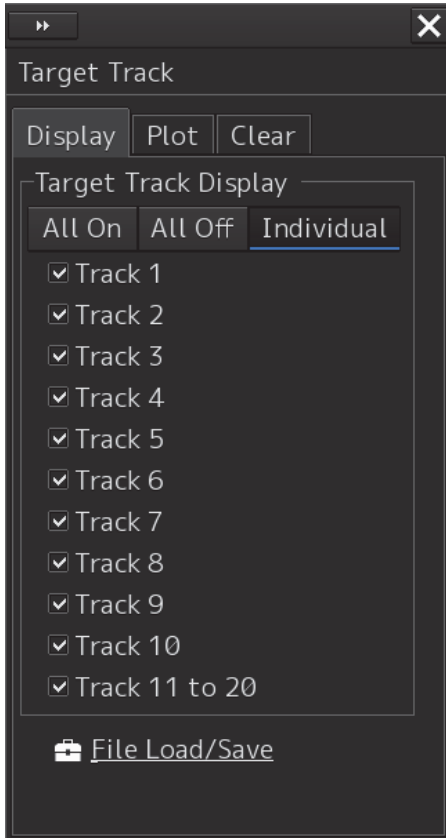

The descriptions of settings are shown in the table below.

Setting Item	Description of Setting	Setting Value
Target Track Display (display of other ship's tracks)	Select to show/hide target tracks by clicking on the corresponding buttons and then specify the target tracks you want to display by checking them. All On: Shows all of target tracks. All Off: Hides all of target tracks. Individual: Shows selected target tracks.	All On, All Off When Individual is selected: Select from Tracks 1 to 10 and from Tracks 11 to 20.

Shortcut

Click on any of available shortcuts to display the related dialog box.

Shortcut	Setup Dialog Box
File Load/Save	[File Load/Save] dialog box in File Manager

[Plot] tab

The edit pane of the [Plot] tab is divided into two dialogs.

To advance to the next dialog: Click on the [Next] button.

To return to the previous dialog: Click on the [Back] button.

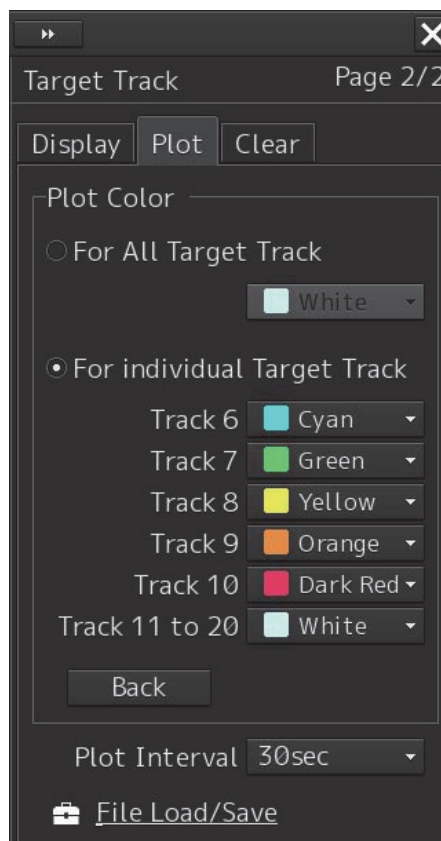
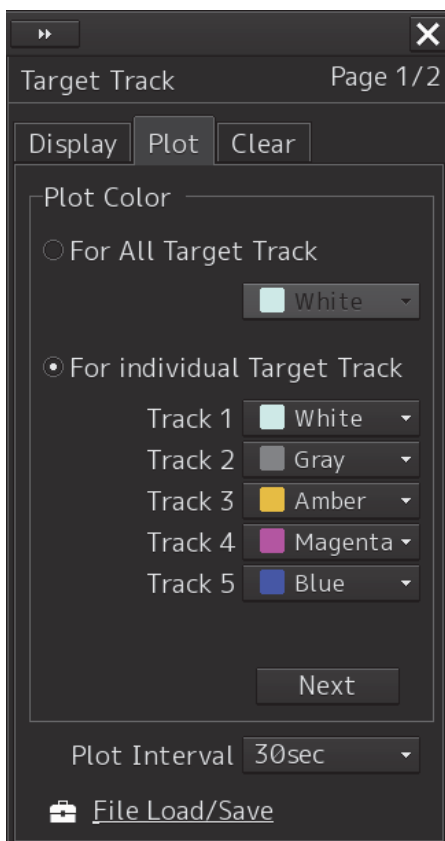

The descriptions of settings are shown in the table below.

Setting Item	Description of Setting	Setting Value
For All Target Track	Click on the check box and select a plot color of target tracks from the list.	White (Black), Gray, Amber, Magenta, Blue, Cyan, Green, Yellow, Orange and Dark Red
For Individual Target Track	Click on the check box and select plot colors of individual target tracks (Tracks 1 to 10 and Tracks 11 to 20) from the list.	White (Black), Gray, Amber, Magenta, Blue, Cyan, Green, Yellow, Orange and Dark Red
Plot Interval	Select a plot interval of target tracks from the combo box.	Off, 3s, 5s, 10s, 30s, 1 min, 3 min, 5 min, 10 min, 30 min, 60 min, 1 NM, 3 NM, 5 NM, 10 NM, 0.1 NM, 0.2 NM, 0.3 NM, 0.5 NM

* White/Black interchanges under the following conditions.

RADAR screen: Always White

ECDIS screen: Black at Day1/Day2 (or Day), white at Day3/Dusk/Night

Shortcut

Click on any of available shortcuts to display the related dialog box.

Shortcut	Setup Dialog Box
File Load/Save	[File Load/Save] dialog box in File Manager

[Clear] tab

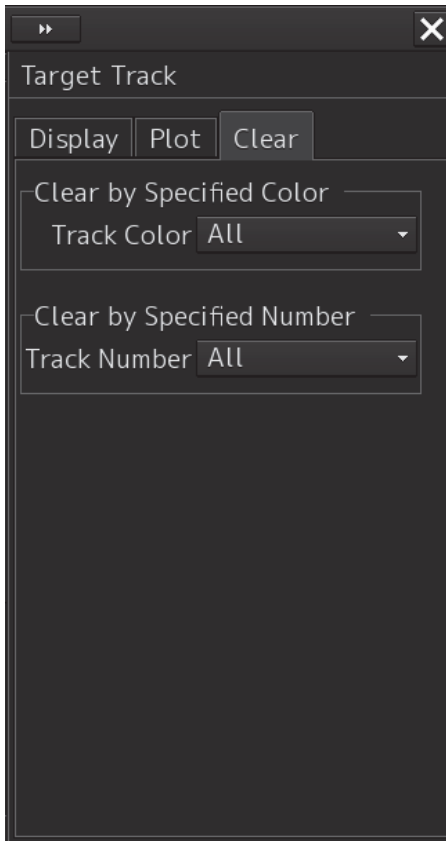

To erase tracks by specifying a color

- 1 Select the color of other ship's track to be erased from the [Track Color] combo box.**
You can select from All, White, Gray, Amber, Magenta, Blue, Cyan, Green, Yellow, Orange and Dark Red.
White/Black interchanges under the following conditions.
RADAR screen: Always White
ECDIS screen: Black at Day1/Day2 (or Day), white at Day3/Dusk/Night
A message dialog box prompting you to confirm erasing appears.

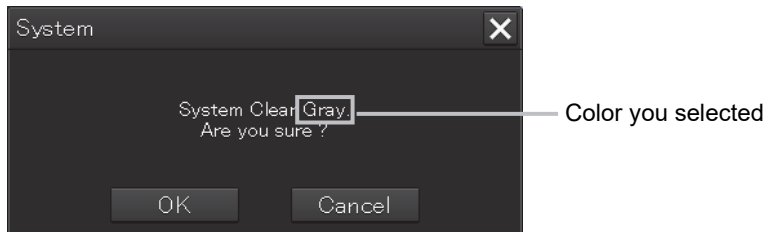

- 2 To execute erasing, click on the [OK] button. To cancel erasing, click on the [Cancel] button or the [X] button.**

Erasing by specifying a track number

- 1 Select the number of other ship's track to be erased from the [Track Number] combo box.

Options of the track to be erased include All, Track 1, Track 2, Track 3, Track 4, Track 5, Track 6, Track 7, Track 8, Track 9, Track 10, and Track 11 – 20.

An erase confirmation message dialog is displayed.

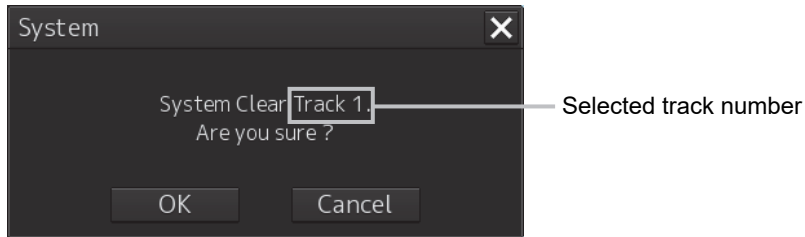

- 2 To execute erase, click the [OK] button. To cancel erase, click the [Cancel] button or the [x] button.

16.2.11 Setting up the display of Chart Common

When you select [Chart Common] in the classification pane, the [Chart Common] dialog is displayed in the edit pane.



The edit pane is divided into two dialogs.

To advance to the next dialog: Click on the [Next] button.

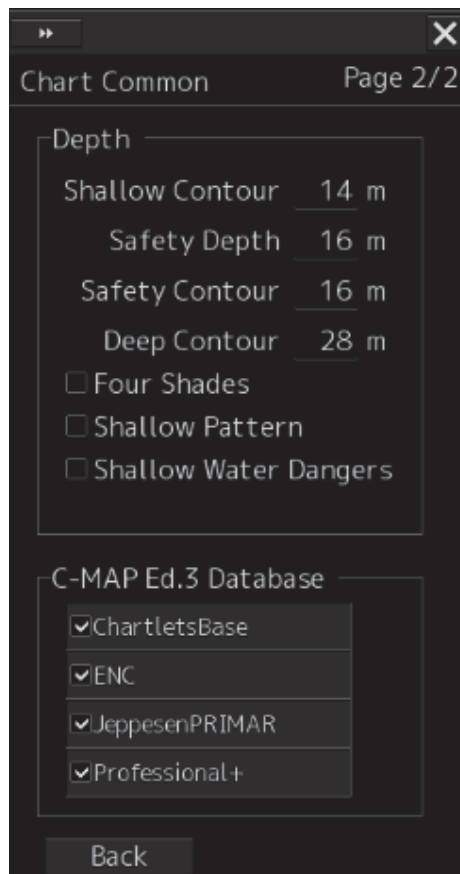
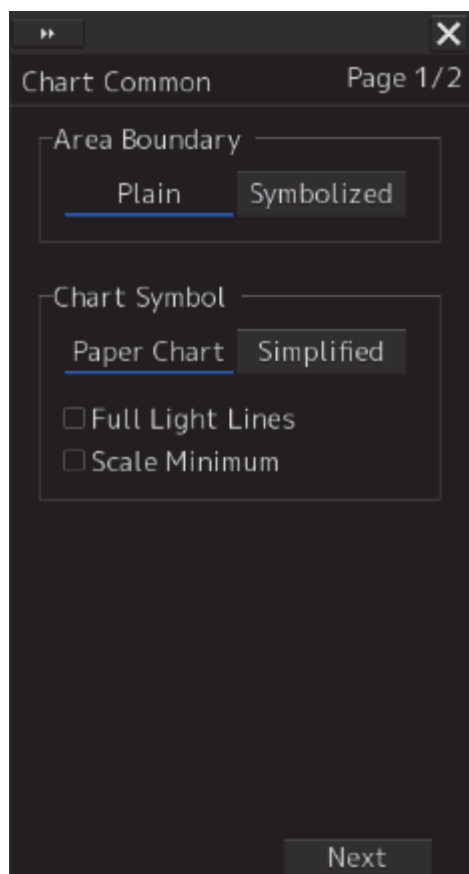
To return to the previous dialog: Click on the [Back] button.

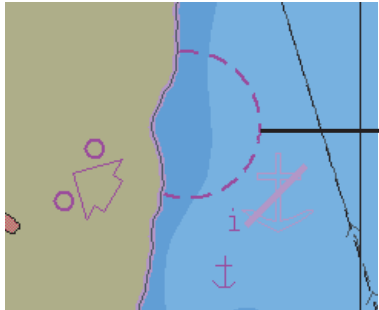
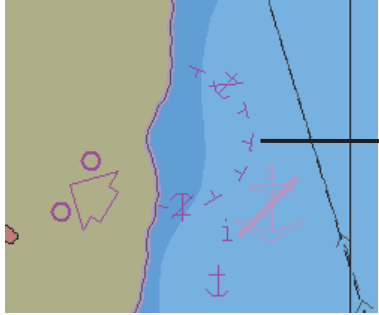
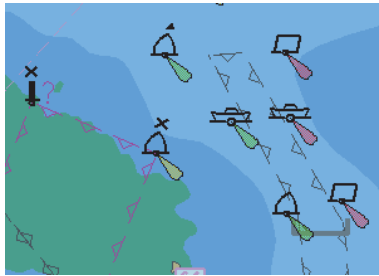
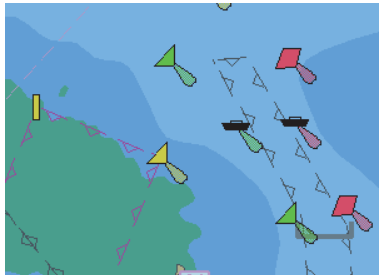

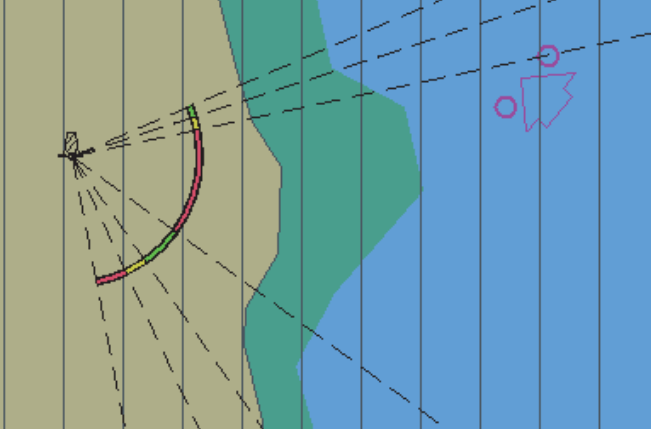
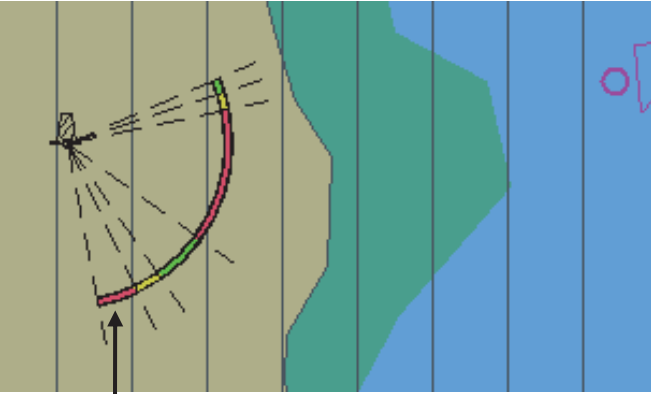
Setting Item	Description of Setting	Setting Value
<p>Area Boundary</p>	<p>Select a display method of area boundary by clicking on the corresponding button.</p> <p>Plane: Displays a plane boundary (an area boundary is indicated by dotted lines).</p>  <p>Symbolized: Displays a symbol boundary (an area boundary is indicated by symbol lines).</p> 	<p>Plane, Symbolized</p>
<p>Chart Symbol</p>	<p>Select a type of chart symbols you want to use on the chart by clicking on the corresponding button.</p> <p>Paper Chart: The same symbols on paper charts are used as symbols for lighthouses, etc.</p>  <p>Simplified: Colored symbols are displayed.</p> 	<p>Paper Chart, Simplified</p>

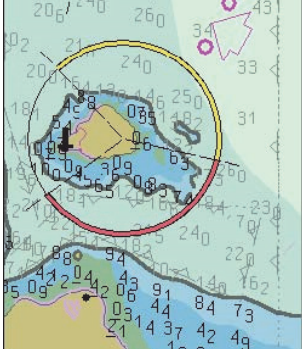
Setting Item	Description of Setting	Setting Value
Full Light Lines	<p>When selected, display of maximum length of full light lines are enabled.</p>  <p>When [Full Light Lines] are enabled</p>  <p>Light range of lighthouse</p> <p>When [Full Light Lines] are disabled.</p>	To enable: Select. To disable: Clear.
Scale Minimum	<p>When selected, scale display smaller than the minimum scale setting value is disabled.</p>  <p>When [Scale Minimum] is enabled</p>  <p>When [Scale Minimum] is disabled</p>	To enable: Select. To disable: Clear.

Setting Item	Description of Setting	Setting Value
Depth	Refer to "Depth."	
C-MAP Ed.3 Database	<p>Select this to show a chart database chart. *Only the imported chart databases can be selected.</p> <p>During manual updating of a chart, the C-MAP database list cannot be changed. Therefore, the following restrictions are imposed while the Manual Update tool bar is displayed by selecting [Chart] - [Manual Update] in the menu.</p> <ul style="list-style-type: none"> • Chart Type of [View1] / [View2] cannot be changed in the [View-Options] dialog. • The C-MAP Ed.3 Database check box cannot be changed. <p>The Manual Update tool bar is closed, the restrictions are released.</p>	Shown: Selected Hidden: Clear

Depth

Use [Depth] items to set up the depth.

Setting Item	Description of Setting	Setting Value
Shallow Contour	<p>The shallow contour displayed on the chart is displayed at the set depth.</p> <p>For the display example, refer to "(1) Example of displaying Shallow Contour/Safety Contour/Deep Contour."</p>	0 to 200
Safety Depth	The spot depth that is lower than the set value is highlighted for display.	0 to 200
Safety Contour	<p>The set depth value on the chart (or depth that is lower than the set value) is highlighted for display.</p> <p>In the sea area that is shallower than the set value, an alarm occurs.</p> <p>*If the safety contour appropriate to the set depth is not provided on the chart, the safety contour that is deeper than the set value is displayed.</p> <p>For the display example, refer to "(1) Example of displaying Shallow Contour/Safety Contour/Deep Contour."</p>	0 to 200 *1
Deep Contour	<p>The deep contour displayed on the chart is displayed at the set depth.</p> <p>For the display example, refer to "(1) Example of displaying Shallow Contour/Safety Contour/Deep Contour."</p>	0 to 200 *1
Four Shades (Sea area four-color display)	<p>Normally, the sea is displayed on the chart by four colors at each depth. When [Four Shades] is disabled, the sea is displayed by two colors with [Safety Contour] as a boundary.</p> <p>This item is set to clearly separate the sea into the safe area and the area where navigation requires caution.</p> <p>For the display example, refer to "(2) Example of Displaying Four Shades."</p>	To enable: Select. To disable: Clear.

Setting Item	Description of Setting	Setting Value
Shallow Pattern	Of depth that can be set at 4 levels, a lattice-like line is added to the shallow sea set in [Shallow Contour] and [Safety Contour]. This item is set to display the area where navigation requires caution conspicuously. For the display example, refer to "(3) Example of Displaying Shallow Pattern."	To enable: Select. To disable: Clear.
Shallow Water Dangers (Isolated obstacles in shallow water)	A dangerous route obstacle existing in the sea area that is shallower than safety contour is displayed by  mark. For the display example, refer to "(4) Example of displaying Shallow Water Dangers."	To enable: Select. To disable: Clear.

*1: The MIN Safety Contour (Minimum value of Safety Contour that can be set) of the Own ship's parameters is used as the minimum value of the Safety Contour. For details about how to set the Own ship's parameters, refer to "19.3.4 Setting own ship's parameters".

(1) Example of displaying Shallow Contour/Safety Contour/Deep Contour

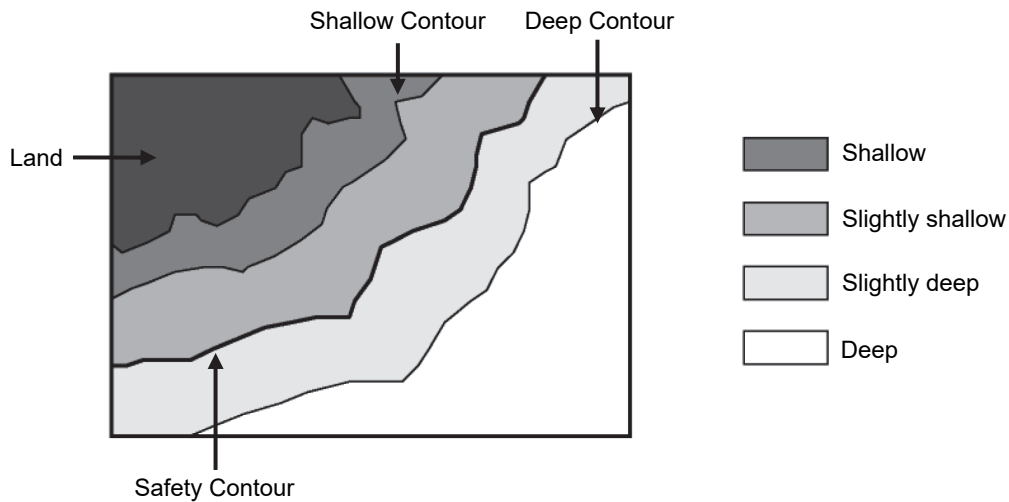

(2) Example of displaying Four Shades

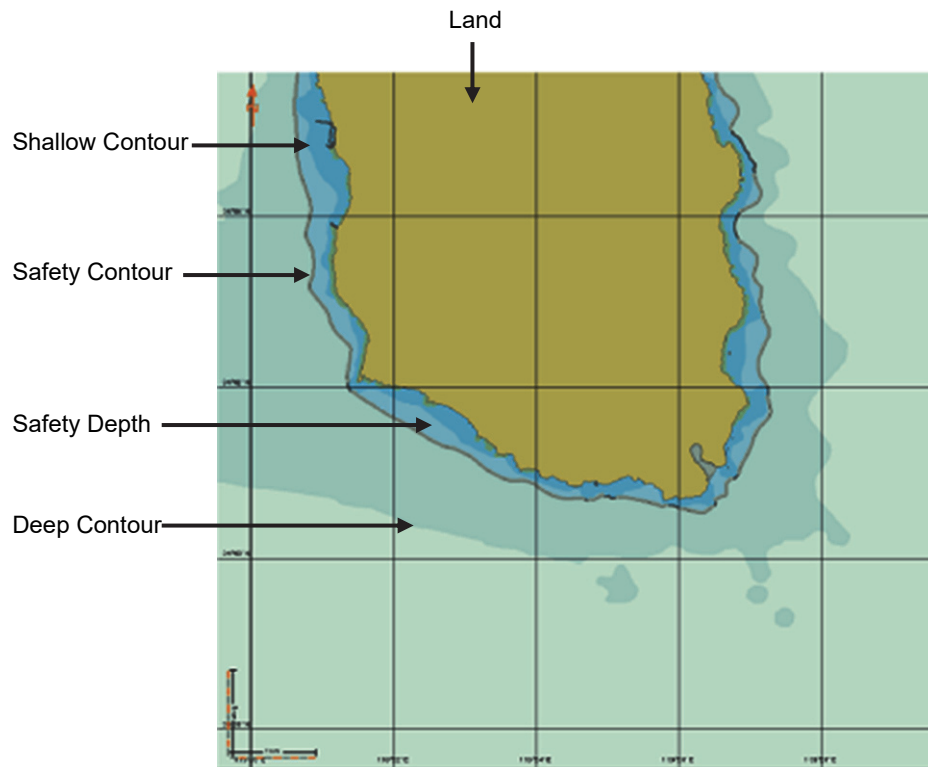

When [Four Shades] is enabled (the sea area is displayed by four colors.)

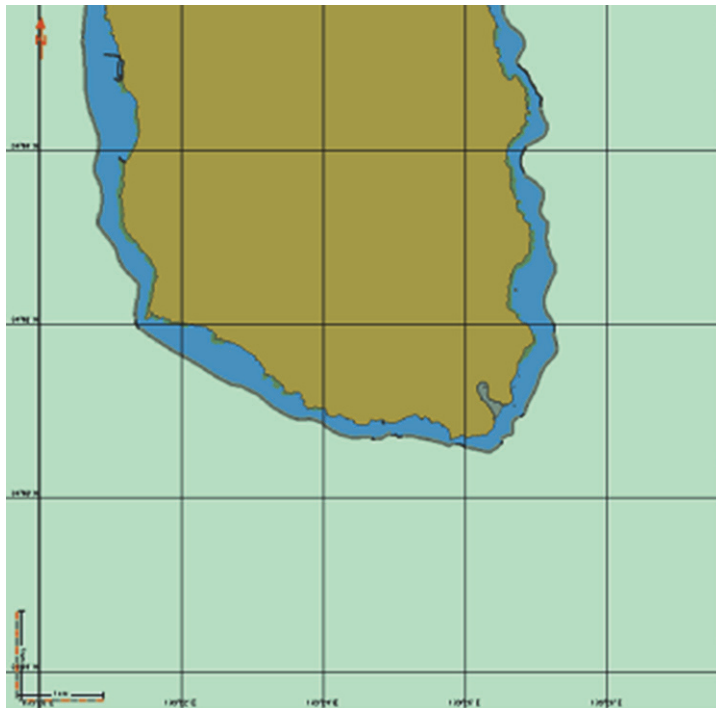

When [Four Shades] is disabled (the sea area is displayed by two colors.)

(3) Example of displaying Shallow Pattern

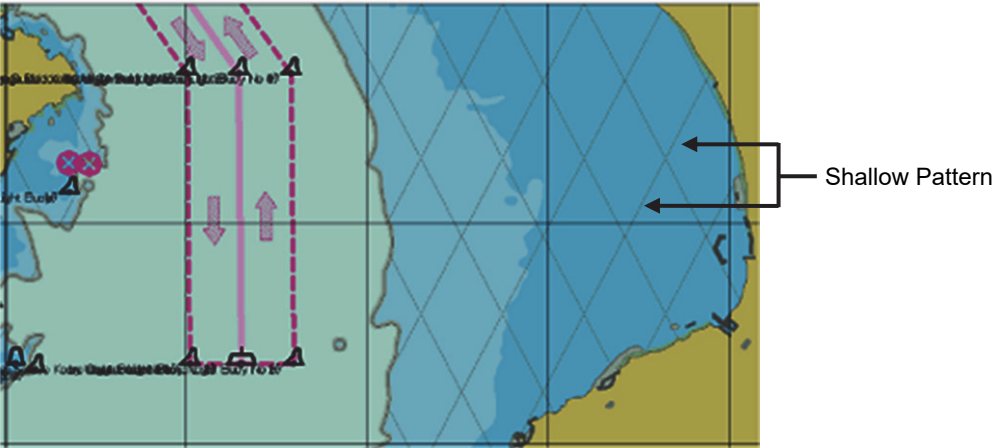

When [Shallow Pattern] is enabled (the shallow pattern is displayed)

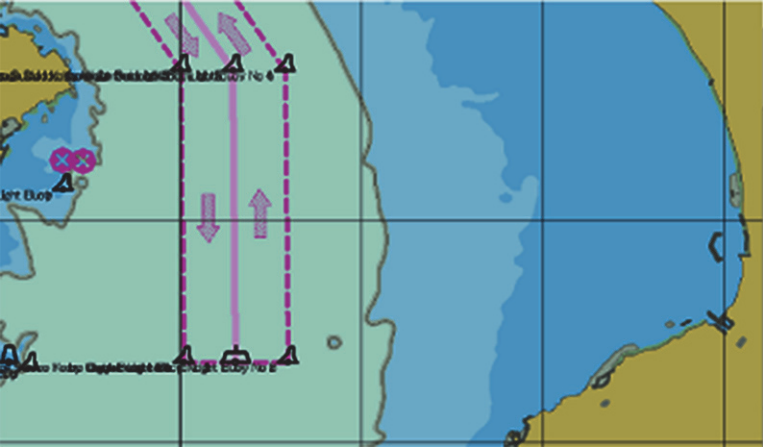

When [Shallow Pattern] is disabled (the shallow pattern is not displayed)

(4) Example of displaying Shallow Water Dangers

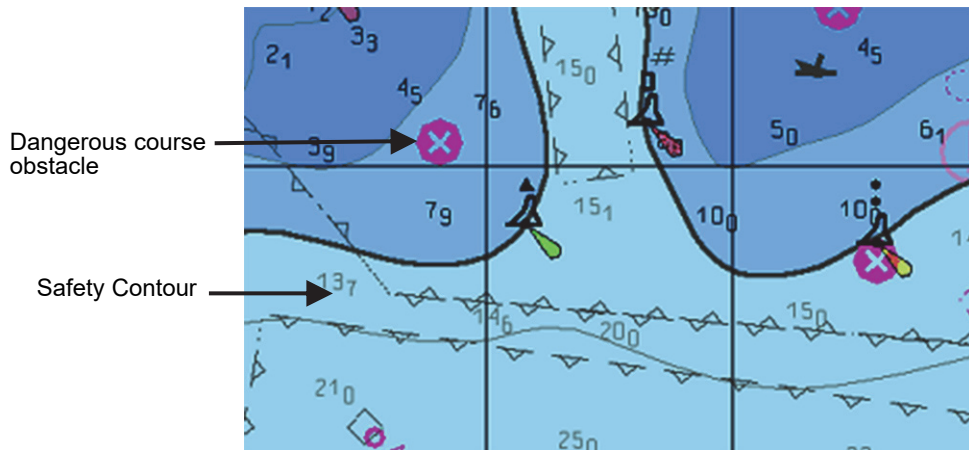

When Shallow Water Dangers is enabled

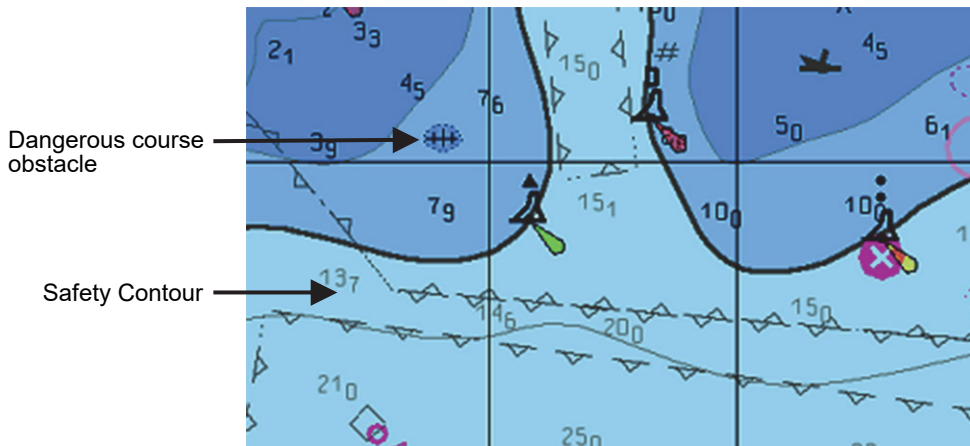

When Shallow Water Dangers is disabled

Restrictions on [Safety Contour] and [Deep Contour]

1) When entering in [Shallow Contour]

If “Safety Contour < Shallow Contour ≤ Deep Contour”, the Safety Contour value is corrected to the Shallow Contour value.

If “Safety Depth < Shallow Contour ≤ Deep Contour”, the Safety Contour is corrected to the Shallow Contour value.

If Safety Contour, Safety Depth ≤ Deep Contour < Shallow Contour”, the Safety Contour, Safety Depth, and Deep Contour values are corrected to the Shallow Contour value.

2) When entering in [Deep Contour]

If “Shallow Contour ≤ Deep Contour < Safety Contour”, the Safety Contour value is corrected to the Deep Contour value.

If “Shallow Contour ≤ Deep Contour < Safety Depth”, the Safety Depth value is corrected to the Deep Contour value.

If “Deep Contour < Shallow Contour ≤ Safety Contour, Safety Depth”, the Safety Contour, Safety Depth, and Shallow Contour values are corrected to the Deep Contour values.

3) When entering in [Safety Contour]

If “Shallow Contour ≤ Deep Contour < Safety Contour”, the Deep Contour value is corrected to the Safety Contour value.

If “Safety Contour < Shallow Contour ≤ Deep Contour”, the Shallow Contour value is corrected to the Safety Contour value.

4) When entering [Safety Depth]

If “Shallow Contour ≤ Deep Contour < Safety Depth”, the Deep Contour value is corrected to the Safety Depth value.

If “Safety Depth < Shallow Contour ≤ Deep Contour”, the Shallow Contour value is corrected to the Safety Depth value.

The compensated setting values are flashed temporarily.

16.2.12 Setting up the display of RADAR Chart

When you select [Chart Display] in the classification pane, the [Chart Display] dialog is displayed in the edit pane.

The edit pane is divided into two dialogs.

To advance to the next dialog: Click on the [Next] button.

To return to the previous dialog: Click on the [Back] button.

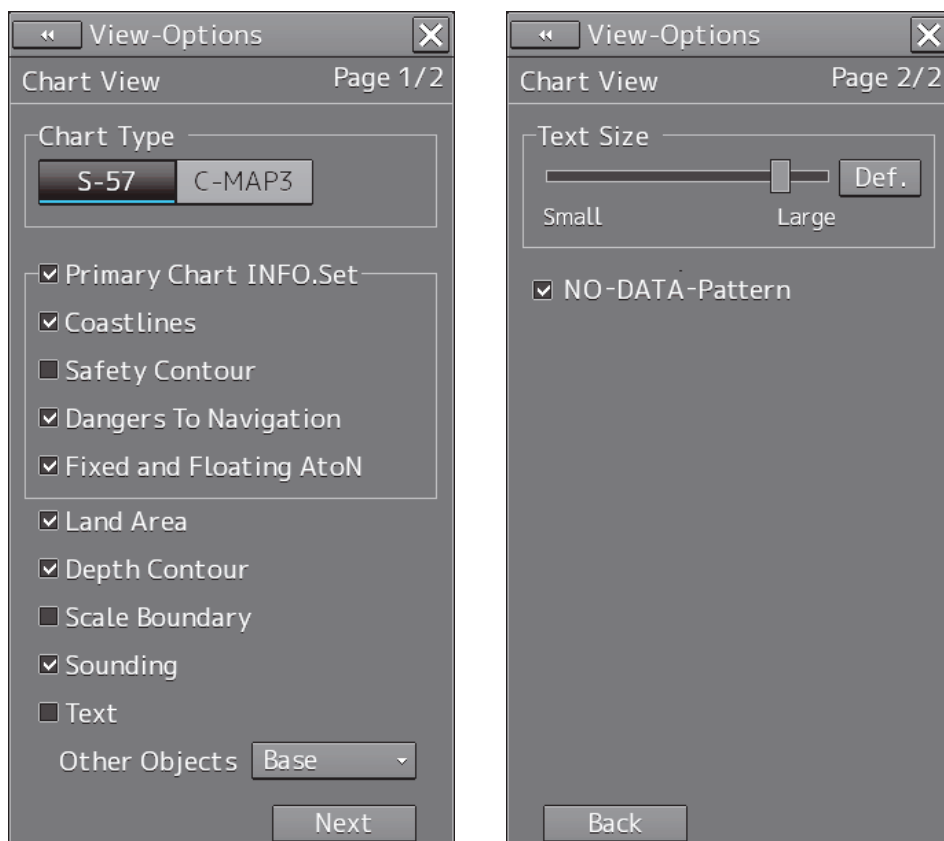

The chart information uses the same reference and display mode as the radar / AIS, including CCRP, geodetic datum, display scale, motion mode, and bearing mode.

The descriptions of settings are shown in the table below.

Setting Item	Description of Setting	Setting Value
Chart Type	Select a type of charts to be displayed by click on the corresponding button. S-57: Shows S-57 charts. C-Map 3: Shows C-Map Ed3 charts.	S-57/C-Map 3
Text Size	Drag the control on the slider and set up the text size (7 levels). Clicking on the [Def.] (factory presetting) button resets the current value to the default value.	0 to 6
Primary Chart INFO. Set* ¹	Select to enable to show Primary Chart INFO. Set, and then select the items you want to display.	To enable: Select. To disable: Clear. Display items Coastline, Safety Contour, Dangers To Navigation, Fixed and Floating Aids to Navigation
Land Area	Selecting this enables to display land areas.	To enable: Select. To disable: Clear.
Depth Contour	Selecting this enables to display depth contours.	To enable: Select. To disable: Clear.
Scale Boundary	Selecting this enables the display of scale boundary.	To enable: Select. To disable: Clear.
Sounding	Selecting this enables the display of sounding.	To enable: Select. To disable: Clear.
Text	Selecting this enables to display text.	To enable: Select. To disable: Clear.
Other Objects	Select a display method of objects other than land, depth contour and text from the combo box. Off: Hides other objects. Base: Shows objects other than the above which are included in the display category [Base]. Standard: Shows objects other than the above which are included in the display category [Standard].	Off/Base, Standard

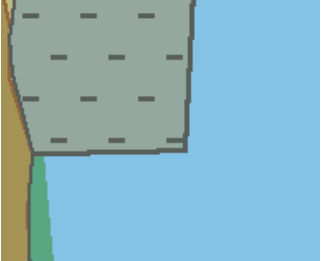
Setting Item	Description of Setting	Setting Value
NO-DATA-Pattern	<p>Selecting this enables to display NO-DATA-Pattern.</p> <p>NO-DATA-Pattern is the display pattern of the area that does not have chart data.</p> <p>(Example)</p>  <p>When display of NO-DATA-Pattern is disabled, the RADAR screen is displayed in the background.</p>	<p>To enable: Select.</p> <p>To disable: Clear.</p>

*1 The primary chart information set is chart features and symbols defined in source documents of IMO Resolution A.817(19) and IEC 61174.

16.2.13 Setting up the display of ECDIS Chart

When you select [Chart View] in the classification pane, the [Chart View] dialog is displayed in the edit pane.

The edit pane is divided into three dialogs.

To advance to the next dialog: Click on the [Next] button.

To return to the previous dialog: Click on the [Back] button.

You can set up the same values on both the [View1] and [View2] tabs.

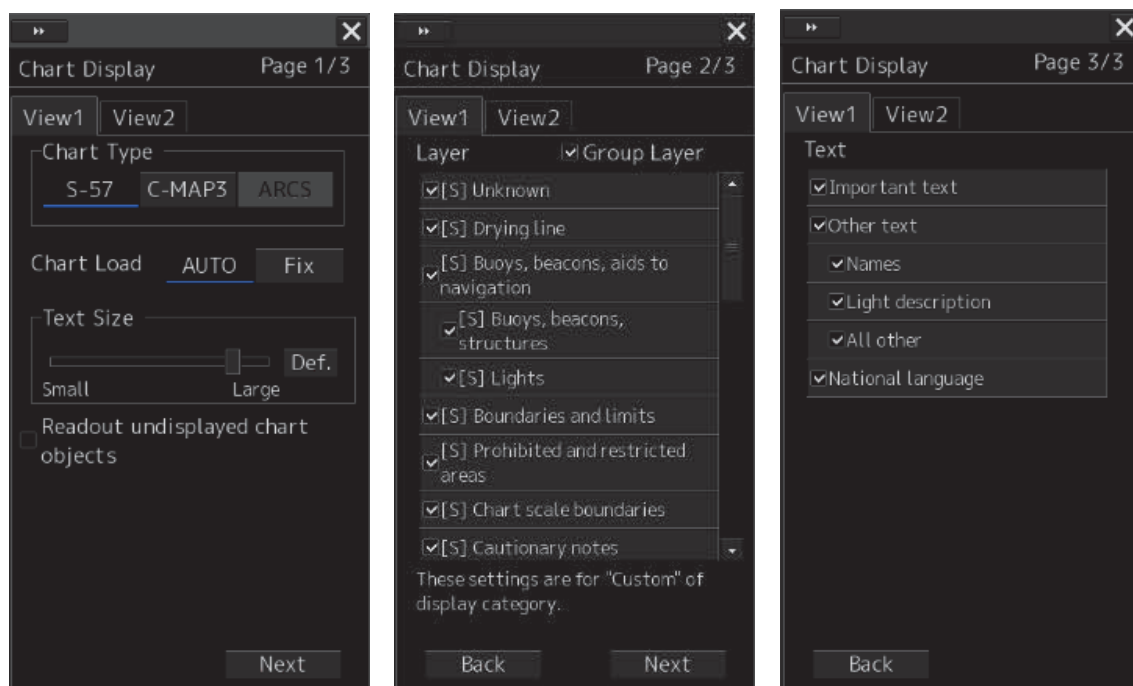

By setting the [Readout undisplayed chart objects] check box to ON or OFF in Page 1/3, it is possible to select whether the object without Viewing Group setting is displayed on the pick report.

When the check box is checked, the object is displayed.

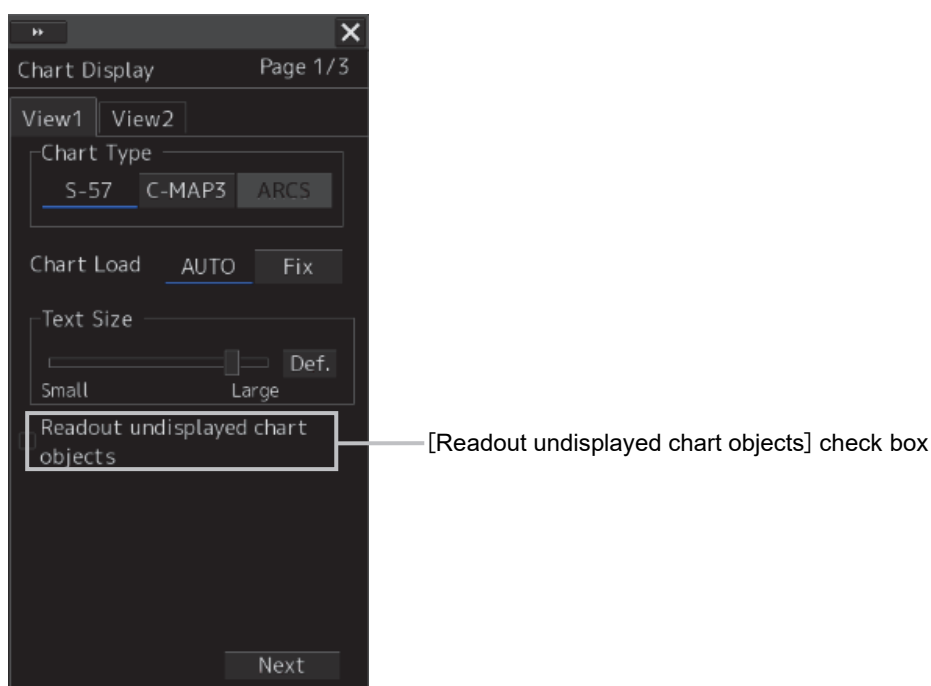

Setting a Group Layer

When the [Group Layer] check box is set to ON in Page 2/3, the Viewing Layers are grouped. The grouped lists are displayed under the main-sub layers.

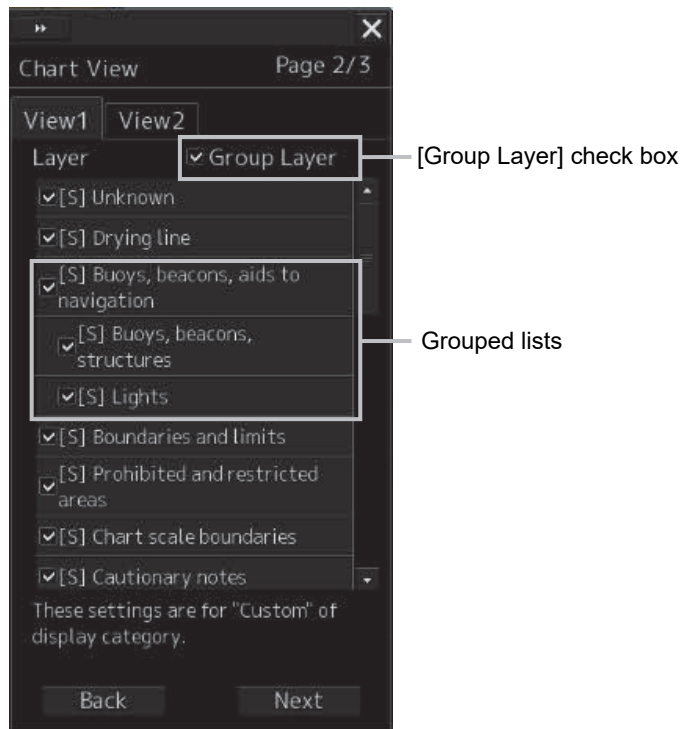

The descriptions of settings are shown in the table below.

Setting Item	Description of Setting	Setting Value
Chart Type	Select a type of charts to be displayed by clicking on the corresponding button. S-57: Shows S-57 charts. C-Map 3: Shows C-Map Ed3 charts. ARCS: Shows ARCS charts.	S-57, C-Map 3, ARCS
Text Size	Drag the control on the slider and set up the text size (7 levels). Clicking on the [Def.] (Factory settings) button resets the text size to the factory preset value. For the details of the examples of changing text size, refer to "Example of changing text size".	0 to 6
Chart Load	Select a display switching mode for the S-57 chart by clicking on the button. [AUTO]: Automatically switches and shows charts. [Fix]: Fixes and shows the chart being currently displayed.	AUTO, Fix
Layer	When showing S-57/C-MAP charts, select the objects you want to display by selecting the check boxes of desired objects.	Refer to "Contents to be displayed as layers".
Text	When showing S-57/C-MAP charts, select the texts you want to display by selecting the check boxes of desired texts.	Refer to "Contents to be displayed as texts".

Example of changing text size

Standard



↓ Small ↑ Large

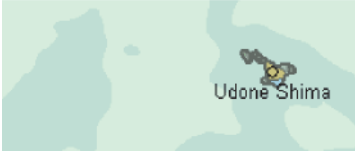

↓ Small ↑ Large



↓ Small ↑ Large



↓ Large ↑ Small



↓ Large ↑ Small



← Large
→ Small

Contents to be displayed as layers

Set up the items to be displayed when the chart display category is [Custom].

There are three types of layers: [-], [S] and [A].

[-]: Items whose display categories are none of [BASE], [STD(Standard)] nor [All].

[S]: Items to be displayed when the display category is [STD].

[A]: Items to be displayed when the display category is [All].

The items that are displayed vary according to the setting of Group Layer to ON or OFF.

Type	ENC Layer (Group Layer OFF)
[S]	Unknown
	Generic Object
	Chart scale boundary, overscale data
	Land region, Sea area/named water area
	Lake, Sloping ground, Slope top, Causeway, Dam, Dyke
	Radar/Visually conspicuous object, Built up area
	Swept area
	Sand wave, Tunnel on seabed, Mooring cables
	Navigation line
	Recommended track/traffic lane/route centreline
	Ferry route
	RADAR line , Limit of shore radar, Radio calling in point
	Restricted area
	Submarine transit lane, Military practice area, Sea plane landing area, Offshore production area
	Fairway
	Caution area
	Fishing ground, Marine farm
	Anchorage area, Anchor berth
	Dumping ground, Cargo transshipment area, Incineration area
	Archipelagic sea lane
	Buoy, Beacon, Light float, Mooring buoy, Light Vessel
	Daymark
	Distance mark
	Navigational system mark
	topmarks
	Gridiron
	light
Fog signal, Retro-reflector, Radar transponder beacon, Radar reflector	
Pilot boarding place, Signal station, Traffic, Signal station, Warning	

Type	ENC Layer (Group Layer OFF)
[A]	Accuracy
	Nautical publication
	Highlight info
	Highlight document
	Highlight date dependent
	Coverage, Compilation scale of data
	Local magnetic anomaly, Magnetic variation
	Dunes, Hills, Ridge, Clifftop, Contours and elevation
	Vegetation, Lake, Rapids, River, Water fall, Tideway
	Building, Fortified structure, Land mark, Silo/Tank, Airport, Road, Railway
	Check point, Harbor facility
	Berth, Crane, Drydock, Mooring facility, Gate
	Spot Sounding
	Depth contours
	Contour label
	Water turbulence
	Tide..., Current-non-gravitational
	Seabed area, Weed/Kelp, Spring
	Cable area, Pipeline area
	Obstruction, Wreck, Underwater/Awash rock
	Submarine cable/pipeline
	Continental shelf area
	Custom zone, Free port area, Harbour area
	Fishery zone
	Administration area, Contiguous zone, Exclusive economic zone
	Radar station, Radio station, Coastguard station, Rescue station
	Chart boundary
ENC edition date	
most recent chart update number	
Grid	
[-]	Updated Review

Type	C-MAP Ed.3 Layer (Group Layer OFF)
[S]	Unknown
	Generic Object
	Chart scale boundary, overscale data
	Land region, Sea area/named water area
	Lake, Sloping ground, Slope top, Causeway, Dam, Dyke
	Radar/Visually conspicuous object, Built up area
	Swept area
	Sand wave, Tunnel on seabed, Mooring cables
	Navigation line
	Recommended track/traffic lane/route centreline
	Ferry route
	RADAR line , Limit of shore radar, Radio calling in point
	Restricted area
	Submarine transit lane, Military practice area, Sea plane landing area, Offshore production area
	Fairway
	Caution area
	Fishing ground, Marine farm
	Anchorage area, Anchor berth
	Dumping ground, Cargo transshipment area, Incineration area
	Archipelagic sea lane
	Buoy, Beacon, Light float, Mooring buoy, Light Vessel
	Daymark
	Distance mark
	Navigational system mark
	topmarks
	Gridiron
	light
	Fog signal, Retro-reflector, Radar transponder beacon, Radar reflector
Pilot boarding place, Signal station, Traffic, Signal station, Warning	

Type	C-MAP Ed.3 Layer (Group Layer OFF)
[A]	Accuracy
	Nautical publication
	Highlight info
	Highlight document
	Highlight date dependent
	Coverage, Compilation scale of data
	Local magnetic anomaly, Magnetic variation
	Dunes, Hills, Ridge, Clifftop, Contours and elevation
	Vegetation, Lake, Rapids, River, Water fall, Tideway
	Building, Fortified structure, Land mark, Silo/Tank, Airport, Road, Railway
	Check point, Harbor facility
	Berth, Crane, Drydock, Mooring facility, Gate
	Spot Sounding
	Depth contours
	Contour label
	Water turbulence
	Tide..., Current-non-gravitational
	Seabed area, Weed/Kelp, Spring
	Cable area, Pipeline area
	Obstruction, Wreck, Underwater/Awash rock
	Submarine cable/pipeline
	Continental shelf area
	Custom zone, Free port area, Harbor area
Fishery zone	
Administration area, Contiguous zone, Exclusive economic zone	
Radar station, Radio station, Coastguard station, Rescue station	
Grid	
[-]	Update Review

Type	ENC Layer (Group Layer ON)
[S]	Unknown
	Drying line
	Buoys, beacons, aids to navigation
	Buoys, beacons, structures
	Lights
	Boundaries and limits
	Prohibited and restricted areas
	Chart scale boundaries
	Cautionary notes
	Ships' routing ¹ systems and ferry routes
	Archipelagic sea lanes
	Miscellaneous

¹ routing: UK notation

Type	ENC Layer (Group Layer ON)
[A]	Accuracy
	Highlight date dependent
	Highlight info
	Highlight document
	Contour label
	Spot soundings
	Submarine cables and pipelines
	All isolated dangers
	Magnetic variation
	Depth contours
	Seabed
	Tidal
	Miscellaneous
	Chart boundary
	ENC edition date
most recent chart update number	
Grid	
[-]	Update Review

Type	C-MAP Ed.3 Layer (Group Layer ON)
[S]	Unknown
	Drying line
	Buoys, beacons, aids to navigation
	Buoys, beacons, structures
	Boundaries and limits
	Prohibited and restricted areas
	Chart scale boundaries
	Cautionary notes
	Ships' routing ² systems and ferry routes
	Archipelagic sea lanes
	Miscellaneous

² routing: UK notation

Type	C-MAP Ed.3 Layer (Group Layer ON)
[A]	Accuracy
	Highlight date dependent
	Highlight info
	Highlight document
	Contour label
	Spot soundings
	Submarine cables and pipelines
	All isolated dangers
	Magnetic variation
	Depth contours
	Seabed
	Tidal
	Miscellaneous
Grid	
[-]	Update Review

Contents to be displayed as texts

ENC Text (Group Layer OFF)
Important text (Vertical Clearance bridge, overhead cable, so on)
Name/Number of: buoys, beacons, so on
Light description
Note on chart data or nautical publication
Nature of seabed
Geographic names
Value of: magnetic variation, swept depth
Height of islet or land feature
Berth number
Current velocity
National language

C-MAP Ed.3 Text (Group Layer OFF)
Important text(Vertical Clearance bridge, overhead cable, so on)
Name/Number of: buoys, beacons, so on
Light description
Note on chart data or nautical publication
Nature of seabed
Geographic names
Value of: magnetic variation, swept depth
Height of islet or land feature
Berth number
Current velocity
National language

ENC Text (Group Layer ON)
Important text
Other text
Names
Light description
All other
National language

C-MAP Ed.3 Text (Group Layer ON)
Important text
Other text
Names
Light description
All other
National language

16.2.14 Setting up AIO/T&P display

When you select [AIO/T&P] in the classification pane, the [AIO/T&P] dialog box appears in the edit pane.

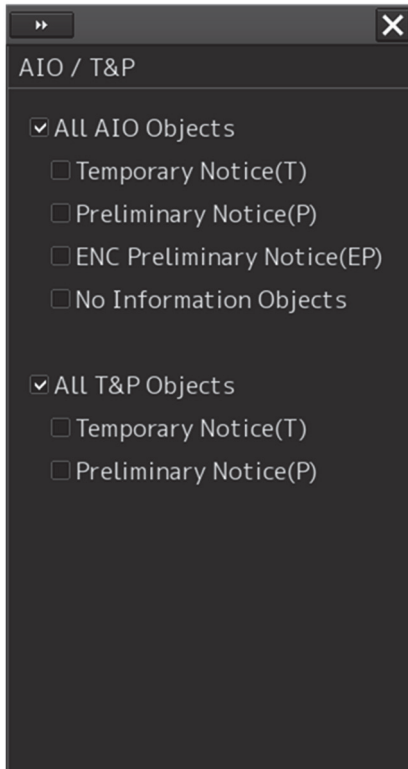

The descriptions of settings are shown in the table below.

Setting Item	Description of Setting	Setting Value
All AIO Objects	Select and enable the display of all AIO objects.	To enable: Select. To disable: Clear.
Temporary Notice (T)	Select and enable the display associated with Temporary Notice (T).	To enable: Select. To disable: Clear.
Preliminary Notice (P)	Select and enable the display associated with Preliminary Notice (P).	To enable: Select. To disable: Clear.
ENC Preliminary Notice (EP)	Select and enable the display associated with ENC Preliminary Notice (EP).	To enable: Select. To disable: Clear.
No Information Objects	Select and enable the display associated with No Information Objects.	To enable: Select. To disable: Clear.
All T&P Objects	Select and enable the display of all T&P objects	To enable: Select. To disable: Clear.
Temporary Notice (T)	Select and enable the display associated with Temporary Notice (T).	To enable: Select. To disable: Clear.
Preliminary Notice (P)	Select and enable the display associated with Preliminary Notice (P).	To enable: Select. To disable: Clear.

Note

T&P will not be displayed if the display scale is a small scale of more than 1 / 20,000,000.

16.2.15 Set display of danger detection highlight

When you select [Graphical Indication] in the classification pane, the [Graphical Indication] dialog box appears in the edit pane.

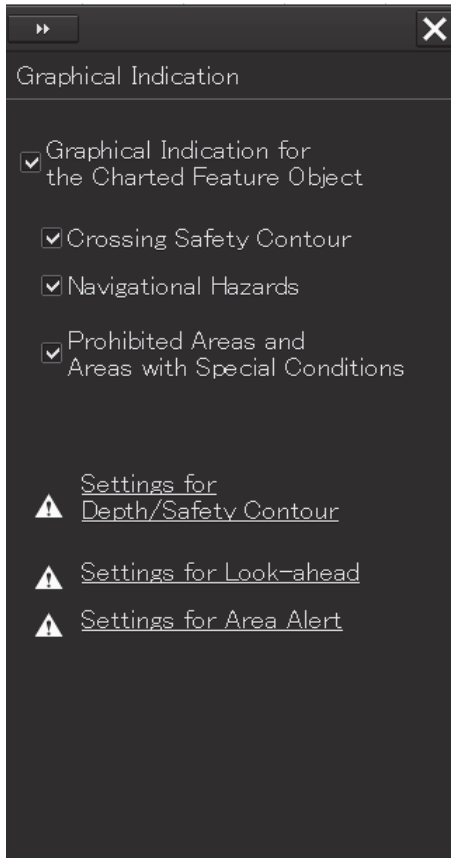

The descriptions of settings are shown in the table below.

Setting Item	Description of Setting	Setting Value
Graphical Indication for the Charted Feature object	Select and enable the highlighting function of the detection object on the chart	To enable: Select. To disable: Clear.
Crossing Safety Contour	Activate the partial highlight display function of the object where the execution result of Safety Check becomes Crossing Safety Contour error.	To enable: Select. To disable: Clear.
Navigational Hazards	Activate the partial highlight display function of the object where the execution result of Safety Check becomes Navigational Hazards error.	To enable: Select. To disable: Clear.
Prohibited Areas and Areas with Special Conditions	Prohibited Area or Areas with Special Condition activates the partial highlighting function of the error part.	To enable: Select. To disable: Clear.
Settings for Depth/Safety Contour	Click to open the Depth / Safety Contour screen of the Alert setting.	
Settings for Look-ahead	Click to open the Look-ahead screen of the Alert setting.	
Settings for Special Condition Area	Click to open the Special Condition Area screen of the Alert setting.	

16.2.16 Setting up the display of range/bearing measurement function

When you select [Tools] in the classification pane, the [Tools] dialog is displayed in the edit pane.

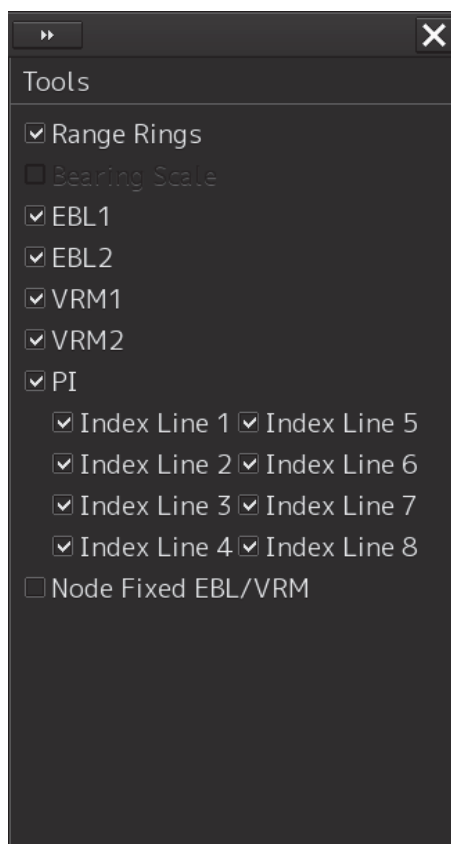

The descriptions of settings are shown in the table below.

Setting Item	Description of Setting	Setting Value
Range Rings	Selecting this enables to display range rings.	To enable: Select. To disable: Clear.
Bearing Scale	Selecting this enables to display the bearing scale. Note This item is displayed on the ECDIS screen only. This item is enabled only when overlay is set to On.	To enable: Select. To disable: Clear.
EBL1/EBL2	Selecting this enables to display the EBL1/EBL2 markers.	To enable: Select. To disable: Clear.
VRM1/VRM2	Selecting this enables to display the VRM1/VRM2 markers.	To enable: Select. To disable: Clear.
PI (parallel line cursor)	Select this to enable to display the PI cursors, and then select the PI cursors you want to display by selecting them.	To enable: Select. To disable: Clear. PI cursor selections Index Line 1 to Index Line 8
Node Fixed EBL/VRM	Selecting this enables to display the node fixed EBL/VRM.	To enable: Select. To disable: Clear.

16.2.17 Setting up the display of Unit of Setting Value

Note

Some items may not be displayed depending on the installation setting.

When you select [Unit] in the classification pane, the [Unit] dialog is displayed in the edit pane.



The descriptions of settings are shown in the table below.

Setting Item	Description of Setting	Setting Value
Depth (water depth)	Select a unit of water depth from the combo box.	m, ft, fm
Ship Speed	Select a unit of the ship speed from the combo box.	kn, m/s, km/h
Current Speed	Select a unit of the current speed from the combo box.	kn, m/s, km/h
Wind Speed	Select a unit of the wind speed from the combo box.	kn, m/s, km/h
Propeller Revolution	Select a unit of the propeller's revolution per minute from the combo box.	rpm, min-1
Propeller Pitch Angle	Select a unit of the propeller's pitch angle from the combo box.	°, %
Thruster Revolution	Select the unit of thruster revolution from the combo box.	rpm, min-1
Thruster Pitch Angle	Select a unit of the thruster's pitch angle from the combo box.	°, %, NOTCH
Air TEMP	Select a unit of the air temperature from the combo box.	°C, °F
Water TEMP	Select a unit of the water temperature from the combo box.	°C, °F
Air Pressure	Select a unit of the air pressure from the combo box.	hPa, mbar
Wind Direction(True)	Select a wind direction (true) display method from the combo box.	16points, Degree

16.2.18 Setting up display of Own Ship Track Control, display format of Own Ship/Cursor Position and display of Sub-Information dialog

When you select [Control] in the classification pane, the [Control] dialog is displayed in the edit pane.

[RADAR Screen]

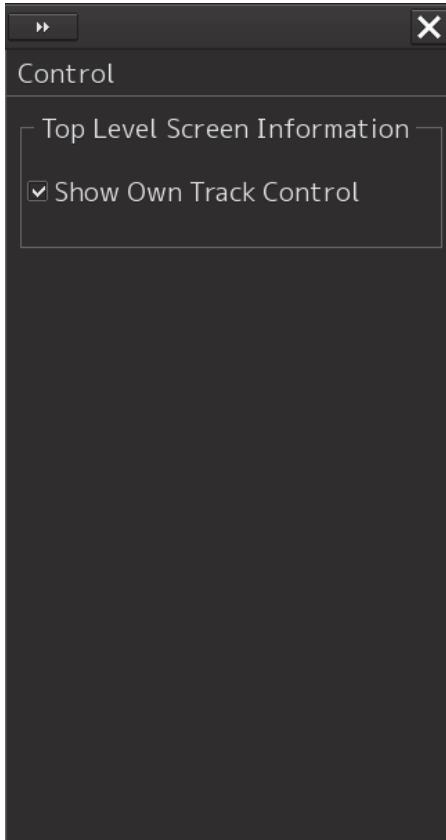

[ECDIS Screen]

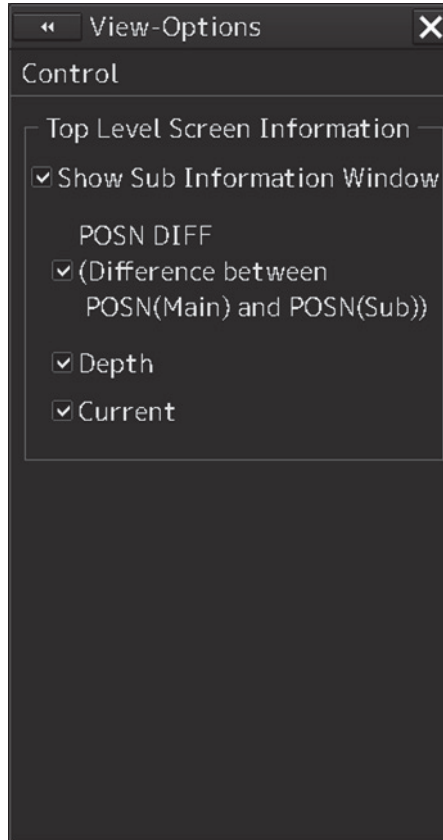

The descriptions of settings are shown in the table below.

Setting Item	Description of Setting	Setting Value
Show Own Track Control	Selecting this enables to display own track control. Note This item takes effect only on the RADAR screen.	To enable: Select. To disable: Clear.
Show Sub Information Window (sub information dialog box display)	Select this to enable to display the sub information dialog box, and then select the tab(s) you want to display. Note <ul style="list-style-type: none"> The [Depth] tab can only be selected when equipped with a water depth sensor. The [Current] tab can only be selected when equipped with a GPS, a gyro and a log sensor. 	To enable: Select. To disable: Clear. Tab selections POSN DIFF(Difference between POSN(Main) and POSN(Sub)), Depth, Current

16.2.19 Setting up the Water Depth display

When [Depth Graph] is selected on the classification pain, the [Depth Graph] dialog is shown on the Edit pain.

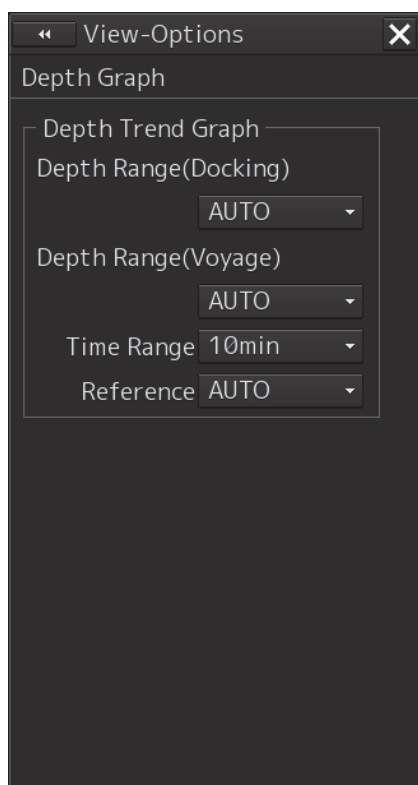

The following table shows the setting details:

Setting item	Description	Setting values
Depth Range(Docking)	Select a depth range for the docking depth graph from the combo box.	AUTO, 10 m, 25 m, 50 m
Depth Range(Voyage)	Select a depth range for the route depth graph from the combo box.	AUTO, 50 m, 100 m, 250 m
Time Range	Select a time range for the depth graph from the combo box.	10 min, 15 min, 30 min, 60 min, 12 hours
Reference	Switch the reference of the water depth value. AUTO: Switch the reference of the water depth value according to the received value. Keel: Set the reference of the water depth to keel. Transducer: Set the reference of the water depth to transducer. It can be selected only when FURUNO is selected in [Device Installation] - [Echo Sounder 1]. Surface: Set the reference of the water depth to surface. It can be selected only when FURUNO is selected in [Device Installation] - [Echo Sounder 1].	AUTO, Keel, Transducer(When FURUNO is selected), Surface(When FURUNO is selected)

16.2.20 Setting up the Rudder graph

When [Rudder Graph] is selected on the classification pain, the [Rudder Graph] dialog is displayed on the edit pain.

Note

This dialog may not be displayed depending on the equipment setting.



The following table shows the setting details:

Setting item	Setting	Setting value
Time Range	Select a time range for the Rudder graph from the combo box.	5 min, 10 min, 15 min, 30 min
Rudder Range	Select a rudder angle for the Rudder graph from the combo box.	30°, 40°, 50°, 60°, 70°, 80°

16.2.21 Setting up the Gyro/Rudder graph

When [Gyro/Rudder Graph] is selected on the classification pain, the [Gyro/Rudder Graph] dialog is displayed on the edit pain.

Note

This dialog may not be displayed depending on the equipment setting.



The following table shows the setting details:

Setting item	Setting	Setting value
Time Range	Select a time range for the Gyro/Rudder graph from the combo box.	5 min, 10 min, 15 min, 30 min
Rudder Range	Select a rudder angle for the Gyro/Rudder graph from the combo box.	30°, 40°, 50°, 60°, 70°, 80°

16.2.22 Setting up the Engine Graph

When [Engine Graph] is selected on the classification pain, the [Engine Graph] dialog is displayed on the edit pain.

Note

This dialog may not be displayed depending on the equipment setting.

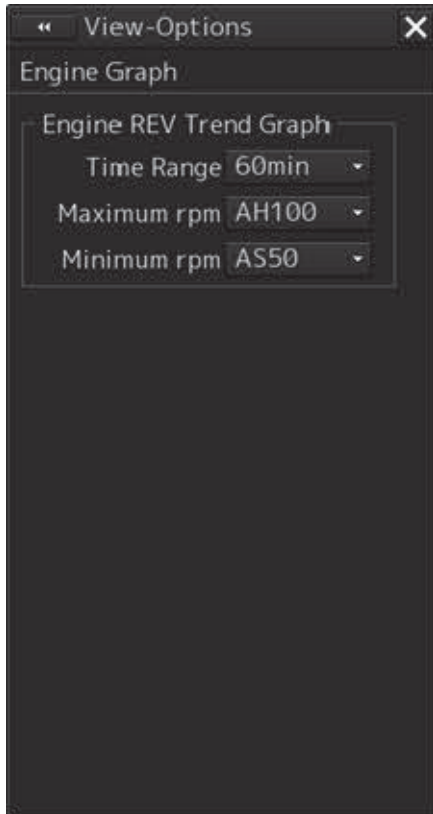

The following table shows the setting details:

Setting item	Setting	Setting value
Time Range	Select a time range for the engine speed graph form the combo box.	10 min, 15 min, 30 min, 60 min
Maximum rpm	Select an engine speed on the Ahead side form the combo box.	AH100, AH200, AH300, AH500, AH1000
Minimum rpm	Select an engine speed on the Astern side form the combo box.	0, AS50, AS100

16.2.23 Setting up the graph range of the ROT slide bar

When [ROT] is selected on the classification pain, the [ROT] dialog is displayed on the edit pain.

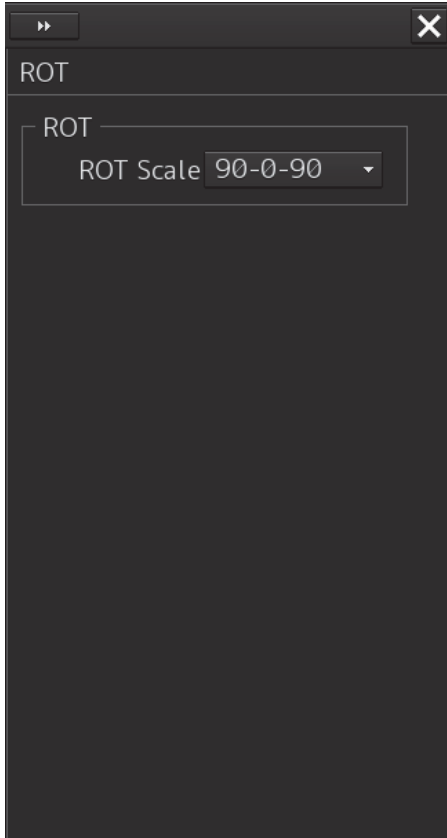

The following table shows the setting details:

Setting item	Setting	Setting value
ROT Scale	Select a graph range for the ROT slide bar from the combo box.	30-0-30, 60-0-60, 90-0-90, 120-0-120, 150-0-150, 300-0-300

Section 17 Setting up Alerts

By setting this equipment to generate an alert when the own ship's position or the condition meets the specific condition or any other ship or obstacle approaches to a specific range, preliminary measures can be taken, avoiding collisions, grounding, and deviation from the route can be avoided.

This section explains the method of setting conditions (threshold values) for generating alerts, alert processing operations, and alert timer setting using the [Alert] menu.

17.1 Selecting Setting Items

When the [Alert] menu is opened, the [Alert] dialog box appears.

By selecting a setting item in the [Alert] dialog box, the setting dialog of the selected item can be displayed.

17.1.1 Displaying the [Alert] dialog box

- 1 Click on the [Menu] button on the left toolbar.



The menu is displayed.

- 2 Click on the [Alert] button on the menu.

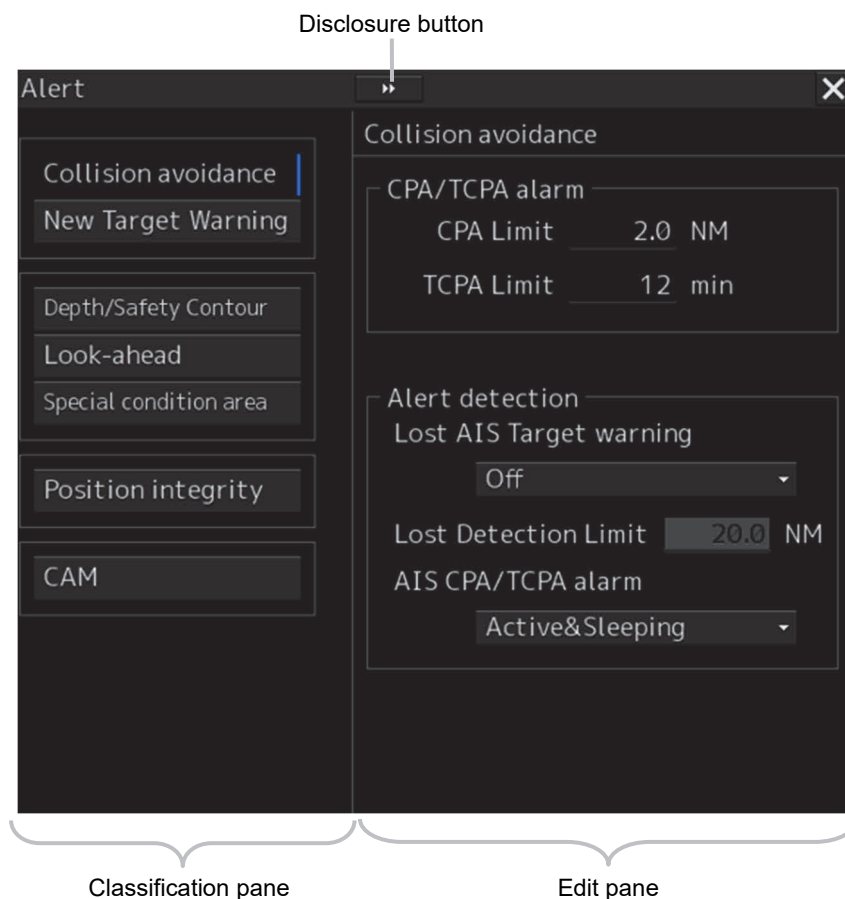
The [Alert] dialog box appears.



The [Alert] dialog box consists of the classification pane and the edit pane.

By clicking the Disclosure button (), you can hide the classification pane. To show the classification pane again, click the Disclosure button ().

17.1.2 Selecting a setting item

1 Click the alert classification you want to set up in the classification pane.

The setting dialog of the selected item is displayed in the edit pane.

2 Set up in the edit pane.

The following items can be set in the [Alert] dialog box.

Setting item	Setting contents	Function restriction
Collision Avoidance	Set the following conditions to generate a collision avoidance alert. <ul style="list-style-type: none"> • CPA/TCPA limit value • Status of the AIS target to be targeted for a lost alarm Refer to "17.2 Collision Avoidance Alert Generation Conditions".	
New Target Warning	Set the following conditions to generate an automatic acquisition target alarm. <ul style="list-style-type: none"> • Area (AZ) for TT target automatic acquisition • Enable/disable AZ Refer to "17.3 New Target Warning Generation Conditions".	
Depth/Safety Contour	Set the following conditions to generate a grounding avoidance alert. <ul style="list-style-type: none"> • Safety contour line approach alarm Refer to "17.4 Depth/Safety Contour Alert Generation Conditions".	The "Safety contour line approach alarm" can also be set on the ECDIS screen and the chart radar screen (when the chart option is set for the radar as chart display option).
Look-ahead (Forward forecast monitoring)	Set a forward forecast monitoring Refer to "17.5 Setting Up Look-ahead".	ECDIS screen and chart radar screen (when the chart option is set for the radar as chart display option)

Setting item	Setting contents	Function restriction
Special Condition Area	Set the conditions for generating a warning by detecting a danger detection vector. Refer to "17.6 Special Condition Area Generation Conditions".	ECDIS screen and chart radar screen (when the chart option is set for the radar as chart display option)
Position Integrity (Position sensor integrity)	Set the conditions for checking the Position Integrity and generating HDOP exceeded Maintenance Information. Refer to "17.7 Position Integrity Check Conditions".	
CAM (Central Alert Management)	Set the actions to be taken at the next stage for an unacknowledged alert. Refer to "17.8 Setting up Alert Processing".	

17.2 Collision Avoidance Alert Generation Conditions

When you select [Collision Avoidance] in the classification pane, the [Collision Avoidance] dialog is displayed in the edit pane.

In this dialog, the collision detection condition (CPA/TCPA limit) and the AIS target status, which is the target of alert detection, can be set.

For the details of CPA/TCPA, refer to "6.2 Collision Avoidance Issue (Explanation)".

Note

As for the values of collision detection conditions, please specify the optimal values according to the ship type, sea area, weather and marine conditions. (For the condition and type of each alert, refer to "6.7 Alert Display".)

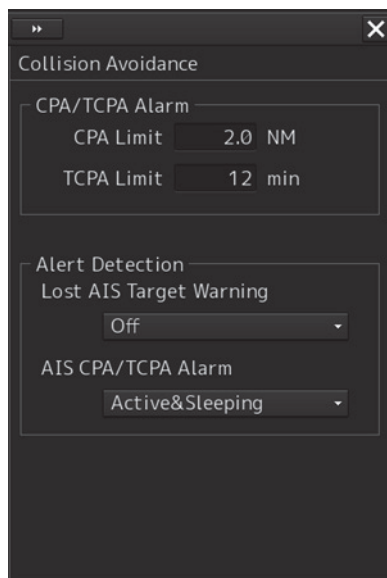

17.2.1 Setting the CPA/TCPA limit values

- 1 Enter the value of [CPA Limit] in a range from 0.1 NM to 9.9 NM.
- 2 Enter the value of [TCPA Limit] in a range from 1 min to 99 min.

17.2.2 Setting the status of the AIS target that is targeted for lost warning

- 1 Select a target for detecting a lost warning of the AIS target from the [Lost AIS target Warning] combo box.

ACT&Danger&Select: Activated AIS targets, danger targets and numeric value display targets are included.

Danger: Danger targets are included.

Off: Lost warnings are not generated.

Note

Lost warnings for sleeping AIS targets will not be generated.

Memo

If Off is being set, the following message is displayed in the alert status area.
Lost AIS target Warning is Disabled

- 2 Select a target for detecting a CPA/TCPA alarm of the AIS target from the [AIS CPA/TCPA Alarm] combo list.

ACT & Sleeping: Activated AIS targets and sleeping AIS targets are included.

Active: Activated AIS targets are included.

Off: CPA/TCPA alarms are not generated.

Note

During the ECDIS task, the Collision Avoidance item is hidden from the classification pane, and CPA / TCPA alert and Lost alert are not detected and sounded.

Also, drawing on the chart of AIS dangerous ship and AIS lost target will not be done.

Regarding TT, the dangerous ship and the lost target are drawn.

17.3 New Target Warning Generation Conditions

When you select [New Target Warning] in the classification pane, the [New Target Warning] dialog is displayed in the edit pane.

In this dialog, it is possible to set the AZ (automatic acquisition/activation zone) and switch the AZ to enable/disable.

For the details of the setting of the AZ, refer to "6.5.1.1 Automatic acquisition mode".

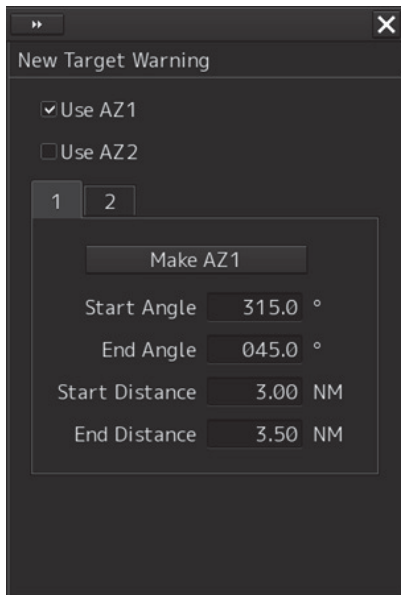

Settings of AZ1
(Automatic Acquisition/Activation Area 1)

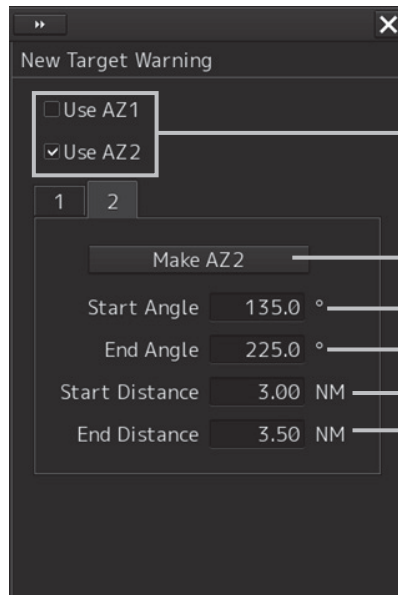

Settings of AZ2
(Automatic Acquisition/Activation Area 2)

When one of these is selected, AZ1 or AZ2 takes effect.

When this is clicked on, the cursor mode is set to a Make AZ mode.

Enter the start angle.

Enter the end angle.

Enter the start distance.

Enter the end distance.

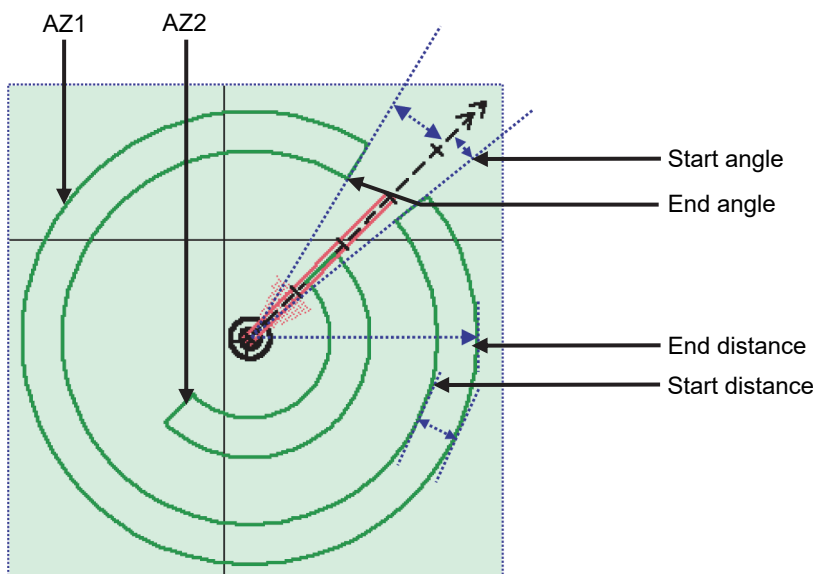

17.3.1 Switching AZ1/AZ2 to enable/disable

17.3.1.1 Enabling AZ1 or AZ2

Select the [Use AZ1] or [Use AZ2] check box.

A TT target / AIS target in the applicable AZ is automatically acquired / activated and it becomes a target of collision detection.

A "  " mark and identification number are assigned to the acquired TT target on the radar screen, which are moved together with the TT target, and then a vector is displayed within 1 min.

17.3.1.2 Disabling AZ1 or AZ2

Clear the [Use AZ1] or [Use AZ2] check box.

Acquired and activated zones disappear from the RADAR screen. However, already acquired TT targets are continuously tracked. Moreover, activated AIS targets remain activated.

17.4 Depth/Safety Contour Alert Generation Conditions

When [Depth/Safety Contour] is selected in the classification pane, the [Depth/Safety Contour] dialog is displayed in the edit pane.

In this dialog, the threshold values for generating "Crossing safety contour alarm" can be set up.

Note

[Crossing safety contour alarm] cannot be displayed on the RADAR screen.

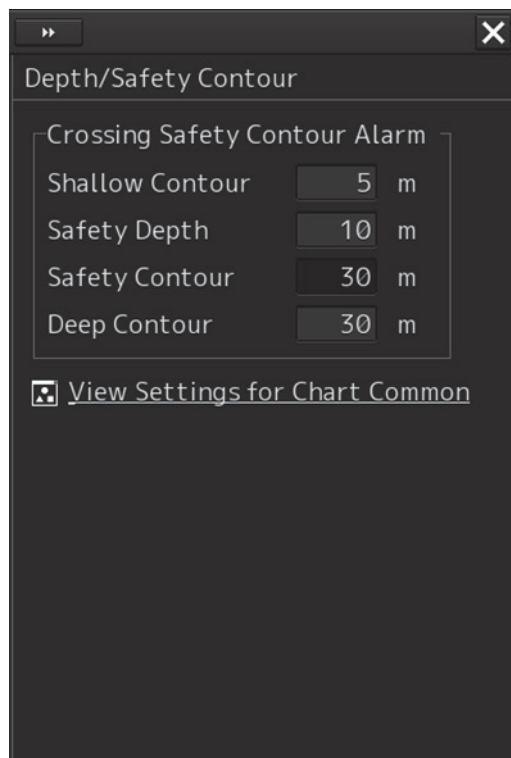

Each threshold value can be set in a range between 0 and 200 m.

In the [Shallow contour], [Safety depth] and [Deep contour] input boxes, the values set in [Options] - [Chart Common] of the View menu are displayed.

When [View Settings for Chart Common] is clicked, the [Chart Common] dialog box of the View menu appears.

For the details of each setting item, refer to "16.2.11 Setting up the display of Chart Common".

- Shallow Contour
- Safety Depth
- Safety Contour
- Deep Contour

Automatic compensation of entered values

The threshold values must satisfy the following conditions.

- Shallow Contour \leq Safety Contour \leq Deep Contour
- Shallow Contour \leq Safety Depth \leq Deep Contour

Safety Contour and Safety Depth are not related.

If there is any contradiction in the entered values, the following automatic compensations will be performed.

Condition	Compensation
Safety contour value (or Safety Depth value) < Shallow contour value	Replace the Shallow contour value with the Safety contour value (or Safety Depth value)
Deep contour value < Safety contour value (or Safety Depth value)	Replace the Deep contour value with the Safety contour value (or Safety Depth value)

17.5 Setting Up Look-ahead

When [Look-ahead] is selected in the classification pane, the [Look-ahead] dialog is displayed in the edit pane.

In this dialog, the selection of the sizes of both a danger detection vector/sector and the switching to enable/disable of them are possible.



This unit can monitor when own ship tries to cross over the preset safety contour or danger area, or when dangerous objects enter the sector specified around own ship. For this monitoring, danger detection vectors and sectors can be displayed. As for danger detection vectors, detection ranges for crossover of safety contours and danger areas can be specified in units of minutes or nautical miles, and notches on vectors and tips of vectors indicate predicted positions if navigated at the current speed. Also, the radius of a sector can be set up in units of miles or minutes.

Radius of a danger detection sector
(1.0 min to 30.0 min/0.1 NM to 5.0 NM)

Length of a dangerous detection vector
(1.0 min to 30.0 min/0.1 NM to 5.0 NM)

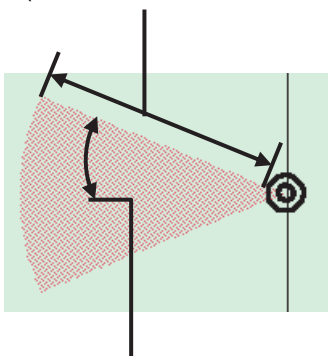

Angle of a danger detection sector
(0.1 degrees to 360.0 degrees)

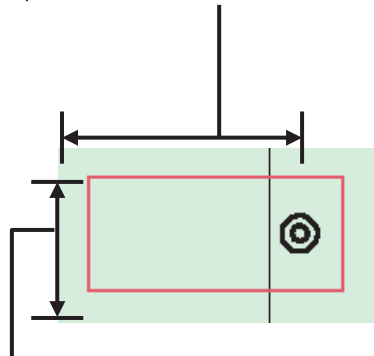

Width of a dangerous detection vector
(Width of own ship to 25.0 m)

Dangerous Detection Vector and Sector

17.5.1 Switching to enable/disable a danger detection vector/sector

To enable a danger detection vector/sector, select [Use Area(Rectangle)] and/or [Use Area(Sector)] check box.

A danger detection vector and a danger detection sector appear on the chart.

To disable a danger detection vector/sector, clear [Use Area(Rectangle)] and/or [Use Area(Sector)] check box.

A danger detection vector and a danger detection sector disappear from the chart.

17.5.2 Setting up the size of a danger detection vector

1 Enter a value in [Length].

Specify it in a range between 1.0 and 30.0 min or between 0.1 and 5.0 NM.

The unit of the vector length can be switched between min and NM by clicking on the Change Unit button,

2 Enter a value in [Width].

Specify the vector width in a range between own ship's beam +15 m to 250.0 m.

17.5.3 Setting up the size of a danger detection sector

1 Enter a value in [Radius].

Specify it in a range between 1 and 30 min or between 0.1 and 5.0 NM.

The unit of the sector radius can be switched between min and NM by clicking on the Change Unit button,

2 Enter a value in [Width].

Specify the sector width in a range between 0.1 and 360.0°.

17.6 Special Condition Area Generation Conditions

When [Special Condition Area] is selected in the classification pane, the [Special Condition Area] dialog is displayed.

In this dialog, set an area for generating a alert when the symbol on the chart touches the danger detection vector.

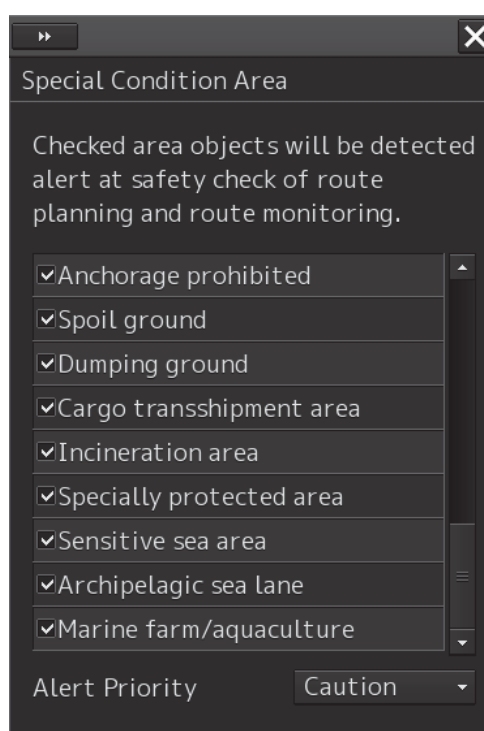
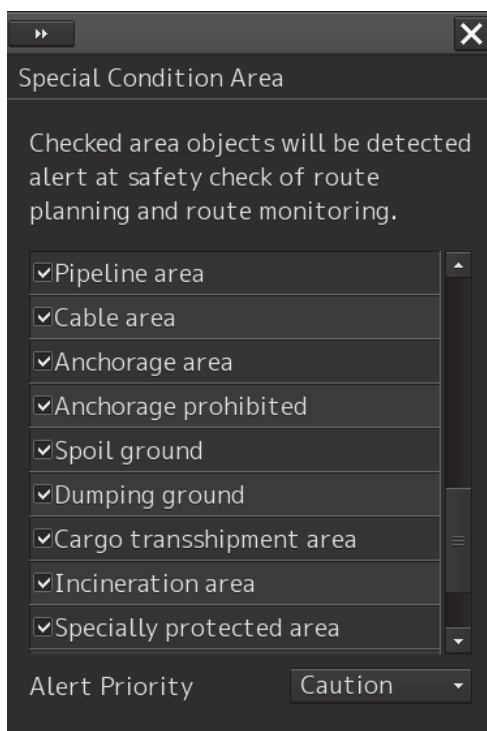
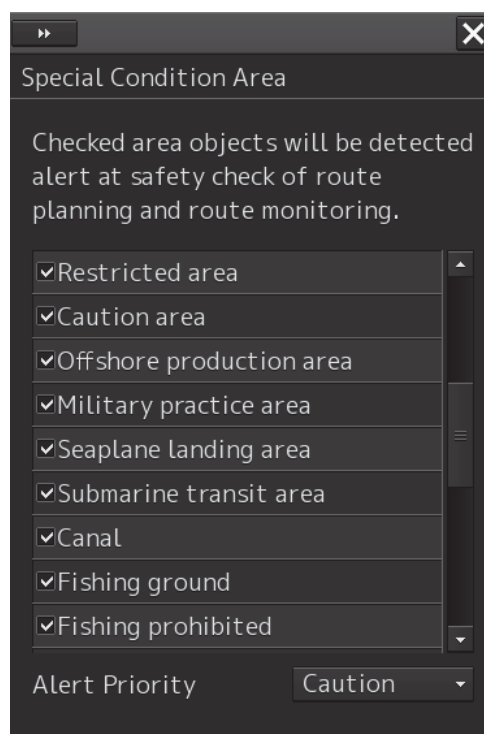
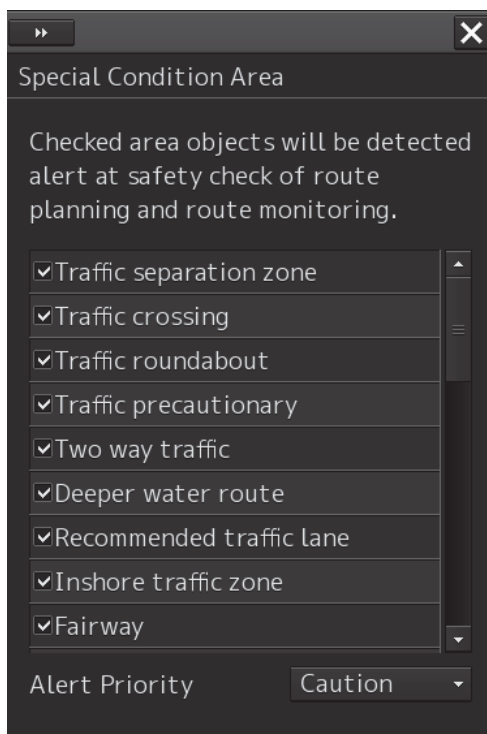

Select the check box of the area that is targeted for the alert.
Clear the check box of the area not to be targeted for the alert.

When you select Warning or Caution in the **Alert Priority combo box**, the alert priority is set at once.
If priority is changed during alert occurrence, it will be regenerated.

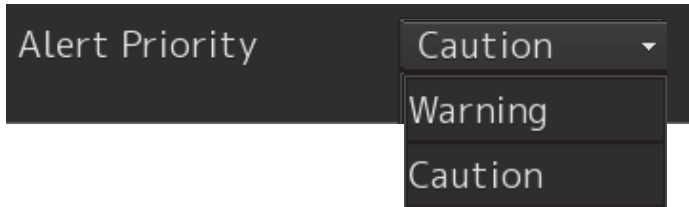

17.7 Position Integrity Check Conditions

When [Position Integrity] is selected in the classification pane, the [Position] dialog is displayed. In this dialog, the generation condition of the Position integrity limit and the HDOP limit can be set up.

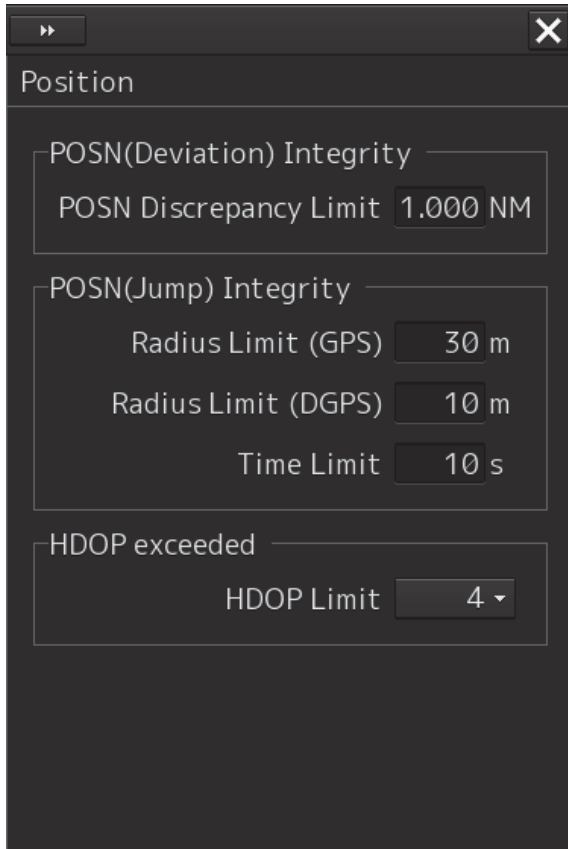

The screenshot shows a dark-themed dialog box titled "Position". It contains three sections for setting integrity limits:

- POSN(Deviation) Integrity:** A text input field for "POSN Discrepancy Limit" is set to "1.000 NM".
- POSN(Jump) Integrity:** Three text input fields: "Radius Limit (GPS)" is set to "30 m", "Radius Limit (DGPS)" is set to "10 m", and "Time Limit" is set to "10 s".
- HDOP exceeded:** A dropdown menu for "HDOP Limit" is set to "4".

17.7.1 Setting up the condition of the Position Integrity Check

Enter the following threshold values for checking the Position Integrity.

Position Discrepancy Limit:

The difference in distances when two GPS positions are compared at every second is used as a threshold value. Specify the difference in a range between 0.010 and 9.990 NM.

Note

Position Discrepancy Limit takes effect when two GPSs are installed.

Radius Limit (GPS):

The radius of a monitoring circle having the predicted position of a GPS 1 sec later at the center is used as a threshold value. If the position actually measured is not within the time monitoring circle specified in [Time Limit], it will be subjected to an alert. Specify the radius limit in a range between 10 and 100 m.

Radius Limit (DGPS):

The radius of a monitoring circle having the predicted position of DGPS 1 sec later at the center is used as a threshold value. If the position actually measured is not within the time monitoring circle specified in [Time Limit], it will be subjected to an alert. Specify the radius limit in a range between 10 and 100 m.

Time Limit:

The time during which the position actually measured by a GPS/DGPS deviates from the monitoring circle is used as a threshold value. The time limit can be specified in a range between 1 and 29s.

17.7.2 Setting up the generation condition of the HDOP exceeded Maintenance Information

In the [HDOP Limit] combo box, select a threshold limit of HDOP (Horizontal Dilution of Precision). Select either one of [4], [10] and [20].

17.8 Setting up Alert Processing

When [CAM] is selected in the classification pane, the [CAM] dialog is displayed on the edit pane. In this dialog, the time to activate the action at the next stage when acknowledge is not performed for an alert can be set up.

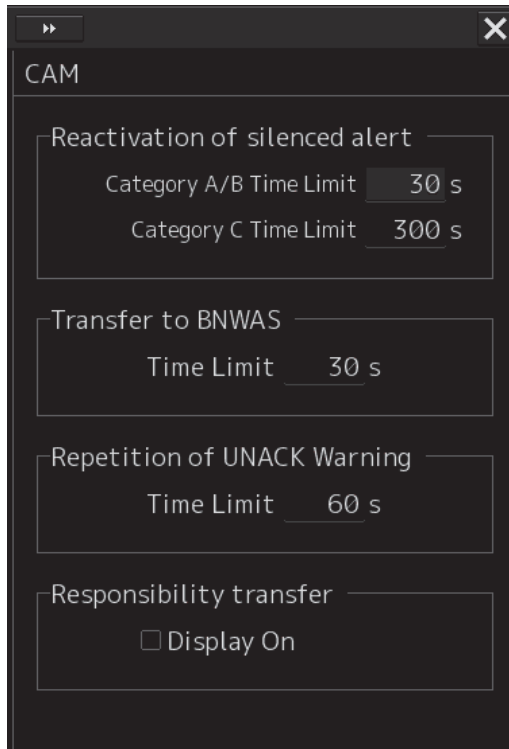

Enter the wait time until an alert at the next stage is generated in [Time Limit].

Reactivation of Silenced Alert:

Category A/B Time Limit: 30 seconds.

Category C Time Limit: Set, within the range from 0 to 300s, the time required to reactivate the alert sound that was silenced temporarily.

Transfer to BNWAS:

When a BNWAS (Bridge Navigational Watch Alarm System) is connected, specify the time to transfer an unacknowledged alert to the BNWAS in a range between 0 and 30s.

Repetition of UNACK Warning:

Specify the time to regenerate an unacknowledged alert as an audible warning in a range between 16 and 300s. A warning will be generated repeatedly until it is acknowledged. The default value is 60 s.

Note

This is not applicable to the following warnings according to the Standard (operation that is defined in the IEC62065 (TCS) or IEC61174 (ECDIS) Standard). Warning are escalated to alarm, if warning was not acknowledged for the following times.

- Early Course Change Warning, Actual Course Change Warning, End Of Track Warning and Track Control Stopped Warning: 30 seconds (fixed)
- Outside Anchor Watch Area Warning: 120 seconds. (fixed)

Responsibility Transfer:

When click the check box, display of responsibility transferred alert is switched to ON or OFF.



Display of Responsibility transferred alert: ON



Display of Responsibility transferred alert: OFF



Section 18 Setting up the Operation Mode

18.1 Basic Operation of the [Settings] Dialog Box

You can set up the operation mode in the [Settings] dialog box.

- 1 Click on the [Menu] button on the left toolbar.

The menu is displayed.

- 2 Click on the [Settings] button.

The [Settings] dialog box appears.

The [Settings] dialog box consists of the classification pane and the edit pane.

Click on the Disclosure button (>>) to hide the classification pane. To show the edit pane again, click on the Disclosure button (<<).

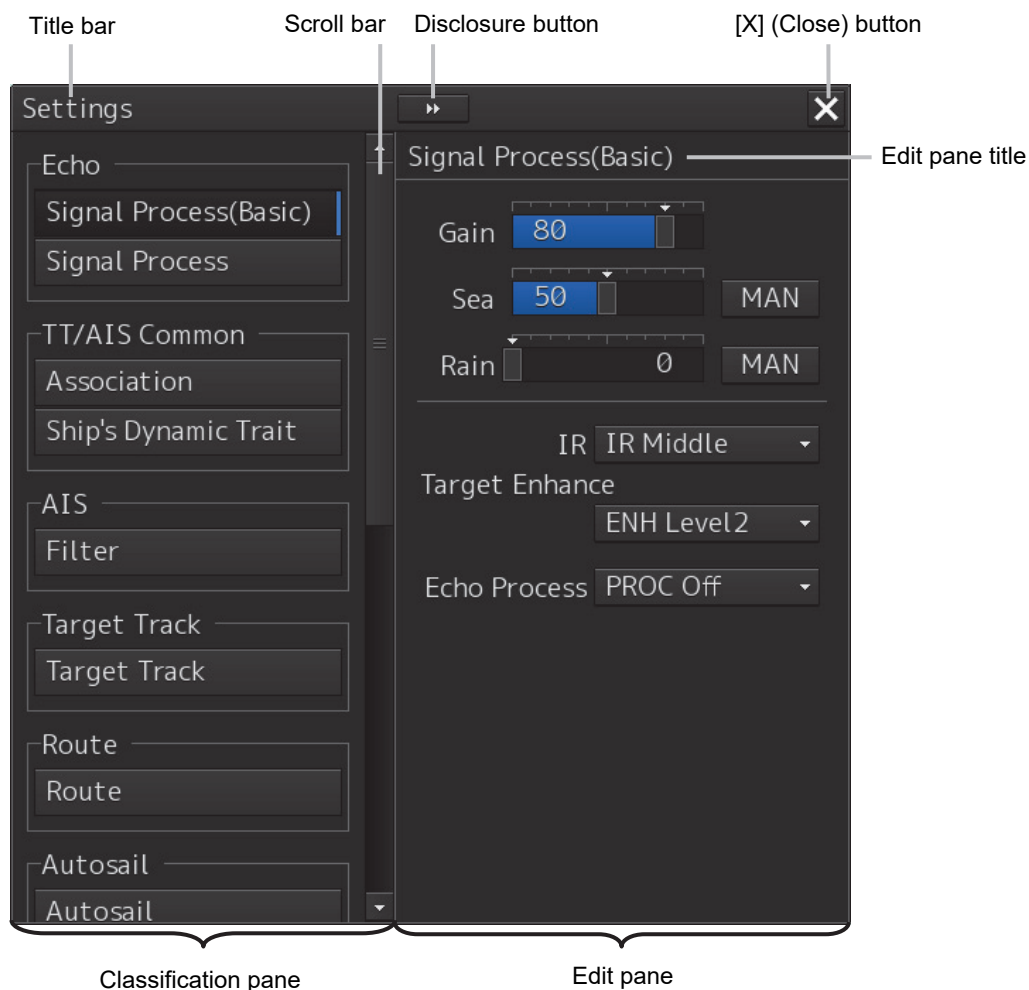

Display Example for the ECDIS

-
-
- 3** When all the classification panes are not displayed, drag the scroll bar upwards and downwards.

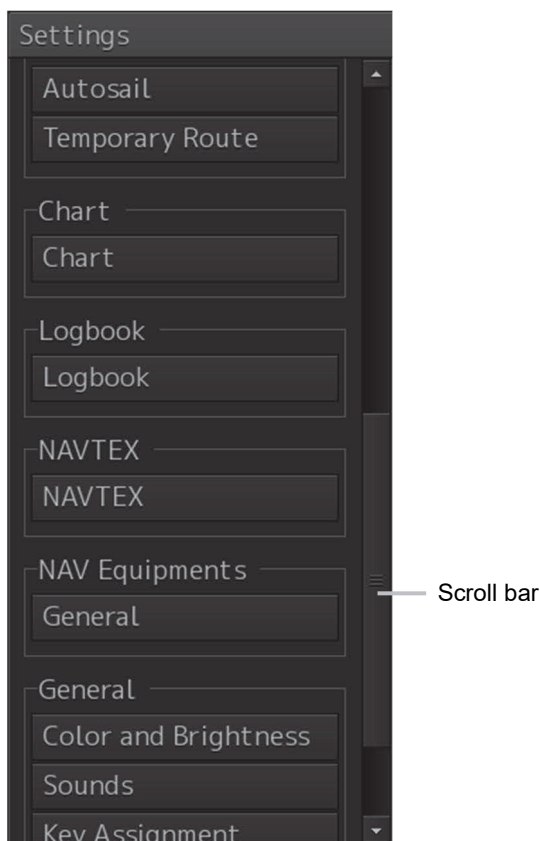

ECDIS display example

- 4** Click on the item you want to set up in the classification pane.
The setup dialog of the item you selected is displayed.
- 5** Set up in the edit pane.

Classification pane display targets

The table below provides the descriptions of the classification panes that are displayed by RADAR and ECDIS and the related sections.

Classification pane	Display target		Related section
	RADAR	ECDIS	
Signal Process(Basic)	-	○	18.2 Basic Settings for Radar Signal Processing
Signal Process	○	○	18.3 Setting Radar Signal Processing
Obs, Scene Preset	○	-	18.4 Presetting Each Observation Scene
Trails	○	-	18.5 Setting Other Ship's Radar Trails
TXRX	○	-	18.6 Setting Radar Antennas
Association	○	○	18.7 Setting Associations
Ship's Dynamic Trait	○	○	18.8 Setting Dynamic Traits of Own Ship
TT Test	○	-	18.9 Setting Operation Tests
Filter	○	○	18.10 Setting AIS Filters
Target Track	○	○	18.11 Setting the Target Track Function to ON/OFF
Route	○	○	18.12 Setting Parameter Values at Route Plan Creation
Autosail*1	○	○	18.13 Setting Automatic Sailing Parameter Values
Temporary Route	○	○	18.14
Chart*2	-	○	18.15 Setting Chart Operation
Logbook	-	○	18.16 Setting Logbook
NAVTEX	○	○	18.17 Setting NAVTEX
General	○	○	18.18 Setting Navigation Equipment
Color and Brightness	○	○	18.19 Setting Colors and Brightness
Sounds	○	○	18.20 Setting Sounds
Key Assignment	○	○	18.21 Setting Key Assignment
Preferences	○	○	18.22 Setting Preferences Information
Screen capture	○	○	18.23 Setting Screen Capture

*1 Displayed when the automatic sailing option is attached.

*2 Displayed when the chart display option is attached.

18.2 Basic Settings for Radar Signal Processing

Select [Signal Process (Basic)] in the classification pane.

Set a basic processing method of radar signals in the setting dialog of the edit pane (ECDIS screen only).



Setting Item	Description of Setting	Setting Value
Gain	Rotate the dial to set the mode to the receiving sensitivity adjustment mode.	0 to 100
Sea (sea clutter adjustment)	Rotate the dial to set the mode to the sea clutter adjustment mode. By clicking on the dial in adjustment mode or clicking on the button next to the slider, the mode can be switched between manual (MAN) and automatic (AUTO).	0 to 100 MAN: Manually removes sea clutters. AUTO: Automatically removes sea clutters.

Setting Item	Description of Setting	Setting Value
Rain (rain/snow clutter adjustment)	<p>Rotate the dial to set the mode to the rain/snow clutter adjustment mode.</p> <p>By clicking on the dial in adjustment mode or clicking on the button next to the slider, the mode can be switched between manual (MAN) and automatic (AUTO).</p>	<p>0 to 100</p> <p>MAN: Manually removes rain/snow clutters.</p> <p>AUTO: Automatically removes rain/snow clutters.</p>
IR	Set up the IR (Interference Removal) function.	<p>Off</p> <p>IR Low</p> <p>IR Middle</p> <p>IR High</p>
Target Enhance	Set up the Target Enhance function.	<p>ENH Off</p> <p>ENH Level1</p> <p>ENH Level2</p> <p>ENH Level3</p>
Echo Process	<p>Set up the Echo Process function.</p> <p>If the ship's heading cannot be acquired, [PROC Off] is set.</p>	<p>PROC Off</p> <p>3 Scan CORREL</p> <p>4 Scan CORREL</p> <p>5 Scan CORREL</p> <p>Remain</p> <p>Peak Hold</p>

18.3 Setting Radar Signal Processing

Set [Signal Process] in the classification pane.

Set various processing methods for radar signals in the setting dialog of the edit pane.

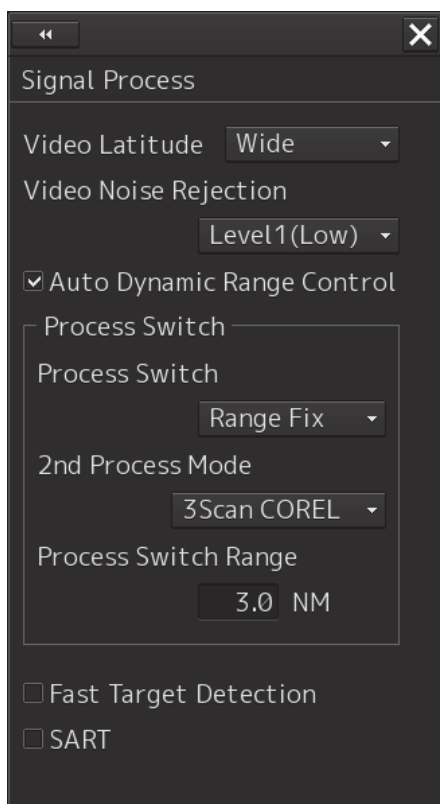

Setting Item	Description of Setting	Setting Value
Video Latitude	Set up the gradation of the radar video.	Narrow Normal Wide Super Wide
Video Noise Rejection	Set up to remove noise and signals which are considered to be clutters of radar video.	Off Level1(Low) Level2(High)
Auto Dynamic Range Control	When this is selected, the dynamic range is automatically adjusted.	To enable: Select. To disable: Clear.
Process Switch	Specify a particular area and set up a mode for performing video processing on the inside and outside of the particular area.	Off Range Fix AUTO
2nd Process Mode	Set up a processing mode used in the outside of the particular area. This is enabled when other than [Off] is being selected in the Process Switch combo box.	PROC Off 3Scan CORREL 4Scan CORREL 5Scan CORREL Remain Peak Hold

Setting Item	Description of Setting	Setting Value
Process Switch Range	Set up the boundary range of a particular area. Enabled when [Range Fix] is selected in the Process Switch combo box.	0.1 to 25.5 NM
Fast Target Detection	When this item is enabled, high-speed moving targets that are suppressed by the scan correlation processing can be detected more easily.	To enable: Select. To disable: Clear.
SART	If it is enabled, the Radar Transponder (SART: Search and Rescue Radar Transponder) screen can be displayed. This item is valid on the RADAR screen only.	To enable: Select. To disable: Clear.

18.4 Presetting Each Observation Scene

CAUTION



Adjust the preset of the observation scene according to the oceanographic condition, with the thorough understanding of the features of the radar signal processing setting. The optimum radar performance may not be able to be demonstrated due to the contents of the changed setting or the oceanographic condition at that time.

There are 12 types of observation scenes; you can preset each observation scene.

When you select [Obs, Scene Preset] in the classification pane, the items that can be preset are divided into six setup dialogs, which are then displayed in the edit pane.

To proceed to the next page: Click the [Next] button.

To return to the previous page: Click the [Back] button.

Settings
Preset - Standard page 1/6

Obs.Scene Standard

IR IR Middle

Target Enhance
ENH Level2

Echo Process
PROC Off

Sea MAN

Rain MAN

Save Present State

Next

Settings
Preset - Standard page 2/6

Obs.Scene Standard

Pulse Width

0.75(0.75 to 1.5)NM MP1

1.5(1.5 to 3)NM MP1

3(3 to 6)NM MP2

6(6 to 12)NM MP2

12(12 to 16)NM MP3

Back Next

Settings
Preset - Standard page 3/6

Obs.Scene Standard

Video Latitude Wide

Video Noise Rejection
Level1(Low)

AUTO Dynamic Range Control

Process Switch
Process Switch
Off

2nd Process Mode
Remain

Process Switch Range
3.0 NM

Fast Target Detection

Back Next

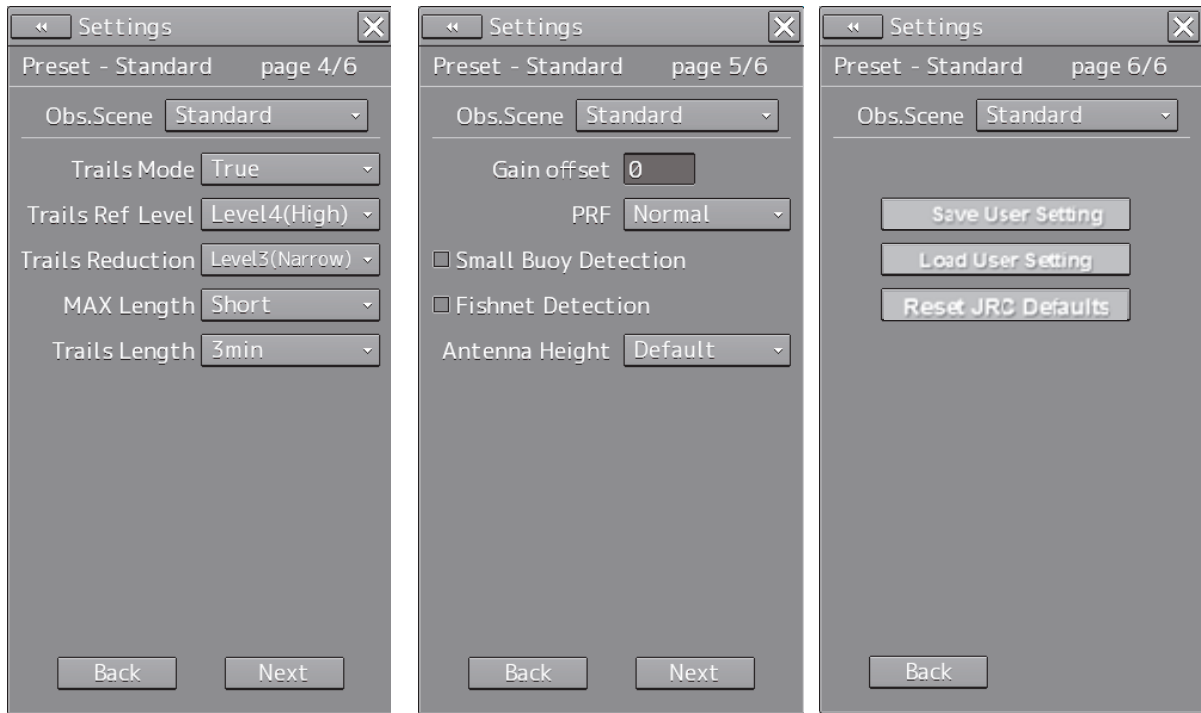

Setting Item	Description of Setting	Setting Value
Obs.Scene	Set up the observation scene.	Standard Coast Open-sea Fishnet Storm Calm Rain Bird Long Range Buoy User1 User2
IR	Set up the IR (Interference Removal) function.	Off IR Low IR Middle IR High
Target Enhance	Set up the Target Enhance function.	ENH Off ENH Level1 ENH Level2 ENH Level3
Echo Process	Set up the Echo Process function. If the ship's heading cannot be acquired, [PROC Off] is set.	PROC Off 3 Scan CORREL 4 Scan CORREL 5 Scan CORREL Remain Peak Hold

Setting Item	Description of Setting	Setting Value
Sea (sea clutter adjustment)	You can switch between MAN and AUTO.	MAN: Manually removes sea clutters. AUTO: Automatically removes sea clutters.
Rain (rain/snow clutter adjustment)	You can switch between MAN and AUTO.	MAN: Manually removes rain/snow clutters. AUTO: Automatically removes rain/snow clutters.
0.75 (0.75 to 1.5) NM	Select a pulse width of 0.75 NM range.	<Radar Antenna 10kW> SP1/MP1 <Radar Antennas 25kW, 30kW> SP1/MP1 <S-band solid state> SP1/MP1 <X-band solid state> SP1
1.5 (1.5 to 3) NM	Select a pulse width of 1.5 NM range.	<Radar Antenna 10kW> SP1/MP1/MP2 <Radar Antennas 25kW, 30kW> SP1/MP1/MP2/MP3 <S-band solid state> SP1/MP1/MP2 <X-band solid state> SP1/MP1
3 (3 to 6) NM	Select a pulse width of 3 NM range.	<Radar Antenna 10kW> SP1/MP1/MP2/LP1 <Radar Antenna 25kW> SP1/MP1/MP2/MP3/LP1 <Radar Antenna 30kW> MP1/MP2/MP3/LP1 <S-band solid state> SP1/MP1/MP2/LP1/LP2 <X-band solid state> SP1/MP1/MP2
6 (6 to 12) NM	Select a pulse width of 6 NM range.	<Radar Antenna 10kW> SP1/MP1/MP2/LP1/LP2 <Radar Antenna 25kW> SP1/MP1/MP2/MP3/LP1/LP2 <Radar Antenna 30kW> MP1/MP2/MP3/LP1/LP2 <S-band solid state> MP1/MP2/LP1/LP2 <X-band solid state> SP1/MP1/MP2/LP1

Setting Item	Description of Setting	Setting Value
12 (12 to 16) NM	Select a pulse width of 12 NM range.	<Radar Antenna 10kW> SP1/MP1/MP2/LP1/LP2 <Radar Antenna 25kW> SP1/MP1/MP2/MP3/LP1/LP2 <Radar Antenna 30KW> MP1/MP2/MP3/LP1/LP2 <S-band solid state> MP2/LP1/LP2 <X-band solid state> SP1/MP1/MP2/LP1/LP2
Video Latitude	Set up the radar image.	Narrow Normal Wide Super Wide
Video Noise Rejection	Set up to remove noise and signals which are considered to be clutters of radar images.	Off Level1(Low) Level2(High)
Auto Dynamic Range Control	When this is selected, the dynamic range is automatically adjusted.	To enable: Select. To disable: Clear.
Process Switch	Specify an area and set up a mode for performing video processing on the inside and outside of the area.	Off Range Fix AUTO
2nd Process Mode	Set up a processing mode used in the outside of the area. This is enabled when other than [Off] is being selected in the Process Switch combo box.	PROC Off 3Scan CORREL 4Scan CORREL 5Scan CORREL Remain Peak Hold
Process Switch Range	Set up the boundary range of a particular area.	0.1 to 25.5 NM
Fast Target Detection	When this item is enabled, high-speed moving targets that are suppressed by the scan correlation processing can be displayed more easily. This setting takes effect when the [2nd Process Mode] is [PROC3 to 5].	To enable: Select. To disable: Clear.
Trails Mode	Select a radar trail display mode.	True Relative
Trails Ref Level	Set up a video level required to draw radar trails. The higher the level gets, the higher the threshold value for drawing radar trails becomes.	Level1(Low) Level2 Level3 Level4(High)

Setting Item	Description of Setting	Setting Value
Trails Reduction	Set up the radar trail reduction processing level. The higher the level gets, the stronger the reduction processing level becomes.	Off Level1(Wide) Level2 Level3(Narrow)
MAX Length	Select the maximum value of the time to display radar trails.	Short Long
Trails Length	Set up the interval for displaying radar trails.	<When Short is specified> Off/15s/30s/1 min/3 min/ 6 min/10 min/15 min/30 min/60 min <When Long is specified> Off/30 min/1 hour/2 hour/3 hour/...(thereafter, at intervals of 1 hour).../24 hour
Gain Offset	Set up the gain offset for sensitivity compensation.	-32 to 32
PRF	Set up the operation mode of the transmitter's repetition transmission frequency. [Economy] cannot be selected when a S-band solid state radar antenna is connected. If a S-band solid state radar antenna is connected while [Economy] is being selected, the setting will be reset to the default (factory preset) value. [Economy] and/or [High Power] cannot be selected when a X-band solid state radar antenna is connected. If X-band solid state radar antenna is connected while [Economy] and/or [High Power] is being selected, the setting will be reset to the default (factory preset) value.	Normal Economy High Power
Small Buoy Detection	Turn On/Off the small target detection mode.	To enable: Select. To disable: Clear.
Fishnet Detection	Turn On/Off the fishnet detection mode.	To enable: Select. To disable: Clear.
Antenna Height	Set up the radar antenna height. When this is set to [Default], the value that has been set in [Antenna Height] by selecting [Service] - [Adjustment] - [TXRX] is used.	Default -5m 5-10m 10-20m 20m-

Overview of the Observation Scene Preset function

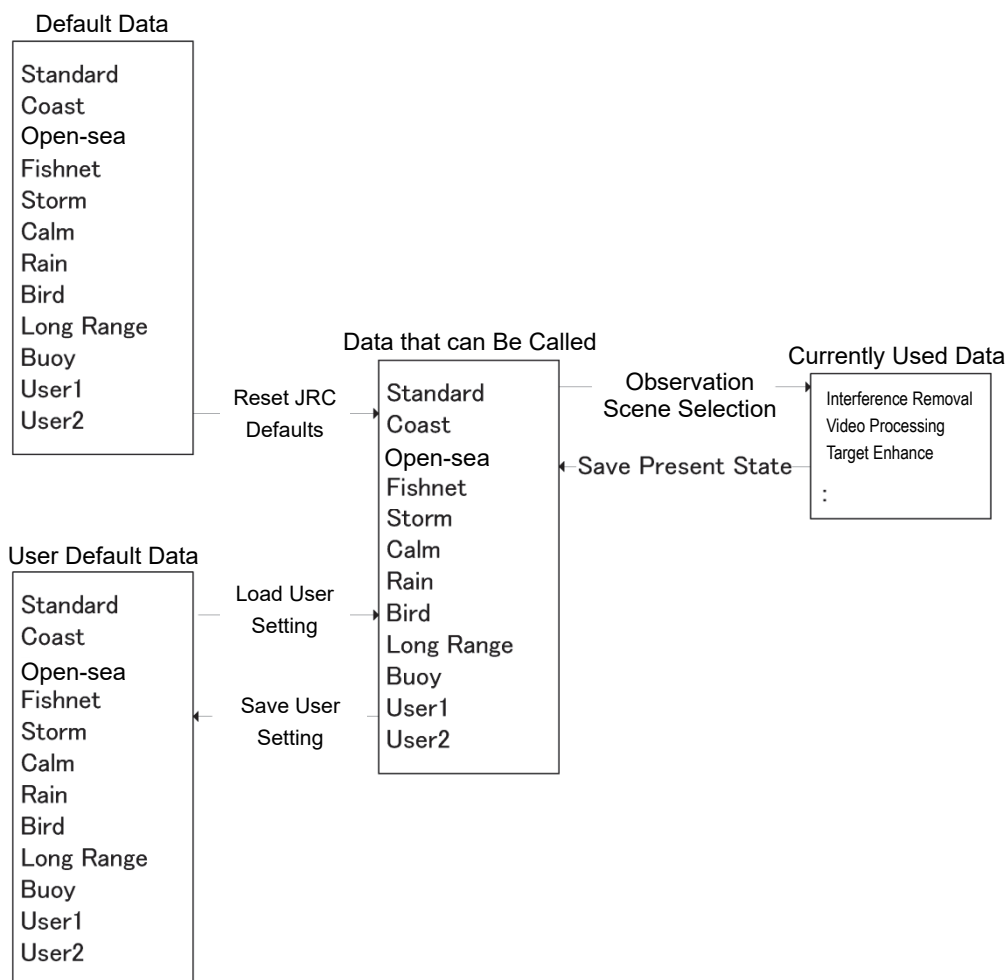

Setting Item	Description of Setting
Save Present State	The current settings are saved as the setting values of the currently selected observation scene. When this item is clicked on, the confirmation screen is displayed. To save the setting, click on [OK] and to cancel the operation, click on [Cancel].
Save User Setting	Data that can be called is saved as the user default values of the selected observation scene. When this item is clicked on, the confirmation screen is displayed. To save the setting, click on [OK] and to cancel the operation, click on [Cancel].
Load User Setting	Load the user default values to the data that can be called. When this item is clicked on, the confirmation screen is displayed. To call the set data, click on [OK] and to cancel the operation click on [Cancel].
Reset JRC Defaults	Load the default values to the data that can be called. When this item is clicked on, the confirmation screen is displayed. To call the set data, click on [OK] and to cancel the operation click on [Cancel].

18.5 Setting Other Ship's Radar Trails

Select [Trails] in the classification pane.

Set other ship's radar trails in the setting dialog of the edit pane (RADAR screen only).

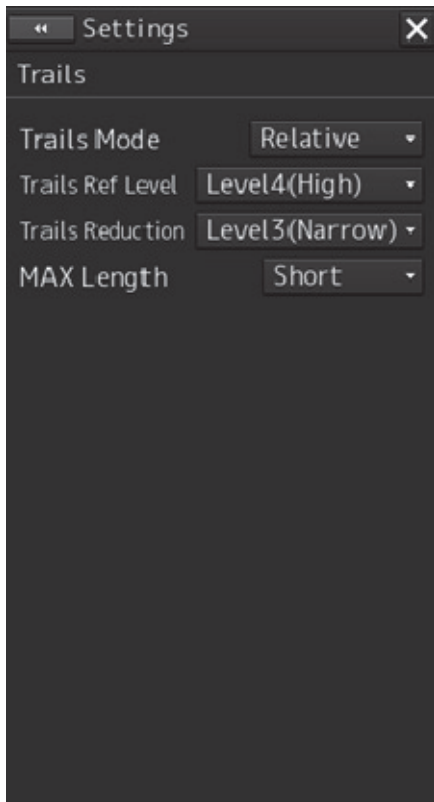

Setting Item	Description of Setting	Setting Value
Trails Mode	Select a radar trail display mode.	True Relative
Trails Ref Level	Set up a video level required to draw radar trails. The higher the level gets, the higher the threshold value for drawing radar trails becomes.	Level1(Low) Level2 Level3 Level4(High)
Trails Reduction	Set up the radar trail reduction processing level. The higher the level gets, the stronger the reduction processing level becomes.	Off Level1(Wide) Level2 Level3(Narrow)
MAX Length	Select the maximum value of the time to display radar trails.	Short Long

18.6 Setting Radar Antennas

Select [TXRX] in the classification pane.

Set radar antennas in the setting dialog of the edit pane (RADAR screen only).

18.6.1 Setting radar antennas

Set radar antennas.

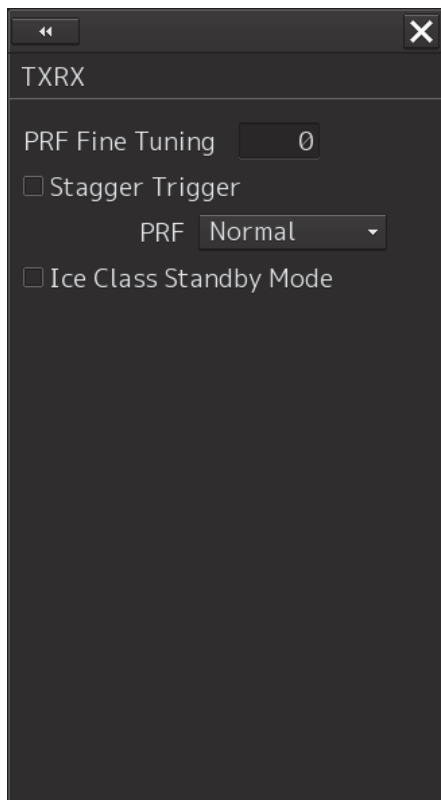

Setting Item	Description of Setting	Setting Value
PRF Fine Tuning	You can reduce the setting value of the repetition transmission frequency by 0.2% (maximum value is 0).	0 to 31
Stagger Trigger	Select On/Off of the Radio Wave Interference Reduction function. It is not displayed when a solid state radar antenna is connected. The previous setting value is maintained, however.	To enable: Select. To disable: Clear.
PRF	Set up the operation mode of the transmitter's repetition transmission frequency. [Economy] is not displayed when a S-band solid state radar antenna is connected. If a S-band solid state radar antenna is connected while an operation mode is being specified, the setting will be reset to the default value. [Economy] and [HighPower] is not displayed when a X-band solid state radar antenna is connected. If a X-band solid state radar antenna is connected while an operation mode is being specified, the setting will be reset to the default value.	Normal Economy High Power
Ice Class Standby Mode	Turn On/Off the Ice Class Standby mode.	To enable: Select. To disable: Clear.

Note

If a solid state radar antenna is connected, the setting in [Stagger Trigger] will not be saved and it will turn On (its check box is already selected) at each startup.

18.7 Setting Associations

Select [Association] in the classification pane.

Set TT/AIS in the setting dialog of the edit pane.

The AIS target and the tracking target are checked if they are identical and if so, an association symbol is displayed for the targets. In this case, the AIS target symbol is automatically activated.

Note

If you don't want to perform an identical target judgement, or if you want to display hidden symbols, turn the association setting to Off.

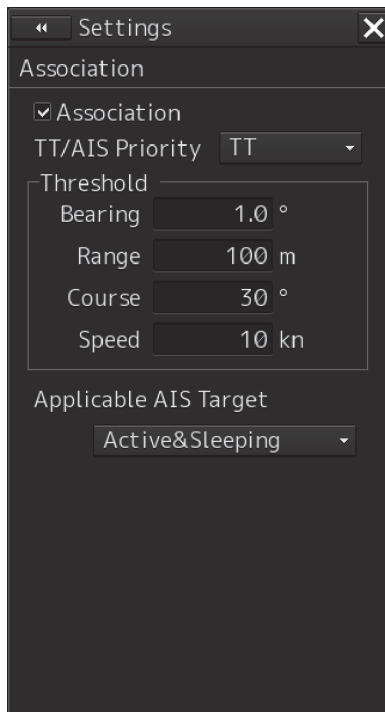

RADAR

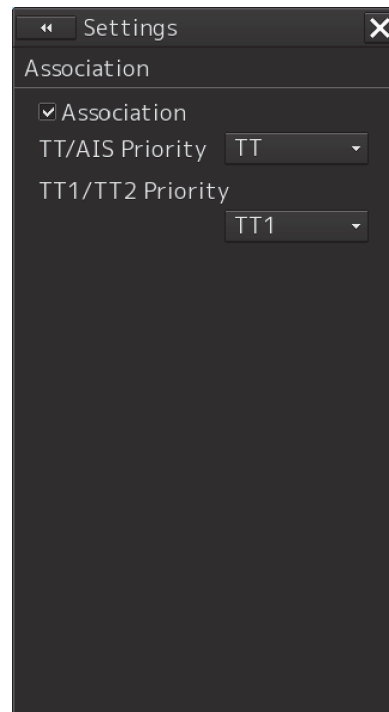

ECDIS

Setting Item	Description of Setting	Setting Value
Association	Turn On/Off the association setting.	To enable: Select. To disable: Clear.
Priority	Select a priority of association target display.	AIS TT
Bearing	Set up the bearing difference of the association target.	0.0 to 9.9°
Range	Set up the range difference of the association target.	0 to 999 m
Course	Set up the course difference of the association target.	0 to 99°
Speed	Set up the speed difference of the association target.	0 to 99 kn
Applicable AIS Target	Select a state of the AIS which will be an association target. Only the AIS target you specified will be an association target.	Active Active&Sleeping
TT/AIS Priority	Select priority of association target display.	AIS TT
TT1/TT2 Priority	Select priority of association target display.	TT1 TT2

18.8 Setting Own Ship's Dynamic Trait

Select [Ship's Dynamic Trait] in the classification pane.

Set dynamic traits of own ship in the setting dialog of the edit pane.

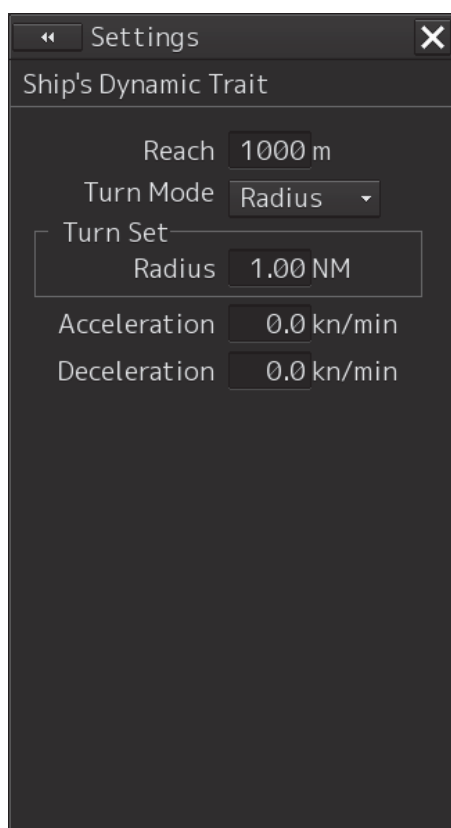

Setting Item	Description of Setting	Setting Value
Reach	Set up the distance to reach the turn.	0 to 2000 m
Turn Mode	Set up the Turn mode.	Radius Rate
Radius	Enter the radius of the turn rate. This is displayed when [Radius] is selected in the [Turn Mode] box.	0.10 to 2.00 NM
Rate	Enter the speed of the turn rate. This is displayed when [Rate] is selected in the [Turn Mode] box.	20 to 720°/min
Acceleration	Enter the rate of change of speed (acceleration) of own ship's dynamic trait.	0.0 to 100.0 kn/mir
Deceleration	Enter the rate of change of speed (deceleration) of own ship's dynamic trait.	0.0 to 100.0 kn/mir

18.9 Setting Operation Tests

Select [TT Test] in the classification pane.

Set an operation test in the setting dialog of the edit pane (RADAR screen only).

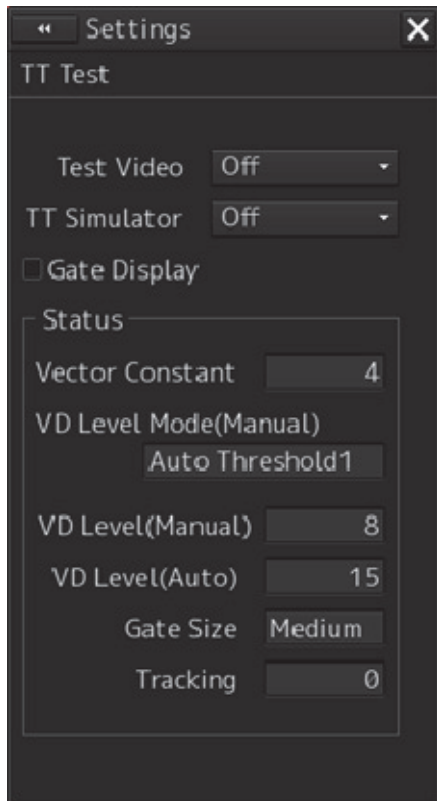

Setting Item	Description of Setting	Setting Value
Test Video	Set up the type of test video.	Off VDIN
TT Simulator	Set up the scenario of the TT Simulator mode.	Off Scenario1 Scenario2 Scenario3 Scenario4 Scenario5 Scenario6
Gate Display	Switches between On/Off of the Gate Display mode.	To enable: Select. To disable: Clear.
Vector Constant	Set up the vector's tracking performance.	1 to 8
VD Level Mode (Manual)	Display the threshold value display method of the quantization mode at manual acquisition.	Auto Threshold1 Auto Threshold2 Manual Threshold

Setting Item	Description of Setting	Setting Value
VD Level (Manual)	Set up the quantization level when acquiring manually.	0 to 255
VD Level (Auto)	Set up the quantization level when acquiring automatically.	0 to 255
Gate Size	Display the gate size to be used for tracking.	Small Medium Large
Tracking	The number of currently acquired targets is displayed in a range from 0 to the maximum TT display count.	-

18.10 Setting AIS/TT Filters

Select [Filter] in the classification pane.

Set an AIS/TT filter in the setting dialog of the edit pane.

By setting an AIS/TT filter, targets within the area can be displayed preferentially or only the inside of the area can be displayed.

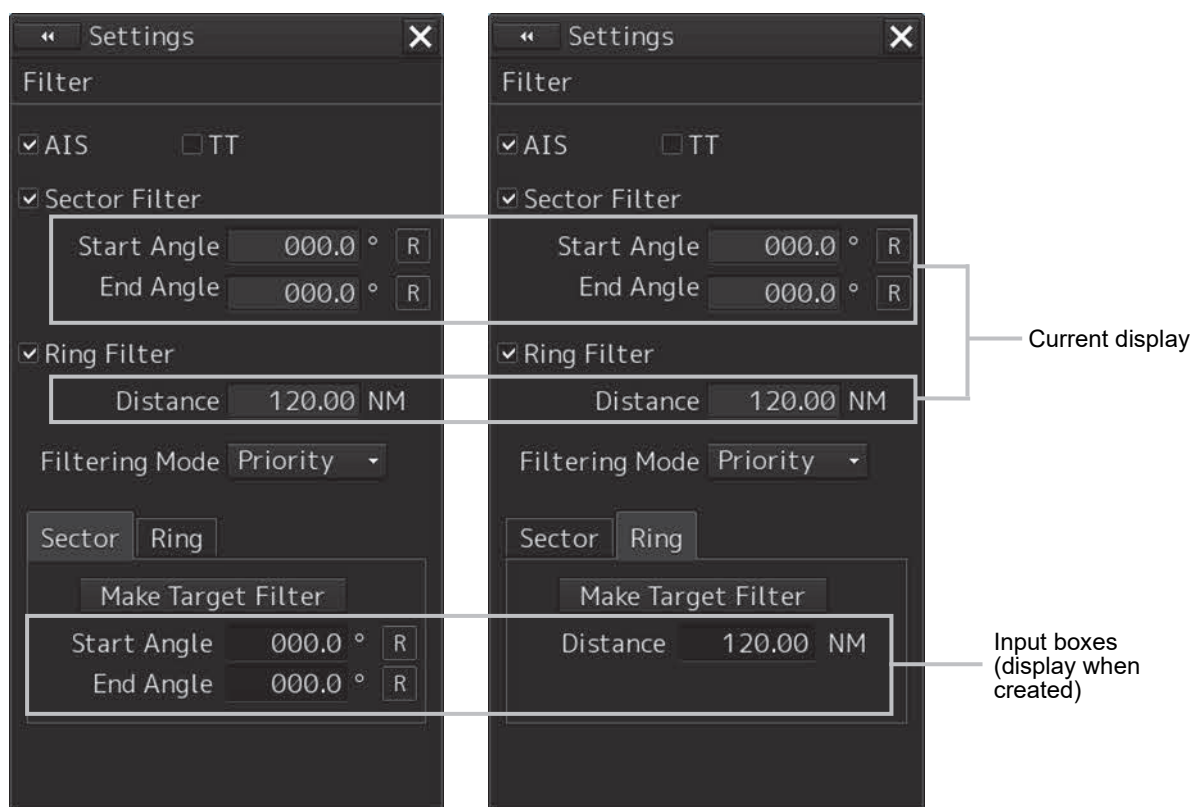

Setting Item	Description of Setting	Setting Value
AIS	When this is selected, filtering AIS target is performed in the operation mode being selected in Filtering mode.	To enable: Select. To disable: Clear.
TT	When this is selected, filtering external target is performed in the operation mode being selected in Filtering mode.	To enable: Select. To disable: Clear.
Sector Filter	When this is selected, the Sector Filter is displayed on the screen and filtering is performed in the operation mode being selected in Filtering mode.	To enable: Select. To disable: Clear.
Start Angle	Set up the starting angle of the Sector Filter. The angle value indicates the relative bearing based on the ship's heading as the reference. When entry is confirmed, the entered value takes effect immediately.	0.0 to 359.9°
End Angle	Set up the end angle of the Sector Filter. The angle value indicates the relative bearing based on the ship's heading as the reference. When entry is confirmed, the entered value takes effect immediately.	0.0 to 359.9°

Setting Item	Description of Setting	Setting Value
Ring Filter	When this is selected, the Ring Filter is displayed on the dialog box and filtering is performed in the operation mode being selected in Filtering mode.	To enable: Select. To disable: Clear.
Distance	Set up the distance of the Ring Filter. When entry is confirmed, the entered value takes effect immediately.	0.0 to 120.0 NM
Filtering Mode	Select an operation mode of the AIS/TT filter. Display: Targets cannot be displayed outside of the AIS/TT filter range. Priority: Priority is determined within the range of the AIS/TT filter and targets are displayed based on the priority.	Display Priority

Creating a filter in the dialog

Creating a Sector Filter

- 1** Click on the [Sector] tab.
- 2** Click on [Make Target Filter].
The button is highlighted and the cursor mode is set to the Make Target Filter mode.
- 3** Move the cursor, place it on the starting angle of the Sector filter you want to set up, and then click on it.
- 4** Move the cursor, place it on the end angle of the Sector filter you want to set up, and then click on it.

Creating a Ring Filter

- 1** Click on the [Ring] tab.
- 2** Click on [Make Target Filter].
The button is highlighted and the cursor mode is set to the Make Target Filter mode.
- 3** Move the cursor, place it on the distance of the Ring filter you want to set up, and then click on it.

Note

When the AZ function is ON, a distance smaller than the outer arc of AZ cannot be set for the Ring filter.

Memo

<Priority setting>

- The sleeping target in the AIS/TT filter has a higher priority than the sleeping target outside of the AIS/TT filter (preferentially displayed).

<AIS/TT Filter OFF>

- The sleeping target in the AIS/TT filter has the same priority as the sleeping target outside of the filter.

18.11 Setting the Target Track Function to ON/OFF

Select [Target Track] in the classification pane.

Set the target track function to ON/OFF in the setting dialog of the edit pane.

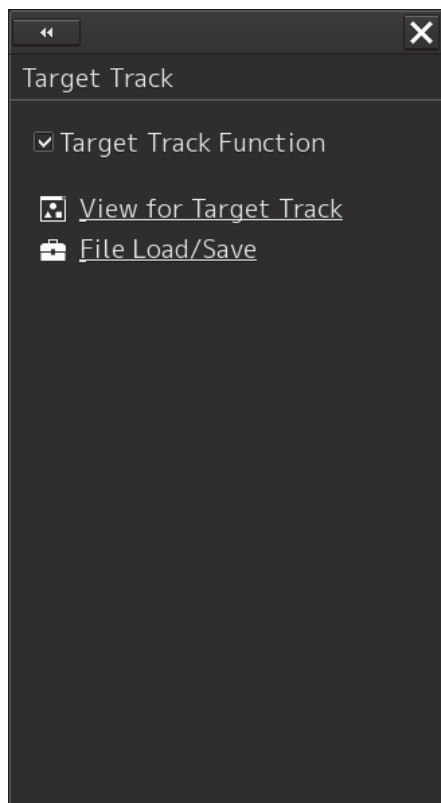

Setting Item	Description of Setting	Setting Value
Target Track Function	Turn On/Off the target track function.	To enable: Select. To disable: Clear.

18

Shortcuts

Click on any of the following shortcuts to display the related dialog box.

Shortcut	Settings Dialog Box
View for Target Track	[Target Track] dialog box
File Load/Save	[File Manager] dialog box

18.12 Setting Parameter Values at Route Plan Creation

Select [Route] in the classification pane.

Set various parameter values at route plan creation in the setting dialog of the edit pane.

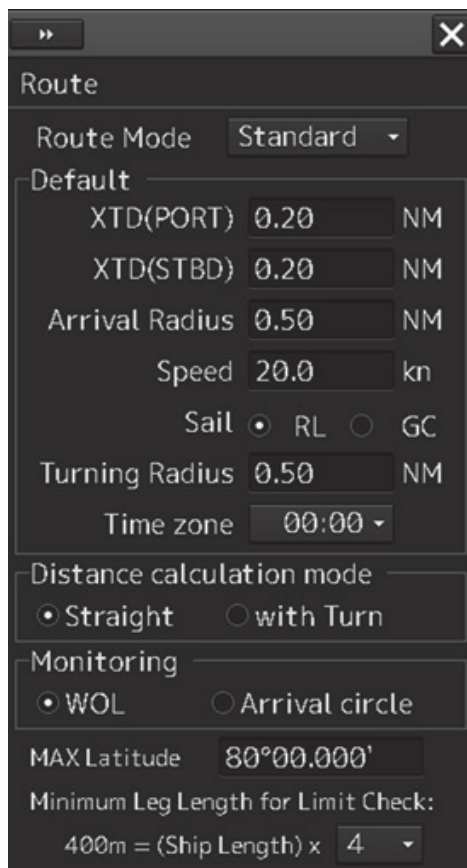

Set up the factory setting values for routes to be created during route planning.

Setting Item	Description of Setting	Setting Value
Route Mode	Set up the route display mode. Standard:The ordinary ECDIS route will be used. NMEA:NMEA destination will be used.	Standard NMEA
XTD (PORT)	Set up the cross track limit of the port side.	0.01 to 9.99 NM
XTD (STBD)	Set up the cross track limit of the starboard side.	0.01 to 9.99 NM
Arrival radius	Set up the radius of the WPT (waypoint) arrival circle.	0.01 to 9.99 NM
Speed	Set up the planned speed.	1.0 to 99.9 kn
Sail	Set up sailing (RL (Rhumb Line) or GC (Great Circle)).	RL GC
Turning Radius	Set up the turn radius.	0.10 to 9.99 NM
Time Zone	Set up the time zone.	-13:30 to +13:30

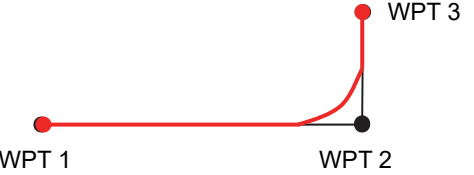
Setting Item	Description of Setting	Setting Value
Distance Calculation Mode	<p>Set up the calculation method of the distance between WPTs.</p> <p>Straight: Calculates the distance between WPTs linearly (red line).</p>  <p>With Turn: Calculates the distance between WPTs using a predicted route (red line).</p> 	Straight with Turn
Monitoring	<p>Set up the route monitoring method.</p> <p>Wheel-over Line: monitored by using Wheel-over line (WOL) along each WPT.</p> <p>Arrival Circle: monitored by using the arrival circle along each WPT.</p> <p>The setting will be changed according to the type of auto pilot during automatic sailing.</p>	Wheel-over Line, Arrival Circle
MAX Latitude	<p>Because a WPT cannot be entered at a latitude higher than the latitude you set up when planning a route, this threshold is used to check the latitude of the destination during active route reception. If the threshold value is abnormal, an active route will not be loaded even if it is received.</p> <p>When creating a GC leg, if a leg is positioned over the latitude you set up, the composite sailing will take effect automatically and the leg will be divided into three segments. (GC-RL-GC)</p>	30°00.000' to 85°00.000'
Minimum Leg Length for Limit Check	<p>Select a multiplier for determining the "Minimum Leg Length" which will be used for limit check.</p> <p>Minimum leg length = (Ship length) × Multiplier (τ multiplier)</p>	1, 2, 4, 6, 8

18.13 Setting Automatic Sailing Parameter Values

Select [Autosail] in the classification pane.

Set various parameter values relating to automatic sailing in the setting dialog of the edit pane.

Note

- Displayed when the automatic sailing option is attached.
- When PT900 is installed as auto pilot, [Autosail] is not displayed.

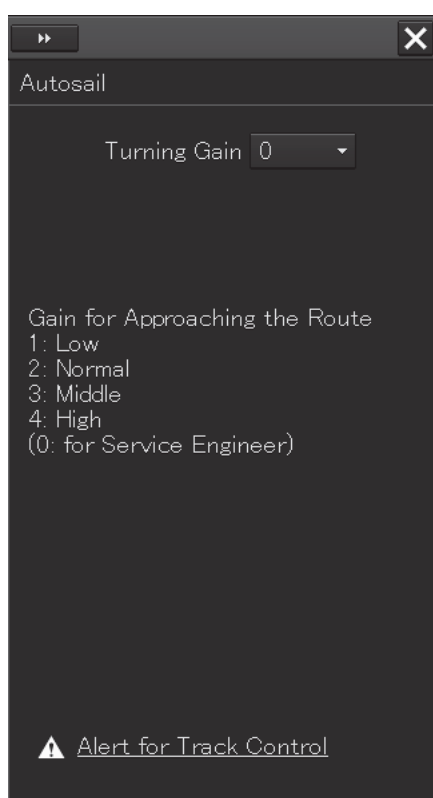

Example of screen display under the following conditions:

- Tokyo Keiki TCS Category C
- Tokyo Keiki TCS Category B (new system)

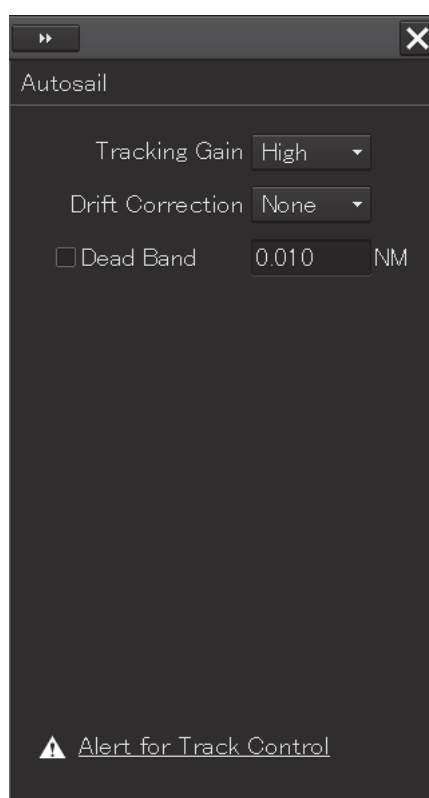

Example of screen display under the following conditions:

- Tokyo Keiki TCS Category B (old system)
- YDK TCS Category C

Setting Item	Description of Setting	Setting Value
Tracking Gain	<p>Set up the tracking gain. This can be set up even during automatic sailing.</p> <p>The tracking gain value specifies how quickly the ship will return to the original course when it has deviated from the course.</p> <p>You can select from three tracking gain settings of [High], [Middle] and [Low].</p> <p>For example, assume that the target gain value is being set to "16 deg./NM" and the own ship is positioned at 1 NM right of the tracking gain.</p> <p>In this case, specify the distance for the own ship to approach the target at an angle of 16°.</p> <p>If the distance between the own ship and the target course is shortened, this angle will also be reduced.</p> <p>When the own ship has reached the target course, the angle will be the same as WP1 viewed from 0 of a WPT, and the more the LD will be, the larger this angle will get.</p> <p>Note that you may lose the control of the helm depending on the tracking gain value, so be careful with the setting.</p>	<p>Low</p> <p>Middle</p> <p>High</p>
Drift Correction	<p>Set up the drift correction. This can be set up even during automatic sailing.</p> <p>When this is set to On (High/Middle/Low), control is performed considering the tide if the own ship's speed is 5 knots or faster.</p> <div data-bbox="494 1164 805 1299" data-label="Diagram"> </div> <p>None: Off (Drift correction will not be performed.)</p> <p>High: Drift correction will be performed. The drift correction value is equivalent to the tidal vector (100%).</p> <p>Middle: Drift correction will be performed. The drift correction value is 2/3 of the tidal vector.</p> <p>Low: Drift correction will be performed. The drift correction value is 1/3 of the tidal vector.</p>	<p>None</p> <p>High</p> <p>Middle</p> <p>Low</p>

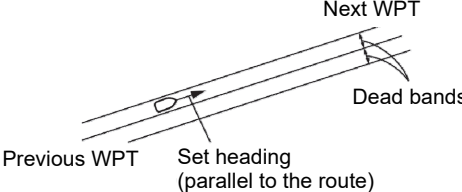
Setting Item	Description of Setting	Setting Value
Dead Band (On/Off)	<p>Set up On/Off of the dead band. This can be set up even during automatic sailing.</p> <p>To prevent yawing while navigation, it is necessary to provide dead bands at both sides of the current course.</p> <p>If the own ship is positioned within the dead band course, the course will be fixed at [Track Course]. For more details, see the following drawing.</p> 	<p>To enable: Select.</p> <p>To disable: Clear.</p>
Dead Band (setting value)	Specify the dead band value. This can be set up even during automatic sailing.	0.001 to 0.999 NM
Turning Gain	<p>Set up the turning gain. This can be set up even during automatic sailing.</p> <p>The turning gain represents how much the turning radius will be changed according to the XTD when changing the course.</p> <p>You can select the turning gain in a range from 0 to 4.</p> <ul style="list-style-type: none"> • 0: Changes the course using the planned radius without depending on the XTD during course change. • 1 to 4: Changes the turning radius according to the XTD during course change. (1 is the weakest gain and 4 is the strongest gain.) 	0 to 4
Display when the TCS is	<ul style="list-style-type: none"> • Tokyo Keiki TCS Category C • Tokyo Keiki TCS Category B (new system) 	

Shortcut

Click on the following shortcut to display the related dialog box.

Shortcut	Settings Dialog Box
Alert for Track Control	[Track Control] dialog box

18.14 Setting the Temporary Route Setting Values

Select [Temporary Route] in the classification pane.

In the setting dialog of the edit pane, perform the necessary setting relating to the temporary route.

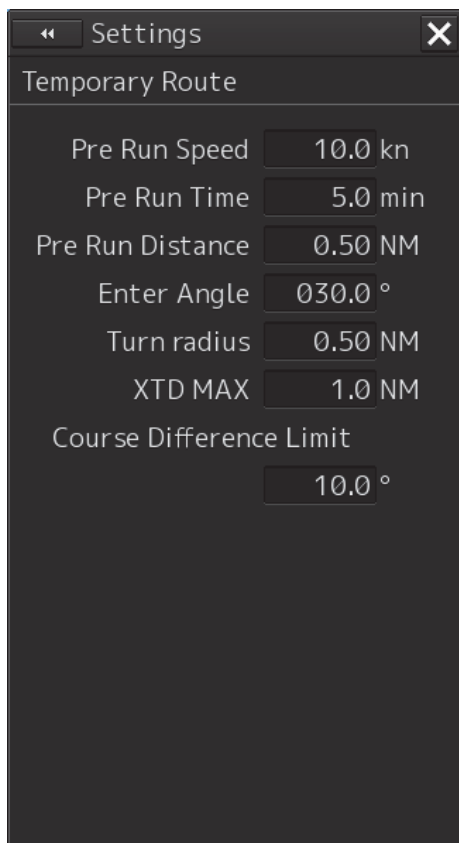

Before starting automatic sailing, move own ship along the leg.

Setting Item	Description of Setting	Setting Value
Pre Run Speed	Set a planned ship speed of the temporary route to calculate the minimum leg length.	0.0 to 99.9 kn
Pre Run Time	Set a planned time of the temporary route to calculate the minimum leg length.	1.0 to 30.0 min
Pre Run Distance	Set a planned distance of the temporary route.	0.10 to 9.99 NM
Enter Angle	Set an entrance angle of the temporary route.	30.0 to 90.0°
Turning Radius	Set an initial turn radius of the temporary route.	0.10 to 9.99 NM
Planned ROT	Set the predicted value of ROT(Rate of Turn). Calculated from Pre Run Speed and Turning Radius, when entering the value of Planned ROT, the value of Turning Radius is calculated and fluctuates.	It will be changed by the value of Pre Run Speed.
XTD MAX	Set the maximum XTD of the temporary route.	0.0 to 1.0 NM
Course Difference Limit	Set the difference of the leg bearing of the predicted course and ship's heading.	0.5 ~ 45.0°

Memo

The minimum leg length is expressed in the following formula.

Minimum leg length = (planned ship speed of the temporary route × planned time of the temporary route) + planned distance of the temporary route + reach

18.15 Setting Chart Operation

Note

The Deletion Mode (Chart Maintenance) is displayed on the ECDIS screen.
Others are displayed on the ECDIS mode only.

Select [Chart] in the classification pane.

Set chart operation in the setting dialog of the edit pane.

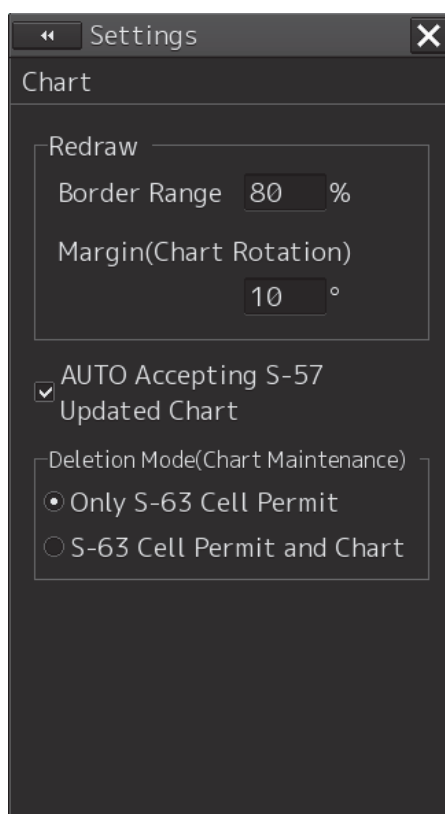

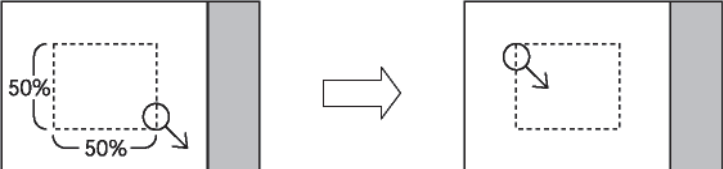
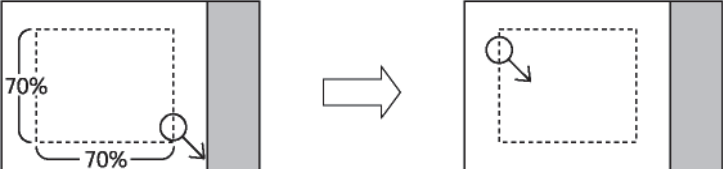
Setting Item	Description of Setting	Setting Value
Border Range	<p>Set up the range for the own ship in order to move the chart. This is displayed only on the ECDIS screen.</p> <ul style="list-style-type: none"> When the own ship is sailing in the direction of the arrow in the figure below.  <ul style="list-style-type: none"> If the border range you set up is 50%, the screen display switches when the own ship reaches a 50% area from an edge of the screen.  <ul style="list-style-type: none"> If the border range you set up is 70%, the screen display switches when own ship reaches the border range.  <p>While the ECDIS screen is displayed, the own ship display position is reset by switching RADAR Overlay from ON to OFF under the following conditions:</p> <ul style="list-style-type: none"> RADAR Overlay: ON Motion mode: TM Own ship position: Own ship is moving. Own ship display position: Edge of the chart display area (position beyond the [Settings] - [Chart-Border Range] setting) <p>This is because when RADAR Overlay is ON, the limit defined in the Radar standards is prioritized over the ECDIS display area limit.</p>	30 to 80 %
Margin (Chart Rotation)	<p>When head-up, if own ship turns at the angle specified here, the chart will also turn. For example, if the margin is set to 10°, the chart will turn when own ship turns 10° or more.</p>	0 to 90°

Setting Item	Description of Setting	Setting Value
AUTO Accepting S-57 Updated Chart	Set whether the chart is accepted automatically at completion of chart import.	Accepted automatically: Check Not accepted automatically: Not check
Deletion Mode(Char Maintenance)	Set the operation mode of the Delete button on the status screen in Chart Maintenance. Only S-63 Cell Permit: Deletes the license only when the Delete button is pressed. S-63 Cell Permit and Chart: Deletes the license and chart when the Delete button is pressed.	Only S-63 Cell Permit S-63 Cell Permit and Chart

Memo

The setting of Deletion Mode(Char Maintenance) is valid only under S-63 (ENC that requires the permit). Under S-57 (ENC that does not require the permit), the chart is also deleted regardless of this setting.

18.16 Setting Logbook

Select [Logbook] in the classification pane.

Set Logbook in the setting dialog of the edit pane (ECDIS screen only).

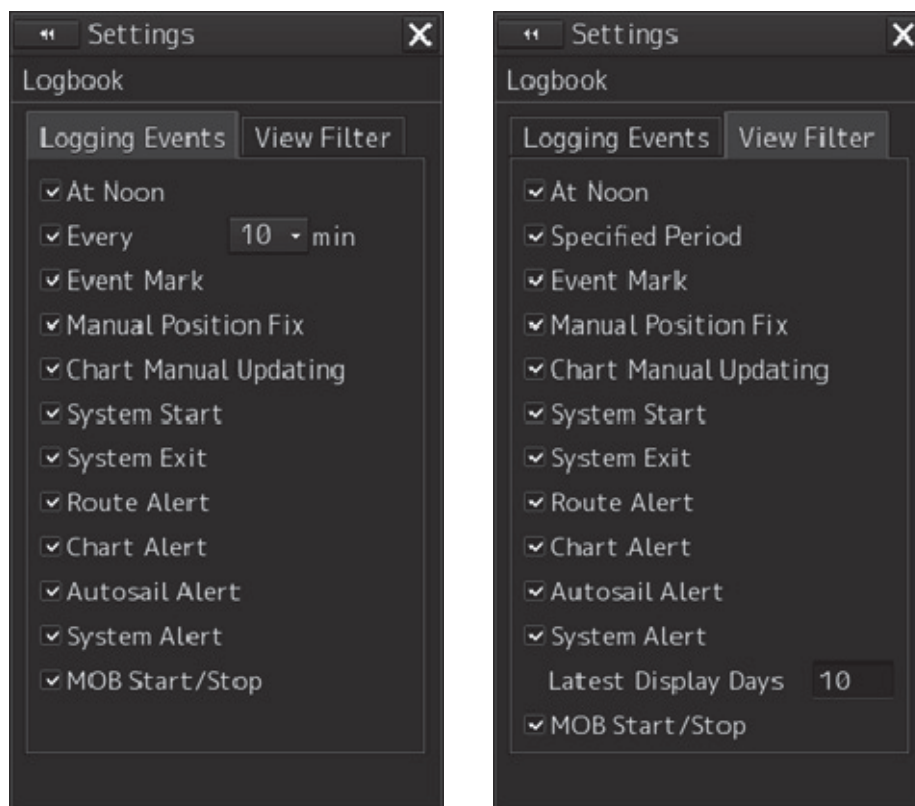

[Logging Events] tab

Setting Item	Description of Setting	Setting Value
At Noon	When this is selected, log data is saved at 12:00 (LMT).	To enable: Select. To disable: Clear.
Every ([Logging Events] tab)	When this is selected, log data is saved at the interval specified in the combo box.	<Check box> To enable: Select. To disable: Clear. <Selections in the combo box> 1/3/5/10/15/30/60 min
Event Mark	When this is selected, log data is saved when the EVENT button is pressed.	To enable: Select. To disable: Clear.
Manual Position Fix	When this is selected, the time, bearing, position, objects used during manual position fixing in cross bearing or running fix are saved.	To enable: Select. To disable: Clear.
Chart Manual Updating	When this is selected, log data is saved when the chart is manually updated.	To enable: Select. To disable: Clear.

Setting Item	Description of Setting	Setting Value
System Start	When this is selected, log data is saved when the system is started.	To enable: Select. To disable: Clear.
System Exit	When this is selected, log data is saved when the system is shut down.	To enable: Select. To disable: Clear.
Route Alert	When this is selected, log data is saved when a route-related alert is generated.	To enable: Select. To disable: Clear.
Chart Alert	When this is selected, log data is saved when a chart-related alert is generated.	To enable: Select. To disable: Clear.
Autosail Alert	When this is selected, log data is saved when an autosail-related alert is generated.	To enable: Select. To disable: Clear.
System Alert	When this is selected, log data is saved when a system-related alert is generated.	To enable: Select. To disable: Clear.
MOB Start/Stop	When this item is enabled, MOB start and MOB stop are recorded.	Enable: Check. Disable: Uncheck.

[View Filter] tab

Setting Item	Description of Setting	Setting Value
At noon	When this is selected, the events saved at 12:00 (LMT) are displayed in the list.	To enable: Select. To disable: Clear.
Specified Period	When this is selected, the events saved at the interval specified in [Logging] are displayed in the list.	To enable: Select. To disable: Clear.
Event Mark	When this is selected, the events saved when the EVENT button was pressed are displayed in the list.	To enable: Select. To disable: Clear.
Manual Position Fix	When this is selected, the events saved during manual position fixing in cross bearing or running fix are displayed in the list.	To enable: Select. To disable: Clear.
Chart Manual Updating	When this is selected, the events saved when the chart was manually updated are displayed in the list.	To enable: Select. To disable: Clear.
System Start	When this is selected, the events saved when the system was started are displayed in the list.	To enable: Select. To disable: Clear.
System Exit	When this is selected, the events saved when the system was shut down are displayed in the list.	To enable: Select. To disable: Clear.

Setting Item	Description of Setting	Setting Value
Route Alert	When this is selected, the events saved when a route-related alert was generated are displayed in the list.	To enable: Select. To disable: Clear.
Chart Alert	When this is selected, the events saved when a chart-related alert was generated are displayed in the list.	To enable: Select. To disable: Clear.
Autosail Alert	When this is selected, the events saved when an autosail-related alert was generated are displayed in the list.	To enable: Select. To disable: Clear.
System Alert	When this is selected, the events saved when a system-related alert was generated are displayed in the list.	To enable: Select. To disable: Clear.
Latest Display Days ()	The days on which the items saved in the Other event were specified are displayed in a range between 1 and 90.	1 to 90
MOB Start/Stop	When this item is enabled, MOB start and MOB stop are displayed.	Enable: Check. Disable: Uncheck.

18.17 Setting NAVTEX

Select [NAVTEX] in the classification pane.

Set the display method for the NATVEX message that is displayed by clicking on the [NAVTEX] button on the information reference window in the editing pane setting dialog.

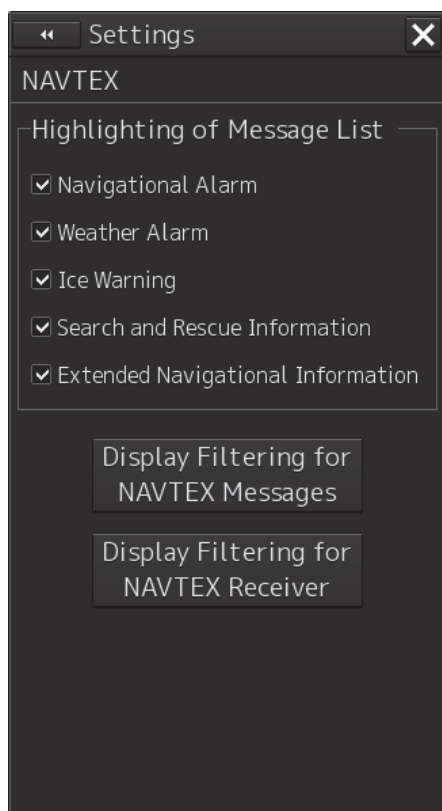

Setting item	Setting contents	Setting value
Navigational Alarm	Set highlighted display of the navigation alarm. When the item is enabled, the message is displayed with black characters on the white background.	Enable: Check Disable: Uncheck
Weather Alarm	Set highlighted display of the weather alarm. When the item is enabled, the message is displayed with black characters on the white background.	Enable: Check Disable: Uncheck
Ice Warning	Set highlighted display of the Ice Warning. When the item is enabled, the message is displayed with black characters on the white background.	Enable: Check Disable: Uncheck
Search and Rescue Information	Set highlighted display of the search and rescue information. When the item is enabled, the message is displayed with black characters on the white background.	Enable: Check Disable: Uncheck

Extended Navigational Information	Set highlighted display of the navigation alarm supplementary information. When the item is enabled, the message is displayed with black characters on the yellow background.	Enable: Check Disable: Uncheck
[Display Filtering for NAVTEX Messages] button	When this button is clicked on, the [Display Filtering for NAVTEX Messages] dialog is opened. For details, refer to “Displaying only the NAVTEX messages that satisfy a specific condition”.	-
Display Filtering for NAVTEX Receiver] button	When this button is clicked on, the [Display Filtering for NAVTEX Receiver] dialog is opened. For details, refer to “Receiving only the NAVTEX messages that satisfy a specific condition”.	

Displaying only the NAVTEX messages that satisfy a specific condition

When the [Display Filtering for NAVTEX Messages] button is clicked on, the [Display Filtering for NAVTEX Messages] dialog is displayed.

In this dialog, NAVTEX messages to be displayed can be filtered.

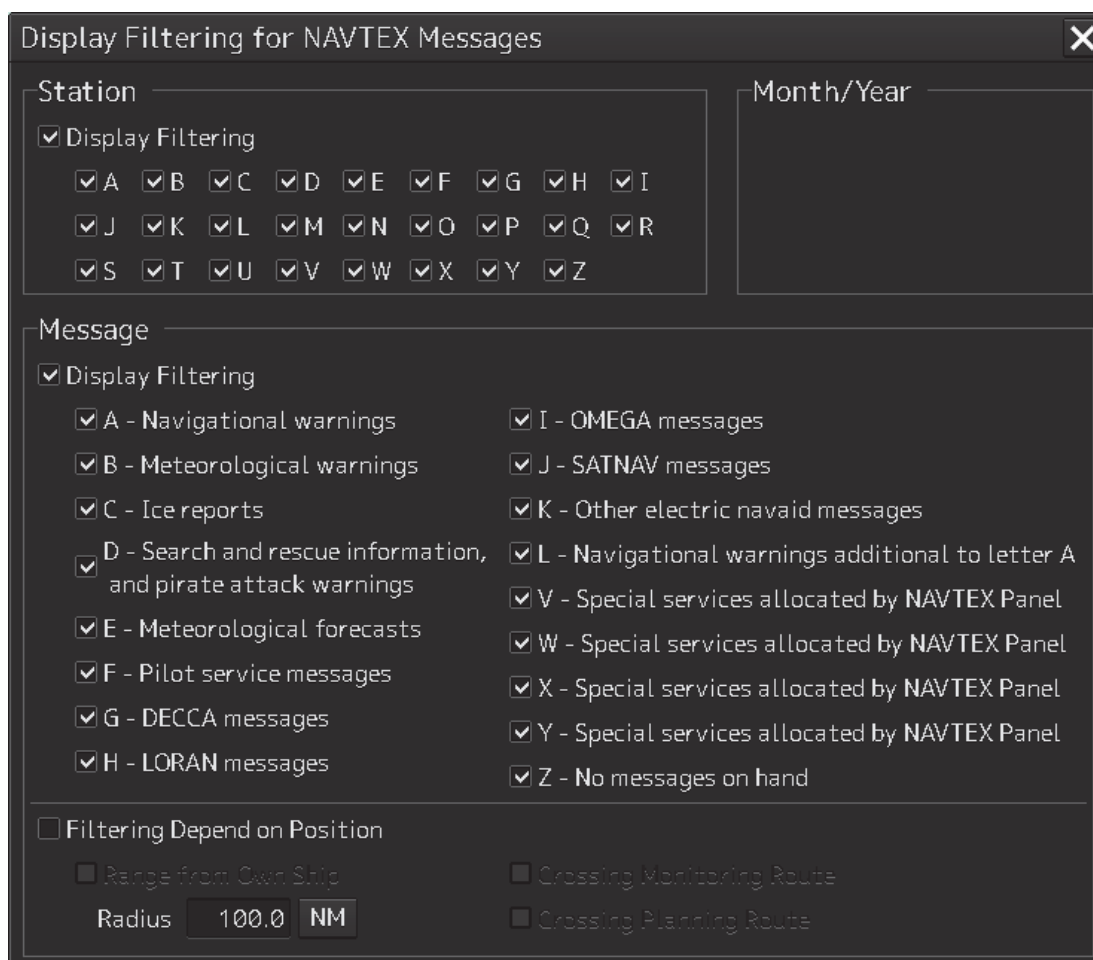

Setting item	Setting contents	Setting value
Station – Display Filtering	Select a base station from which messages are to be displayed. By checking the Display Filtering check box, the check box of each base station can be checked. Select a required base station by checking the check box.	Enable: Check Disable: Uncheck
Month/Year	Only the messages that are received on the selected month/year are displayed. Select a required month/year by checking the check box.	Enable: Check Disable: Uncheck
Message – Display Filtering	Select a type of the messages to be displayed. By checking the Display Filtering check box, the check boxes of message types can be checked. Select a required message type by checking the check box.	Enable: Check Disable: Uncheck
Message – Filtering Depend on Position	Whether to perform display filtering by position is selected. By checking the Filtering Depend on Position check box, you can select detailed filtering conditions.	Enable: Check Disable: Uncheck
Message – Filtering Depend on Position – Range from Own Ship	Choose whether to perform display filtering by the distance from the ship's position. When checked, filtering is performed by the distance from the ship's position to the set value of the Radius input box.	Enable: Check Disable: Uncheck
Message – Filtering Depend on Position – Radius	Enter the distance of the filter from your ship. Click the NM / min button to switch the unit.	0.1~300 NM 1.0~30.0 min
Message – Filtering Depend on Position – Crossing Monitoring Route	Choose whether to perform display filtering by route selected during route monitoring. When checked, filtering is carried out by the route monitoring range.	Enable: Check Disable: Uncheck
Message – Filtering Depend on Position – Crossing Planning Route	Choose whether to perform display filtering by route selected during route planning. When checked, filtering is carried out by the route planning range.	Enable: Check Disable: Uncheck

Receiving only the NAVTEX messages that satisfy a specific condition

Click the Display Filtering for NAVTEX Receiver button to open the "Display Filtering for NAVTEX Receiver" (NAVTEX Message Receive Filtering) dialog.

In this dialog, you can filter (narrow down) the displayed NAVTEX message.

- 1 Click the Display Filtering for NAVTEX Receiver button.
A dialog box labeled "Waiting for a response from the NAVTEX receiver" is displayed.

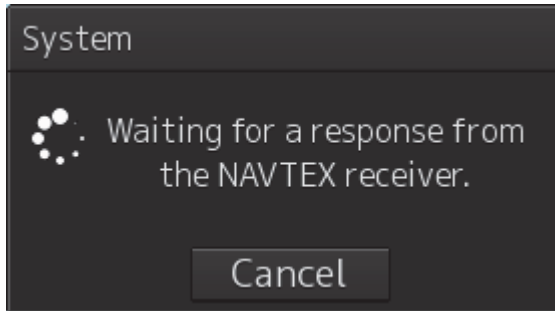

- 2 When the NAVTEX receiver is connected, open the "Display Filtering for NAVTEX Receiver" dialog (NAVTEX Message Receive Filtering) dialog.

If there is no response from the NAVTEX receiver, a popup with "No response from NAVTEX receiver" is displayed. When this popup is displayed, check the connection with the NAVTEX receiver.

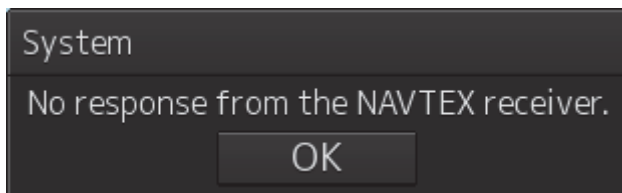

Setting item	Setting contents	Setting value
FREQUENCY	Displaying NAVTEX frequency.	RX(518 KHz)
Setting Type	Select the setting type of the NAVTEX receiver.	RX Station / Message Type Setting Printer Message Output Setting INS Message Output Setting
Station – Display Filtering	Choose from which base station to receive and output messages. If you check the Display Filtering check box, you can check the check box of each base station. Next, check the check box of the desired base station and select it.	Enable: Check Disable: Uncheck

Setting item	Setting contents	Setting value
Month/Year	Only messages received at the selected year / month are displayed. Check the check box of the desired year and month and select it.	Enable: Check Disable: Uncheck
Message – Display Filtering	Choose which type of message you want to display. If you check the Display Filtering checkbox, you can check the checkbox of message type. Next, select the check box of the kind of the desired message and select it.	Enable: Check Disable: Uncheck

18.18 Setting Navigation Equipment

Select [General] in the classification pane.

Set navigation equipment in the setting dialog of the edit pane.

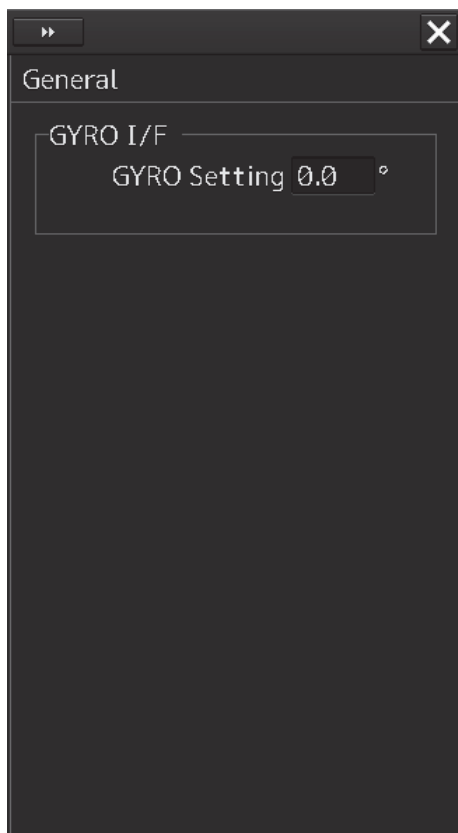

Setting Item	Description of Setting	Setting Value
GYRO Setting	Enter the initial value of the gyro.	0.0 to 359.9°

18.19 Setting Colors and Brightness

Select [Colour and Brightness] in the classification pane.

Set the colour and the brightness of the display contents in the setting dialog of the edit pane.



[1] [Def.] (default value) button

When this button is clicked on, all the setting items of the mode that is selected on the [Day/Night] combo box are reset to the default values.

Setting Item	Description of Setting	Setting Value
Day/Night	Set up the colour of the dialog box itself. Select the chart display colours from the three types of Day1, Day3 and Night when the ARCS is used.	Day1 [default] Day2 Day3 Dusk Night

Setting Item	Description of Setting	Setting Value
[Display Color] tab		
Outer PPI/Dialog	Set up the colour outside the PPI. The label changes depending on the screen to be called. The label will be Outer PPI/Dialog for the RADAR screen, and Dialog for others.	Dark [default] Black
Inner PPI	Set up the colour inside the PPI. This item is displayed only on the RADAR screen.	Blue Dark Blue Black [default]
Character	Set up the text colour.	White [default] Green
RADAR Video	Set up the colour of radar video. Displays on the ECDIS screen which has a PADAR screen and PADAR display function.	Yellow [default] Green Orange Purple Dark Red
RADAR Trails(Time)	Set up the colour of radar trails. This item is displayed only on the RADAR screen.	White Blue Cyan [default] Green
Target Symbol	Set up the colour of the target symbol.	White/Black* ¹ Cyan Green [default] Orange
Range Rings	Set up the colour of range rings.	White/Black* ¹ Cyan [default] Green Orange
EBL1/VRM1/PI	Set up the colour of EBL1, VRM1 and parallel index lines.	White/Gray* ¹ Cyan Green Orange [default]
EBL2/VRM2	Set up the colour of EBL2 and VRM2.	White/Gray* ¹ [default] Cyan Green Orange
Own Symbol/HL/Vector	Set up the colour of own ship symbol, heading line and vector.	White/Black* ¹ [default] Cyan Green Orange

Setting Item	Description of Setting	Setting Value
ALL GPS Buoy	Set up the colour of all GPS Buoy symbols. Set up the same colour for all GPS buoy symbols.	White/Black*1 [default] Gray /Amber /Magenta /Blue /Cyan /Green /Yellow /Orange /Dark Red
Individual	Select a colour for each GPS buoy. Set up the GPS Buoy 1 to 10, Other respectively.	White/Black/Gray /Amber /Magenta /Blue /Cyan /Green /Yellow /Orange /Dark Red
[Brightness] tab		
Character	Set up the text brilliance.	Level1(Dark) [default of Day 3] Level2 [default of Day 2, Dusk] Level3 [default of Day 1] Level4(Light) [default of Night]
RADAR Video	Set up the brilliance of radar video.	Level1(Dark) Level2 Level3 Level4(Light) [default]
RADAR Trails	Set the brightness of the radar image trail. Displayed on the RADAR screen only.	Level1(Dark) Level2 Level3 Level4(Light) [default]
Target Symbol	Set up the brilliance of the target symbol.	Level0(Dark) Level1 Level2 Level3 [default of Day3/Dusk/Night] Level4(Light) [default of Day1/2]
Range Rings	Set up the brilliance of range rings.	Level1(Dark) Level2 [default of Night] Level3 [default of DAY3/Dusk] Level4(Light) [default of Day1/2]
EBL/VRM/PI	Set up the brilliance of EBL, VRM and parallel index lines.	Level1(Dark) Level2 Level3 [default of DAY3/Dusk/Night] Level4(Light) [default of Day1/2]
Own Symbol/HL/Vector	Set up the brilliance of own ship symbol, heading line and vector.	Level1(Dark) Level2 Level3 [default of DAY3/Dusk/Night] Level4(Light) [default of Day1/2]

Setting Item	Description of Setting	Setting Value
Panel	Set the brightness of the operation unit.	Off Level1(Dark) [default of Dusk/Night] Level2 [default of Day3] Level3 [default of Day2] Level4(Light) [default of Day1]
Display	Set the value that is input in the box for the brightness of the display unit.	0 to 100 ²

*1: Under either of the following conditions in the ECDIS task, Black or Gray can be selected instead of White.

- ENC is displayed while [Day/Night] is set to Day1 or Day2.
- ARCS is displayed while [Day/Night] is set to Day.

*2: The brightness default values are as follows.

26inch screen(NWZ-208)	19inch screen(NWZ-207)	19inch screen(NWZ-214)
Day1/Day2/Day3: 67	Day1/Day2/Day3: 42	Day1/Day2/Day3: 70
Dusk: 60	Dusk: 20	Dusk: 62
Night: 11	Night: 4	Night: 10

(2) Next button

It is displayed when the GPS buoy is available.

When you click the second page is displayed, you can set the color of the GPS buoy.

If it is disabled, it will be hidden.

18.20 Setting Sounds

Select [Sounds] in the classification pane.

Set the volumes of the operation sound and operation error sound and alarm melody in the setting dialog of the edit pane.

When the volume or melody is changed, the selected volume or melody is played back, enabling the user to set while listening to the sound.

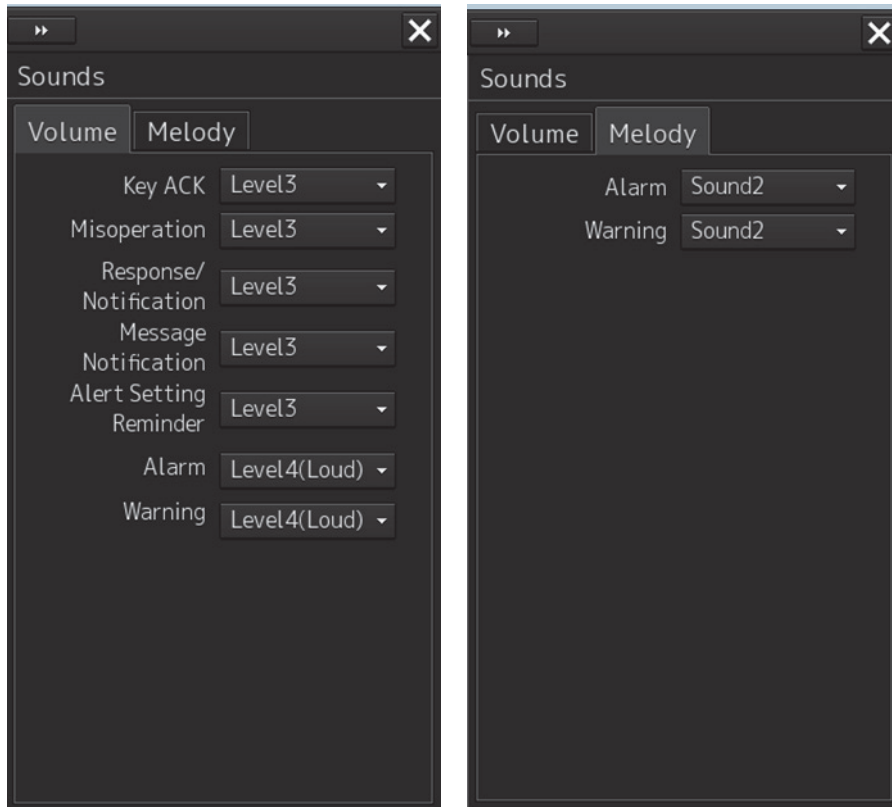

Setting item	Setting contents	Setting value
[Volume] tab		
Key ACK	Set the volume of the sound emitted when the key is pressed.	Off Level1(Soft) Level2 Level3 [Default] Level4(Loud)
Misoperation	Set the volume of the operation error sound.	Off Level1(Soft) Level2 Level3 [Default] Level4(Loud)
Response/Notification	Set the volume of the control response sound to external equipment and control completion notification sound (including the interswitch control) from external equipment.	Off Level1(Soft) Level2 Level3 [Default] Level4(Loud)
Message Notification	Set the volume of the message notification sound.	Off Level1(Soft) Level2 Level3 [Default] Level4(Loud)
Alert Setting Reminder	Set the volume of the sound notifying that the alarm condition has not been set.	Off Level1(Soft) Level2 Level3 [Default] Level4(Loud)
Alarm	Set the volume of the alarm sound.*1	Level4(Loud)
Warning	Set the volume of the warning sound.*1	Level4(Loud)
[Melody] tab		
Alarm	Set the melody of the alarm.	Sound1 Sound2[Default] Sound3 Sound4
Warning	Set up the melody of Warning.	Sound1 Sound2[Default] Sound3 Sound4

*1 For these volumes, only Level 4 (Loud) is able to be selected.

18.21 Setting Key Assignment

Select [Key Assignment] in the classification pane.

Set the keys in the operation unit and the function assigned to the [MULTI] dial in the setting dialog of the edit pane.

Only the items whose functions are available on the task screen are displayed on the screen.

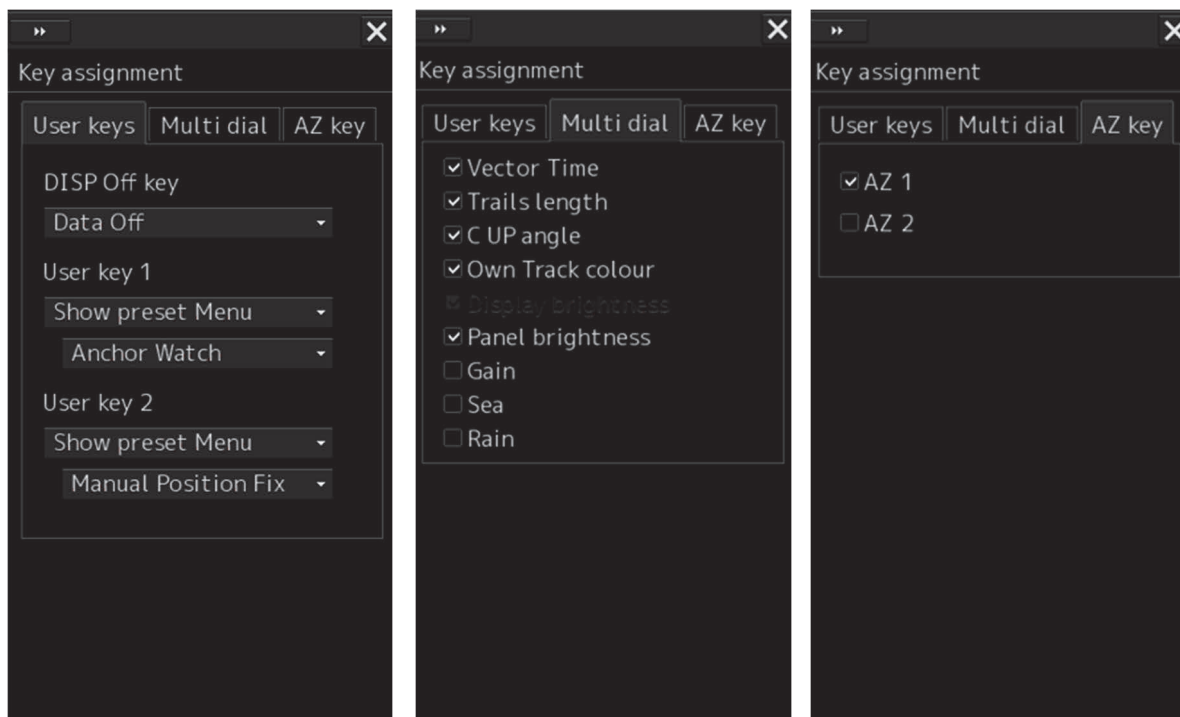

The [User Keys] and [AZ Key] tabs are displayed only when the optional operation unit is installed.

Setting Item	Description of Setting	Setting Value
[User Keys] tab		
DISP Off Key	Select a function to assign to the DISP Off key on the operation unit. [DISP Off Key] is displayed only when the optional operation unit is installed. It will be displayed neither on the CONNIG screen nor on the CAM screen.	Data Off HL Off
User Key 1	Select a function to assign to the [USER1] key on the operation unit. [User Key 1] is displayed only when the optional operation unit is installed.	Show Preset Menu Zoom Capture Screen Show Chart Acquire Cancel TT

Setting Item	Description of Setting	Setting Value
User Key 2	Select a function to assign to the [USER2] key on the operation unit. [User Key 2] is displayed only when the optional operation unit is installed.	Show Preset Menu Zoom Capture Screen Show Chart Acquire Cancel TT

Below is a list of functions that can be assigned to User Keys.

Function name	Function description
Show Preset Menu	The screen registered separately is displayed.
Zoom	Turn Zoom function on / off.
Capture Screen	Get screen capture.
Show Chart	Turn chart display on / off.
Acquire	Capturing manually under the cursor.
Cancel TT	Cancel (delete) the TT under the cursor. By pressing and holding for more than 5 seconds, all TTs are canceled.

Below is a list of screens that can be assigned to Show Preset Menu.

Screen name
Route Monitoring
Anchor Watch
Manual Position Fix
View - Option
Alert
Settings

Setting Item	Description of Setting	Setting Value
[Multi Dial] tab		
Vector Time	When this is selected, the vector length setup function will be manipulated with the [MULTI] control. This item is displayed on both the RADAR screen and the ECDIS screen.	To enable: Select. To disable: Clear.
Trails Length	When this is selected, the radar trail length setup function will be manipulated with the [MULTI] control. This item is displayed on the RADAR screen.	To enable: Select. To disable: Clear.
C UP Angle	When this is selected, the course adjustment function in the course-up mode will be manipulated with the [MULTI] control. This item is displayed on both the RADAR screen and the ECDIS screen.	To enable: Select. To disable: Clear.
Own Track colour	When this is selected, the own ship track colour switch function will be manipulated with the [MULTI] control. This item is displayed on both the RADAR screen and the ECDIS screen.	To enable: Select. To disable: Clear.
Manual Tune	When this is selected, the manual tuning function will be manipulated with the [MULTI] control. This RADAR screen items are displayed. This item is not displayed in the Slave (sub-display) mode, however.	To enable: Select. To disable: Clear.
Display Brightness	When this is selected, the display brightness adjustment function will be manipulated with the [MULTI] control. It cannot be changed since power is always on.	Always enabled.
Panel Brightness	When this is selected, the operation unit brightness adjustment function will be manipulated with the [MULTI] control. This item is always displayed.	To enable: Select. To disable: Clear.
Gain	When this is selected, the gain adjustment function will be manipulated with the [MULTI] control. When the RADAR function can be used, the item will be displayed.	To enable: Select. To disable: Clear.
Sea	When this is selected, the sea adjustment function will be manipulated with the [MULTI] control. When the RADAR function can be used, the item will be displayed.	To enable: Select. To disable: Clear.
Rain	When this is selected, the rain adjustment function will be manipulated with the [MULTI] control. When the RADAR function can be used, the item will be displayed.	To enable: Select. To disable: Clear.

Setting Item	Description of Setting	Setting Value
[AZ Key] tab		
AZ 1	When this is selected, AZ1 can be turned On/Off by pressing the [AZ] key. All checked items can be turned On/Off at once by pressing the [AZ] key.	To enable: Select. To disable: Clear.
AZ 2	When this is selected, AZ2 can be turned On/Off by pressing the [AZ] key. All checked items can be turned On/Off at once by pressing the [AZ] key.	To enable: Select. To disable: Clear.

18.22 Setting Preferences Information

Select [Preferences] in the classification pane.

The main operation/setting information relating to each task of RADAR and ECDIS can be stored and called collectively.

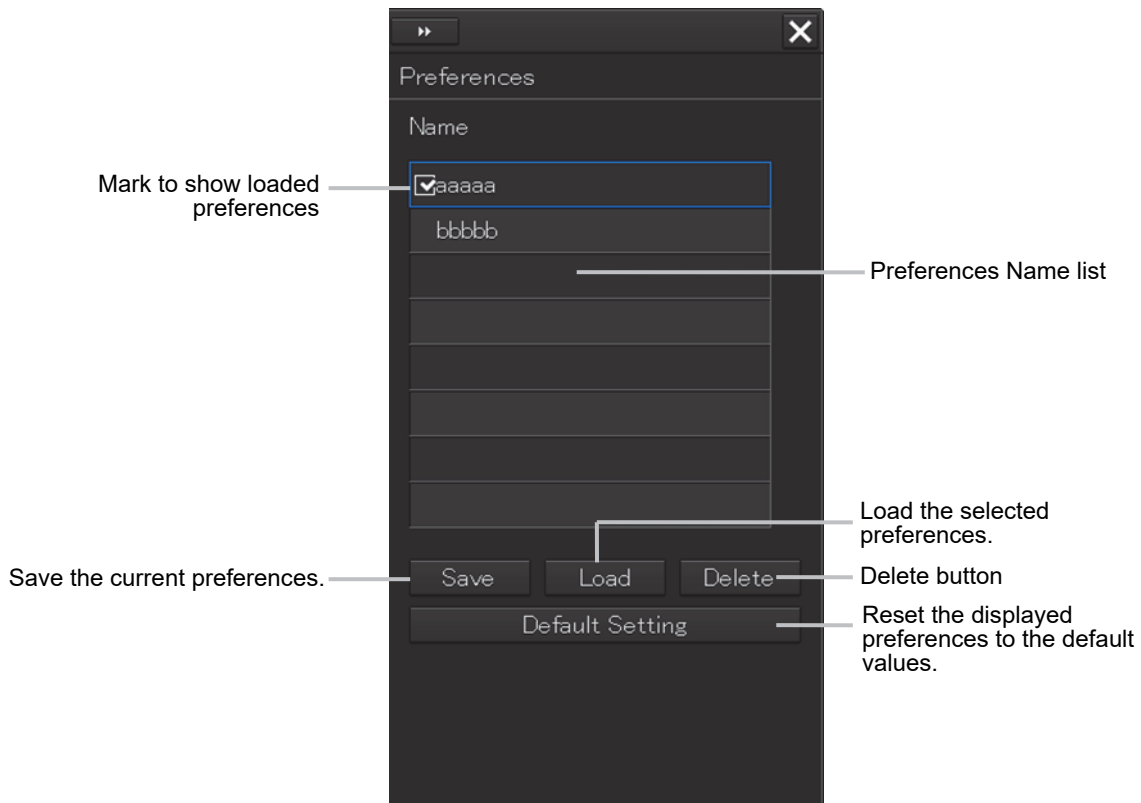

A maximum of 10 preferences names are displayed in the Preferences Name list. If all the file name characters do not fit in the display area, the remaining file name characters will be displayed with an abbreviation symbol (...).

To save a preferences

1 Click on the [Save] button.

The confirmation dialog box appears.

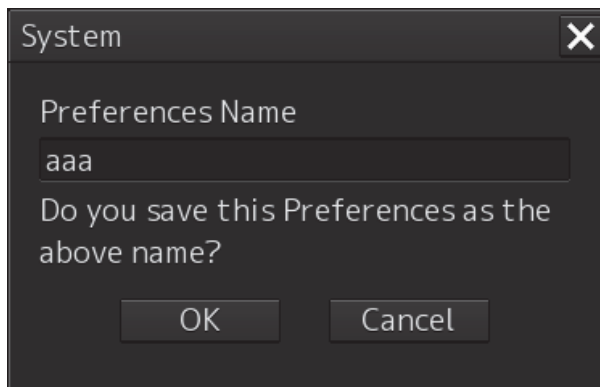

2 Enter a preferences name, and then click on the [OK] button.

The current preferences are saved.

A maximum of 64 characters can be entered for a file name. If all the file name characters do not fit in the display area, the remaining file name characters will be displayed with an abbreviation symbol (...).

To cancel saving, click on the [Cancel] button.

When saving is completed, an item is added to a blank line in the Preferences Name list.

To load preferences

1 Select the name of the preferences you want to load, and then click on the [Load] button.

The confirmation dialog box appears.

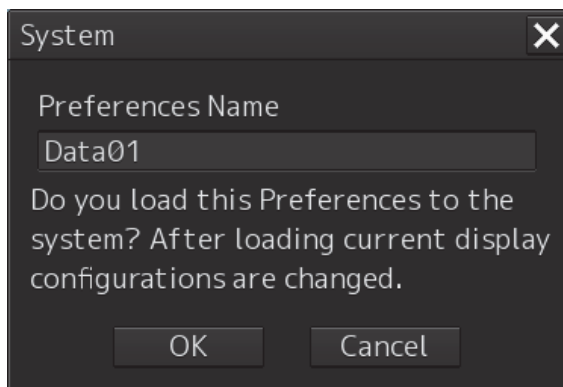

2 Click on the [OK] button.

The selected preferences are loaded.

A maximum of 64 characters can be entered for a file name. If all the file name characters do not fit in the display area, the remaining file name characters will be displayed with an abbreviation symbol (...).

To cancel loading, click on the [Cancel] button.

To delete preferences

- 1 Select the name of the preferences you want to delete, and then click on the [Delete] button.

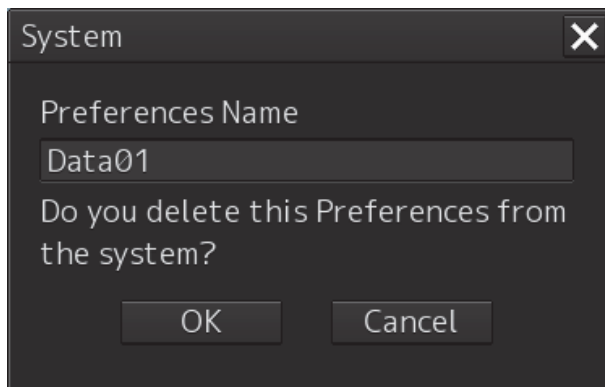

The confirmation dialog box appears. A maximum of 64 characters can be entered for a file name. If all the file name characters do not fit in the display area, the remaining file name characters will be displayed with an abbreviation symbol (...).

- 2 Click on the [OK] button.

The selected preferences are deleted.

To cancel deleting, click on the [Cancel] button.

To set up default display

- 1 Click on the [Default Setting] button.

The confirmation dialog box appears.

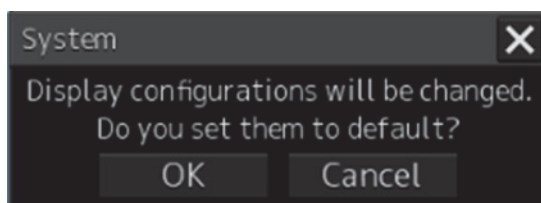

- 2 Click on the [OK] button.

The display configurations are changed to the default values.

To cancel changing, click on the [Cancel] button.

Items of preferences and default display configurations

The items of preferences and default display configurations are shown in the tables below.

Task "Route monitoring"

Item saved	Preferences save target		Factory setting value, value and action when Set Default button is pressed
	Location	Item	
Display category	ECDIS screen - Chart Information Area	Display category	Standard Display
Range	ECDIS screen - Chart Information Area	Either selection scale or selection range	Range 3 NM
Orientation	ECDIS screen - Chart Information Area	<ul style="list-style-type: none"> • Motion mode • Bearing mode 	True motion North-up TM reset value
position sensor	Common screen - Own Ship Information or Maintenance screen - Sensor Selection	Position source	Continuation
Past track	View - Options - Own Track (For ECDIS)	Past Track display On/Off Plot Color Track Period Time Label display On/Off Time Label Interval Past Position display On/Off Past Position Interval	Past Track display On/Off: On Plot Color: White (Black) *1 Track Period: 12h Time Label display On/Off: Off Time Label Interval: 30min Past Position display On/Off: Off Past Position Interval: 0.5min
Look-ahead time	Alert - Look-ahead	Area(Rectangle) function On/Off Rectangle Length value Rectangle Length unit Rectangle Width value Area(Sector) function On/Off Sector Width value	Area(Rectangle) function On/Off: On Rectangle Length value: 6min Rectangle Length unit: min Rectangle Width value: 65.6m Area(Sector) function On/Off: On Sector Width value: 45.0°
Specail Condition Area	Alert — Specail Condition Area	Priority	Priority: Caution
Repetition of UNACK Warning	Alert — CAM	Repetition of UNACK Warning	Time Limit: 60s
Area Boundary	View - Options - Chart Common	Area boundary	Plain

Item saved	Preferences save target		Factory setting value, value and action when Set Default button is pressed
	Location	Item	
Depth	View - Options - Chart Common	<ul style="list-style-type: none"> • Safety Depth • Safety Contour *2 • Four shades • Shallow Pattern • Shallow Water Dangers 	<ul style="list-style-type: none"> • Safety Depth: Continuation • Safety Contour: Continuation • Four shades: Off • Shallow Pattern: Off • Shallow Water Dangers: On
Chart Symbol	View - Options - Chart Common	<ul style="list-style-type: none"> • Chart Symbol • Full Light Line • Consider Scale Minimum 	<ul style="list-style-type: none"> • Chart Symbol: Paper Chart • Full Light Line: Off • Consider Scale Minimum: Off
Redraw	Setting —Chart	<ul style="list-style-type: none"> • Border Range 	<ul style="list-style-type: none"> • Border Range:80
Display of charts	View - Options - Chart Display (ECDIS)	<p>View1</p> <ul style="list-style-type: none"> • Chart Type • Text Size • Group Layer • Layer (Each item) <p>• Text (Each item)</p> <p>View2</p> <ul style="list-style-type: none"> • Text Size • Group Layer • Layer (Each item) • Text (Each item) 	<p>View1</p> <ul style="list-style-type: none"> • Chart Type: Remain • Text Size: 5 • Group Layer: On • Layer:[S]Unknown is On, Other objects below are Off: [A]Accuracy [A]Contour label [A]Highlight date dependent [A]Highlight info [A]Highlight document [-]Update Review [A]Nautical publication information • Text: National Language is Remain, Important text is On, Another objects are Off <p>View2</p> <ul style="list-style-type: none"> • Each item: same setting as View 1

Item saved	Preferences save target		Factory setting value, value and action when Set Default button is pressed
	Location	Item	
Unit	View —Options—Unit	<ul style="list-style-type: none"> • Current Speed • Wind Speed • Depth 	<ul style="list-style-type: none"> • Current Speed: Kn • Wind Speed: Kn • Depth: m
Own Ship	View —Options—Own Ship	<ul style="list-style-type: none"> • Sea stabilized vector • Type • Time 	<ul style="list-style-type: none"> • Sea stabilized vector: On • Type: Simplified Symbol • Time: 6min
Sub Information Area	View —Options—Control	<ul style="list-style-type: none"> • Show Sub Information Window 	<ul style="list-style-type: none"> • Show Sub Information Window: Off
AIO / T&P	View —Options—AIO / T&P	<ul style="list-style-type: none"> • All AIO Object • All T&P Object 	<ul style="list-style-type: none"> • All AIO Object: Off • All T&P Object: Off
Chart	Chart —Date Dependent View	<ul style="list-style-type: none"> • Enable Date Dependent View 	<ul style="list-style-type: none"> • Enable Date Dependent View: Off
Dangerous objects highlight	ECDIS display	<ul style="list-style-type: none"> • Chart drawing • (Dangerous objects highlight) 	<ul style="list-style-type: none"> • Chart drawing • (Dangerous objects highlight): On
		<ul style="list-style-type: none"> • Crossing Safety Contour 	<ul style="list-style-type: none"> • Crossing Safety Contour:On
		<ul style="list-style-type: none"> • Navigational Hazards 	<ul style="list-style-type: none"> • Navigational Hazards:On
		<ul style="list-style-type: none"> • Prohibited Areas and Areas with Special Conditions 	<ul style="list-style-type: none"> • Prohibited Areas and Areas with Special Conditions:On
Target past position	View —Options—Own Track	<ul style="list-style-type: none"> • Other shipping routes 	<ul style="list-style-type: none"> • Other shipping routes: Off
Settings for Route Planning	Settings—Route	<ul style="list-style-type: none"> • XTD(PORT) • XTD(STBD) • Max Latitude 	<ul style="list-style-type: none"> • Remain • Remain • Max Latitude: 85°
Brightness	Settings—General—Color and Broghtness—Brightness	<ul style="list-style-type: none"> • Display 	<ul style="list-style-type: none"> • Day1/2/3: 67 • Dusk: 60 • Night: 11
Chart Auto Acception	Settings—Chart	<ul style="list-style-type: none"> • AUTO Accepting S-57 Updated Chart 	<ul style="list-style-type: none"> • Off
Vector(T) length input box	ECDIS—Bottom bar	<ul style="list-style-type: none"> • Vector(T) 	<ul style="list-style-type: none"> • 6min
Cursor	ECDIS—Cursor Readout	<ul style="list-style-type: none"> • Distance unit 	<ul style="list-style-type: none"> • Distance unit: NM
MOB	ECDIS —Right Toolbar —MOB	<ul style="list-style-type: none"> • Distance unit 	<ul style="list-style-type: none"> • Distance unit: NM

Item saved	Preferences save target		Factory setting value, value and action when Set Default button is pressed
	Location	Item	
NAVTEX filter	Display Filtering for NAVTEX Messages —Position group	<ul style="list-style-type: none"> • Station—Display Filtering • Station ID • Month/Year • Message—Display Filtering • Message ID Filtering Depend on Position 	<ul style="list-style-type: none"> • Station—Display Filtering: Off • Station ID: Remain • Month/Year: All On • Message—Display Filtering: Off • Message ID: Remain Filtering Depend on Position: Off

*1 White/Black interchanges under the following conditions.

In Day1/Day2 (or Day), Black, in Day3/Dusk/Night, White

*2 When the preferences is loaded and the value of the Safety Contour that is less than the MIN Safety Contour, the value of the MIN Safety Contour is used as the Safety Contour.

Also, the value of the Safety Contour saved for the preferences is not overwrite.

For details about how to set the Own ship's parameters, refer to "19.3.4 Setting own ship's parameters".

Task "Collision avoidance"

Item saved	Preferences save target		Factory setting value, value and action when Set Default button is pressed
	Location	Item	
Gain and anti-clutter functions	RADAR screen - Radar signal information	<ul style="list-style-type: none"> • Reception sensitivity adjustment value (Gain) • Sea clutter adjustment value (Sea) • Sea clutter rejection mode • Rain/snow clutter adjustment (Rain) • Rain/snow clutter rejection mode 	<ul style="list-style-type: none"> • Reception sensitivity adjustment value (Gain): 80 • Sea clutter adjustment value (Sea): 40 • Sea clutter rejection mode: AUTO • Rain/snow clutter adjustment (Rain): 50 • Rain/snow clutter rejection mode: AUTO
Tuning	RADAR screen - Radar system information	<ul style="list-style-type: none"> • Tuning mode AUTO/MAN • Fine tuning value (under MAN) 	<ul style="list-style-type: none"> • Tuning mode AUTO/MAN: AUTO • Fine tuning value (under MAN): 0
Range	RADAR screen - Presentation mode information	<ul style="list-style-type: none"> • Range scale 	6NM
Fixed rings	RADAR screen - Presentation mode information	<ul style="list-style-type: none"> • Range rings display On/Off 	Off
AIS Lost Alarm	Alert - Collision Avoidance - AIS Lost Alarm	<ul style="list-style-type: none"> • AIS Lost Alarm • AIS Lost Alarm detection target setting On/Off 	Off
VRMs	RADAR screen - EBL/VRM read information area	<ul style="list-style-type: none"> • VRM1 (VRM2) • Display On/Off • Control right • Distance value • EBL1/VRM1 measurement reference point (blank space/C/D and floating position. In the case of C, the information is stored in the form of DC coordinate and in the case of D, the information is stored in the form of latitude/longitude.) • Unit of VRM distance (commonly applied to both VRM1 and VRM2) 	<p>VRM1:</p> <ul style="list-style-type: none"> • Display On/Off: On • Control right: On • Distance value: 0.25NM • EBL1/VRM1 measurement reference point: Blank space (CCRP) <p>VRM2: Display Off</p> <ul style="list-style-type: none"> • Unit of VRM distance: NM

Item saved	Preferences save target		Factory setting value, value and action when Set Default button is pressed
	Location	Item	
EBLs	RADAR screen - EBL/VRM read information area	RADAR screen - EBL/VRM read information area EBL1 (EBL2) • Display On/Off • Control right • Bearing value • EBL bearing True/Relative (commonly applied to both EBL1 and EBL2)	EBL1 • Display On/Off: On • Control right: On • Bearing value: 000.0 • EBL bearing True/Relative: True
Parallel index lines	RADAR screen - PI (Parallel Index)	RADAR screen – PI (Parallel Index) • Display On/Off • Control right PI measurement reference point (blank space/C/D and floating position. In the case of C, the information is stored in the form of DC coordinate and in the case of D, the information is stored in the form of latitude/longitude.)	• Display On/Off: On • Control right: Off • Bearing value: 0° • Interval: 0.5NM Display for All Lines: On Mode: All Unit: NM Operation Area: One Side Floating: Off Heading Link: Off Reference Bearing: True
Display mode of the radar picture	RADAR screen - Presentation mode information	• Motion mode • Bearing mode	True motion North-up TM reset position
Stabilization Sea/Ground	RADAR screen - Presentation mode information	• Stabilization mode (combo box)	Sea
Off-centring	RADAR screen - Presentation mode information	• Off-Centre button→Off-Center On/Off status and Off-Center DC position	Off-center: Off=On center
Target trails	RADAR screen - Other ship's information	• Trail true/relative • Trail length	• Trail true/relative: True • Trail length: 6min
Past positions	RADAR screen - Other ship's information	• Past POSN	Off

Item saved	Preferences save target		Factory setting value, value and action when Set Default button is pressed
	Location	Item	
Vector mode	RADAR screen - Other ship's information	• Vector/past position true/relative	Relative
Vector time	RADAR screen - Other ship's information	Vector Length	6min
Automatic radar target acquisition	Alert - New Target Alarm	<ul style="list-style-type: none"> • AZ1 function On/Off • AZ1 Start Angle value • AZ1 End Angle value • AZ1 Start Distance value • AZ1 End Distance value • AZ2 function On/Off • AZ2 Start Angle value • AZ2 End Angle value • AZ2 Start Distance value • AZ2 End Distance value 	<ul style="list-style-type: none"> • AZ1 function On/Off: Off • AZ1 Start Angle value: 315.0° • AZ1 End Angle value: 045.0° • AZ1 Start Distance value: 3.00NM • AZ1 End Distance value: 3.50NM • AZ2 function On/Off: Off • AZ2 Start Angle value: 135.0° • AZ2 End Angle value: 225.0° • AZ2 Start Distance value: 3.00NM • AZ2 End Distance value: 3.50NM
Graphical AIS reported target display	View - Options - Target	<ul style="list-style-type: none"> • AIS Symbol display On/Off • Sleeping Class A, Class B 	<ul style="list-style-type: none"> • AIS Symbol display On/Off: On • Sleeping Class A, Class B: Off
Radar and AIS Target fusion	Settings - TT/AIS - Association	<ul style="list-style-type: none"> • Association function On/Off • TT/AIS Priority 	<ul style="list-style-type: none"> • Association function On/Off: On • TT/AIS Priority: AIS
Collision warning	RADAR screen - Other ship's information (Vector/Past POSN/Limit/Trails)	<ul style="list-style-type: none"> • CPA limit • TCPA limit 	<ul style="list-style-type: none"> • CPA limit: 2.0NM • TCPA limit: 12min

Another default settings (excepts preference) are below.

Default Setting Item	Default Setting target		Factory setting value, value and action when Set Default button is pressed
	Location	Item	
Radar image Overlay	ECDIS—Bottom bar	• Radar Echo Image	• Radar echo image: Off
AIS function button	ECDIS—Bottom bar	• AIS display On/Off	• AIS display: On
TT1/TT2 function button	ECDIS—Bottom bar	• TT1/TT2 display On/Off	• TT1/TT2 display: On
Multi View	View—Multiview	• Multi view window other than Single View window	• Multi view window other than Single View window: Single View
Edit User Map	User Map Editor	• Edit dialog	• Edit dialog: Exit
Edit Manual Update	Manual Update Editor	• Edit dialog	• Edit dialog: Exit
Route planning	Route planning dialog	• Edit dialog	• Edit dialog: Exit
Route monitoring	Route monitoring	• Route monitoring start • Route monitoring dialog • Voyage Information	• Load latest route plan • Route monitoring dialog: Close • Voyage Information: Move to bottom-right
Cursor Readout	Cursor Readout	• Cursor Readout	• Move to bottom-right • Open
MOB	MOB	• Cursor Readout	• Move to bottom-right
Display of charts	View—Options—Chart Display	• Chart Load	• AUTO
Chart Maintenance	Chart Maintenance	• Chart Maintenance dialog	• Chart Maintenance dialog: Exit
SelfTest	Maintenance—Diagnosis	• Diagnosis dialog	• Diagnosis dialog: Exit
CONNING block	Common Information Window	• CONNING block overlay	• CONNING block overlay: Exit
Chart 1	ECDIS display	• Chart drawing (Chart 1 chart)	• Chart drawing (Chart 1 chart): Exit

18.23 Setting Screen Capture

Select [Screen capture] in the classification pane.

Set the screen capture in the setting dialog of the edit pane.

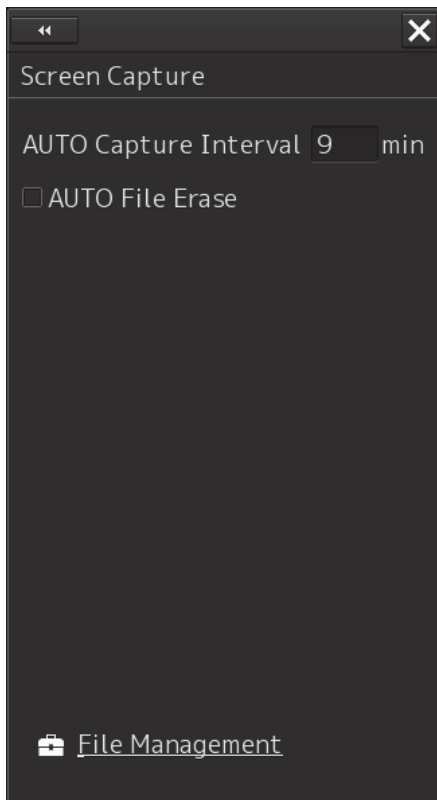

Setting Item	Description of Setting	Setting Value
AUTO Capture Interval	Set up the interval at which the Screen Capture dialog box is automatically saved. If this is set to 0, the Screen Capture dialog box will not automatically be saved.	0 to 999 min
AUTO File Erase	Specify whether or not to delete the screen shot file automatically.	To enable: Select. To disable: Clear.

Shortcut	Settings Dialog Box
File Management	[File Management] dialog box

アスベストは使用しておりません
Not use the asbestos

For further information, contact:



Japan Radio Co., Ltd.

Since 1915

URL Head office : <http://www.jrc.co.jp/eng/>

Marine Service Department

1-7-32 Tatsumi, Koto-ku, Tokyo 135-0053, Japan

e-mail : tmsc@jrc.co.jp

One-call : +81-50-3786-9201

ISO 9001, ISO 14001 Certified